

# KRAMER



## USER MANUAL

**MODEL:**

**RC-43SL**

6-Button Room Controller



## RC-43SL Quick Start Guide

This guide helps you install and use your **RC-43SL** for the first time. For more detailed information, go to <http://www.kramerav.com/manual/RC-43SL> to download the latest manual or scan the QR code on the left.

---

### Step 1: Check what's in the box

- ✓ RC-43SL 6-Button Room Controller
- ✓ 2 Cover plates (black & white)
- ✓ 1 Screwdriver
- ✓ 1 Power adapter (12V DC)
- ✓ 1 Button labels
- ✓ 1 Quick start guide
- ✓ 1 Power cord

---

### Step 2: Assemble the RC-43SL

#### 1. Orient the controller.

Make sure that the tab on the bracket is pointing downward and the numbers on the controller are right-side-up. The button LEDs are on the upper right side of each keypad.



#### 2. Choose the keys with the desired labels and insert them into the cover plate.

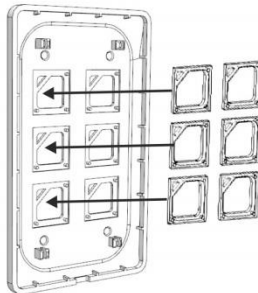

---

### Step 3: Connect the RC-43SL

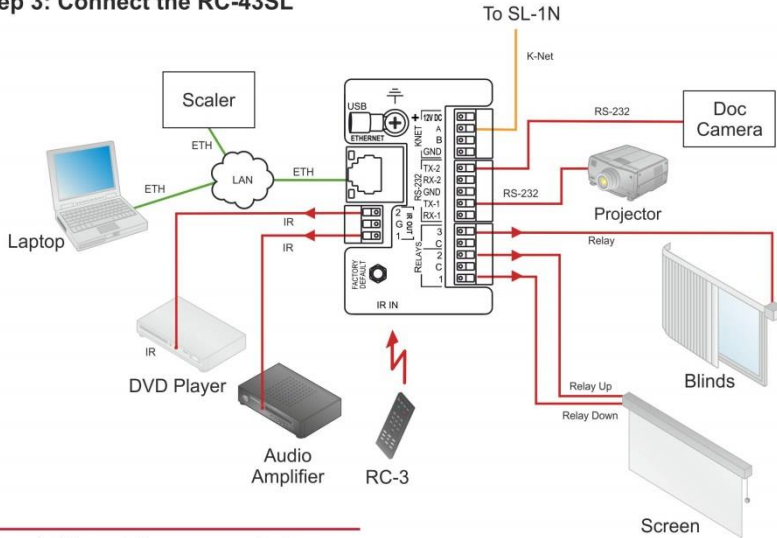

---

### Step 4: Mount the connected RC-43SL in the wall box

Screw the mounting bracket with the attached controller into the wall box with the supplied screws.

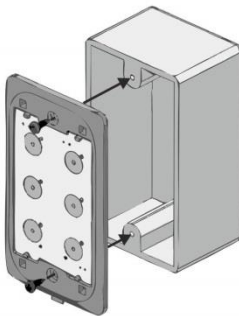

---

### Step 5: Attach the cover plate

Press the cover plate populated with labeled keys into the mounting bracket.

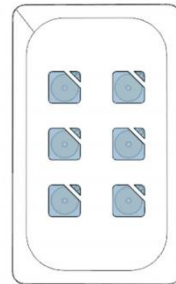

---

### Step 6: Configure the RC-43SL

Configure the unit using Kramer **K-Config** configuration software. Download the software from the Kramer Web site: [http://www.kramerelectronics.com/support/product\\_downloads.asp](http://www.kramerelectronics.com/support/product_downloads.asp)

# Contents

<b>1</b>	<b>Introduction</b>	<b>1</b>
<b>2</b>	<b>Getting Started</b>	<b>2</b>
2.1	Achieving the Best Performance	2
2.2	Safety Instructions	2
2.3	Recycling Kramer Products	3
<b>3</b>	<b>Overview</b>	<b>4</b>
3.1	Defining the RC-43SL 6-Button Room Controller	5
<b>4</b>	<b>Connecting the RC-43SL</b>	<b>6</b>
4.1	Connecting the RS-232 Port	7
4.2	Connecting the Ethernet Port	8
4.3	Connecting the K-NET Port	8
4.4	Installing the Front Panel Buttons	9
4.5	Installing the RC-43SL in the Wall Mounting Box	10
<b>5</b>	<b>Configuring the RC-43SL</b>	<b>11</b>
<b>6</b>	<b>Technical Specifications</b>	<b>12</b>

## Figures

Figure 1:	RC-43SL 6-Button Room Controller	5
Figure 2:	Connecting the RC-43SL 6-Button Room Controller	7
Figure 3:	RS-232 Connection	7
Figure 4:	K-NET Pinout Connection	8
Figure 5:	Mounting the RC-43SL in a Wall Box	10

---

# 1 Introduction

Welcome to Kramer Electronics! Since 1981, Kramer Electronics has been providing a world of unique, creative, and affordable solutions to the vast range of problems that confront video, audio, presentation, and broadcasting professionals on a daily basis. In recent years, we have redesigned and upgraded most of our line, making the best even better!

Our 1,000-plus different models now appear in 14 groups that are clearly defined by function: GROUP 1: Distribution Amplifiers; GROUP 2: Switchers and Routers; GROUP 3: Control Systems; GROUP 4: Format/Standards Converters; GROUP 5: Range Extenders and Repeaters; GROUP 6: Specialty AV Products; GROUP 7: Scan Converters and Scalers; GROUP 8: Cables and Connectors; GROUP 9: Room Connectivity; GROUP 10: Accessories and Rack Adapters; GROUP 11: Sierra Video Products; GROUP 12: Digital Signage; GROUP 13: Audio; and GROUP 14: Collaboration.

Congratulations on purchasing your Kramer **RC-43SL 6-Button Room Controller**, which is ideal for the following typical applications:

- Controlling multimedia rooms, such as classrooms, auditoriums, conference rooms, and so on

---

## 2 Getting Started

We recommend that you:

- Unpack the equipment carefully and save the original box and packaging materials for possible future shipment
- Review the contents of this user manual



Go to [www.kramerav.com/downloads/RC-43SL](http://www.kramerav.com/downloads/RC-43SL) to check for up-to-date user manuals, application programs, and to check if firmware upgrades are available (where appropriate).

### 2.1 Achieving the Best Performance

To achieve the best performance:

- Use only good quality connection cables (we recommend Kramer high-performance, high-resolution cables) to avoid interference, deterioration in signal quality due to poor matching, and elevated noise levels (often associated with low quality cables)
- Do not secure the cables in tight bundles or roll the slack into tight coils
- Avoid interference from neighbouring electrical appliances that may adversely influence signal quality
- Position your **RC-43SL** away from moisture, excessive sunlight and dust



This equipment is to be used only inside a building. It may only be connected to other equipment that is installed inside a building.

### 2.2 Safety Instructions



**Caution:** There are no operator serviceable parts inside the unit

**Warning:** Use only the Kramer Electronics power supply that is provided with the unit

**Warning:** Disconnect the power and unplug the unit from the wall before installing

## 2.3 Recycling Kramer Products

The Waste Electrical and Electronic Equipment (WEEE) Directive 2002/96/EC aims to reduce the amount of WEEE sent for disposal to landfill or incineration by requiring it to be collected and recycled. To comply with the WEEE Directive, Kramer Electronics has made arrangements with the European Advanced Recycling Network (EARN) and will cover any costs of treatment, recycling and recovery of waste Kramer Electronics branded equipment on arrival at the EARN facility. For details of Kramer's recycling arrangements in your particular country go to our recycling pages at <http://www.kramerelectronics.com/support/recycling/>.

---

## 3 Overview

The **RC-43SL** is a highly versatile, all-in-one extended remote control panel for control of AV equipment—especially projectors and associated equipment—in any room (such as classrooms, boardrooms, or auditoriums). It streamlines operations and simplifies control by integrating audio, video, and computer-video sources into a centralized system. It features a keypad with six touch-sensitive, backlit buttons.

Using the Kramer **K-Config** software, each button on the **RC-43SL** can be programmed on the room controller with a function, where each function can combine multiple individual actions.

The **RC-43SL** features:

- 6 touch-sensitive, backlit buttons with indicator LEDs
- 2 bidirectional RS-232 ports to control AV equipment such as projectors, LCD and PDP displays, power amplifiers, switchers and scalers
- 3 relay contact closure ports for controlling other room items such as raising and lowering drapes, the screen or the projector.
- IR control - 2 outputs (terminals blocks), 1 sensor
- IR learning with one sensor that learns commands from any IR remote
- A K-NET™ control channel for connecting compatible user interfaces and supplying power and control data over a single cable
- A USB port for loading device firmware
- Configures with **K-Config** software
- Compatibility with Kramer **Site-CTRL**™ software for network remote control and management over the Ethernet port
- 1 gang US wall plate size



### 3.1 Defining the RC-43SL 6-Button Room Controller

This section defines the **RC-43SL**.

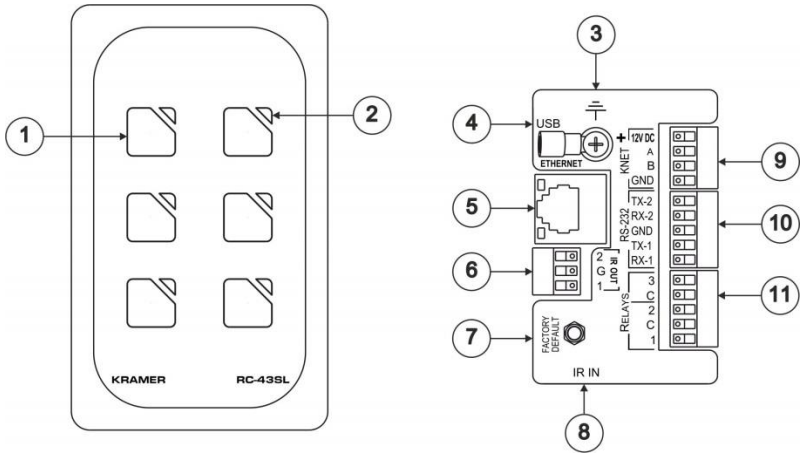

Figure 1: RC-43SL 6-Button Room Controller

#	Feature	Function
1	Six Touch-sensitive Buttons	Program button functions on the connected room controller
2	Six LEDs	Flash yellow when the button is touched. Each LED can be custom programmed to light on specific actions
3	Ground Terminal Connector	Connects to ground to earth the device
4	USB Connector	Connects to a computer for unit configuration and firmware upgrading
5	ETHERNET RJ-45 Connector	Connects to the PC or other LAN device through a networking LAN
6	IR OUT Terminal Blocks	Connect to IR emitter cables (from 1 to 2)
7	FACTORY DEFAULT Button	Using a small screwdriver, press to perform a factory reset
8	IR IN Sensor	Used for IR learning
9	K-NET Terminal Block	PIN +12V is for powering this (and another) unit, PIN A (+) PIN and PIN B (-) are for RS-485, PIN GND is for the ground connection The ground connection is sometimes connected to the shield of the RS-485 cable To supply 12V to another device, connect its 12V power line to the +12V DC terminal of this device
10	RS-232 Terminal Blocks	Connect to the RS-232 devices (from 1 to 2)
11	RELAYS Terminal Blocks	Connect to low-voltage relay-driven devices (from 1 to 3)

---

## 4 Connecting the RC-43SL



Always switch off the power to each device before connecting it to your **RC-43SL**. After connecting your **RC-43SL**, connect its power and then switch on the power to each device.



You do not have to connect all the inputs and outputs, connect only those that are required.

To connect the **RC-43SL** as illustrated in the example in [Figure 2](#):

1. Connect the RELAY terminal block connectors as follows:
  - Connect RELAY 1 and 2 to blinds
  - Connect RELAY 3 to a screen
2. Connect the IR outputs as follows:
  - Connect IR OUTPUT 1 to DVD player 1
  - Connect IR OUTPUT 2 to DVD player 2
3. Connect the RS-232 ports as follows:
  - Connect RS-232 port 1 to a projector
  - Connect RS-232 port 2 to a display
4. Connect the Ethernet port to a network.
5. Connect the K-NET port to any **RC** device (in this example, an **RC-63D**) over K-NET.

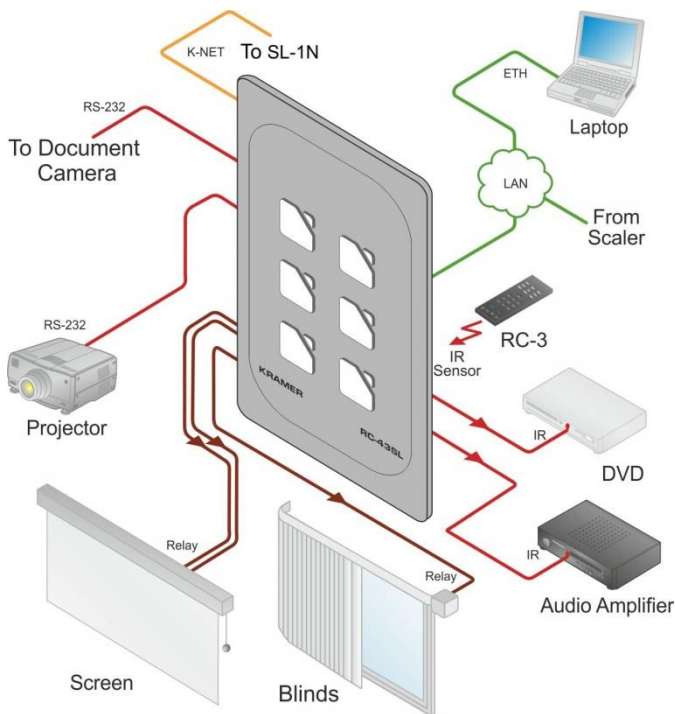

Figure 2: Connecting the RC-43SL 6-Button Room Controller

## 4.1 Connecting the RS-232 Port

To connect an AV device to the **RC-43SL**, connect the RS-232 9-pin D-sub port on your device to the RS-232 terminal block on the rear panel of the **RC-43SL** controller as shown in [Figure 3](#):

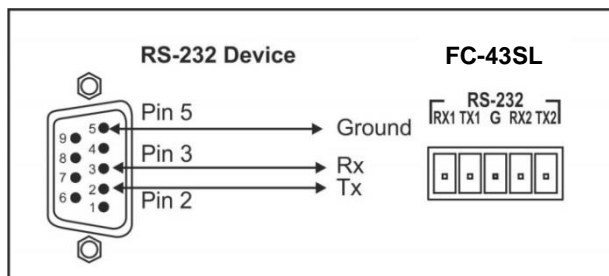

Figure 3: RS-232 Connection

## 4.2 Connecting the Ethernet Port

The Ethernet connection of the **RC-43SL** allows you to perform all control functions of the **RC-43SL** over the Internet using a PC running the Kramer **Site-CTRL** control program.

To connect the **RC-43SL** to a network:

1. Connect the Ethernet port of the **RC-43SL** to the Ethernet port on a network hub or network router, via a straight cable with RJ-45 connectors.
2. Over the network, connect to a PC running **Site-CTRL**.

After connecting the Ethernet port, you have to install and configure it. For detailed instructions on how to install and configure your Ethernet port, see the K-Config *Configuration Guide* available for download at the Kramer Web site:

[www.kramerelectronics.com](http://www.kramerelectronics.com).

## 4.3 Connecting the K-NET Port

The K-NET port is wired as shown in [Figure 4](#).

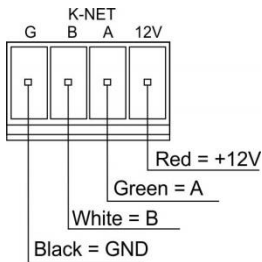

Figure 4: K-NET Pinout Connection

## 4.4 Installing the Front Panel Buttons

The **RC-43SL** is supplied with preprinted buttons from which you can choose the six that best represent the functions you wish to assign the buttons.

### To install the front panel buttons:

1. Remove the cover plate by carefully prying it away from the printed circuit board (PCB) frame using a small screwdriver being careful not to damage it.
2. Remove the stock buttons from the front panel.
3. Insert the buttons into the front panel taking care to ensure that they are oriented correctly.
4. Place the PCB and frame onto the front panel ensuring that the mounting orientation tongue is in line with the cutout on the front panel.
5. Press the front panel and PCB frame together securely.

## 4.5 Installing the RC-43SL in the Wall Mounting Box

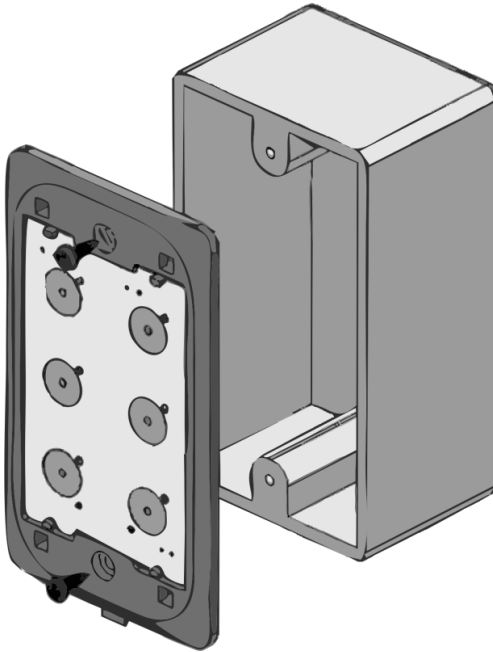

Figure 5: Mounting the RC-43SL in a Wall Box

### To install the RC-43SL in the wall mounting box:

1. Remove the cover plate of the **RC-43SL**.
2. Insert the **RC-43SL** into the wall mounting box and secure it using the two M3 x 10mm screws supplied.
3. Replace the front panel of the **RC-43SL**.

---

## 5 Configuring the RC-43SL

Configure the unit using Kramer **K-Config** configuration software. Download the software from the Kramer Web site:

[http://www.kramerelectronics.com/support/product\\_downloads.asp](http://www.kramerelectronics.com/support/product_downloads.asp)

## 6 Technical Specifications

PORTS:	2 RS-232 and K-NET on terminal block connectors, 1 Ethernet on an RJ-45 connector, 1 USB for programming, 1 built-in IR sensor (for learning)
OUTPUTS:	2 IR-out and 3 relays (30V, 1A maximum on non-inductive load) on terminal block connectors
DEFAULT IP SETTINGS:	IP number: 192.168.1.39; Mask: 255.255.0.0; Gateway: 0.0.0.0.
POWER CONSUMPTION:	12V DC, 100mA
OPERATING TEMPERATURE:	0° to +40°C (32° to 104°F)
STORAGE TEMPERATURE:	-40° to +70°C (-40° to 158°F)
HUMIDITY:	10% to 90%, RHL non-condensing
DIMENSIONS:	6.9cm x 3.9cm x 11.4cm (2.7" x 1.5" x 4.5") W, D, H.
WEIGHT:	0.1 kg (0.22lb)
SHIPPING DIMENSIONS	6.9cm x 1.6cm x 11.4cm (2.72" x 0.63" x 4.5") W, D, H (US)
SHIPPING WEIGHT:	0.5kg (1.2lbs) approx.
INCLUDED ACCESSORIES:	1 power adapter 12V DC, 1 power cord, 2 cover plates (black & white), 1 set of button labels, 1 screwdriver, 2 screws
OPTIONAL:	External IR receiver (C-A35M/IRR-50) and IR receiver extension cables (C-A35M/A35F-50).
Specifications are subject to change without notice For the most updated resolution list, go to our Web site at <a href="http://www.kramerelectronics.com">http://www.kramerelectronics.com</a>	



## LIMITED WARRANTY

The warranty obligations of Kramer Electronics for this product are limited to the terms set forth below:

### What is Covered

This limited warranty covers defects in materials and workmanship in this product.

### What is Not Covered

This limited warranty does not cover any damage, deterioration or malfunction resulting from any alteration, modification, improper or unreasonable use or maintenance, misuse, abuse, accident, neglect, exposure to excess moisture, fire, improper packing and shipping (such claims must be presented to the carrier), lightning, power surges, or other acts of nature. This limited warranty does not cover any damage, deterioration or malfunction resulting from the installation or removal of this product from any installation, any unauthorized tampering with this product, any repairs attended by anyone unauthorized by Kramer Electronics to make such repairs, or any other cause which does not relate directly to a defect in materials and/or workmanship of this product. This limited warranty does not cover cartons, equipment enclosures, cables or accessories used in conjunction with this product.

Without limiting any other exclusion herein, Kramer Electronics does not warrant that the product covered hereby, including, without limitation, the technology and/or integrated circuit(s) included in the product, will not become obsolete or that such items are or will remain compatible with any other product or technology with which the product may be used.

### How Long Does this Coverage Last

Seven years as of this printing; please check our Web site for the most current and accurate warranty information.

### Who is Covered

Only the original purchaser of this product is covered under this limited warranty. This limited warranty is not transferable to subsequent purchasers or owners of this product.

### What Kramer Electronics will do

Kramer Electronics will, at its sole option, provide one of the following three remedies to whatever extent it shall deem necessary to satisfy a proper claim under this limited warranty:

1. Elect to repair or facilitate the repair of any defective parts within a reasonable period of time, free of any charge for the necessary parts and labor to complete the repair and restore this product to its proper operating condition. Kramer Electronics will also pay the shipping costs necessary to return this product once the repair is complete.
2. Replace this product with a direct replacement or with a similar product deemed by Kramer Electronics to perform substantially the same function as the original product.
3. Issue a refund of the original purchase price less depreciation to be determined based on the age of the product at the time remedy is sought under this limited warranty.

### What Kramer Electronics will not do Under This Limited Warranty

If this product is returned to Kramer Electronics or the authorized dealer from which it was purchased or any other party authorized to repair Kramer Electronics products, this product must be insured during shipment, with the insurance and shipping charges prepaid by you. If this product is returned uninsured, you assume all risks of loss or damage during shipment. Kramer Electronics will not be responsible for any costs related to the removal or re-installation of this product from or into any installation. Kramer Electronics will not be responsible for any costs related to any setting up this product, any adjustment of user controls or any programming required for a specific installation of this product.

### How to Obtain a Remedy under this Limited Warranty

To obtain a remedy under this limited warranty, you must contact either the authorized Kramer Electronics reseller from whom you purchased this product or the Kramer Electronics office nearest you. For a list of authorized Kramer Electronics resellers and/or Kramer Electronics authorized service providers, please visit our web site at [www.kramerelectronics.com](http://www.kramerelectronics.com) or contact the Kramer Electronics office nearest you.

In order to pursue any remedy under this limited warranty, you must possess an original, dated receipt as proof of purchase from an authorized Kramer Electronics reseller. If this product is returned under this limited warranty, a return authorization number, obtained from Kramer Electronics, will be required. You may also be directed to an authorized reseller or a person authorized by Kramer Electronics to repair the product.

If it is decided that this product should be returned directly to Kramer Electronics, this product should be properly packed, preferably in the original carton, for shipping. Cartons not bearing a return authorization number will be refused.

### Limitation on Liability

THE MAXIMUM LIABILITY OF KRAMER ELECTRONICS UNDER THIS LIMITED WARRANTY SHALL NOT EXCEED THE ACTUAL PURCHASE PRICE PAID FOR THE PRODUCT. TO THE MAXIMUM EXTENT PERMITTED BY LAW, KRAMER ELECTRONICS IS NOT RESPONSIBLE FOR DIRECT, SPECIAL, INCIDENTAL OR CONSEQUENTIAL DAMAGES RESULTING FROM ANY BREACH OF WARRANTY OR CONDITION, OR UNDER ANY OTHER LEGAL THEORY. Some countries, districts or states do not allow the exclusion or limitation of relief, special, incidental, consequential or indirect damages, or the limitation of liability to specified amounts, so the above limitations or exclusions may not apply to you.

### Exclusive Remedy

TO THE MAXIMUM EXTENT PERMITTED BY LAW, THIS LIMITED WARRANTY AND THE REMEDIES SET FORTH ABOVE ARE EXCLUSIVE AND IN LIEU OF ALL OTHER WARRANTIES, REMEDIES AND CONDITIONS, WHETHER ORAL OR WRITTEN, EXPRESS OR IMPLIED. TO THE MAXIMUM EXTENT PERMITTED BY LAW, KRAMER ELECTRONICS SPECIFICALLY DISCLAIMS ANY AND ALL IMPLIED WARRANTIES, INCLUDING WITHOUT LIMITATION, WARRANTIES OF MERCHANTABILITY AND FITNESS FOR A PARTICULAR PURPOSE. IF KRAMER ELECTRONICS CANNOT LAWFULLY DISCLAIM OR EXCLUDE IMPLIED WARRANTIES UNDER APPLICABLE LAW, THEN ALL IMPLIED WARRANTIES COVERING THIS PRODUCT, INCLUDING WARRANTIES OF MERCHANTABILITY AND FITNESS FOR A PARTICULAR PURPOSE, SHALL APPLY TO THIS PRODUCT AS PROVIDED UNDER APPLICABLE LAW.

IF ANY PRODUCT TO WHICH THIS LIMITED WARRANTY APPLIES IS A "CONSUMER PRODUCT" UNDER THE MAGNUSON-MOSS WARRANTY ACT (15 U.S.C.A. §2301, ET SEQ.) OR OTHER APPLICABLE LAW, THE FOREGOING DISCLAIMER OF IMPLIED WARRANTIES SHALL NOT APPLY TO YOU, AND ALL IMPLIED WARRANTIES ON THIS PRODUCT, INCLUDING WARRANTIES OF MERCHANTABILITY AND FITNESS FOR THE PARTICULAR PURPOSE, SHALL APPLY AS PROVIDED UNDER APPLICABLE LAW.

### Other Conditions

This limited warranty gives you specific legal rights, and you may have other rights which vary from country to country or state to state.

This limited warranty is void if (i) the label bearing the serial number of this product has been removed or defaced, (ii) the product is not distributed by Kramer Electronics or (iii) this product is not purchased from an authorized Kramer Electronics reseller. If you are unsure whether a reseller is an authorized Kramer Electronics reseller, please visit our Web site at [www.kramerelectronics.com](http://www.kramerelectronics.com) or contact a Kramer Electronics office from the list at the end of this document.

Your rights under this limited warranty are not diminished if you do not complete and return the product registration form or complete and submit the online product registration form. Kramer Electronics thanks you for purchasing a Kramer Electronics product. We hope it will give you years of satisfaction.

# KRAMER



## SAFETY WARNING

Disconnect the unit from the power supply before opening and servicing

For the latest information on our products and a list of Kramer distributors, visit our Web site to find updates to this user manual.

We welcome your questions, comments, and feedback.

[www.kramerAV.com](http://www.kramerAV.com)  
[info@kramerel.com](mailto:info@kramerel.com)