

3G-AM Mini-Converter

3G 8-Channel AES Embedder/Disembedder

Installation & Operation Guide

Version 1.0

Published: February 20, 2015



Because it matters.®



Table of Contents

Notices	4
Trademarks	4
Copyright	4
Contacting Support	4
Chapter 1: Introduction	5
Overview	5
Features	5
3G-AM Simplified Block Diagram	6
3G-AM I/O Connections	6
User Controls	7
DIP Switches	7
MiniConfig Control	7
Installation	7
Breakout Cable Pinouts	8
Chapter 2: Operation	9
Default Operational Settings	9
DIP Switches	9
DIP Switch Settings	10
Switch 6 Embedded Channel Mapping	11
Switch 7 Disembedding Channel Mapping	12
USB Control and Setup—Using AJA MiniConfig	12
Installing MiniConfig on a Mac	12
Installing MiniConfig on a PC	12
Running MiniConfig	13
PC Startup	13
Mac Startup	13
Saving Setups	14
Operating MiniConfig	14
Tabbed Screens	15
Audio-1 Tab Screen	16
Audio-2 Tab Screen	17
Update Tab Screen	18
Software Update Procedure	19
Info Tab Screen	19
Appendix A: Specifications	21
Video Input	21
Input Formats	21
Video Output	21
Output Formats	21
Audio Inputs and Outputs	22
User Controls	22
Physical	22
Power	22
Size	22
Environment	23
Appendix B: Safety and Compliance	24
Federal Communications Commission (FCC) Compliance Notices	24

Class B Interference Statement	24
FCC Caution	24
Canadian ICES Statement	24
European Union and European Free Trade Association (EFTA) Regulatory Compliance	25
Declaration of Conformity	25
Korean KCC Compliance Statement	26
Taiwan Compliance Statement	26
Recycling Notice	26
Translated Warning and Caution Messages	26
Before Operation Please Read These Instructions	27
Warranty Information	34
Limited Warranty	34

Notices

Trademarks

AJA®, Io®, Ki Pro®, KONA®, KUMO®, T-TAP®, Because it matters.® and ROI® are registered trademarks of AJA Video Systems, Inc. in the United States. AJA and Ki Pro are trademarks of AJA Video Systems, Inc. registered in other countries. AJA Control Room™, CION™, Corvid Ultra™, FiDO™, Science of the Beautiful™, TruScale™, TruZoom™, V2Analog™ and V2Digital™ are trademarks of AJA Video Systems, Inc.

AirPort, Apple, Apple logo, AppleShare, AppleTalk, FireWire, iPod, iPod touch, Mac and Macintosh are registered trademarks of Apple Inc. Final Cut Pro, QuickTime and QuickTime logo are trademarks of Apple Inc.

Avid, Avid DNxHD and Media Composer are registered trademarks of Avid Technology, Inc.

HDMI, the HDMI logo and High-Definition Multimedia Interface are trademarks or registered trademarks of HDMI Licensing, LLC.

DVI is a registered trademark of DDWG.

TASCAM is a registered trademark of TEAC Corporation.

Dolby® and the double-D Dolby logo are registered trademarks of Dolby Laboratories Licensing Corporation.

All other trademarks are the property of their respective holders.

Copyright

Copyright © 2015 AJA Video Systems, Inc. All rights reserved. All information in this manual is subject to change without notice. No part of the document may be reproduced or transmitted in any form, or by any means, electronic or mechanical, including photocopying or recording, without the express written permission of AJA Video Systems, Inc.

Contacting Support

When calling for support, have all information at hand prior to calling.

To contact AJA for sales or support, use any of the following methods:

Telephone: +1.530.271.3190

FAX: +1.530.271.3140

Web: <http://www.aja.com>

Support Email: support@aja.com

Sales Email: sales@aja.com

Chapter 1: Introduction



Overview

The 3G-AM is a triple rate 8 channel AES audio embedder/disembedder. AES audio can be embedded and disembedded simultaneously. The embedder is user selectable, on a channel pair basis, to either “pass” existing SDI input audio or embed AES input audio from the breakout cable. The ability to pass incoming ancillary data makes it possible to embed up to 16 channels of audio by cascading two units. Horizontal ancillary data (HANC) packets in compliance with SMPTE 291M can also be dropped at the input.

The 3G-AM automatically detects and configures to the input video standard. 3G-SDI formats up to and including 2048x1080p 60 YCbCr 4:2:2 are supported (see ["Appendix A: Specifications on page 21"](#) for a complete listing). SDI video loops through the device with minimal delay. Loop through embedded SDI audio supports up to 16 channels.

NOTE: 2048x1080p/psf 29.97 and 30 formats support a maximum of 8 channels embedded audio.

Using the MiniConfig application, you can configure data packets to be passed from the AES inputs to embedded ancillary packets un-altered. This, along with minimized embed/disembed latency, ensures 100 percent compatibility with Dolby® bitstreams.

Features

- Triple rate 3G, HD, and SD-SDI embedder/disembedder
- 8 Channel AES I/O
- Supplied breakout cable for balanced AES - XLR connectors
- 1 x BNC 3G-SDI input
- 1 x BNC 3G-SDI output
- Setup via DIP switch or PC/Mac using USB port and supplied USB cable (USB configuration software application supplied on CD)
- Uses universal input +5V power supply AJA model DWP-U-R1 (included)

3G-AM Simplified Block Diagram

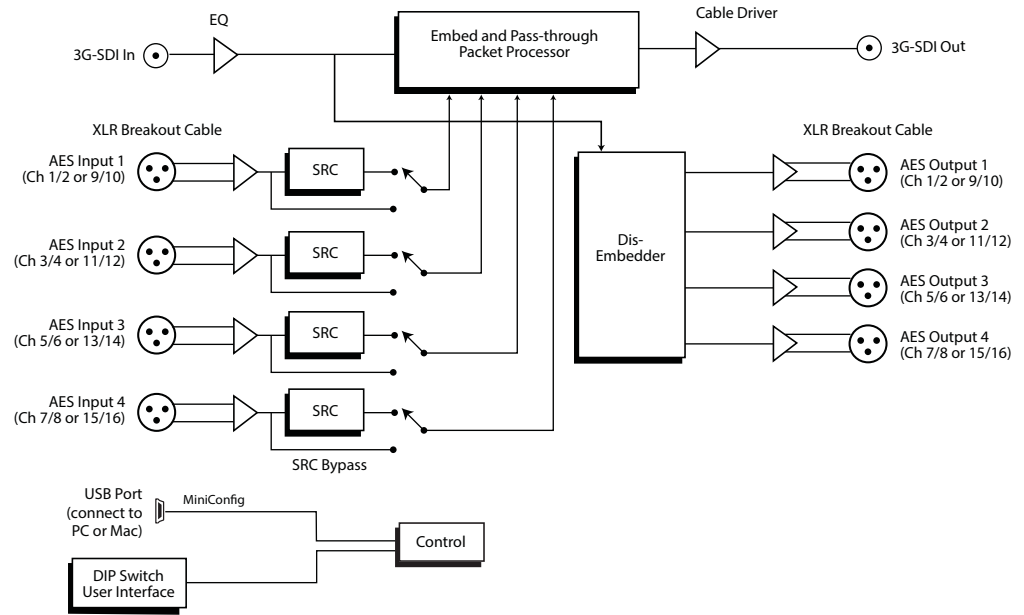

3G-AM I/O Connections



NOTE: The LED adjacent to the SDI connectors indicates by color the detected signal type. Off is no signal, Green is SD-SDI, red is HD-SDI, and amber/orange is 3G-SDI.

User Controls

DIP Switches

The 3G-AM has an 8 position DIP switch accessible through a cut-out in the bottom of the unit. The DIP switches are used to configure the unit's audio embedding and disembedding, and control ancillary data.

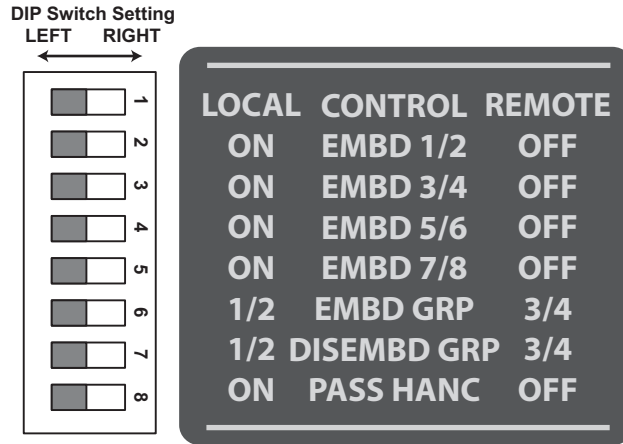

Factory default switch settings are all in the leftmost position.

The exact functions of the DIP switches are described in ["Operation" on page 9](#).

MiniConfig Control

The MiniConfig application can also be used to configure the unit's audio embedding and disembedding functions. Configuration set via MiniConfig is stored in the unit through subsequent power cycles.

Installing and using MiniConfig are described in ["DIP Switches" on page 9](#).

Installation

Typically, 3G-AM installation consists of the following steps:

1. Ensure the converter is disconnected from power.
2. Connect video equipment to the converter BNCs.
3. Connect the breakout audio cable to the converter.
4. Connect audio equipment to the breakout cable (see [Figure 1 on page 8](#)).
5. Apply power to the converter (AJA power supply included).
6. The converter will now run using the default factory settings. If you wish to alter the factory settings you can either:
 - Change the DIP switch 2 - 8 settings.
 - or -
 - Install the AJA MiniConfig software on your computer,
 - attach the converter via USB,
 - change the DIP switch 1 setting to LOCAL, and
 - make your changes using the MiniConfig setup screens.

Breakout Cable Pinouts

Figure 1. Breakout Cable Illustration

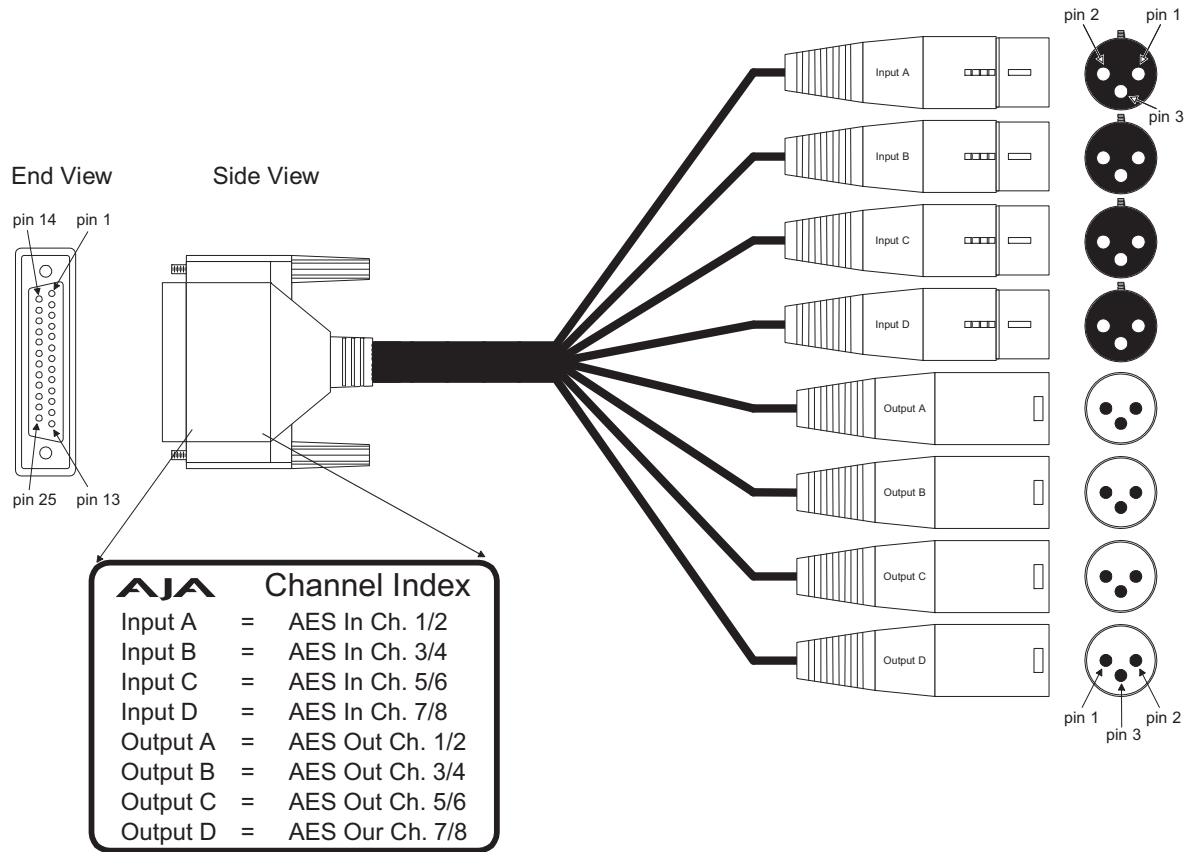

Table 1. DB25 Breakout Cable Pinouts

Pin	Function	Pin, <connector>	Pin	Function	Pin, <connector>
1	In 4 +	2, XLR Input D	14	In 4 -	3, XLR Input D
2	In 4 GND	1, XLR Input D	15	In 3 +	2, XLR Input C
3	In 3 -	3, XLR Input C	16	In 3 GND	1, XLR Input C
4	In 2+	2, XLR Input B	17	In 2 -	3, XLR Input B
5	In 2 GND	1, XLR Input B	18	In 1 +	2, XLR Input A
6	In 1 -	3, XLR Input A	19	In 1 GND	1, XLR Input A
7	Out 4 +	2, XLR Output D	20	Out 4 -	3, XLR Output D
8	Out 4 GND	1, XLR Output D	21	Out 3 +	2, XLR Output C
9	Out 3 -	3, XLR Output C	22	Out 3 GND	1, XLR Output C
10	Out 2 +	2, XLR Output B	23	Out 2 -	3, XLR Output B
11	Out 2 GND	1, XLR Output B	24	Out 1 +	2, XLR Output A
12	Out 1 -	3, XLR Output A	25	Out 1 GND	1, XLR Output A
13	NC	NC			

Chapter 2: Operation

Default Operational Settings

The 3G-AM converter ships from the factory with the following configuration:

- Local (DIP switch) control.
- Input AES audio channel pairs 1/2, 3/4, 5/6, 7/8 are embedded to SDI output channel pairs 1/2, 3/4, 5/6, 7/8, overwriting any existing embedded audio.
- Input SDI embedded audio channel pairs 1/2, 3/4, 5/6, 7/8 are disembedded to AES audio output channels 1/2, 3/4, 5/6, 7/8.
- All HANC packets pass from SDI input to output, except for embedded output audio channels 1/2, 3/4, 5/6, 7/8.

If these settings apply to your requirements, you can simply connect the video and audio input and output signal cables and power up the unit.

For other applications, you can configure the unit using its DIP switch settings, or by using the MiniConfig application and a PC or Mac via USB.

DIP Switches

The 3G-AM DIP switches configure the audio embedding and disembedding functions, and control ancillary data.

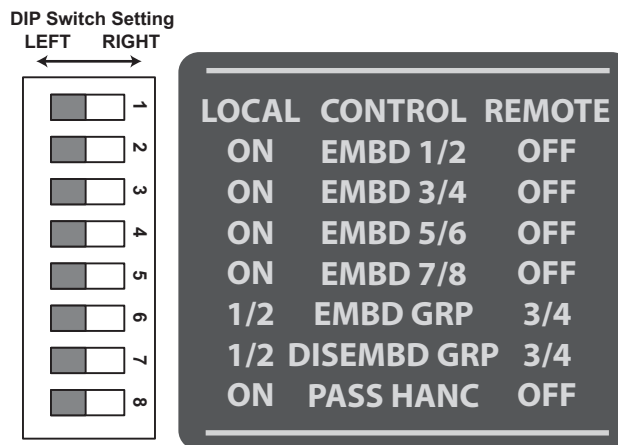

DIP Switch Settings

DIP switch settings used to configure various functions are described below.

Table 2. 3G-AM DIP Switch Setting Descriptions

SWITCH	FUNCTION	DIP Set LEFT (default)	DIP Set RIGHT
1	Control	Selects Local (DIP), and blocks MiniConfig control.	Selects Remote (MiniConfig), and disables DIP switches 2-8.
2	Audio Embedding for Channels 1/2 (EMBD 1/2)	(ON) Overwrite or embed new channel 1/2 packets.	(OFF) If AUX (SW 8) is ON : Pass any channel 1/2 packets from input SDI. If AUX (SW 8) is OFF : Delete all packets from input SDI.
3	Audio Embedding for Channels 3/4 (EMDB 3/4)	(ON) Overwrite or embed new channel 3/4 packets.	(OFF) If AUX (SW 8) is ON : Pass any channel 3/4 packets from input SDI. If AUX (SW 8) is OFF : Delete all packets from input SDI.
4	Audio Embedding for Channels 5/6 (EMDB 5/6)	(ON) Overwrite or embed new channel 5/6 packets.	(OFF) If AUX (SW 8) is ON : Pass any channel 5/6 packets from input SDI. If AUX (SW 8) is OFF : Delete all packets from input SDI.
5	Audio Embedding for Channels 7/8 (EMDB 7/8)	(ON) Overwrite or embed new channel 7/8 packets.	(OFF) If AUX (SW 8) is ON : Pass any channel 7/8 packets from input SDI. If AUX (SW 8) is OFF : Delete all packets from input SDI.
6	Channel Mapping For Embedded Groups (EMBD GRP)	Embed to Groups 1/2 as specified in 272M and 299M	Embed to Groups 3/4 as specified in 272M and 299M
		Refer to Table 3, "DIP SW 6 Embedded Channel Mapping," on page 11	
7	Channel Mapping For Disembedding Groups (DISEMBD GRP)	Disembed from Groups 1/2 as specified in 272M and 299M)	Disembed from Groups 3/4 as specified in 272M and 299M
		Refer to Table 4, "DIP SW 7 Disembedded Input Channel Mapping," on page 12	
8	Pass or Drop HANC input packets. (PASS HANC)	(ON) All incoming HANC packets are passed unless the embedder settings above require all or part of them to be over-written.	(OFF) All incoming HANC packets are dropped before embedding any new audio packets. Embedder settings above determine all embedded audio output. Disembedding is not affected.

NOTE: 2048x1080p/psf 29.97 and 30 formats support a maximum of 8 channels of embedded audio. When one of these formats is present and embedding is turned on, the PASS HANC DIP switch will be ignored and all incoming packets will be dropped before embedding any new audio packets.

Switch 6 Embedded Channel Mapping

The following table shows how switch 6 affects embedded channel mapping.

Table 3. DIP SW 6 Embedded Channel Mapping

DIP SW 6 EMBD GRP	AES Input Channel	SDI Embedded Group	SDI Embedded Output Channel
Left (1/2)	1 →	1	1
	2 →		2
	3 →		3
	4 →		4
	5 →	2	5
	6 →		6
	7 →		7
	8 →		8
Right (3/4)	1 →	3	9
	2 →		10
	3 →		11
	4 →		12
	5 →	4	13
	6 →		14
	7 →		15
	8 →		16

Switch 7 Disembedding Channel Mapping

The following table shows how switch 7 affects disembedding channel mapping.

Table 4. DIP SW 7 Disembedded Input Channel Mapping

DIP SW 7 DISEMBD GRP	SDI Embedded Input Group	SDI Embedded Input Channel	AES Output Channel
Left (1/2)	1	1 →	1
		2 →	2
		3 →	3
		4 →	4
	2	5 →	5
		6 →	6
		7 →	7
		8 →	8
Right (3/4)	3	9 →	1
		10 →	2
		11 →	3
		12 →	4
	4	13 →	5
		14 →	6
		15 →	7
		16 →	8

USB Control and Setup—Using AJA MiniConfig

The 3G-AM can usually be used right out of the box for most applications since it is designed to recognize inputs and perform standard actions automatically by default. However you can also manually configure the unit using a supplied software application for PCs and Macs called “MiniConfig.” This same application can be used to update Mini-Converter firmware released by AJA.

Installing MiniConfig on a Mac

To install the application on a Mac, insert the CD supplied with the Mini-Converter into the computer, drag the “AJA MiniConfig” application for your platform (Mac or PC) to your desktop or an applications folder.



AJA MiniConfig

NOTE: Macintosh computers must be Intel-based (G5, G4 and earlier models will not work with MiniConfig).

Installing MiniConfig on a PC

To install the application on a Windows PC, insert the CD supplied with the Mini-Converter into the computer, locate the “MiniInstaller” application, and then double-click it.

Figure 2. MiniConfig Setup Wizard on PC



A Setup Wizard will guide you through the installation. Just click Next to begin.

Answer all questions in the subsequent dialogues; when done, you will be able to locate the MiniConfig application in the AJA folder in the Programs listing.

Running MiniConfig

Connect the Mini-Converter to the PC or Mac via the supplied USB cable. Connect the external power supply (supplied) to the Mini-Converter.

PC Startup

To run MiniConfig on a PC, find the AJA MiniConfig in the program list and locate the AJA MiniConfig application.

Figure 3. PC MiniConfig Startup

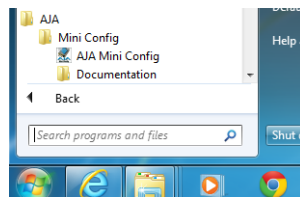

Mac Startup

To run MiniConfig on a Mac, double-click the Applications folder and locate the AJA MiniConfig application. Double-click the application to launch it.

Figure 4. Mac MiniConfig Startup

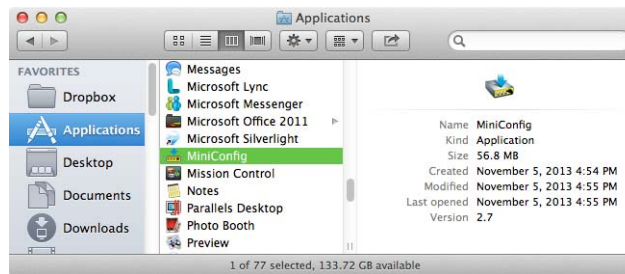

NOTE: On a Mac, when the Mini-Converter is connected to the USB port, you may see an alert like that shown below. If you do, press Cancel—this alert can be ignored.

Figure 5. Mac Network Message (ignore)

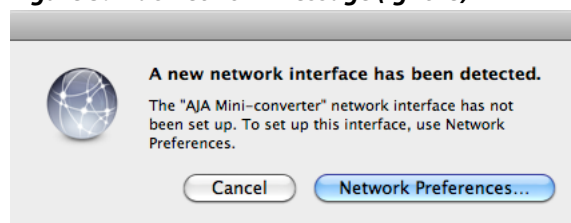

Saving Setups A *File* menu at the top of the MiniConfig application menu bar allows you to *Save* the state of the Mini-Converter, with your current settings, to a file for later recall. This allows you to set up the converter for different applications, storing each (with *Save*) to a unique name for easy recall—using the *Open* menu item. A *Revert to Factory Settings* menu item similarly allows you to change the settings back to AJA's factory defaults. An *Edit* menu allows you to cut and paste values to/from fields, just as in other applications.

Operating MiniConfig

The MiniConfig application provides a graphic interface for viewing settings and updating software. It consists of an information area at the top that shows the available Mini-Converters attached to the computer via USB, with a graphical rendering of the selected Mini-Converter showing all the connectors and their current state.

Colored text next to the connectors indicates the signal type and what the Mini-Converter is doing:

- *Blue* text indicates the values automatically selected
- *Black* text indicates values that you have manually selected
- *Red* text indicates the Mini-Converter is not detecting a signal or cannot negotiate with the attached device

NOTE: Even if no output device is detected, it still shows the signal it is outputting.

NOTE: Configuration settings in red will change based on the attached output device as well as input signals. For improved accuracy and reliability, you should configure the Mini-Converter only when the target output device is attached and input signals are supplied at the inputs.

Screens are virtually the same on both PC and Mac, with subtle differences that reflect the general look of the platform environment.

Running Multiple Mini-Converters: MiniConfig can manage multiple AJA Mini-Converters connected via USB—even when they are of differing types. However it only connects to one at a time. You can choose which Mini-Converter you wish to control using the pulldown menu in the upper right hand corner. If you want to configure and update multiple Mini-Converters in parallel, you can do it by running multiple instances of the MiniConfig application and have each control a different Mini-Converter.

Figure 6. MiniConfig Screen

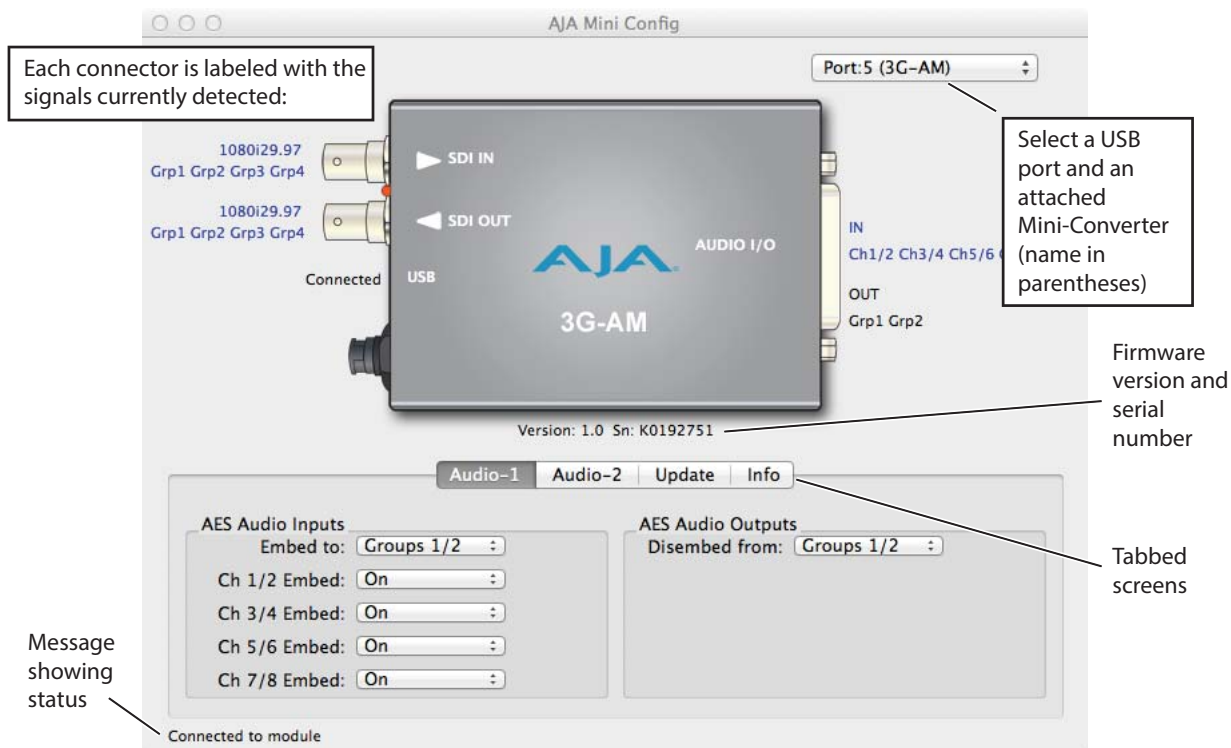

NOTE: The LED adjacent to the SDI connectors indicates by color the detected signal type. Off is no signal, Green is SD-SDI, red is HD-SDI, and amber/orange is 3G-SDI.

Selecting a Mini-Converter with the dropdown menu causes this application to connect to the selected converter. The graphic of Mini-Converter and text below it provides:

- Type of converter
- Firmware version
- Serial number of the unit

A status field at the bottom of the screen shows if your application is connected and communicating with the Mini-Converter.

When configuring the Mini-Converter, select it from the top pulldown, view the current settings and change any values. Making a change communicates that new value to the Mini-Converter's non-volatile memory.

Tabbed Screens The Tabs delineate control screens with groups of controls for each type of task to be performed. The controls for the actual configuration parameters are specific to each Mini-Converter type. Click on any of the tab buttons and the screen below will change to match. Each of these screens are described on the following pages.

Audio-1 Tab Screen

Click on the Audio-1 tab to view and make changes to the audio embedding and disembedding settings.

Figure 7. MiniConfig, Audio-1 Tab Screen

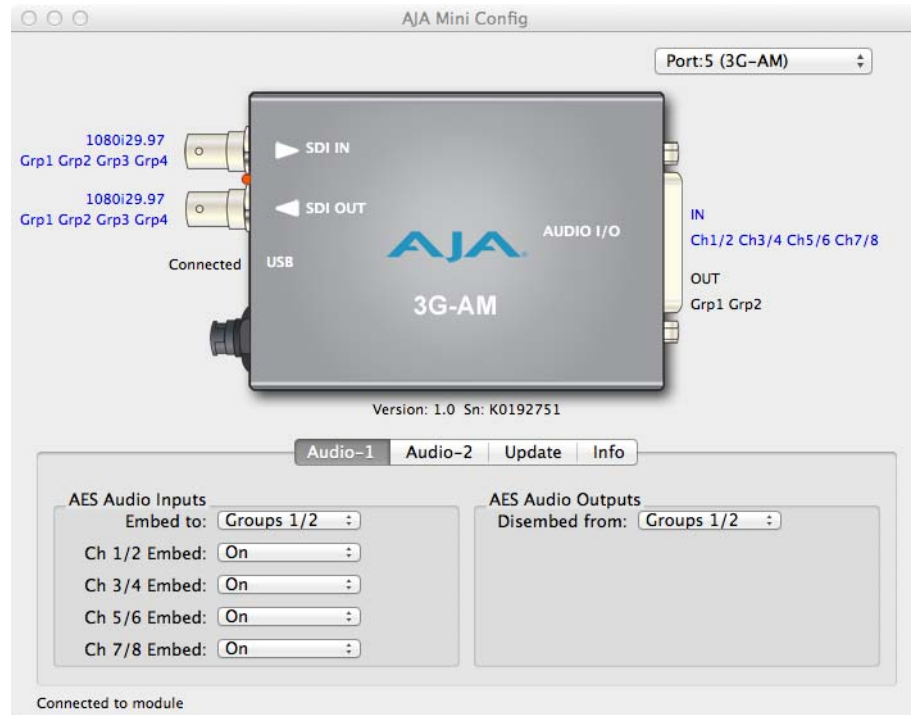

AES Audio Inputs

Embed to: Choose which SDI embedded audio groups will embed incoming AES audio:

- Groups 1/2 (Ch 1-8), or Groups 3/4 (Ch 9-16).

Ch 1-2 Embed: Selecting On embeds the AES audio Ch 1/2 pair in the first two channels of the Groups selected above.

Ch 3-4 Embed: Selecting On embeds the AES audio Ch 3/4 pair in the next two channels of the Groups selected above.

Ch 5-6 Embed: Selecting On embeds the AES audio Ch 5/6 pair in the next two channels of the Groups selected above.

Ch 7-8 Embed: Selecting On embeds the AES audio Ch 7/8 pair in the last two channels of the Groups selected above.

AES Audio Outputs

Disembed from: Choose which SDI embedded audio group will disembed its audio and send it to the four AES audio outputs:

- Group 1/2 (Ch 1-8), Group 3/4 (Ch 9-16).

Audio-2 Tab Screen

Click on the Audio-2 tab to view and make changes to the packet processing and audio level settings.

Figure 8. MiniConfig, Audio-1 Tab Screen

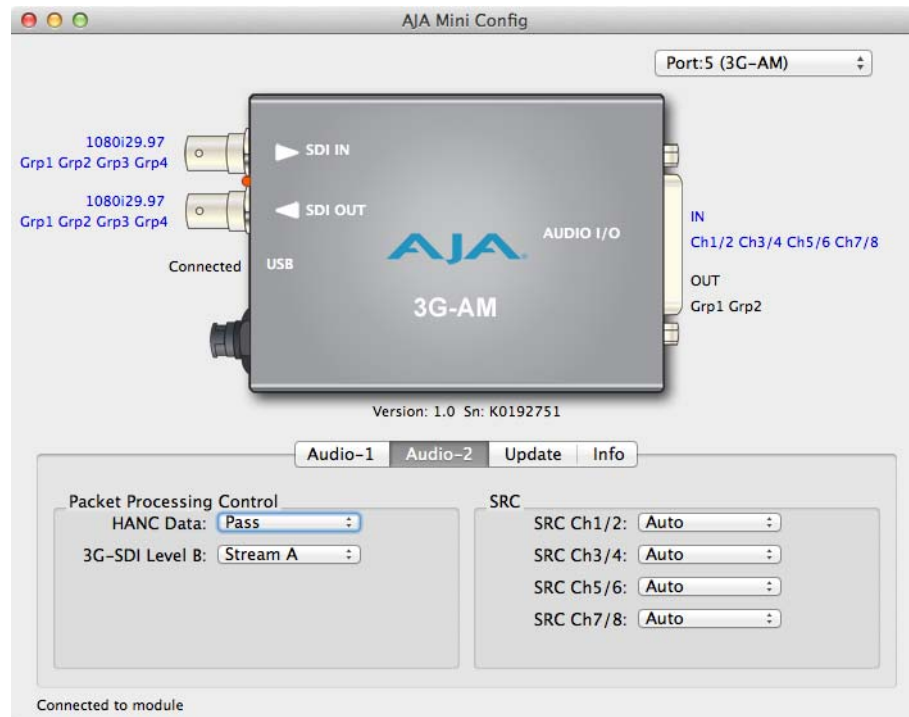

Packet Processing Control

HANC Data: When **Pass** is selected, all incoming HANC packets are passed unless the embedder settings require all or part of them to be over-written.

When **Remove** is selected, all incoming HANC packets are dropped before embedding any new audio packets. The embedder settings determine all embedded audio output. Disembedding is not affected.

NOTE: 2048x1080p/psf 29.97 and 30 formats support a maximum of 8 channels of embedded audio. When one of these formats is present and embedding is turned on, the PASS HANC setting will be ignored and all incoming packets will be dropped before embedding any new audio packets.

3G-SDI Level B: For 3G Level B signals, selects either the 16 audio channels of input **Stream A** or the 16 channels of input **Stream B** for disembedding. This setting also controls whether output Stream A or output Stream B will receive embedded audio. This control has no effect if a 3G Level B signal is not detected.

SRC This setting determines whether AES audio inputs are passed through the sample rate converter before embedding. Turn this setting Off for compatibility with non-PCM bitstreams such as Dolby-E or Dolby-B.

Choose **Auto**, **On**, or **Off** for each of the indicated input channel pairs: (Ch 1/2, Ch 3/4, Ch 5/6, Ch 7/8).

- Auto - Automatically selects whether incoming AES audio is sample rate converted. If channel status bits are detected that indicate the audio is PCM (normal digital audio), the audio will be passed through the sample rate converter. If compressed audio (such

as Dolby) bits are detected, the sample rate converter is bypassed (it would corrupt the compressed data).

- On - Pass all input AES audio through the sample rate converter before embedding (for example, for use with PCM audio). AES inputs are sample rate converted to a 48KHz rate synchronous to the video input.
- Off - Do not pass any input AES audio through the sample rate converter before embedding (for example, for use with Dolby® Digital from a synchronous source).

NOTE: For proper operation with SRC Off, the AES input timing must be externally synchronized to the input SDI.

About SRC Settings 48KHz synchronous ancillary packets are disembedded and passed unaltered to the AES outputs regardless of the SRC setting. With the SRC setting Off, data packets are passed from the AES inputs to embedded ancillary packets un-altered, according to SMPTE 337M. All AES3-2003 defined channel status bits are passed through unaltered in both the embed and dis-embed directions—except for the sample rate field, which is always set to 48KHz. The channel status CRC is re-calculated and inserted into the bitstream. This ability, along with a very small audio embed/disembed latency, ensures 100 percent compatibility with Dolby® bitstreams.

Update Tab Screen

Use this Update screen to view the software version currently installed on the converter or install new software.

Figure 9. MiniConfig, Update Screen

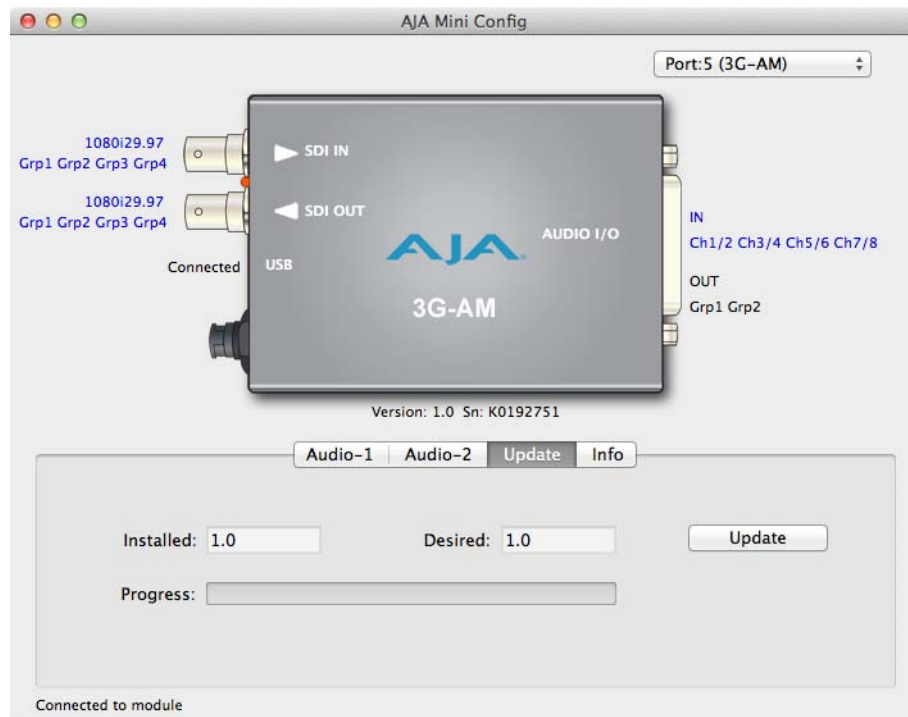

NOTE: When discussing Mini-Converters, “Firmware” is software that will be stored in the Mini-Converter’s non-volatile memory and used when it is powered up. This is something different than the MiniConfig application software. The version numbers shown in the Update screen refer only to the firmware.

The following fields and control are present in this screen:

- Installed:* This field shows the version of the firmware currently installed inside the Mini-Converter.
- Desired:* This field shows the version of firmware embedded in the MiniConfig application which you can install into the Mini-Converter by clicking the *Update* button.
- Update:* This button initiates a software update operation loading the “Desired” version of firmware into the Mini-Converter’s non-volatile memory.
- Progress:* This indicator bar shows the progress of software being installed.

Software Update Procedure

1. Check the AJA website for new MiniConfig software for your Mini-Converter. If new software is found, download it and uncompress the file archive (zip). Here is the URL to use when checking:
<http://www.aja.com/en/products/mini-converters/mini-config-software>
2. Connect the Mini-Converter to a Mac or PC via a USB port on the computer and run the new MiniConfig software just downloaded.
3. Click on the Update tab screen.
4. Check the Installed version level against the Desired version level. If the Desired is newer, then click the *Update* button to download the new firmware to the Mini-Converter.

Progress will be shown via the Progress thermometer bar, and when completed an “Update Succeeded” message appears.

Info Tab Screen

This screen provides basic information about the Mini-Converter. This information is mostly useful when calling AJA Support for service or technical support.

Figure 10. MiniConfig, Info Screen

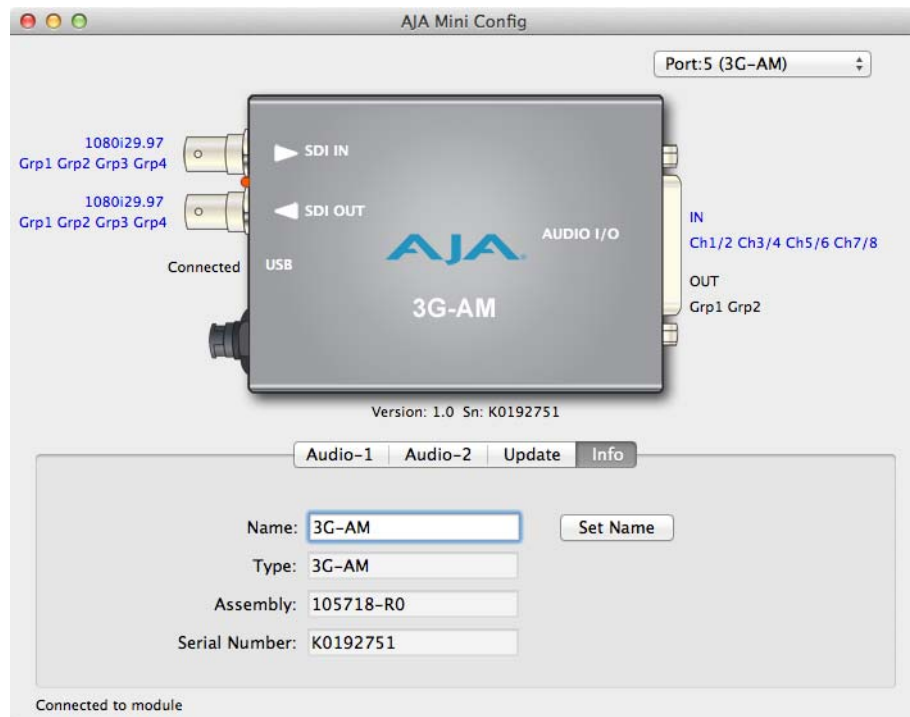

Name: This field allows you to give your Mini-Converter a name. This may be useful if you have several Mini-Converters attached to a Mac/PC via USB so you can distinguish one of them easily (especially if they're the same model).

Type: This is the factory set model name of the Mini-Converter (HA5-Plus).

Assembly: This is the factory assembly number.

Serial Number: This is the factory set unique serial number of your Hi5-Plus. If you ever call AJA Support for service, you may be asked for this number.

Appendix A: Specifications

Video Input

- SDI, 1x BNC
- 3G SMPTE 424/425M
- HD SMPTE 292/296M
- SD SMPTE 259M

Input Formats

(automatic configuration)

- 1 x 3Gb SDI (level A or B)**
- 2048x1080p 23.98, 24, 25, 29.97, 30, 50, 59.94, 60
 - 2048x1080psf 23.98, 24, 25, 29.97, 30
 - 1920x1080p 23.98, 24, 25, 29.97, 30, 50, 59.94, 60
 - 1920x1080psf 23.98, 24, 25, 29.97, 30
 - 1920x1080i 25, 29.97, 30 (4:4:4 and 4:2:2, 12 bit)
 - 1280x720p 50, 59.94, 60 (4:4:4 and 4:2:2, 12 bit)

- 1 x 1.5Gb SDI**
- 2048x1080p 23.98, 24, 25, 29.97, 30
 - 2048x1080psf 23.98, 24, 25, 29.97, 30
 - 1920x1080p 23.98, 24, 25, 29.97, 30
 - 1920x1080psf 23.98, 24, 25, 29.97, 30
 - 1920x1080i 25, 29.97, 30
 - 1280x720p 23.98, 24, 25, 29.97, 30, 50, 59.94, 60

- 1 x 270Mb SDI**
- 525i 29.97
 - 625i 25

NOTE: Interlaced and progressive formats shown with frame rates.

Video Output

- SDI, 1x BNC

Output Formats

Video Out is a delayed, reclocked version of Video In, at same frame rate, etc. Video Out is undefined when no input is present.

- Video Latency** (time measured between video input and video output connector):
- SD (270 Mb) = 17.2 usec
 - HD (1.5 Gb) = 6.3 usec
 - 3G level A = 3.2 usec
 - 3G level B = 6.1 usec

Audio Inputs and Outputs

- AES PCM Audio, 1 x 25 pin D female connector on converter, 8 channels in, 8 channels out, selectable in pairs.
- Breakout cable provided with 1 x 25 pin D male connector:
 - 4 x XLR female input breakout connectors (AES3 110 ohm)
 - 4 x XLR male output breakout connectors (AES3 110 ohm)

- Audio Data Formats**
- AES3-2003
 - SMPTE 337M

- Digital Audio Converters**
- 24 bit

- Embedded Audio**
- SMPTE 272M (SD): 20-bit, 48KHz synchronous
 - SMPTE 299M (3G/HD): 24 bit, 48KHz synchronous
 - Incoming embedded audio can be passed, removed, or overridden.
 - Up to 16 channels supported.

NOTE: 2048x1080p/psf 29.97 and 30 formats support a maximum of 8 channels embedded audio.

- Embed Path Audio Latency** (time measured between audio input and video output connector):
- 1500 usec (SRC ON)
 - 400 usec (SRC OFF)

- Disembed Path Audio Latency** (time measured between video input and audio output connector):
- 210 usec

User Controls

- External DIP switch
- USB port used with MiniConfig software application to configure device via PC/Mac

Physical

Power

- +5 to 20V DC regulated, 5 watts max
- AJA external power supply model DWP-U-R1 (included):
 - 100-240V, 50/60Hz universal input

Size

- 5.8" x 3.1" x 1 (147 x 79 x 25mm)

Environment

Operating Temperature: 0 to 40 degrees C (32 to 104 degrees F)

Operating Relative Humidity: 10-90% non-condensing

Operating Altitude: <2,500 meters (<8,000 feet)

*Safe Storage Temperature
(Power OFF):* -40 to 60 degrees C (-40 to 140 degrees F)

Appendix B: Safety and Compliance

Federal Communications Commission (FCC) Compliance Notices

Class B Interference Statement

This equipment has been tested and found to comply with the limits for a Class B digital device, pursuant to Part 15, Subpart B of the FCC Rules. These limits are designed to provide reasonable protection against harmful interference in a residential installation. This equipment generates, uses, and can radiate radio frequency energy and, if not installed and used in accordance with the instructions, may cause harmful interference to radio communications. However, there is no guarantee that interference will not occur in a particular installation. If this equipment does cause harmful interference to radio or television reception, which can be determined by turning the equipment off and on, the user is encouraged to try to correct the interference by one or more of the following measures:

- Reorient or relocate the receiving antenna.
- Increase the separation between the equipment and receiver.
- Connect the equipment into an outlet on a circuit different from that to which the receiver is connected.
- Consult the dealer or an experienced radio/TV technician for help.

FCC Caution

This device complies with Part 15 of the FCC Rules. Operation is subject to the following two conditions: (1) This device may not cause harmful interference, and (2) this device must accept any interference received, including interference that may cause undesired operation.

Canadian ICES Statement

Canadian Department of Communications Radio Interference Regulations

This digital apparatus does not exceed the Class B limits for radio-noise emissions from a digital apparatus as set out in the Radio Interference Regulations of the Canadian Department of Communications. This Class B digital apparatus complies with Canadian ICES-003.

Règlement sur le brouillage radioélectrique du ministère des Communications

Cet appareil numérique respecte les limites de bruits radioélectriques visant les appareils numériques de classe B prescrites dans le Règlement sur le brouillage radioélectrique du ministère des Communications du Canada. Cet appareil numérique de la Classe B est conforme à la norme NMB-003 du Canada.

European Union and European Free Trade Association (EFTA) Regulatory Compliance

This equipment may be operated in the countries that comprise the member countries of the European Union and the European Free Trade Association. These countries, listed in the following paragraph, are referred to as The European Community throughout this document:

AUSTRIA, BELGIUM, BULGARIA, CYPRUS, CZECH REPUBLIC, DENMARK, ESTONIA, FINLAND, FRANCE, GERMANY, GREECE, HUNGARY, IRELAND, ITALY, LATVIA, LITHUANIA, LUXEMBOURG, MALTA, NETHERLANDS, POLAND, PORTUGAL, ROMANIA, SLOVAKIA, SLOVENIA, SPAIN, SWEDEN, UNITED KINGDOM, ICELAND, LICHTENSTEIN, NORWAY, SWITZERLAND

Declaration of Conformity

Marking by this symbol indicates compliance with the Essential Requirements of the EMC Directive of the European Union 2004/108/EC.



Safety: CB-IEC 60065:2001 +A1:2005 +A2:2010
NRTL-UL 60065:2003 R9.12, CAN/CSA C22.2 No. 60065-03 +A1:06 (R2012) +A2:12
GS-EN 60065:2002 +A1:2006 +A11:2008 +A2:2010 +A12:2011
Additional licenses issued for specific countries available on request.

Emissions: EN 55103-1: 2009
EN 61000-3-2:2006 +A1:2009 +A2:2009, EN 61000-3-3:2008

Immunity: EN 55103-2: 2009
EN 61000-4-2:2009, EN 61000-4-3:2006 +A1:2008 +A2:2010,
EN 61000-4-4:2004 +A1:2010, EN 61000-4-5:2005, EN 61000-4-6:2007
EN 61000-4-8:2010, EN 61000-4-11:2004

The product is also licensed for additional country specific standards as required for the International Marketplace



Warning!

This is a Class B product. In a domestic environment, this product may cause radio interference, in which case, the user may be required to take appropriate measures.

Achtung! Dieses ist ein Gerät der Funkstörgrenzwertklasse B. In Wohnbereichen können bei Betrieb dieses Gerätes Rundfunkstörungen auftreten, in welchen Fällen der Benutzer für entsprechende Gegenmaßnahmen verantwortlich ist.

Attention! Ceci est un produit de Classe B. Dans un environnement domestique, ce produit risque de créer des interférences radioélectriques, il appartiendra alors à l'utilisateur de prendre les mesures spécifiques appropriées.

Korean KCC Compliance Statement

<p>A급 기기 (업무용 방송통신기자재)</p>	<p>이 기기는 업무용(A급) 전자파적합기기로서 판매자 또는 사용자는 이 점을 주의하시기 바라며, 가정외의 지역에서 사용하는 것을 목적으로 합니다.</p>
<p>Class A (Broadcasting Communication Equipment for Office Use)</p>	<p>As an electromagnetic wave equipment for office use (Class A), this equipment is intended to use in other than home area. Sellers or users need to take note of this.</p>

Taiwan Compliance Statement

This is a Class B product based on the standard of the Bureau of Standards, Metrology and Inspection (BSMI) CNS 13438, Class B.

Recycling Notice

	<p>This symbol on the product or its packaging indicates that this product must not be disposed of with your other household waste. Instead, it is your responsibility to dispose of your waste equipment by handing it over to a designated collection point for the recycling of waste electrical and electronic equipment. The separate collection and recycling of your waste equipment at the time of disposal will help conserve natural resources and ensure that it is recycled in a manner that protects human health and the environment. For more information about where you can drop off your waste for recycling, please contact your local authority, or where you purchased your product.</p>
--	---

Translated Warning and Caution Messages

The following caution statements, warning conventions, and warning messages apply to this product and manual.





Warning Symbol



Caution Symbol

Before Operation Please Read These Instructions

	<p>Warning! Read and follow all warning notices and instructions marked on the product or included in the documentation.</p> <p>Avertissement ! Lisez et conformez-vous à tous les avis et instructions d'avertissement indiqués sur le produit ou dans la documentation.</p> <p>Warnung! Lesen und befolgen Sie die Warnhinweise und Anweisungen, die auf dem Produkt angebracht oder in der Dokumentation enthalten sind.</p> <p>¡Advertencia! Lea y siga todas las instrucciones y advertencias marcadas en el producto o incluidas en la documentación.</p> <p>Aviso! Leia e siga todos os avisos e instruções assinalados no produto ou incluídos na documentação.</p> <p>Avviso! Leggere e seguire tutti gli avvisi e le istruzioni presenti sul prodotto o inclusi nella documentazione.</p>
---	---

	<p>Warning! Do not use this device near water and clean only with a dry cloth.</p> <p>Avertissement! N'utilisez pas cet appareil près de l'eau et nettoyez-le seulement avec un tissu sec..</p> <p>Warnung! Das Gerät nicht in der Nähe von Wasser verwenden und nur mit einem trockenen Tuch säubern.</p> <p>¡Advertencia! No utilice este dispositivo cerca del agua y límpielo solamente con un paño seco.</p> <p>Aviso! Não utilize este dispositivo perto da água e limpe-o somente com um pano seco.</p> <p>Avviso! Non utilizzare questo dispositivo vicino all'acqua e pulirlo soltanto con un panno asciutto.</p>
---	--

**Warning!**

Do not block any ventilation openings. Install in accordance with the manufacturer's instructions.

Avertissement ! Ne bloquez aucune ouverture de ventilation. Suivez les instructions du fabricant lors de l'installation.

Warnung! Die Lüftungsöffnungen dürfen nicht blockiert werden. Nur gemäß den Anweisungen des Herstellers installieren.

¡Advertencia! No bloquee ninguna de las aberturas de la ventilación. Instale de acuerdo con las instrucciones del fabricante.

Aviso! Não obstrua nenhuma das aberturas de ventilação. Instale de acordo com as instruções do fabricante.

Avviso! Non ostruire le aperture di ventilazione. Installare in conformità con le istruzioni del fornitore.

**Warning!**

Do not install near any heat sources such as radiators, heat registers, stoves, or other apparatus (including amplifiers) that produce heat.

Avertissement ! N'installez pas l'appareil près d'une source de chaleur telle que des radiateurs, des bouches d'air de chauffage, des fourneaux ou d'autres appareils (amplificateurs compris) qui produisent de la chaleur.

Warnung! Nicht in der Nähe von Wärmequellen wie Heizkörpern, Heizregistern, Öfen oder anderen Wärme erzeugenden Geräten (einschließlich Verstärkern) aufstellen.

¡Advertencia! No instale cerca de fuentes de calor tales como radiadores, registros de calor, estufas u otros aparatos (incluidos amplificadores) que generan calor.

Aviso! Não instale perto de nenhuma fonte de calor tal como radiadores, saídas de calor, fogões ou outros aparelhos (incluindo amplificadores) que produzam calor.

Avviso! Non installare vicino a fonti di calore come termosifoni, diffusori di aria calda, stufe o altri apparecchi (amplificatori compresi) che emettono calore.

**Warning!**

Do not defeat the safety purpose of the polarized or grounding-type plug. A polarized plug has two blades with one wider than the other. A grounding type plug has two blades and a third grounding prong. The wide blade or the third prong are provided for your safety. If the provided plug does not fit into your outlet, consult an electrician for replacement of the obsolete outlet.

Avertissement! La sécurité de la prise polarisée ou de la prise de type mise à la terre ne doit en aucun cas être empêchée de fonctionner. Une prise polarisée a deux broches, l'une étant plus large que l'autre. Une prise de type mise à la terre a deux broches et une troisième broche pour la mise à la terre. La broche large ou la troisième broche sont fournies pour votre sécurité. Si la prise fournie ne s'insère pas dans votre prise femelle, consultez un électricien pour le remplacement de la prise femelle obsolète.

Warnung! Der Sicherheitszweck des gepolten bzw. Schukosteckers ist zu berücksichtigen. Ein gepolter Stecker verfügt über zwei Pole, von denen einer breiter als der andere ist. Ein Schukostecker verfügt neben den zwei Polen noch über einen dritten Pol zur Erdung. Der breite Pol bzw. der Erdungspol dienen der Sicherheit. Wenn der zur Verfügung gestellte Stecker nicht in Ihren Anschluss passt, konsultieren Sie einen Elektriker, um den veralteten Anschluss zu ersetzen.

¡Advertencia! No eche por tierra la finalidad del tipo de enchufe polarizado con conexión a tierra. Un enchufe polarizado tiene dos espigas, una más ancha que la otra. Un enchufe con conexión a tierra tiene dos espigas iguales y una tercera espiga que sirve para la conexión a tierra. La espiga ancha, o la tercera espiga, sirven para su seguridad. Si el enchufe suministrado no encaja en el tomacorriente, consulte con un electricista para reemplazar el tomacorriente obsoleto.

Aviso! Não anule a finalidade da segurança da ficha polarizada ou do tipo ligação terra. Uma ficha polarizada tem duas lâminas sendo uma mais larga do que a outra. Uma ficha do tipo de ligação à terra tem duas lâminas e um terceiro terminal de ligação à terra. A lâmina larga ou o terceiro terminal são fornecidos para sua segurança. Se a ficha fornecida não couber na sua tomada, consulte um electricista para a substituição da tomada obsoleta.

Avviso! Non compromettere la sicurezza della spina polarizzata o con messa a terra. Una spina polarizzata ha due spinotti, di cui uno più largo. Una spina con messa a terra ha due spinotti e un terzo polo per la messa a terra. Lo spinotto largo o il terzo polo sono forniti per motivi di sicurezza. Se la spina fornita non si inserisce nella presa di corrente, contattare un elettricista per la sostituzione della presa obsoleta.

**Warning!**

Since the Mains plug is used as the disconnection for the device, it must remain readily accessible and operable.

Avertissement! Puisque la prise principale est utilisée pour débrancher l'appareil, elle doit rester aisément accessible et fonctionnelle.

Warnung! Da der Netzstecker als Trennvorrichtung dient, muss er stets zugänglich und funktionsfähig sein.

¡Advertencia! Puesto que el enchufe de la red eléctrica se utiliza como dispositivo de desconexión, debe seguir siendo fácilmente accesible y operable.

Aviso! Dado que a ficha principal é utilizada como a desconexão para o dispositivo, esta deve manter-se prontamente acessível e funcional.

Avviso! Poiché il cavo di alimentazione viene usato come dispositivo di sconnessione, deve rimanere prontamente accessibile e operabile.

**Warning!**

Protect the power cord from being walked on or pinched particularly at plugs, convenience receptacles, and the point where they exit from the device.

Avertissement! Protégez le cordon d'alimentation pour que l'on ne marche pas dessus ou qu'on le pince, en particulier au niveau des prises mâles, des réceptacles de convenance, et à l'endroit où il sort de l'appareil.

Warnung! Vermeiden Sie, dass auf das Netzkabel getreten oder das Kabel geknickt wird, insbesondere an den Steckern, den Steckdosen und am Kabelausgang am Gerät.

¡Advertencia! Proteja el cable de energía para que no se le pise ni apriete, en especial cerca del enchufe, los receptáculos de conveniencia y el punto del que salen del equipo.

Aviso! Proteja o cabo de alimentação de ser pisado ou de ser comprimido particularmente nas fichas, em tomadas de parede de conveniência e no ponto de onde sai do dispositivo.

Avviso! Proteggere il cavo di alimentazione in modo che nessuno ci cammini sopra e che non venga schiacciato soprattutto in corrispondenza delle spine e del punto in cui esce dal dispositivo.

**Warning!**

Unplug this device during lightning storms or when unused for long periods of time.

Avertissement! Débranchez cet appareil pendant les orages avec éclairso s'il est inutilisé pendant de longues périodes.

Warnung! Das Gerät ist bei Gewitterstürmen oder wenn es über lange Zeiträume ungenutzt bleibt vom Netz zu trennen.

¡Advertencia! Desenchufe este dispositivo durante tormentas eléctricas o cuando no se lo utilice por largos periodos del tiempo.

Aviso! Desconecte este dispositivo da tomada durante trovoadas ou quando não é utilizado durante longos períodos de tempo.

Avviso! Utilizzare soltanto i collegamenti e gli accessori specificati e/o venduti dal produttore, quali il treppiedi e l'esoscheletro.

**Warning!**

Refer all servicing to qualified service personnel. Servicing is required when the device has been damaged in any way, such as power-supply cord or plug is damaged, liquid has been spilled or objects have fallen into the device, the device has been exposed to rain or moisture, does not operate normally, or has been dropped.

Avertissement ! Référez-vous au personnel de service qualifié pour tout entretien. L'entretien est exigé quand l'appareil a été endommagé de quelque manière que ce soit, par exemple lorsque le cordon d'alimentation ou la prise sont endommagés, que du liquide a été versé ou des objets sont tombés dans l'appareil, que l'appareil a été exposé à la pluie ou à l'humidité, ne fonctionne pas normalement ou est tombé.

Warnung! Das Gerät sollte nur von qualifizierten Fachkräften gewartet werden. Eine Wartung ist fällig, wenn das Gerät in irgendeiner Weise beschädigt wurde, wie bei beschädigtem Netzkabel oder Netzstecker, falls Flüssigkeiten oder Objekte in das Gerät gelangen, das Gerät Regen oder Feuchtigkeit ausgesetzt wurde, nicht ordnungsgemäß funktioniert oder fallen gelassen wurde.

¡Advertencia! Consulte al personal calificado por cuestiones de reparación. El servicio de reparación se requiere cuando el dispositivo ha recibido cualquier tipo de daño, por ejemplo cable o espigas dañadas, se ha derramado líquido o se han caído objetos dentro del dispositivo, el dispositivo ha sido expuesto a la lluvia o humedad, o no funciona de modo normal, o se ha caído.

Aviso! Remeta todos os serviços de manutenção para o pessoal de assistência qualificado. A prestação de serviços de manutenção é exigida quando o dispositivo foi danificado mediante qualquer forma, como um cabo de alimentação ou ficha que se encontra danificado/a, quando foi derramado líquido ou caíram objectos sobre o dispositivo, quando o dispositivo foi exposto à chuva ou à humidade, quando não funciona normalmente ou quando foi deixado cair.

Avviso! Fare riferimento al personale qualificato per tutti gli interventi di assistenza. L'assistenza è necessaria quando il dispositivo è stato danneggiato in qualche modo, ad esempio se il cavo di alimentazione o la spina sono danneggiati, è stato rovesciato del liquido è stato rovesciato o qualche oggetto è caduto nel dispositivo, il dispositivo è stato esposto a pioggia o umidità, non funziona correttamente o è caduto.

**Warning!**

This device is a Class B product. Operation of this equipment in a residential area is likely to cause harmful interference, in which case users will be required to take whatever measures may be necessary to correct the interference at their own expense.

Attention! Le périphérique est un produit de Classe B. Le fonctionnement de cet équipement dans une zone résidentielle risque de causer des interférences nuisibles, auquel cas l'utilisateur devra y remédier à ses propres frais.

Achtung! Dies ist ein Gerät der Klasse B. Bei Einsatz des Geräts in Wohngebieten kann es Störungen des Radio- und Fernsehempfangs verursachen. In diesem Fall muss der Benutzer alle notwendigen Maßnahmen ergreifen, die möglicherweise nötig sind, um die Störungen auf eigene Rechnung zu beheben.

¡Precaución! Este es un producto clase B. El uso de este equipo en áreas residenciales puede causar interferencias nocivas, en cuyo caso, se requerirá que los usuarios tomen cualquier medida necesaria para corregir la interferencia por cuenta propia.

Cuidado! Este dispositivo é um produto Classe B. Operar este equipamento em uma área residencial provavelmente causará interferência prejudicial; neste caso, espera-se que os usuários tomem as medidas necessárias para corrigir a interferência por sua própria conta.

Attenzione! Questo dispositivo è un prodotto di Classe B. Il funzionamento di questo apparecchio in aree residenziali potrebbe causare interferenze dannose, nel cui caso agli utenti verrà richiesto di adottare tutte le misure necessarie per porre rimedio alle interferenze a proprie spese.

**Warning!**

Do not open the chassis. There are no user-serviceable parts inside. Opening the chassis will void the warranty unless performed by an AJA service center or licensed facility.

Avertissement! Ne pas ouvrir le châssis. Aucun élément à l'intérieur du châssis ne peut être réparé par l'utilisateur. La garantie sera annulée si le châssis est ouvert par toute autre personne qu'un technicien d'un centre de service ou d'un établissement agréé AJA.

Warnung! Öffnen Sie das Gehäuse nicht. Keine der Geräteteile können vom Benutzer gewartet werden. Durch das Öffnen des Gehäuses wird die Garantie hinfällig, es sei denn, solche Wartungsarbeiten werden in einem AJA-Service-Center oder einem lizenzierten Betrieb vorgenommen.

¡Advertencia! No abra el chasis. El interior no contiene piezas reparables por el usuario. El abrir el chasis anulará la garantía a menos que se lo haga en un centro de servicio AJA o en un local autorizado.

Advertência! Não abra o chassi. Não há internamente nenhuma peça que permita manutenção pelo usuário. Abrir o chassi anula a garantia, a menos que a abertura seja realizada por uma central de serviços da AJA ou por um local autorizado.

Avvertenza! Non aprire lo chassis. All'interno non ci sono parti riparabili dall'utente. L'apertura dello chassis invaliderà la garanzia se non viene effettuata da un centro ufficiale o autorizzato AJA.

**Warning!**

Disconnect the external AC power supply line cord(s) from the mains power before moving the unit.

Avertissement! Retirez le ou les cordons d'alimentation en CA de la source d'alimentation principale lorsque vous déplacez l'appareil.

Warnung! Trennen Sie die Wechselstrom-Versorgungskabel vom Netzstrom, bevor Sie das Gerät verschieben.

¡Advertencia! Cuando mueva la unidad desenchufe de la red eléctrica el/los cable(s) de la fuente de alimentación CA tipo brick.

Advertência! Remova os cabos CA de alimentação brick da rede elétrica ao mover a unidade.

Avvertenza! Scollegare il cavo dell'alimentatore quando si sposta l'unità.

Warranty Information

Limited Warranty

AJA Video Systems, Inc. (AJA Video) warrants that this product will be free from defects in materials and workmanship for a period of five years from the date of purchase. If a product proves to be defective during this warranty period, AJA Video, at its option, will either repair the defective product without charge for parts and labor, or will provide a replacement in exchange for the defective product.

In order to obtain service under this warranty, you the Customer, must notify AJA Video of the defect before the expiration of the warranty period and make suitable arrangements for the performance of service. The Customer shall be responsible for packaging and shipping the defective product to a designated service center nominated by AJA Video, with shipping charges prepaid. AJA Video shall pay for the return of the product to the Customer if the shipment is to a location within the country in which the AJA Video service center is located. Customer shall be responsible for paying all shipping charges, insurance, duties, taxes, and any other charges for products returned to any other locations.

This warranty shall not apply to any defect, failure or damage caused by improper use or improper or inadequate maintenance and care. AJA Video shall not be obligated to furnish service under this warranty a) to repair damage resulting from attempts by personnel other than AJA Video representatives to install, repair or service the product, b) to repair damage resulting from improper use or connection to incompatible equipment, c) to repair any damage or malfunction caused by the use of non-AJA Video parts or supplies, or d) to service a product that has been modified or integrated with other products when the effect of such a modification or integration increases the time or difficulty of servicing the product.

THIS WARRANTY IS GIVEN BY AJA VIDEO IN LIEU OF ANY OTHER WARRANTIES, EXPRESS OR IMPLIED. AJA VIDEO AND ITS VENDORS DISCLAIM ANY IMPLIED WARRANTIES OF MERCHANTABILITY OR FITNESS FOR A PARTICULAR PURPOSE. AJA VIDEO'S RESPONSIBILITY TO REPAIR OR REPLACE DEFECTIVE PRODUCTS IS THE WHOLE AND EXCLUSIVE REMEDY PROVIDED TO THE CUSTOMER FOR ANY INDIRECT, SPECIAL, INCIDENTAL OR CONSEQUENTIAL DAMAGES IRRESPECTIVE OF WHETHER AJA VIDEO OR THE VENDOR HAS ADVANCE NOTICE OF THE POSSIBILITY OF SUCH DAMAGES.