

Cobalt Digital Inc.

9220 Bidirectional ASI/MPTS Gateway

Product Manual

Version 1.1



9220-UM
Version: 1.1



9220 • Bidirectional ASI/MPTS Gateway Product Manual

- Cobalt Digital Inc. Part Number: **9220-UM**
- Document Version: **1.1**
- Printed in the United States.
- Last Author: CGG
- Printing Date: 10/18/11

The information contained in this manual is subject to change without notice or obligation.

Copyright



© 2011 Cobalt Digital Inc.. All rights reserved.

Contents of this publication may not be reproduced in any form without the written permission of Cobalt Digital Inc.. Reproduction or reverse engineering of copyrighted software is prohibited.

Notice

The material in this manual is furnished for informational use only. It is subject to change without notice and should not be construed as commitment by Cobalt Digital Inc. Cobalt Digital Inc. assumes no responsibility or liability for errors or inaccuracies that may appear in this manual.

Trademarks

-  is a registered trademark of Ross Video Limited.
-  is a registered trademark of Cobalt Digital Inc.
- DashBoard Control System™ is a trademark of Ross Video Limited.

All other product names and any registered and unregistered trademarks mentioned in this manual are used for identification purposes only and remain the exclusive property of their respective owners.

Important Regulatory and Safety Notices

Before using this product and any associated equipment, refer to the “**Important Safety Instructions**” listed below to avoid personnel injury and to prevent product damage.

Products may require specific equipment, and/or installation procedures to be carried out to satisfy certain regulatory compliance requirements. Notices have been included in this publication to call attention to these specific requirements.

Symbol Meanings



This symbol on the equipment refers you to important operating and maintenance (servicing) instructions within the Product Manual Documentation. Failure to heed this information may present a major risk of damage or injury to persons or equipment.



Warning — The symbol with the word “**Warning**” within the equipment manual indicates a potentially hazardous situation which, if not avoided, could result in death or serious injury.



Caution — The symbol with the word “**Caution**” within the equipment manual indicates a potentially hazardous situation which, if not avoided, may result in minor or moderate injury. It may also be used to alert against unsafe practices.



Notice — The symbol with the word “**Notice**” within the equipment manual indicates a situation, which if not avoided, may result in major or minor equipment damage or a situation which could place the equipment in a non-compliant operating state.



ESD Susceptibility — This symbol is used to alert the user that an electrical or electronic device or assembly is susceptible to damage from an ESD event.

Important Safety Instructions



Caution — This product is intended to be a component product of an 8300 series frame. Refer to the frame User Manual for important safety instructions regarding the proper installation and safe operation of the frame as well as its component products.



Warning — Certain parts of this equipment namely the power supply area still present a safety hazard, with the power switch in the OFF position. To avoid electrical shock, disconnect all A/C power cards from the chassis’ rear appliance connectors before servicing this area.



Warning — *Service barriers within this product are intended to protect the operator and service personnel from hazardous voltages. For continued safety, replace all barriers after any servicing.*

This product contains safety critical parts, which if incorrectly replaced may present a risk of fire or electrical shock. Components contained with the product's power supplies and power supply area, are not intended to be customer serviced and should be returned to the factory for repair. To reduce the risk of fire, replacement fuses must be the same time and rating. Only use attachments/accessories specified by the manufacturer.

Maintenance/User Serviceable Parts

Routine maintenance to this Cobalt Digital Inc. product is not required. This product contains no user serviceable parts. If the frame does not appear to be working properly, please contact Technical Support using the numbers listed under the “Contact Us” section on the last page of this manual. All Cobalt Digital Inc. products are covered by a generous 5-year warranty and will be repaired without charge for materials or labor within this period. See the “Warranty and Repair Policy” section in this manual for details.

Environmental Information

The equipment that you purchased required the extraction and use of natural resources for its production. It may contain hazardous substances that could impact health and the environment.

To avoid the potential release of those substances into the environment and to diminish the need for the extraction of natural resources, Cobalt Digital Inc. encourages you to use the appropriate take-back systems. These systems will reuse or recycle most of the materials from your end-of-life equipment in an environmentally friendly and health conscious manner.

The crossed-out wheeled bin symbol invites you to use these systems.

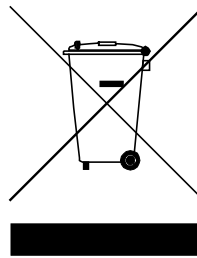

If you need more information on the collection, reuse, and recycling systems, please contact your local or regional waste administration.

You can also contact Cobalt Digital Inc. for more information on the environmental performances of our products.

Contents

Contents	5
Introduction.....	7
Product Overview	7
Redundancy Options.....	8
IP Input Address/Port Redundancy.....	9
Connection Redundancy	9
Indicators and Switches	11
Rear I/O Module Indicators	11
Front Indicators.....	12
Front Switches	13
Operation and Management.....	14
Product Tab.....	15
Network Tab	16
Network Configuration Tab.....	16
Network Statistics Tab.....	17
ASI Ports.....	19
ASI Ports: Configuration Tab.....	19
ASI Ports: Statistics Tab	22
IP Inputs	24
IP Inputs: Configuration Tab	24
Common Parameters.....	25
Redundancy Control	26
Addressing Parameters.....	26
Active IP Inputs Table	28
Determining the Latency Settings.....	30
IP Inputs: Statistics Tab	30
IP Outputs	32
IP Outputs: Configuration Tab.....	32
Active IP Outputs Table.....	35
Managing Unicast MAC Addresses.....	36
IP Outputs: Statistics Tab.....	37
Connections.....	38
Connections Configuration Tab.....	38
Source Selection.....	38
Destination Selection	41
Establishing the Connection	42
The Current Connections Table	43
Connection Statistics Tab	44
Redundancy.....	45
Address/Port Redundancy.....	45
Connection Redundancy	46
Admin	48
Admin General Tab.....	48

Admin Firmware Tab.....	49
Admin Config Files Tab	50
User-Saved Configurations	51
Pre-defined Templates	53
Clear Current Configuration Button	53
Admin Test Packet Generator Tab.....	54
Admin License Keys Tab.....	55
Admin Event Log Tab	56
Warranty and Repair Policy.....	60
Contact Cobalt Digital Inc.	61
Visit us at the Cobalt Digital Inc. website.	61

Introduction

The 9220 is an advanced openGear™ ASI-to-IP and IP-to-ASI gateway, with the following features:

- Up to 6 ASI ports, which can be individually configured as inputs or outputs. Each port supports the full ASI line rate of 213 Mb/s.
- Up to 2 100/1000 Mb/s Ethernet ports, capable of transmitting and receiving at line rate.
- Up to 8 simultaneous transmit and receive streams per Ethernet port.
- Advanced redundancy features.
- Very low latency (under 4 milliseconds for ASI content).
- Advanced IP de-jitter features.
- Internal stream replication – any input to the 9220 can be internally connected to up to 8 outputs.

Typical application scenarios for the 9220 are:

- Contribution and Distribution: interfacing traditional MPEG equipment with IP networks for transport.
- Video Distribution over IP backbones.
- IP to ASI adaptation for devices such as receivers, IRDs, etc.
- IP and ASI protection switching.

Product Overview

The 9220 is essentially a cross-connect switch where transport streams from inputs can be connected to one or more outputs. A given input can be connected to as many as 8 outputs.

The following inputs are available:

- Up to 6 ASI inputs (shared with ASI outputs)
- Up to 8 IP inputs per Ethernet port (for a maximum of 16 IP inputs)
- One internal test packet generator (which can be used to generate ASI or IP test streams)

The following outputs are available:

- Up to 6 ASI outputs (shared with ASI inputs)
- Up to 8 IP outputs per Ethernet port (for a maximum of 16 IP outputs)

In general terms, configuring the 9220 is a two-step process:

Step 1: Configure the input.

Step 2: Configure the output. As part of this step, a connection between the input and the output can be established.

If you are making one-to-many connections, step 1 is performed once, and step 2 is performed multiple times. It is also possible to configure the output first (without making the connection to an input), configure the input next, and finally make the connection between the input and the output.

Note that while it is possible to connect one given input to multiple outputs, only one connection is allowed for a given output.

The overall architecture is depicted below.

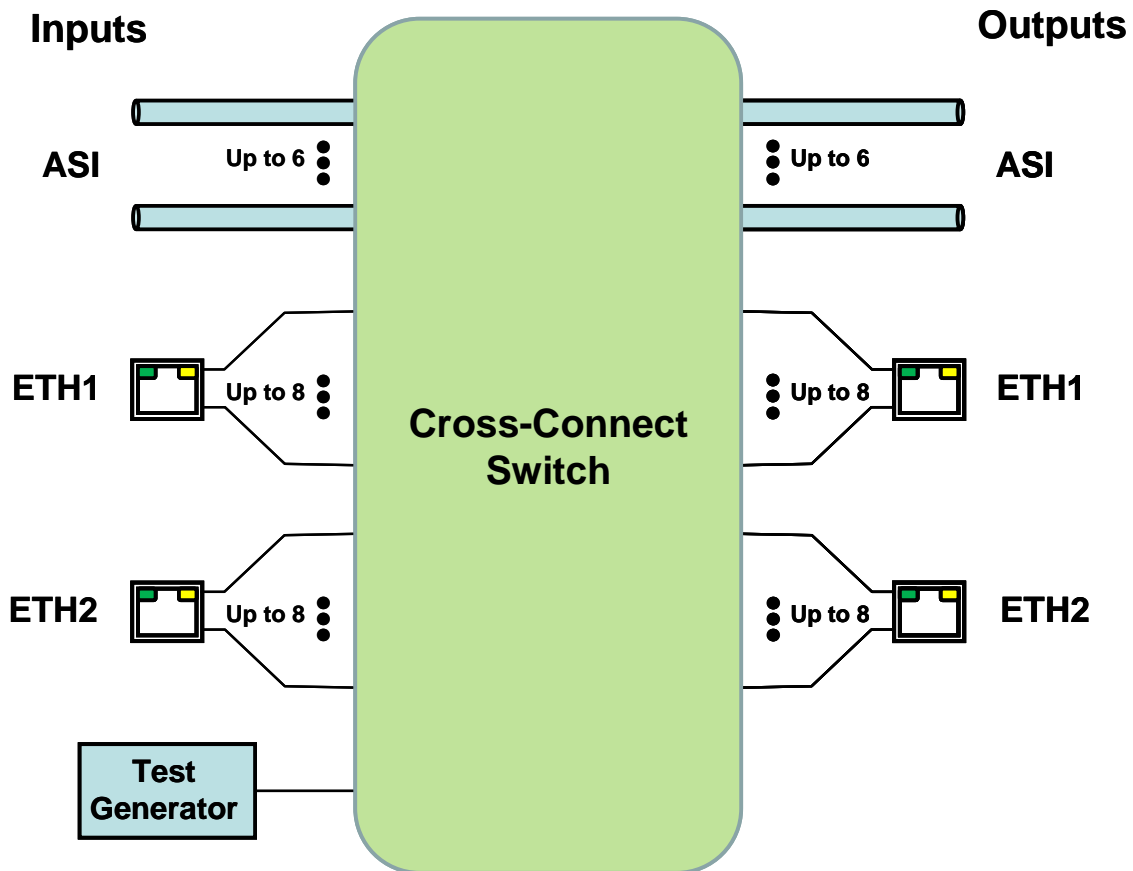

For the remainder of this manual, we will use the term *port* for a physical input/output port (such as ASI or Ethernet), and *stream* for a transport stream present in the port. ASI ports support only one stream, while Ethernet ports support multiple streams.

Redundancy Options

The 9220 can be configured to support transport stream redundancy. This means that the unit can be configured with a “primary transport” and a “backup transport”. If the primary transport disappears, the unit may be set to automatically switch to the backup transport, after a configurable timeout. The following features are common to all redundancy modes:

-
- Transport stream redundancy can be set to “Manual” or “Automatic”. In “Automatic” mode, the unit will switch to the backup stream after a configurable timeout, if the primary stream disappears. In “Manual” mode, the switch has to be performed by the operator.
 - Regardless of the Automatic/Manual mode, the operator always has the ability to instruct the unit to switch to the other transport stream.

The 9220 offers two independent redundancy levels, which can be combined if desired:

- IP Input Address/Port Redundancy
- Connection Redundancy

IP Input Address/Port Redundancy

An IP Input receives a transport stream over UDP/IP, on a given IP Address/UDP Port combination, with an optional Source IP address specification. For each IP Input, the unit allows an optional backup IP Address/UDP Port/Optional Source IP Address combination to be specified. If the transport stream disappears from the primary address/port combination, the port can switch to the backup address/port combination (if configured for automatic redundancy). The automatic switch timeout can be set to a value between 2 and 45 seconds.

This level of redundancy is available for all IP input ports, and is independent of any connections that may exist to the port. It uses no internal resources in the 9220 (i.e., it does not “count” as an input or as a connection), but it has the following limitations:

- It is only available for IP input ports.
- The primary and backup transport streams must be available on the same Ethernet port.
- The 9220 does not monitor the inactive stream. Therefore, if the active stream disappears and the other stream not running either, the 9220 will be switching back and forth until one of the two streams comes back.

The Connection Redundancy level does not have the above limitations, but it does use internal resources in the 9220.

Connection Redundancy

In normal operation, an output port is connected to an input port. The 9220 offers the option of having a backup input port for each connection. If the transport stream coming from the primary input disappears, the connection can switch to the backup input if configured for automatic redundancy. The automatic switch timeout can be set to a value between 2 and 45 seconds.

Connection redundancy does use resources – two input ports must be created and available, and two connections are used (counting against the 8-connection maximum per input). This mode of operation offers the following features:

- Different port types can be used as primary/backup pairs. For example, an ASI input can be configured as the backup for an IP input or vice-versa. Here are some examples of configurations that can exploit this flexibility:

-
- An ASI input can be the backup for an IP Input. For example, the IP input can be the primary feed, and the ASI input a local feed that will be switched in if the primary remote feed disappears.
 - ASI protection switching: two ASI inputs can be configured as primary/backup feeds for an ASI output. If the primary ASI input disappears, the 9220 will connect the ASI output to the backup ASI input.
 - Primary/backup IP streams on separate networks: an IP input in ETH1 can be configured as the primary, and another IP input in ETH2 can be configured as backup.
 - The unit continuously monitors both the primary and the backup transport streams. It will only switch to the backup if it is active. In the situation where both streams are inactive, and one of them starts flowing again, Connection Redundancy will recover faster than Address/Port Redundancy.
 - A given input may be used as a primary or backup input for multiple output ports (up to 8 ports).

Note that the two redundancy levels can be combined. It is possible to have a primary and a backup IP input port for some output port, and each of these two IP inputs may be configured for Address/Port Redundancy.

Indicators and Switches

The 9220 card can be installed in the 10-slot 8310 frame, or in the 20-slot 8321 frame. Prior to installing the card, first install the corresponding rear I/O module. Note that the rear I/O module for the 8321 frame is **different** from the module for the 8310 (8310 frame requires an RM-9220-B rear I/O module; 8321 frame requires an RM20-9220-B rear I/O module).

Rear I/O Module Indicators

The 9220 rear I/O module is depicted below. It includes 6 ASI ports (configurable as inputs or outputs) on standard BNC connectors, and two 100/1000 Mb/s Ethernet ports on standard RJ-45 connectors.

Each of the ASI ports has a green indicator LED, with the following states:

- **LED off:** ASI port is disabled.
- **LED flashing once every 3 seconds:** ASI port is configured as input, but it is not locked to a signal (i.e., there is no input signal).
- **LED flashing once per second:** ASI port is configured as input, and is locked to a signal.
- **LED flashing multiple times per second:** ASI port is configured as output.

Each of the Gigabit Ethernet ports has two indicator LEDs, with the following states:

- **Green LED:**
 - **Off:** No link
 - **On:** Link
- **Yellow LED:**
 - **Off:** No activity (transmit and/or receive)
 - **Flashing:** Port is currently transmitting and/or receiving

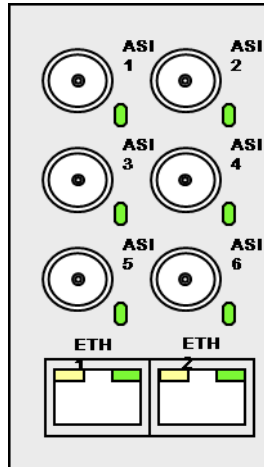

Front Indicators

A similar set of indicators exist in the front of the board. These are visible when the frame front door is opened. The indicator layout is depicted below.

The LED indicators are as follows:

- **Status LED:** indicates the overall status of the board.
 - **Green:** no active alarm
 - **Red:** at least one critical alarm present

When inserting a board in the frame, this LED will be red until the board starts operation. At that point, it will turn green if there is no active alarm or red if there is at least one alarm.
- **Power OK LED:** indicates that the power received from the frame is OK.
 - **Green:** power OK
 - **Off:** no power (or insufficient voltage – check the frame power status)
- **ASI 1 through ASI 6 LEDs:** these behave exactly the same as the corresponding rear I/O module indicators.
- **ETH1 and ETH2 LEDs:** these indicate the status of the corresponding Ethernet connection.
 - **Off:** no link
 - **On:** link OK, no activity
 - **Blinking:** link OK, port is transmitting and/or receiving packets

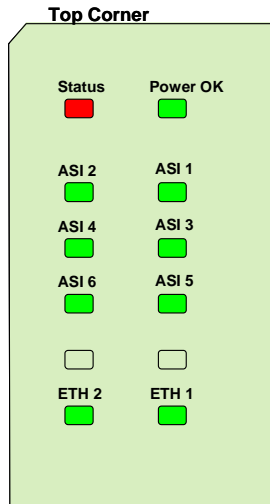

The board has other LEDs that may or may not be illuminated. They are intended for engineering debug only.

Front Switches

The board has two pushbutton-type switches in the front, just below the LEDs, as depicted below. Their operation is as follows:

- **Default IP Switch:** This switch is used to recover the board in the unlikely case of a corrupted or broken firmware update. In most cases, the 9220 will detect the error and automatically fall back into the factory-default firmware load. If it does not, pull the card out, press and hold this switch, and push the card back into the frame while still holding the switch. You can release the switch once the Status LED turns orange. This action causes the card to revert to the factory-default firmware.
- **Reset Switch:** Pressing this pushbutton switch causes the card to reset.

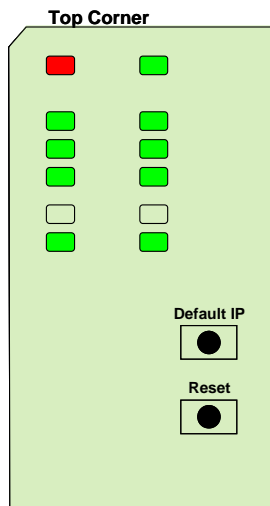

Operation and Management

The 9220 is configured using the free Dashboard™ application, which is available for Windows, Apple OS X, and Linux. Dashboard can be downloaded from this link:

<http://www.opengear.tv/n/?p=94>

As with any openGear™ card, the card display is divided into a statistics panel on the left, and a configuration panel on the right. Each panel has multiple tabs, corresponding to the various functions in the card. Note that the **Card State** alarm indicator is also reflected in the green/red **Status** LED in the front of the board. The Status LED will be green when Card State is green or yellow, and will be red when Card State is red.

The following tabs are available:

- **Product:** this tab provides general information on the card, including firmware version, uptime, temperatures, and other parameters. It appears only on the Statistics panel.
- **Network:** this tab is used to configure the IP addresses and network information for the Ethernet ports. The statistics side of the panel includes some additional information such as link state.
- **ASI Ports:** this tab is used to configure/monitor the ASI ports.
- **IP Inputs:** this tab is used to configure/monitor the IP Input ports. The configuration panel provides the facilities to create, manage and delete ports; the statistics panel includes reception status information.
- **IP Outputs:** this tab is used to configure/monitor the IP Output ports. The configuration panel provides the facilities to create, manage and delete ports; the statistics panel includes transmission status information.
- **Connections:** this tab is used to configure/monitor connections. The configuration panel provides facilities to create, edit and delete connections; the statistics panel provides a table where the status of all the connections in the unit can be inspected at a glance.
- **Redundancy:** this tab is used to manage and monitor the redundancy function. Manual redundancy switches are initiated from the configuration panel.
- **Admin:** this tab is used for general administrative functions, such as firmware upgrades, licensing, logs, and configuration management. The Test Packet Generator configuration is also found under this tab.

Product Tab

The Product Tab contains basic information about the 9220.

The following information is available:

- **Build Date:** Date the firmware image was built.
- **Software revision:** This indicates the firmware revision currently running. The format is Major Version • Minor Version • Build Number.
- **Serial Number:** This is the serial number of this particular 9220 card.
- **Rear Module:** This indicates the status of the Rear I/O Module. It can have one of the following states:
 - **OK:** The Rear Module is the correct module for the 9220.
 - **Not Installed:** The 9220 is not connected to a rear module. The card is operating normally, but it will not be useful as there are no input and output connections to it.
 - **Wrong Module:** The 9220 is connected to a rear module that was not designed for it (most likely from another openGear™ vendor). Depending on the signals present on that module, there may be a small chance of damage to the 9220; Cobalt Digital Inc. recommends that this situation be rectified immediately. This alarm will cause the front status LED to turn red.
- **Card Uptime:** Indicates how long the card has been running since it was last rebooted.
- **Ambient Temperature:** Temperature, in degrees centigrade, of the air intake of the card (measured at the front edge of the card).
- **Internal Temperature:** Temperature, in degrees centigrade, at the back of the card.
- **MDP Core Temperature:** Temperature, in degrees centigrade, of the core MediaStorm processing element.

The openGear™ frame is designed to operate in environments with up to 40°C ambient. There is typically a 5°C temperature raise from the external ambient to the “Ambient Temperature” measured by the 9220. If that measurement is at 45°C or higher, action must be taken to cool down the ambient temperature.

Network Tab

The Network Tab allows for configuration/monitoring of the two Ethernet ports.

Network Configuration Tab

The Network Configuration Tab is used to set the individual parameters for each of the Ethernet ports.

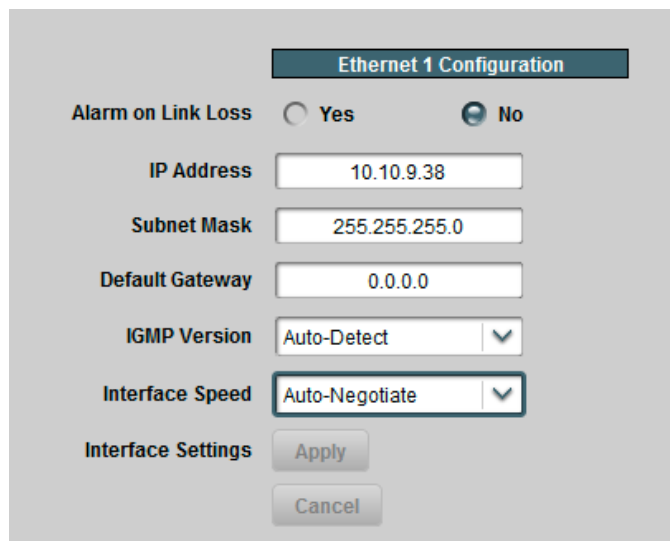

The following parameters can be configured:

- **Alarm on Link Loss:** If set to Yes, the card will raise an alarm if this Ethernet interface loses link. The Card State indicator in Dashboard™ and the front Status LED will both be red. If set to No, the card will still report loss of link in the Statistics page but no alarm will be raised. It is recommended to turn on the alarm for ports that are in use; only turn it off if you do not plan to connect that port to a network.
- **IP Address:** Enter the desired IP address for this Ethernet port.
- **Subnet Mask:** Enter the desired subnet mask for this Ethernet port.
- **Default Gateway:** Enter the desired default gateway for this Ethernet port, or 0.0.0.0 if no gateway is available.
- **Interface Settings:** If you make any changes to the IP Address, Subnet Mask and/or Default Gateway fields, the **Apply** and **Cancel** buttons become active. The changes only take effect when you press the **Apply** button. Pressing the **Cancel** button reverts the fields back to their original values. Note that the 9220 will check the consistency of the data entered and will reject invalid combinations. Once the **Apply** button is pressed, a status message appears just below the **Cancel** button, as follows:

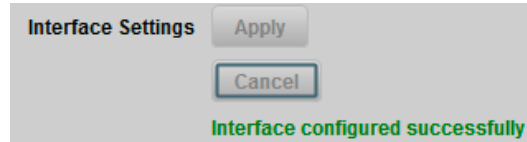

- **IGMP Version:** The 9220 implements the IGMP protocol for multicast reception. This parameter controls the version of the protocol to be used.
 - **Auto-Detect:** The 9220 will attempt to auto-detect the IGMP version in use by inspecting the Group Membership Requests received from the router. It defaults to IGMP Version 3 if no messages are received.
 - **IGMP Version 1:** Force the use of Version 1 only (not recommended)
 - **IGMP Version 2:** Force the use of Version 2 only
 - **IGMP Version 3:** Force the use of Version 3 only
- **Interface speed:** Configures the speed of the interface. The 9220 Ethernet interfaces only support two modes: 100 Mb/s Full-Duplex and 1 Gb/s Full-Duplex¹.
 - **Auto-Negotiate:** The Ethernet port will auto-negotiate the speed.
 - **100 Mb/s Full-Duplex:** Force the port to 100Mb/s Full-Duplex mode. Note that the port will still perform auto-negotiation, but it will only advertise this mode.
 - **1Gb/s Full-Duplex:** restrict the operation to 1Gb/s Full-Duplex mode. Note that the port will still perform auto-negotiation, but it will only advertise this mode.

Network Statistics Tab

The Network Statistics Tab reports the current IP configuration of each Ethernet port, as well as their link state and running status.

¹ Support for 10 Mb/s and Half-Duplex modes has been disabled, as these are unsuitable for MPEG transport over IP applications. Moreover, any modern switch supports at least 100 Mb/s Full-Duplex.

Ethernet 1 Configuration	
Alarm on Link Loss	Yes
IP Address	10.10.9.30
Subnet Mask	255.255.255.0
Default Gateway	0.0.0.0
IGMP Version	Auto-Detect
Interface Speed	Auto-Negotiate
Port 1 Link	● Link OK
Port 1 Status	● OK
Link Speed (Mb/s)	1000
MAC Address	02:30:1d:11:22:32

The following parameters are reported in the Network Statistics tab:

- **Alarm on Link Loss:** Reports the current setting of this parameter.
- **IP Address:** Reports the current IP Address for the port.
- **Subnet Mask:** Reports the current Subnet Mask for the port.
- **Default Gateway:** Reports the current Default Gateway for the port.
- **IGMP Version:** Reports the current setting for this parameter.
- **Interface Speed:** Reports the current setting for this parameter.
- **Port 1/2 Link:** This indicator has the following states:
 - ● **Link OK:** The port has established link with the switch.
 - ● **No Link:** The port does not currently have link. If Alarm on Link Loss is set to Yes, the Dashboard™ Card State will be red and the Status LED in the front of the board will also be red. If Alarm on Link Loss is set to No, this indicator will still be red, but the alarm will not propagate.
- **Port 1/2 Status:** This indicator is the port overrun status. It has the following states:
 - ● **OK:** The port is operating normally.
 - ● **TX Overflow:** In the current configuration, the IP outputs are attempting to transmit more than the port capacity (i.e., the overall output data for this port exceeds the interface speed of 100 Mb/s or 1 Gb/s). The Dashboard™ Card State will be red and the Status LED in the front of the board will also be red. In this case, reduce the output bit rate (either by externally controlling the inputs or by removing output ports). **If this indicator is red, data is being dropped.**
- **Link Speed (Mb/s):** This parameter reports the actual speed negotiated with the switch for the port. If the port has no link, the value reported here is zero.
- **MAC Address:** This reports the MAC address of the Ethernet port.

ASI Ports

The 9220 card has 6 ASI ports that can be individually configured as inputs or outputs. Unused ASI ports can be disabled. This tab is used to configure and manage the ASI Ports.

ASI Ports: Configuration Tab

If the 9220 has not yet been configured, all the ASI ports are disabled. The appearance of the Configuration Tab is:

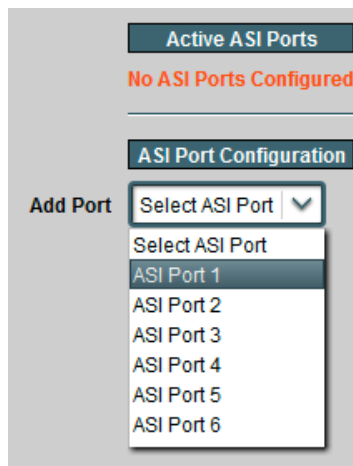

From the **Add Port** drop down list, select the port you wish to configure. The port configuration defaults to **Receive** (ASI Input):

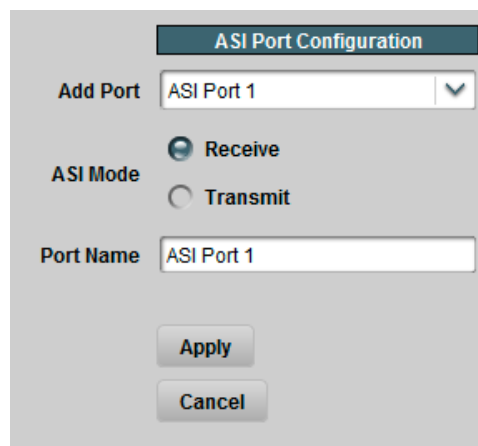

All 9220 inputs and outputs can be assigned a user-defined **Port Name**. This name is used to identify the port later when making connections. Use any descriptive name suitable for your application, or accept the default.

If you are setting up an ASI input, there are no more parameters to configure. If you are configuring an ASI output, select **Transmit** on the **ASI Mode** parameter; the ASI output parameters become available, as depicted below:

The screenshot shows the 'ASI Port Configuration' dialog box. It has a title bar 'ASI Port Configuration'. Below it, there are several configuration options:

- Add Port:** A dropdown menu showing 'ASI Port 1'.
- ASI Mode:** Two radio buttons: 'Receive' (unselected) and 'Transmit' (selected).
- Port Name:** A text field containing 'ASI Port 1'.
- Packet Size:** Two radio buttons: '188' (unselected) and '204' (selected).
- ASI Rate:** Two radio buttons: 'Manual' (selected) and 'Automatic' (unselected).
- Bit Rate:** A text field containing '40000000'.
- Primary Source:** A section with two dropdown menus: 'Source Port' (set to 'ASI Input') and 'Source Stream' (set to 'Select ASI Input').
- Backup Connection:** Three radio buttons: 'Disabled' (selected), 'Automatic' (unselected), and 'Manual' (unselected).
- At the bottom, there are 'Apply' and 'Cancel' buttons.

Two red boxes highlight specific sections of the dialog:

- The first red box, labeled 'ASI Output Parameters', encloses the 'Packet Size', 'ASI Rate', and 'Bit Rate' fields.
- The second red box, labeled 'Connection Parameters', encloses the 'Primary Source' and 'Backup Connection' sections.

The above configuration screen can be divided into two parts:

- ASI Output Parameters
- Connection Parameters

The Connection Parameters are common to all outputs, and are described in the Connections section, later in this document. The ASI Output Parameters are:

- **Packet Size:** Select between 188 and 204 bytes.
- **ASI Rate:** The following two modes are available:
 - **Manual:** In this mode, the ASI output bit rate is set to the value entered in the **Bit Rate** field. The ASI output will maintain this rate at all times, as follows:
 - If there is no connection to the ASI port, or if the input connected to the ASI port is not active, the ASI port will transmit NULL packets.
 - If the connected input bit rate is lower than the rate entered in the **Bit Rate** field, the ASI port will add NULL packets as required to pad it to the desired value. PCR packets will be re-stamped as required.

- If the connected input bit rate is higher than the rate entered in the **Bit Rate** field, the ASI port will attempt to remove NULL packets from the input in order to achieve the desired value. PCR packets will be re-stamped as required. If there are not enough NULL packets to be deleted, packets will be dropped, and an alarm will be raised. This alarm will be indicated in the Dashboard™ **Card State** field, in the front Status LED, and in the ASI Statistics page.
 - **Automatic:** If this mode is selected, the **Bit Rate** field disappears. The ASI output will exactly match the rate of the connected input. However, if the connected input has no data, or if the ASI port is not connected to any input, there will be no output, and any connected downstream ASI device will indicate loss of sync. The ASI Statistics page will indicate this state. Note that an alarm will only be raised if there is an input connected to the ASI output.
- **Bit Rate:** This field is only available if the **ASI Rate** mode is set to **Manual**. Enter the desired ASI output bit rate here, in bits/second. The minimum value is 64,000 and the maximum value is 213,000,000.

Once the port is configured, click on the **Apply** button, and the configuration takes effect. If there are any errors, they will be reported in the area on top of the **Apply** button. Two types of errors can be reported:

1. Errors related to the port configuration itself. The only error of this kind applies to ASI outputs; the 9220 requires individual output transport stream licenses, and if none are available, the port configuration will fail. Contact Cobalt Digital Inc. to obtain additional licenses.
2. Errors related to the connection, if you are configuring one. These are described in the Connections section.

As ports are configured, they become visible in the **Active ASI Ports** table. An example is depicted below:

Active ASI Ports							
	Mode	Status	Size	TS Bit Rate (b/s)	Port Name	Edit	Port
ASI Port 1	Transmit	OK	188	40,000,000	ASI Port 1	Edit	Delete
ASI Port 2	Receive	Unlocked	0	0	ASI Port 2	Edit	Delete
ASI Port 3	Transmit	Unlocked	204	0	ASI Port 3	Edit	Delete
ASI Port 5	Receive	Locked	188	40,000,499	ASI Port 5	Edit	Delete
ASI Port 6	Transmit	Overflow	204	4,000,000	ASI Port 6	Edit	Delete

The columns of the table are as follows:

- **Mode:** Indicates the port mode (Transmit or Receive).
- **Status:** Indicates the port status. It can contain the following values:

- **OK:** Port is operating normally. This status is issued for Transmit (Output) ports only.
- **Unlocked:** Port is unlocked. If it is a Receive (Input) port, it means that it cannot lock to the signal. If it is a Transmit (Output) port, it means that the port is in Automatic mode and it has no input.
- **Locked:** Receive (Input) port is locked to a signal.
- **Overflow:** Transmit (Output) port overflow. This means that the ASI Output is in Manual mode, and the configured bit rate is insufficient to carry the input connected to it. This situation will raise an alarm.
- **Size:** Indicates the transport packet size, in bytes. For ASI Outputs, this is the configured size. ASI Inputs auto-detect the packet size and report it here. If the port is not locked to a signal, it will report zero here (see ASI Port 2 in the figure above).
- **TS Bit Rate (b/s):** This reports the transport stream bit rate, in bits/second. For ASI Outputs, this is the actual rate in the ASI port. For ASI Inputs, this is the bit rate after conversion to 188-byte packets. For ASI Outputs in Manual mode, the rate reported here is the configured rate; for ASI Inputs and ASI Outputs in Automatic mode, this is the measured bit rate over 2-second windows, and may fluctuate by ± 750 b/s.
- **Port Name:** This reports the configured Port Name.
- **Edit Button:** Clicking on this button allows reconfiguration of the port. The ASI Port Configuration screen re-appears, with the settings for the selected port.
- **Delete Button:** Clicking on this button deletes the port. The ASI port is disabled, and the entry in the table is removed. Any connections to or from the port are removed.

ASI Ports: Statistics Tab

The Statistics Tab for the ASI Ports provides a quick visual summary status for the ports. A sample, corresponding to the table example of the previous section, is depicted below.

ASI Port Summary	
ASI Port 1	● TX OK
ASI Port 2	● RX Unlocked
ASI Port 3	● TX Unlocked
ASI Port 4	<input type="radio"/> Disabled
ASI Port 5	● RX Locked
ASI Port 6	● TX Overflow

Each of the ASI Port indicators can have the following values:

- **TX OK:** The port is operating normally in transmit mode (ASI Output).
- **RX Locked:** The port is operating normally in receive mode (ASI Input); it is locked to an input signal.

-
- **○ Disabled:** The port is disabled. There will be no entry in the Active ASI Ports table for it.
 - **● TX Overflow:** The port is in transmit mode, manual bit rate setting, and the connected bit rate is excessive. The Dashboard™ Card State will be red and the Status LED in the front of the board will also be red. To correct this problem, either externally reduce the input bit rate, or increase the ASI output bit rate, or configure the port in Automatic mode. **If this alarm is active, data is being dropped.**
 - **● TX Unlocked:** The port is in transmit mode, automatic bit rate, and there is no data rate coming to it. Any downstream ASI receivers will lose lock. Dashboard™ Card State and the Status LED will be red if there is a connection to this port.
 - **● RX Unlocked:** The port is in receive mode, and it is not locked to any signal. Dashboard™ Card State and the Status LED will be red if there is a connection to this port.

IP Inputs

IP Inputs receive transport streams over UDP/IP from the Ethernet ports, de-jitter them, and make them available for connections to outputs. The 9220 card supports up to 8 transport stream inputs per Ethernet port. IP Inputs have the following specifications:

- Format support: MPEG-2 Transport Packets over UDP/IP.
- Maximum data rate per stream: 120 Mb/s.
- Number of MPEG-2 Transport Packets per UDP datagram: between 1 and 7 (no support for IP fragmentation).
- Addressing support: unicast, multicast and broadcast.
- Configurable source IP address filtering.
- Configurable IP Address/UDP Port redundancy.

IP Inputs: Configuration Tab

The IP Input Configuration follows a similar workflow as the ASI Ports. Ports can be created, configured, and deleted. Before any ports are created, the Configuration Tab appears as depicted below:

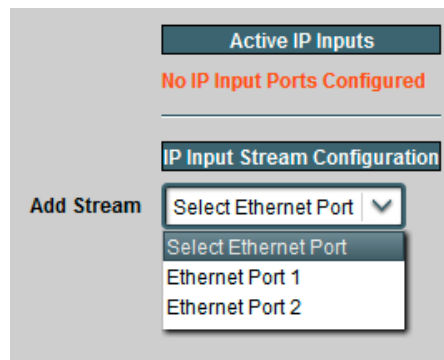

To create an IP Input stream, first select the desired Ethernet port in the **Add Stream** drop-down box. Once that selection is made, the IP Input Stream Configuration is displayed, as depicted below. The configuration screen has three areas:

- **Common Parameters:** apply to the stream input as a whole, regardless of the redundancy options.
- **Redundancy Control:** allows selection of the redundancy mode.
- **Addressing Parameters:** allow selection of the network stream to be received

Common Parameters

- **Enabled:** This allows the stream to be enabled or disabled. If it is disabled, no packet reception takes place. This feature is provided for testing purposes (i.e., temporarily disable an input for fault-finding). Most users will leave the stream enabled.
- **Stream Name:** All 9220 inputs and outputs can be assigned a user-defined name. This name is used to identify the port later when making connections. Use any descriptive name suitable for your application, or accept the default.
- **Latency (ms):** This is the de-jitter latency, in milliseconds. This setting corresponds to the buffering latency introduced by the 9220 to remove IP jitter. At 120 Mb/s, the maximum latency supported is 100 ms; at lower rates, the maximum will be proportionally increased (for example, at 20 Mb/s, the maximum is 600 ms). Entering a value of 0 (zero) disables the de-jitter function². Once the port is created and in operation, the 9220 will measure the actual jitter. Therefore, if the input jitter is unknown (which is the most common case), set this parameter to 100 ms, run the unit for a representative period of time, read the measured jitter, and then reduce it. This process is described in detail later in the “Determining the Latency Settings” section.

² Note that an IP stream with a de-jitter setting of zero must not be connected to an ASI output as it will cause overflows.

Redundancy Control

As described in the Redundancy Options section, the IP Inputs offer option of defining a primary and a backup address/port combination. This is enabled in by the **Backup** parameter, which offers the following options:

- **Disabled:** no redundancy.
- **Automatic:** a redundant address/port can be defined, and the input will automatically switch between primary and backup if the stream disappears. If this option is selected, a new field is displayed, where the Switch Time can be configured; valid values are between 2 and 45 seconds:

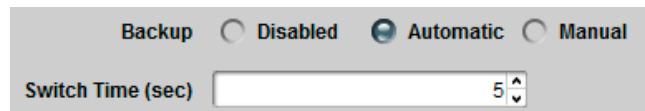

The screenshot shows a control panel for redundancy. At the top, there are four radio button options: 'Backup', 'Disabled', 'Automatic', and 'Manual'. The 'Automatic' option is selected. Below these options is a text input field labeled 'Switch Time (sec)' with the value '5' entered and a small up/down arrow icon to its right.

- **Manual:** a redundant address/port can be defined, but the input will **not** automatically switch – that will have to be done manually by the operator. Redundancy switches are performed in the Redundancy Tab, described later in the Redundancy section.

Addressing Parameters

The Addressing parameters allow the definition of one or two address/port combinations for reception. If **Backup** is set to **Disabled**, only the primary settings are displayed; otherwise, both the primary and backup settings are displayed, as shown below.

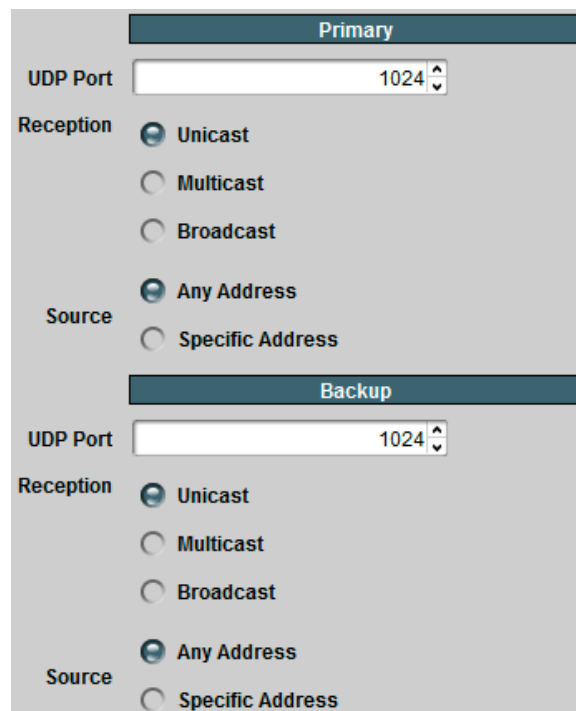

The screenshot displays two sections for configuring addressing parameters. The top section is titled 'Primary' and contains a 'UDP Port' field set to 1024, a 'Reception' section with 'Unicast' selected, and a 'Source' section with 'Any Address' selected. The bottom section is titled 'Backup' and contains identical settings: 'UDP Port' set to 1024, 'Reception' set to 'Unicast', and 'Source' set to 'Any Address'.

The Primary/Backup addressing parameters are configured as follows:

- **UDP Port:** selects the UDP port to receive from. Valid values are between 1 and 65535. Note that, in traditional IP networks, UDP ports between 1 and 1023 are reserved for administrative uses. It is recommended to use UDP ports 1024 and higher. The 9220, however, will accept any legal value.
- **Reception:** selects the address to receive from. The options are:
 - **Unicast:** the packets are being sent to the IP address of this Ethernet port. The address of the Ethernet port can be set or reviewed in the Network Tab.
 - **Multicast:** the packets are being sent to a Class-D multicast address (between 224.0.0.0 and 239.255.255.255). If this option is selected, a new field is displayed to accept the multicast address:

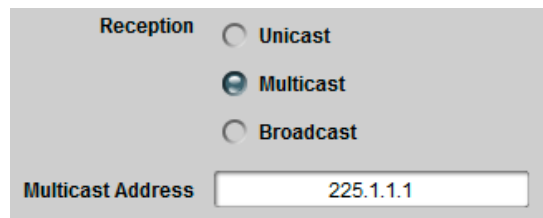

The 9220 will warn the user if the address entered in this field is not a multicast address. The device includes a full implementation of IGMP V1/V2/V3 to convey group membership information to upstream routers; IGMP is configured in the Network Tab.

- **Broadcast:** the packets are being sent to a broadcast address (either the all-hosts broadcast address of 255.255.255.255 or a subnet broadcast address). Note that this is extremely rare in practice.
- **Source:** If desired, the 9220 can filter packets by source IP address. This is useful when the network includes a primary and a backup stream, sent to the same address, but from different sources. The options are:
 - **Any Address:** this input will accept packets from any address.
 - **Specific Address:** this input will only accept packets from a given specific address. When this option is selected, a new field appears where the desired source IP address can be entered:

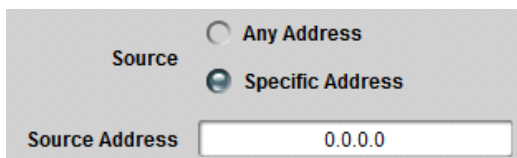

Unicast/Broadcast

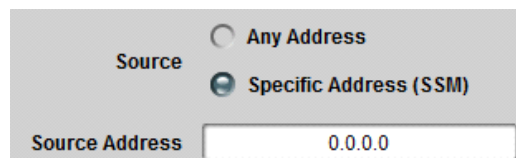

Multicast

The **Source Address** must be a valid unicast address. In case of Multicast reception, the 9220 will go into SSM (Source-Specific Multicast) mode. If IGMP V3 is in use, the card will use it to inform the network of the choice selection. Note that the 9220 does **not** require an IGMP V3 network to operate in SSM mode, as it can filter packets in real-time at line rate.

Once the configuration information is filled in, click on the **Apply** button to make it active. If there are no errors, the port will be created, and the configuration area disappears. If any errors are detected, they will be displayed at the top of the **Apply** button. The following errors are flagged:

- **Error: enter a Source Address or select "Any Address"**: you selected **Specific Address** for **Source** but left the **Source Address** field as 0.0.0.0.
- **Error: X.X.X.X is NOT a multicast address**: you selected multicast reception, and entered an address that is not multicast. Multicast addresses go from 224.0.0.0 to 239.255.255.255.
- **Error: X.X.X.X is NOT a valid unicast address**: you entered an invalid unicast address. Valid unicast addresses go from 0.0.0.1 to 223.255.255.255, with the exception of the loopback range of 127.0.0.0 to 127.255.255.255.
- **Error: Primary and Backup settings are the same**: you entered the exact same configuration settings for the primary and backup address/port. They must have at least one difference.
- **Error: Primary/Backup UDP Port/Address conflict with Port X/Y Primary/Backup**: you are attempting to configure an address/port combination that is already in use by another input in the same Ethernet port. The 9220 is capable of internally replicating transport streams; just use the other port again in the connection. There is, however, one special case: if you want to configure an input with a given address/port combination and any source, and another input with the same address/port combination and a specific source, you must configure the input with specific source first.
- **Error: Ethernet Port 2 not licensed**: operation of the second Ethernet port requires a license; please contact Cobalt Digital Inc.
- **Maximum number of streams exceeded on this port**: you will receive this message if you attempt to create more than 8 IP inputs on a given Ethernet port.

Active IP Inputs Table

Once the input is created, it is added to the **Active IP Inputs** table, which has **Basic** and **Advanced** views. This table provides a summary of the configuration and status of the input stream. An example of this table, in the Basic view, is depicted below

View		<input checked="" type="radio"/> Basic		<input type="radio"/> Advanced		Active IP Inputs								
		Enabled	Locked	TS	UDP	Reception	Stream	Edit	Delete					
				Bit Rate(b/s)	Port	Address	Name	Port	Port					
Port 1/1		Yes	Yes	100,001,155	1024	225.1.1.1	NBC Feed	Edit	Delete					
Port 1/2		Yes	No	0	1025	10.10.9.10	ABC Feed	Edit	Delete					
Port 1/3		Yes	No	0	1026	Broadcast	HBO West	Edit	Delete					

The Basic view includes the following:

- **Enabled:** The configured value of this parameter.
- **Locked:** This column will have **Yes** for inputs that are receiving a valid transport stream, and **No** for inputs that are not.
- **TS Bit Rate (b/s):** This column provides the measured bit rate of the input transport stream. This does not include UDP and IP overhead.
- **UDP Port:** The active reception UDP port (i.e., the UDP port currently being used by the input).
- **Reception Address:** The active reception address (i.e., the address being currently used by the input). If you selected **Unicast**, this field will contain the IP address of the corresponding Ethernet interface. If you selected **Multicast**, this field will contain the configured multicast address. If you selected **Broadcast**, this field will contain the word “Broadcast”.
- **Stream Name:** The configured stream name.
- **Edit Port:** If you click on this button, you can modify all the parameters for this input. The configuration area will re-open with the current input settings.
- **Delete Port:** If you click on this button, the port is deleted and removed from the table.

When the Advanced view is selected, additional fields appear in the table, as depicted below:

Active IP Inputs													
Enabled	Locked	Backup	TS	IP Packet	Latency	Max Jitter	UDP	Reception	Source	Stream	Edit	Delete	
		Mode	Bit Rate(b/s)	Rate(pkt/s)	(ms)	(ms)	Port	Address	Address	Name	Port	Port	
Port 1/1	Yes	Yes	Automatic	100,001,362	9,498	100	0	1024	225.1.1.1	Any	NBC Feed	Edit	Delete
Port 1/2	Yes	No	Disabled	0	0	40	0	1025	10.10.9.10	192.168.5.5	ABC Feed	Edit	Delete
Port 1/3	Yes	No	Disabled	0	0	40	0	1026	Broadcast	Any	HBO West	Edit	Delete

The Advanced view includes all items in the Basic view plus the following:

- **Backup Mode:** The configured value of this parameter.
- **IP Packet Rate (pkts/s):** The measured IP input packet rate, in packets/second. This field is useful for debugging: if you have a non-zero IP Packet Rate, but a zero TS Bit Rate, this indicates that the packets being received by the 9220 do not contain a valid transport stream. This allows differentiation between a transport network problem (no packets being received) and a data format problem (packets contain invalid data).
- **Latency (ms):** The configured value of this parameter.
- **Max Jitter (ms):** The maximum jitter measured by the 9220 for this input stream. This is reported as zero if there is no reception.
- **Source Address:** The active source address (i.e., the address currently being used by the input). This will have the word “Any” if the Source was configured as **Any Source**, or the configured IP address.

Additionally, when you select the **Advanced** view, a button to reset the Max Jitter measurement becomes available. When pressed, it resets the measurement for all configured input streams.

Determining the Latency Settings

The data in the **Advanced** view is useful in determining the best **Latency** setting for the input stream. The procedure is as follows:

1. Configure the desired input streams, using a high value for the latency setting – 100 milliseconds is a good starting point.
2. Make sure that your streams are operating as desired, and that your network is properly set up.
3. Click on the “Reset Max Jitter Measurement” button in the **Advanced** view.
4. Let the system run for a period of time – a good choice would be 24 to 48 hours.
5. For each input, check the Max Jitter measurement in the **Advanced** view. For proper operation, the Latency setting must be higher than the Max Jitter. We recommend adding a 30% margin.
6. Reconfigure the latency value on each port to the optimum value. Note that changing the latency setting causes a short stream interruption.

IP Inputs: Statistics Tab

The Statistics tab for the IP input ports contains a summary of each port status. There are two sub-tabs: one for Ethernet 1, and another for Ethernet 2. The tab is depicted below:

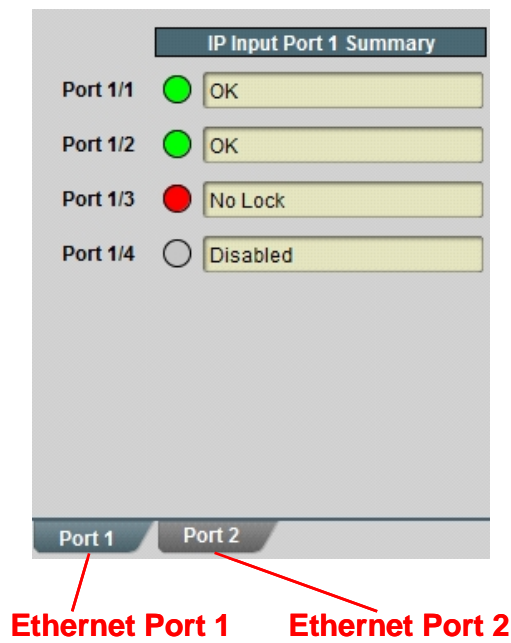

The indicators can have the following values:

- **● OK:** The IP Input is receiving a valid transport stream.
- **● No Lock:** The IP Input is not receiving a valid transport stream. If there is a connection to this input, Dashboard™ Card State and the Status LED will be red.
- **○ Disabled:** The IP Input has been disabled (by setting **Enable** to **No**).

IP Outputs

IP Outputs receive data from connected inputs, format this data for transmission over UDP/IP, and send it with very precise timing over the Ethernet ports. The 9220 card supports up to 8 transport stream outputs per Ethernet port. IP Outputs have the following specifications:

- Format support: MPEG-2 Transport Packets over UDP/IP.
- Number of MPEG-2 Transport Packets per UDP datagram: fixed at 7.
- Addressing support: unicast, multicast and broadcast.
- Advanced control over the IP header fields available.

IP Outputs: Configuration Tab

The IP Output Configuration follows a similar workflow as the IP Inputs. Ports can be created, configured, and deleted. Before any ports are created, the Configuration Tab appears as depicted below:

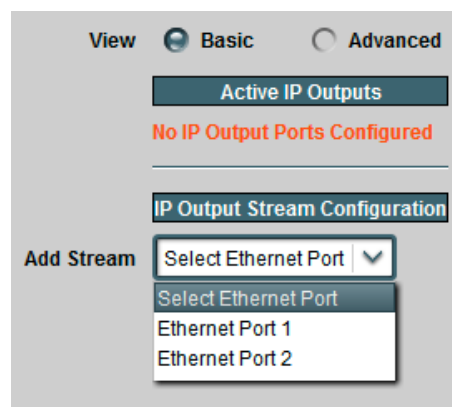

To create an IP Output stream, first select the desired Ethernet port in the **Add Stream** drop-down box. Once that selection is made, the IP Output Stream Configuration is displayed, as depicted below (Basic View). The configuration screen has two areas:

- **IP Output Parameters:** these are the parameters specific to the IP Output configuration. The set of parameters available for configuration depends on the **View** selection. In the **Basic** view, suitable default values are entered for the advanced parameters.
- **Connection Parameters:** these allow a standalone or redundant connection to be made to the output port.

The Connection Parameters are common to all output ports, and will be described in the Connections section, later in this document.

The screenshot shows the 'IP Output Stream Configuration' dialog box. It is divided into two main sections highlighted with red boxes. The top section, labeled 'IP Output Parameters', includes the 'Add Stream' dropdown (set to 'Ethernet Port 1'), the 'Enabled' radio buttons (with 'Yes' selected), the 'UDP Port' spinner (set to 1024), the 'Destination Address' text field (set to 225.1.1.1), and the 'Stream Name' text field (set to 'Port 1 Stream 1'). The bottom section, labeled 'Connection Parameters', includes the 'Primary Source' section with 'Source Port' (set to 'ASI Input') and 'Source Stream' (set to 'Select ASI Input') dropdowns, and the 'Backup Connection' radio buttons (with 'Disabled' selected). At the bottom of the dialog are 'Apply' and 'Cancel' buttons.

The Basic View configuration parameters are as follows:

- **Enabled:** This allows the output stream to be enabled or disabled. If it is disabled, no packet transmission takes place. This feature is provided for testing purposes (i.e., temporarily disable an output for fault-finding). Most users will leave the stream enabled.
- **UDP Port:** selects the UDP port to transmit to. Valid values are between 1 and 65535. Note that, in traditional IP networks, UDP ports between 1 and 1023 are reserved for administrative uses. It is recommended to use UDP ports 1024 and higher. The 9220, however, will accept any legal value.
- **Destination Address:** selects the IP address to transmit to. Any unicast or multicast address can be entered here, with the exception of the loopback range (127.0.0.0 to 127.255.255.255). The 9220 will also accept the broadcast IP address of 255.255.255.255, and will transmit the packets as Ethernet broadcasts. Use of broadcasts, however, is strongly discouraged.
- **Stream Name:** All 9220 input and output ports can be assigned a user-defined name. This name is used to identify the port later when making connections. Use any descriptive name suitable for your application, or accept the default.

If the Advanced View is selected, four more parameters are available for configuration:

View Basic **Advanced**

IP Output Stream Configuration

Add Stream

Enabled Yes No

UDP Port

Destination Address

Stream Name

TOS

TTL

DF Bit Set Not Set

RTP

Advanced Parameters

- **TOS:** This parameter allows the configuration of the Type-Of-Service (TOS) byte in the IP header (also known as the Differentiated Services – DS – field). Valid values are between 0 and 255. Configuring this is only useful if the downstream router is configured to honor the field.
- **TTL:** This parameter allows the configuration of the Time-To-Live (TTL) byte in the IP header. Valid values are between 0 and 255. If not explicitly configured, it defaults to 128. This field controls how many hops the packet can traverse before it is dropped by a router. The default value of 128 is suitable for virtually all applications.
- **DF Bit:** This parameter allows the configuration of the Do-not-Fragment (DF) bit in the IP header. The 9220 will never produce fragmented packets, and with the UDP payload set to 7 transport packets, the IP packets are guaranteed to fit inside the Ethernet MTU. This control is provided for compatibility with legacy switches/routers. Some legacy equipment may exhibit performance problems if this bit is not set. This is not an issue with current network equipment.
- **RTP:** If this box is checked, the 9220 will include RTP (Real Time Protocol) headers in the output flow. If it is not checked, the transport stream will be sent over UDP/IP without any additional headers. Note that RTP requires the use of even UDP port numbers.

Once the configuration information is filled in, click on the **Apply** button to make it active. If there are no errors, the port will be created, and the configuration area disappears. If any errors are detected, they will be displayed at the top of the **Apply** button. Two types of errors can be reported:

1. Errors related to the port configuration itself. These are listed below.
2. Errors related to the connection, if you are configuring one. These will be described in the Connections section.

The following configuration-related errors are flagged:

- **Error: UDP Port/Address conflict with Port X/Y:** you have configured two IP Output streams with the same destination IP Address and UDP port, on the same Ethernet interface. Please review your settings.
- **Error: No Output License Available:** output transport streams are individually licensed in the 9220. Contact Cobalt Digital Inc. to obtain additional licenses.
- **Error: Ethernet Port 2 not licensed:** operation of the second Ethernet port requires a license; please contact Cobalt Digital Inc.
- **Maximum number of streams exceeded on this port:** you will receive this message if you attempt to create more than 8 IP inputs on a given Ethernet port.
- **Error: UDP Port must be even if RTP is enabled:** if you check the RTP box in the **Advanced** view, the UDP port number must be even. Either select an even number or uncheck the RTP box.

If the configuration is successful, the output stream will be added to the Active IP Outputs table.

Active IP Outputs Table

Once the output is created, it is added to the **Active IP Outputs** table, which has **Basic** and **Advanced** views. This table provides a summary of the configuration and status of the output stream. An example of this table, in the Basic view, is depicted below

View		Basic		Advanced		Active IP Outputs		
Enabled	TS	UDP	Destination	Stream	Edit	Delete		
	Bit Rate(b/s)	Port	Address	Name	Port	Port		
Port 1/1	Yes	100,000,566	5555	225.5.5.5	Modulator Connection	Edit	Delete	
Port 1/2	Yes	0	1025	192.168.1.2	Studio Link	Edit	Delete	
Port 1/3	Yes	0	1026	10.10.9.1	Decoder Monitor	Edit	Delete	
Port 2/1	Yes	20,000,000	7777	227.7.7.7	Port 2 Stream 1	Edit	Delete	

The Basic view includes the following:

- **Enabled:** The configured value of this parameter.
- **TS Bit Rate (b/s):** This column provides the current bit rate of the output transport stream. This does not include UDP and IP overhead.
- **UDP Port:** The configured value of this parameter.
- **Destination Address:** The configured value of this parameter.

- **Stream Name:** The configured stream name.
- **Edit Port:** If you click on this button, you can modify all the parameters for this output. The configuration area will re-open with the current output settings.
- **Delete Port:** If you click on this button, the port is deleted and removed from the table.

When the Advanced view is selected, additional fields appear in the table, as depicted below:

Active IP Outputs												
Enabled	TS	UDP	Destination	TOS	TTL	DF	RTP	Destination	Stream	Edit	Delete	
	Bit Rate(b/s)	Port	Address					MAC	Name	Port	Port	
Port 1/1	Yes	8,001,301	5555	225.5.5.5	0	128	Set	No	01005e050505	Modulator Connection	Edit	Delete
Port 1/2	Yes	0	1025	192.168.1.2	0	128	Set	No	Unknown	Studio Link	Edit	Delete
Port 1/3	Yes	0	1026	10.10.9.1	0	128	Set	No	0014d11aa6bd	Decoder Monitor	Edit	Delete
Port 2/1	Yes	20,000,000	7777	227.7.7.7	0	128	Set	No	01005e070707	Port 2 Stream 1	Edit	Delete

The Advanced view includes all items in the Basic view plus the following:

- **TOS:** The configured value of this parameter.
- **TTL:** The configured value of this parameter.
- **DF:** The configured value of this parameter.
- **RTP:** The configured value of this parameter
- **Destination MAC:** The destination MAC address for this IP Output. For multicast destination addresses, this is derived from the destination IP address using the rules from RFC 1112. For unicast destination addresses, this is obtained using the ARP protocol. If this entry is the word **Unknown**, the 9220 has failed to obtain a destination MAC address. The port is **not** streaming. A more detailed description of the unicast MAC address algorithms used in the 9220 is presented below.

Managing Unicast MAC Addresses

When the 9220 is configured with a unicast destination address, it needs to obtain a corresponding MAC address (corresponding to either the final destination, if it is in the same subnet, or to the default gateway). These MAC addresses are obtained using the ARP protocol. The 9220 uses a custom MAC address management algorithm, designed specifically for MPEG operation.

When an IP Output port with a unicast destination address is created, the 9220 immediately starts attempting to obtain a MAC address for it, using standard ARP requests. These requests are issued every two seconds until answered. No packets will be transmitted on that IP Output until a MAC address can be obtained. Note that this process will happen even if the port is configured to be in the disabled state.

Once a MAC address is obtained, the 9220 will cache it for about 5 minutes, as it is usual for IP devices. Unlike other IP devices, the 9220 will keep on using the MAC address until a response is received, to avoid stream interruptions. If no response is received at that time, the 9220 will raise a yellow alarm. This alarm can be seen in the IP Output Statistics tab, described in detail below.

The current state of the 9220 current streaming ARP cache is available in the Advanced View of the Active IP Outputs table, described above.

IP Outputs: Statistics Tab

The Statistics tab for the IP output ports contains a summary of each port status. There are two sub-tabs: one for Ethernet 1, and another for Ethernet 2. The tab is depicted below:

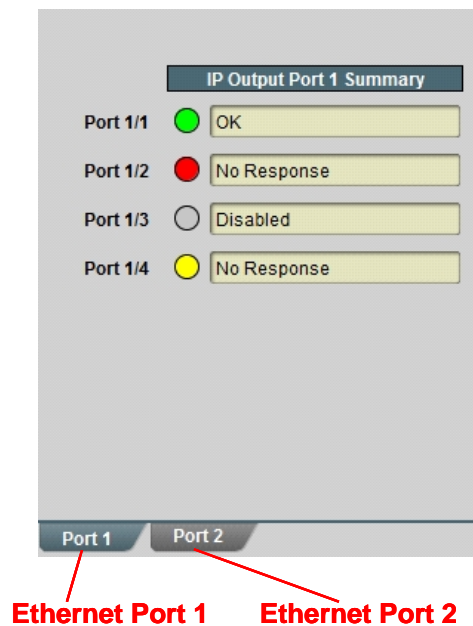

The indicators can have the following values:

- **OK:** The IP Output is operating normally (either streaming or ready to stream).
- **No Response:** The IP Output is configured for unicast operation, but it does not have a destination MAC address. If there is a connection to this output, Dashboard™ Card State and the Status LED will be red.
- **No Response:** The IP Output is configured for unicast operation, and the destination stopped responding to ARP. The IP Output is using an old cached MAC address. If there is a connection to this output, the Dashboard™ Card State will be yellow (but packets are being transmitted).
- **Disabled:** The IP Output has been disabled (by setting **Enable** to **No**).

Connections

The Connections allows the creation, deletion, and management of input-output connections. The Statistics tab includes all connected input/output status indicators and an overall summary status indicator, which allows the operator to immediately pinpoint errors.

Connections Configuration Tab

The Connections configuration tab is depicted below. The message “Connection Table Empty” will be displayed if there are no configured input/output connections in the 9220. As indicated in the figure, the Connections configuration area is divided into two parts: a source port selection, and a destination port selection.

The screenshot displays the 'Connections Configuration Tab' interface. At the top, a red message reads 'Connection Table Empty'. Below this, there are radio buttons for 'Stream Display', 'Stream Names' (selected), and 'Stream Addresses'. A dark blue button labeled 'Add/Edit Connections' is centered. The configuration is divided into two main sections, each enclosed in a red box. The first section, labeled 'Primary Source' on the left, contains a 'Source Port' dropdown menu set to 'ASI Input', a 'Source Stream' dropdown menu set to 'Select ASI Input', and 'Backup Connection' radio buttons for 'Disabled' (selected), 'Automatic', and 'Manual'. The second section, labeled 'Destination Port' on the left, contains a 'Destination Port' dropdown menu set to 'ASI Output' and a 'Destination Stream' dropdown menu set to 'Select ASI Output'. At the bottom of the form are 'Apply' and 'Cancel' buttons. Red text labels 'Source Selection' and 'Destination Selection' are placed to the right of their respective sections.

To establish a connection, simply select a source (and optionally a backup source), a destination, and then click on Apply.

Source Selection

The Source Selection area is available in the Connections tab, as well as in the ASI Ports and IP Outputs tabs. This allows the operator to establish a connection to a given output as that output is being configured. The operation is the same regardless of the location of the control.

The Source Port Selection is a two-step process:

- **Step 1:** Select the port type in the **Source Port** drop-down list. The options are:
 - **IP Input 1:** UDP/IP Input streams from Ethernet Port 1.
 - **IP Input 2:** UDP/IP Input streams from Ethernet Port 2.
 - **ASI Input:** ASI ports configured as inputs
 - **TPG:** Test Packet Generator (internal test stream).

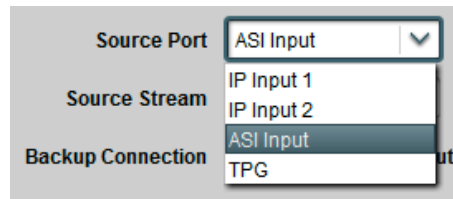

- **Step 2:** Select the individual stream in the **Source Stream** drop-down list. The names presented here are the Stream Names configured when the ports were created. If no streams were configured in that port, no options will be presented. This process is illustrated below.

Default Names:

Active IP Inputs							
Enabled	Locked	TS	UDP	Reception	Stream	Edit	Delete
		Bit Rate(b/s)	Port	Address	Name	Port	Port
Yes	Yes	100,001,053	1024	225.1.1.1	Port 1 Stream 1	Edit	Delete
Yes	Yes	100,001,053	1025	225.1.1.2	Port 1 Stream 2	Edit	Delete
Yes	No	0	1026	225.1.1.3	Port 1 Stream 3	Edit	Delete

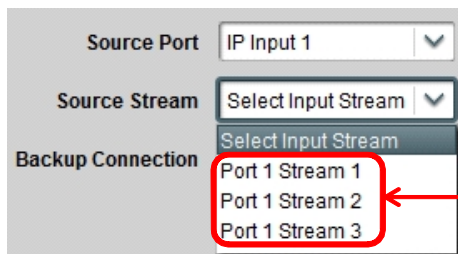

Customized Names:

Active IP Inputs							
Enabled	Locked	TS	UDP	Reception	Stream	Edit	Delete
		Bit Rate(b/s)	Port	Address	Name	Port	Port
Yes	Yes	100,000,418	1024	225.1.1.1	NBC Feed	Edit	Delete
Yes	Yes	100,000,418	1025	225.1.1.2	ABC Feed	Edit	Delete
Yes	No	0	1026	225.1.1.3	HBO West	Edit	Delete

Source Port: IP Input 1

Source Stream: Select Input Stream

Backup Connection: NBC Feed, ABC Feed, HBO West

In some situations, it may be desirable to identify the IP streams by their address/port combinations rather than using a name. This mode can be enabled by selecting **Stream Addresses** in the **Stream Display** control, as depicted below. This operation does not affect the user-defined names.

Active IP Inputs							
Enabled	Locked	TS	UDP	Reception	Stream	Edit	Delete
		Bit Rate(b/s)	Port	Address	Name	Port	Port
Yes	Yes	100,000,418	1024	225.1.1.1	NBC Feed	Edit	Delete
Yes	Yes	100,000,418	1025	225.1.1.2	ABC Feed	Edit	Delete
Yes	No	0	1026	225.1.1.3	HBO West	Edit	Delete

Stream Display: Stream Names Stream Addresses

Source Port: IP Input 1

Source Stream: Select Input Stream

Backup Connection: 225.1.1.1:1024, 225.1.1.2:1025, 225.1.1.3:1026

If a backup connection is desired, it can be selected at this point as well. The same two options are available: **Automatic** redundancy, where the 9220 will switch by itself after a configurable timeout, and **Manual** redundancy, where the operator is responsible for switching. If **Automatic** redundancy is selected, a field to configure the switch time becomes available. Valid values are from 2 to 45 seconds. This is illustrated below.

The top screenshot shows the 'Backup Connection' section with three radio buttons: 'Disabled', 'Automatic' (selected), and 'Manual'. Below it is a 'Switch Time (sec)' field with a value of 5 and up/down arrows. The bottom screenshot shows the same section but with 'Manual' selected and 'Automatic' unselected.

If you select **Automatic** or **Manual** for the **Backup Connection**, a second set of Source Port/Source Stream drop-down menus are displayed, to select the backup source. These operate in exactly the same fashion as the primary source selections. The complete interface is shown below.

The interface is divided into two main sections: 'Primary Source' and 'Backup Source'. In the 'Primary Source' section, 'Source Port' is 'IP Input 1' and 'Source Stream' is 'Select Input Stream'. In the 'Backup Source' section, 'Source Port' is 'ASI Input' and 'Source Stream' is 'Select ASI Input'. Between these sections, the 'Backup Connection' radio buttons are shown, with 'Automatic' selected and 'Switch Time (sec)' set to 5. Red boxes and labels highlight the source selection fields.

Destination Selection

The Destination Selection operates in the same fashion as the Source Selection. It is again a two-step process, where a port is selected, and then a stream on that port is selected. Note that only one connection can be made to any given output; therefore, the 9220 will only offer unconnected outputs in the Destination Selection. If you wish to modify an existing route, either delete and recreate it, or edit it. This process is explained later in this section.

The Destination Port Selection is depicted below. The options are as follows:

- **IP Output 1:** UDP/IP Output streams transmitted on Ethernet Port 1.
- **IP Output 2:** UDP/IP Output streams transmitted on Ethernet Port 2.
- **ASI Output:** ASI ports configured as outputs

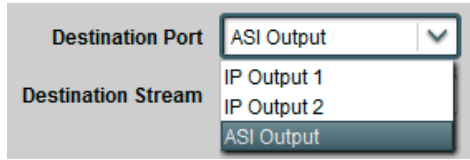

Once the port is selected, the **Destination Stream** drop down menu is populated with the available output streams on that port. Only streams that are unconnected and enabled are presented:

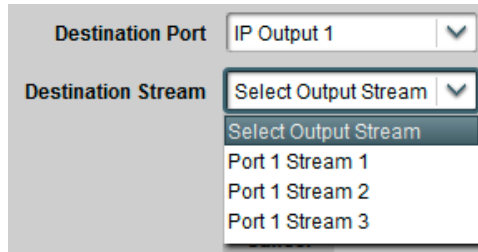

In the same fashion as with the Source Selection, the names can be customized, and the selection can be presented as addresses rather than names. Both situations are illustrated below.

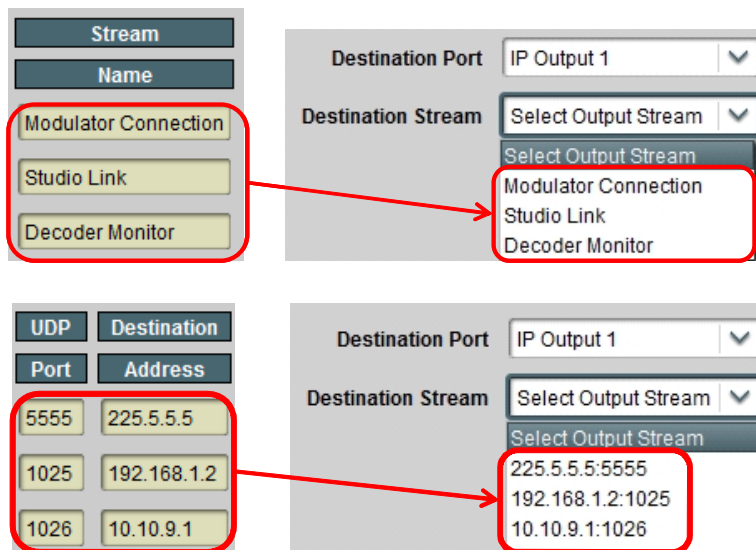

Establishing the Connection

Once the connection is configured, click on **Apply** to establish it. If no errors are detected, the connection is established and added to the **Current Connections** Table. If the connection fails, an error message will appear next to the **Apply** button. The following errors are detected:

- **Error: Missing primary source selection:** you have not selected a primary source for the connection.
- **Error: Missing destination selection:** you have not selected a destination for the connection.

- **Error: Missing backup source selection:** you have selected **Automatic** or **Manual** redundancy, but you did not select a backup source. Either select **Disabled** on **Backup Connection** or select a backup source.
- **Error: Primary and backup selections are the same:** you have selected **Automatic** or **Manual** redundancy, and you selected the same source for both primary and backup. Either select **Disabled** on **Backup Connection** or select different source for either primary or backup.
- **Error: Maximum number of connections exceeded for primary/backup:** the 9220 can support only a maximum of 8 connections to any given input. This was exceeded for either the primary or backup.

The Current Connections Table

As connections are established (either in the Connections tab, or as part of the output port configuration), they are added to the Current Connections table. Regardless of how they got added, the connections can be edited or deleted using the functions in this table. A sample of this table is depicted below.

The following columns are available in this table:

- **Source Port, Source Stream:** these columns have the current source for the connection. If there is a redundancy switch, these fields will change accordingly. The Source Stream column will change to indicate address/port if **Stream Display** is set to **Stream Addresses**.
- **Backup Mode:** this column contains the configured value for this parameter.
- **Destination Port, Destination Stream:** this column contains the destination for the connection. The Destination Stream column will change to indicate address/port if **Stream Display** is set to **Stream Addresses**.
- **Edit:** if you click on this button, you can edit the connection. The selection area below the table will be populated with the connection parameters.
- **Delete:** if you click on this button, the corresponding connection will be deleted.
- **Select/Delete Selected Connections:** if you need to delete multiple connections, mark them in the **Select** column, and then click the **Delete Selected Connections** button.

Current Connections							
Source Port	Source Stream	Backup Mode	Destination Port	Destination Stream	Connection	Select	Connection
IP Input 1	NBC Feed	Disabled	ASI Output	Galaxy5 Uplink 1	Edit	<input type="checkbox"/>	Delete
IP Input 1	ABC Feed	Automatic	ASI Output	Galaxy5 Uplink 2	Edit	<input type="checkbox"/>	Delete
IP Input 1	HBO West	Manual	ASI Output	Decoder Monitor	Edit	<input type="checkbox"/>	Delete

Delete Selected Connections

Connection Statistics Tab

The Connection Statistics Tab presents the combined status of all the established connections, in one table. It includes the Source Port, Source Stream, Destination Port and Destination Stream fields to identify the connections, and the rows are in the same order as the table in the Configuration Tab. The Statistics tab contains two additional fields, the **Source Status** and the **Destination Status**. Since these are color-coded, it is simple to quickly identify any problems. The Statistics Tab also includes an overall **Connection Status** indicator, which contains the highest priority alarm in the table. If the **Connection Status** indicator is red, the Dashboard™ Card State will be red as well, and the Status LED in the front of the card will also be red. If the **Connection Status** indicator is yellow, the Dashboard™ Card Status may also be yellow (unless there is a higher priority alarm elsewhere).

The meaning of the indicators is as follows:

- **OK:** The stream is operating normally. If it is an input, it means that a transport stream is being received by it; if it is an output, it means that it is either transmitting or ready to transmit.
- **Warning:** The stream is configured but disabled. Simply enabling the stream may clear this situation.
- **Error:** The stream is configured but has detected a problem. If it is an input, this normally means that no data is being received (e.g., an IP input is not seeing any packets, an ASI input is not locked). If this is an output, it normally means that the output is either unable to send (e.g., an IP output configured for unicast but unable to find the destination MAC address) or dropping packets (e.g., an oversubscribed ASI output). ASI Outputs with Automatic Rate will be in this state if they do not have data to transmit.

A sample of the Connection Statistics Tab is depicted below.

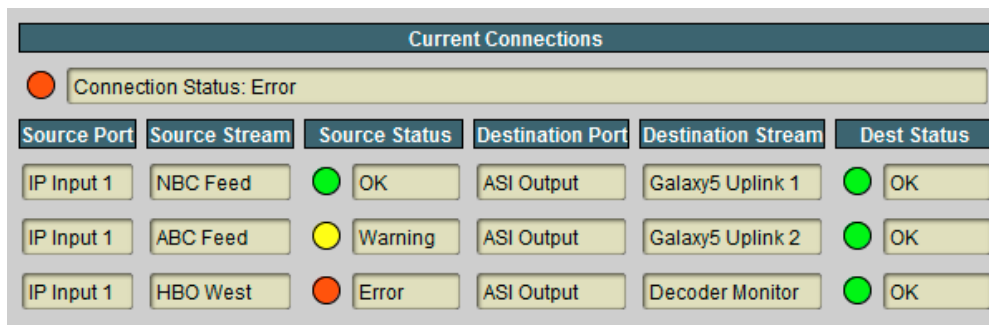

The screenshot shows a window titled "Current Connections". At the top, there is a "Connection Status: Error" indicator with a red circle. Below this is a table with the following columns: Source Port, Source Stream, Source Status, Destination Port, Destination Stream, and Dest Status. The table contains three rows of data.

Source Port	Source Stream	Source Status	Destination Port	Destination Stream	Dest Status
IP Input 1	NBC Feed	OK	ASI Output	Galaxy5 Uplink 1	OK
IP Input 1	ABC Feed	Warning	ASI Output	Galaxy5 Uplink 2	OK
IP Input 1	HBO West	Error	ASI Output	Decoder Monitor	OK

Redundancy

The Redundancy Tab provides a unified view of all configured primary/backup pairs, for both Address/Port Redundancy and Connection Redundancy. The following features are available on this tab:

- Display of all primary/backup parameters.
- For each primary/backup pair, indication of which setting is online (active).
- Ability to manually switch the redundancy.

The Configuration and Statistics Redundancy Tabs are depicted below. Note that Address/Port Redundancy and Connection Redundancy have their own individual tabs, both in the Statistics and in the Configuration areas.



As redundant address/port and connection pairs are configured, they automatically appear in the tabs above.

Address/Port Redundancy

A populated Address/Port Redundancy table is depicted below. The only difference between the Configuration and Statistics area is that the former includes a **Switch** button; otherwise they are the same.

Configuration Tab

	Primary	Primary	Primary	Primary	Backup	Backup	Backup	Backup	Switch	Manual
	Port	Address	Source	State	Port	Address	Source	State	Time (sec)	Redundancy
Port 1/1	1024	225.1.1.1	Any	<input checked="" type="radio"/> A	2024	225.10.1.1	Any	<input type="radio"/> X	5	<input type="button" value="Switch"/>
Port 1/2	1025	225.1.1.2	10.10.9.36	<input checked="" type="radio"/> A	1025	225.1.1.2	192.168.1.1	<input type="radio"/> X	0	<input type="button" value="Switch"/>

Statistics Tab

	Primary	Primary	Primary	Primary	Backup	Backup	Backup	Backup	Switch
	Port	Address	Source	State	Port	Address	Source	State	Time (sec)
Port 1/1	1024	225.1.1.1	Any	<input checked="" type="radio"/> A	2024	225.10.1.1	Any	<input type="radio"/> X	5
Port 1/2	1025	225.1.1.2	10.10.9.36	<input checked="" type="radio"/> A	1025	225.1.1.2	192.168.1.1	<input type="radio"/> X	0

The fields in the table are:

- **Primary/Backup Port:** Configured UDP port for primary/backup.
- **Primary/Backup Address:** Configured reception IP address for primary/backup.
- **Primary/Backup Source:** Configured source IP address for primary/backup. If the setting is to receive from any source, this field will contain the word **Any**.
- **Primary/Backup State:** This indicates which setting is online (active) and which setting is offline. The indicator has the following possible values:
 - A : This indicates that the setting is online (active).
 - X : This indicates that the setting is offline (inactive).
- **Switch Time (sec):** This indicates the automatic redundancy switch time, in seconds. If manual redundancy is configured, the value displayed here is 0 (zero). In the example above, Port 1/1 is in automatic redundancy with a switch time of 5 seconds, while Port 1/2 is in manual redundancy.
- **Manual Redundancy Switch:** This control is in the configuration tab only. If you click on this button, a manual redundancy switch is initiated. The button is available for both manual and automatic redundancy modes. Note that, if the port is in automatic redundancy mode, and you manually switch it to a stream that is not running, it will switch back to the running stream after the configured switch time.

Connection Redundancy

A populated Address/Port Redundancy table is depicted below. The only difference between the Configuration and Statistics area is that the former includes a **Switch** button; otherwise they are the same.

Configuration Tab

Primary	Primary	Primary	Backup	Backup	Backup	Destination	Destination	Switch	Manual
Source Port	Source Stream	State	Source Port	Source Stream	State	Port	Stream	Time (sec)	Redundancy
IP Input 1	Contribution Feed	<input checked="" type="radio"/> A	IP Input 1	Backup Contribution Feed	<input type="radio"/> X	IP Output 2	QAM Output	0	Switch
ASI Input	Local Encoder	<input type="radio"/> X	IP Input 1	NBC Feed	<input checked="" type="radio"/> A	ASI Output	Modulator Output	5	Switch

Statistics Tab

Primary	Primary	Primary	Backup	Backup	Backup	Destination	Destination	Switch
Source Port	Source Stream	State	Source Port	Source Stream	State	Port	Stream	Time (sec)
IP Input 1	Contribution Feed	<input checked="" type="radio"/> A	IP Input 1	Backup Contribution Feed	<input type="radio"/> X	IP Output 2	QAM Output	0
ASI Input	Local Encoder	<input type="radio"/> X	IP Input 1	NBC Feed	<input checked="" type="radio"/> A	ASI Output	Modulator Output	5

The fields in the table are:

- Primary/Backup Source Port/Source Stream:** These fields contain the configured port/stream for the primary and backup connection sources.
- Primary/Backup State:** This indicates which setting is online (active) and which setting is offline. The indicator has the following possible values:
 - A : This indicates that the setting is online (active).
 - X : This indicates that the setting is offline (inactive).
- Switch Time (sec):** This indicates the automatic redundancy switch time, in seconds. If manual redundancy is configured, the value displayed here is 0 (zero). In the example above, Port 1/1 is in automatic redundancy with a switch time of 5 seconds, while Port 1/2 is in manual redundancy.
- Manual Redundancy Switch:** This control is in the configuration tab only. If you click on this button, a manual redundancy switch is initiated. The button is available for both manual and automatic redundancy modes. Note that, if the port is in automatic redundancy mode, and you manually switch it to a stream that is not running, it will switch back to the running stream after the configured switch time.

Admin

The Admin tab contains a number of general administrative functions, each on its own tab. The general layout is shown below:

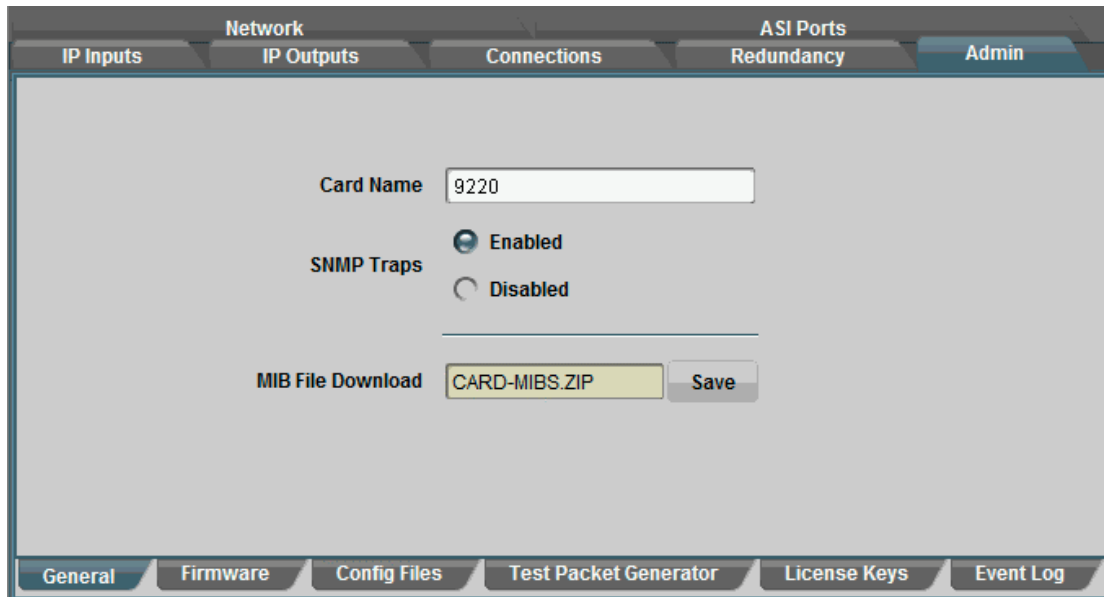

The Admin tabs are:

- **General:** Manages a number of general card parameters; provides an SNMP MIB download.
- **Firmware:** Manages firmware images.
- **Config Files:** The 9220 has the ability to store multiple configurations, and it has a number of pre-set configurations as well. These are managed in this tab.
- **Test Packet Generator:** Manages the Test Packet Generator.
- **License Keys:** Contains the current licensing state of the 9220, and allows for new license keys to be entered.
- **Event Log:** The 9220 contains a non-volatile event log. It can be inspected and downloaded from this tab.

The Admin Statistics tabs are simplified read-only versions of the corresponding Admin Configuration tabs. They will not be explicitly described here.

Admin General Tab

The Admin General Tab includes the following parameters:

-
- **Card Name:** This field defaults to “9220” but can be set to any descriptive name. The name provided here will also appear in the Dashboard™ Tree View.
 - **SNMP Traps:** This allows SNMP traps to be enabled or disabled³. Note that this setting does not take effect immediately – it will become active the next time the card is rebooted.
 - **MIB File Download:** The 9220 provides an up-to-date copy of its MIBs. If you click on the **Save** button, a zip file with the relevant MIBs will be downloaded to your computer. This zip file contains the card MIBs, as well as the Ross Video and openGear MIBs required to compile the card MIBs.

The Admin General Tab is depicted below:

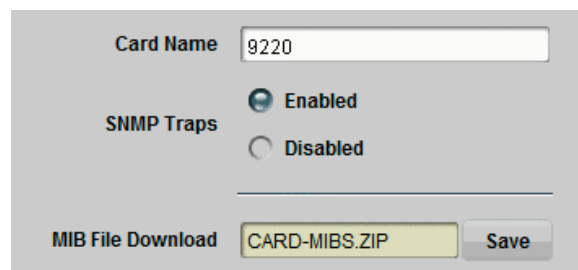

The screenshot shows a web-based configuration interface. At the top, there is a text input field labeled 'Card Name' containing the value '9220'. Below this, there are two radio button options for 'SNMP Traps': 'Enabled' (which is selected) and 'Disabled'. At the bottom of the form, there is a section labeled 'MIB File Download' containing a text input field with the value 'CARD-MIBS.ZIP' and a 'Save' button to its right.

Admin Firmware Tab

The 9220 can hold up to three distinct firmware images: a **Factory** image, and two upgrade images, called **Image 1** and **Image 2**. The Factory image can never be overwritten, and will always be available as a fall-back in case of problems or failed updates. Image 1 and Image 2 can be updated at will. Since the card offers two upgrade images, it is always possible to fall back to the previous image if there are any problems with the current one. The card will also automatically fall back to the factory image if it detects a corrupted firmware image. Finally, the push buttons on the front of the card allow for a forced override to the factory image, as described in the Front Switches section.

9220 firmware is updated in the same fashion as with any standard openGear™ card. Once you obtained the upgrade image from Cobalt Digital Inc., place it anywhere in your computer and click on the Dashboard **Upload** button, as shown below. A dialog box allows you to select the upgrade file. Note that you can simultaneously upgrade all of your 9220 cards over multiple chassis if you wish. For more detail, consult the **Dashboard User Manual**, chapter 6, section **Upgrading Device Software**. The Dashboard manual can be downloaded from:

<http://www.opengear.tv/n/?p=94>

³ SNMP is an optional feature in the openGear™ frame controller. The 9220 SNMP functions are only available if SNMP is licensed in the frame controller.

Note that uploading firmware to the 9220 does not affect its operation in any way and does not introduce any glitches in the inputs/outputs.

The fields in the Firmware Image Management tab are:

- **Factory Image, Image 1, and Image 2:** These contain version and release date information for the corresponding firmware images. If no image is present, this field will indicate **No Image**.
- **Upload Location:** This field contains the location where the image upload will go. The 9220 automatically chooses a location that will not overwrite the currently running image.
- **Boot Location:** This field indicates which image will be used in the next boot. If an image is successfully uploaded through Dashboard, this automatically changes to point to that image. It can also be manually changed.
- **Auto-Reboot After Update:** This field controls whether or not the 9220 will automatically reboot after a successful firmware upload through Dashboard. By default, the 9220 will **not** reboot after an update. You can upload the firmware at any time, and reboot later during a maintenance window.

Admin Config Files Tab

As you make configuration changes to the 9220, they are automatically persisted in non-volatile storage. If the card is rebooted or power-cycled, it will come back in the same configuration.

In addition to automatic configuration persistency, the 9220 also offers the ability to save up to 5 complete configurations, load them, and even export them. This can be used to quickly configure it for different scenarios, or for saving configuration “checkpoints” as a complex configuration is built. Since configurations can be exported, they can be archived outside the card as well.

Finally, the 9220 also offers 5 pre-saved configuration templates for some common scenarios.

The layout of the Admin Config Files tab is shown below.

The screenshot displays the Configuration Management interface, divided into two main sections: Configuration Management and Preset Configurations.

Configuration Management Table:

Config	Status	Name	Config	Config	Config	Download Config
1	Saved	User Manual Samples	Load	Delete	Save	Slot 5 9220 Config 1.ogd Save
2	Saved	Satellite Uplink Configuration	Load	Delete	Save	Slot 5 9220 Config 2.ogd Save
3	Saved	IPTV Distribution	Load	Delete	Save	Slot 5 9220 Config 3.ogd Save
4	Empty		Load	Delete	Save	Slot 5 9220 Config 4.ogd Save
5	Empty		Load	Delete	Save	Slot 5 9220 Config 5.ogd Save

Preset Configurations Table:

Status	Description	Template
OK	6 ASI in → 6 IP out (GbE 1)	Load
OK	6 ASI in → 6 IP out (GbE 2)	Load
OK	6 IP in (GbE 1) → 6 ASI out	Load
OK	6 IP in (GbE 2) → 6 ASI out	Load
OK	3 IP In(GbE 2)→ASI out, 3 ASI→IP out(GbE 1)	Load

Annotations in the image include:

- Configuration Management Table:** A red box highlights the entire table. A red arrow points from the "Saved configuration 3" label to the third row.
- Preset Configurations Table:** A red box highlights the entire table. A red arrow points from the "Pre-Defined Templates" label to the first row.
- Status Message Areas:** A red box highlights the "Clear Current Configuration" button at the bottom.

User-Saved Configurations

The fields in the user-saved configuration are:

- **Status:** This indicates whether there is a saved configuration on that particular slot. It will contain the words **Saved** or **Empty**.
- **Name:** This is an optional name for the configuration. It is not required but highly advisable. The name can be edited at any time (even when there is no saved configuration).
- **Config Load Button:** If you click on this button, the corresponding configuration is loaded in the 9220 card. It will replace the currently-running configuration. Dashboard™ will take a few seconds to reload (longer if you are accessing over a wide-area network), but the actual configuration in the 9220 is virtually instantaneous. The Status Message Area will indicate the result of the operation.
- **Config Delete Button:** If you click on this button, the corresponding configuration and its description are deleted.
- **Config Save Button:** If you click on this button, the current card configuration is saved on the corresponding slot, possibly replacing the configuration saved there if it is not empty.
- **Download Config:** If you click on the **Save** button, the corresponding file is downloaded to your computer. This feature is provided to allow configuration backups.

If you save a configuration to your computer, and later wish to restore it to the 9220, use the following procedure:

1. On Dashboard™, open the user interface for the frame controller (slot 0).
2. Select the **Data Safe** tab in the configuration area.
3. Uncheck the **Disable** checkbox corresponding to the card you wish to restore the configuration. This step is depicted below.

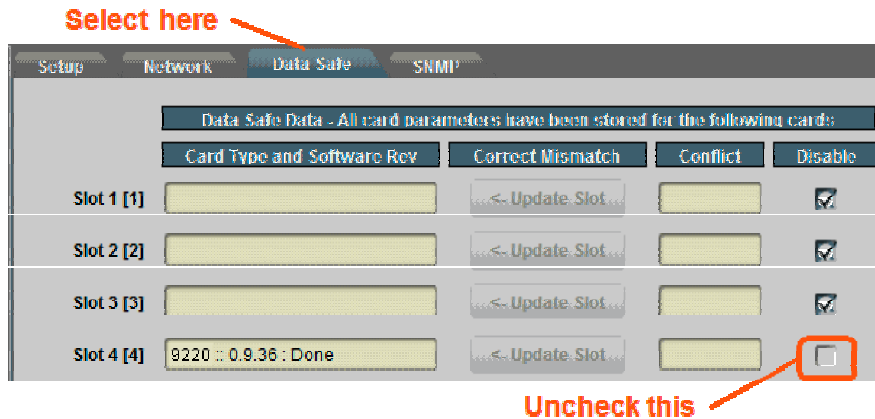

4. On the Dashboard™ Tree View, right-click on the card, and select **Restore Configuration**. Follow the prompts and navigate to the file you wish to restore. This process is illustrated below

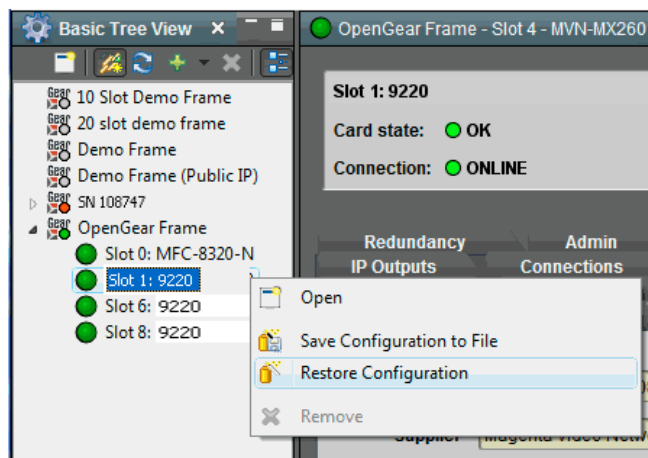

This process is discussed in further detail in the **Dashboard User Manual**, chapter 5, section **Restoring Configurations to Devices**.

Pre-defined Templates

The 9220 offers 5 pre-defined configuration templates, as indicated below.

Status	Description	Template
OK	6 ASI in → 6 IP out (GbE 1)	Load
OK	6 ASI in → 6 IP out (GbE 2)	Load
OK	6 IP in (GbE 1) → 6 ASI out	Load
OK	6 IP in (GbE 2) → 6 ASI out	Load
OK	3 IP In(GbE 2)→ASI out, 3 ASI→IP out(GbE 1)	Load

To load a template, just click on the **Load** button next to it. The pre-defined templates are;

- **6 ASI in → 6 IP out (GbE 1)**: This template configures all six ASI Ports as inputs, and connects them to six IP Outputs on Ethernet Port 1.
- **6 ASI in → 6 IP out (GbE 2)**: This template configures all six ASI Ports as inputs, and connects them to six IP Outputs on Ethernet Port 2.
- **6 IP in (GbE 1) → 6 ASI out**: This template configures all six ASI Ports as outputs, and connects them to six IP Inputs from Ethernet Port 1.
- **6 IP in (GbE 2) → 6 ASI out**: This template configures all six ASI Ports as outputs, and connects them to six IP Inputs from Ethernet Port 2.
- **3 IP In(GbE 2)→ASI out, 3 ASI→IP out(GbE 1)**: This template configures the first three ASI Ports as outputs, and connects them to three IP Inputs from Ethernet Port 2. It configures the remaining ASI Ports as inputs, and connects them to three IP Outputs on Ethernet Port 1.

Clear Current Configuration Button

The **Clear Current Configuration** button clears all the configured ports and streams as follows:

- All ASI Ports are disabled.
- All IP Inputs are deleted.
- All IP Outputs are deleted.
- All Connections are removed.
- The Test Packet Generator is disabled.

The button does not affect the following areas:

- The settings in the **Network** tab are not changed.
- The settings in the **Admin General** tab are not changed.
- Saved configurations are not modified in any way.

Dashboard™ will take a few seconds to reload (longer if you are accessing over a wide-area network), but the actual configuration in the 9220 is virtually instantaneous. The Status Message Area will indicate the result of the operation.

Admin Test Packet Generator Tab

The 9220 includes a Test Packet Generator (TPG) that is capable of generating a configurable constant bit rate sequence of MPEG-2 Transport Packets with very strict timing. The TPG is considered an input port, and is available to be connected to any output port. As with any input in the 9220, it supports up to 8 connections. The user interface for the TPG is depicted below:

The screenshot shows the 'Test Packet Generator' GUI. It is divided into two main sections: 'Current Configuration' and 'Modify Configuration'.
In the 'Current Configuration' section, there are three input fields: 'Mode' set to 'Ramp48 Packets', 'PID (hex)' set to '100', and 'Bit Rate (bps)' set to '15,000,000'.
In the 'Modify Configuration' section, there are four radio button options for 'Mode': 'Disabled', 'NULL Packets', 'Ramp48 Packets' (which is selected), and 'PCR Packets'. Below these are two input fields: 'PID (hex)' set to '100' and 'Bit Rate (bps)' set to '15000000'. At the bottom of this section is an 'Apply Settings' button.

To configure the TPG, make your selections in the **Modify Configuration** area of the GUI, and click on **Apply Settings**. The TPG configuration parameters are:

- **Mode:** controls the type of MPEG-2 transport packets generated. The options are:
 - **Disabled:** TPG is disabled. No packets are being generated.
 - **NULL Packets:** TPG is generating NULL packets. If you select this option, the **PID** parameter becomes read-only with the value 1FFF.
 - **Ramp48 Packets:** TPG is generating packets with a “Ramp48 Payload”. A “Ramp48 Payload” is composed of the bytes 0x48, 0x49, 0x4A, ..., 0xFF. Generated packets have the Payload bit set, no Adaptation Field, and a valid Continuity Counter field. On request, Cobalt Digital Inc. can supply a test program for Windows or Linux that receives the Ramp48 packets and checks them.
 - **PCR Packets:** TPG is generating packets with a valid PCR field (stamped corresponding to the packet’s departure time at the configured bit rate). The packets have a small payload with random data, so the Continuity Counter field is valid and counting.
- **PID (hex):** controls the PID of the generated packets. This is specified in hexadecimal.
- **Bit Rate (bps):** controls the bit rate of the generated packets. The minimum value is 64,000 bps and the maximum value is 213,000,000 bps.

Admin License Keys Tab

The 9220 has a number of optional licensable features. The Admin License Keys Tab is used to manage these features. Using this tab, you can see how many licenses you have for each optional feature, and how many you are currently using.

The 9220 has the concept of a temporary license. If you want to try out a certain feature, contact Cobalt Digital Inc. You will receive a license key that enables that feature for a specific period of running time (license time does not “count” when the card is off).

The Admin License Keys Tab includes a License Status table, and a configuration area, as shown below. The table rows are license counts, and the columns correspond to different licensable features. The rows are:

- **Permanent Licenses:** This is the number of non-expiring licenses for each feature.
- **Temporary Licenses:** This is the number of temporary licenses for each feature. Once the license period expires, they are removed.
- **Total Licenses:** This is the total number of licenses for each feature. It is simply the sum of the permanent and temporary licenses.
- **Used Licenses:** This is the number of licenses in use for each feature by the current card configuration.

If you have temporary licenses, the **Time Remaining** field indicates how long until they expire. If you do not have temporary licenses, this field has the message “No active temporary licenses”.

The table columns correspond to the licensable features, as follows:

- **Enable GE2:** Use of Ethernet Port 2 is subject to licensing. Only one license is required to enable the port. This field will have 1 if Ethernet Port 2 is licensed or in use.
- **TS Outputs:** The 9220 requires one license per transport stream output (ASI or IP). This column provides a count of outputs licensed and in use.
- The remaining columns correspond to features not yet available. Cobalt Digital Inc. if you need more information, or if you want to be notified when they become available.

Feature	License Status					
	Enable GE2	TS Outputs	SMPTE 2022	Filtering	Multiplexing	Splitting
Permanent Licenses	1	19	0	0	0	0
Temporary Licenses	0	2	0	0	0	0
Total Licenses	1	21	0	0	0	0
Used Licenses	1	2	0	0	0	0
Time Remaining	2 days, 17 hours					
	License Key Installed OK					
License Key	<input type="text"/>					
	<input type="button" value="Apply License Key"/>					
Serial Number	02301d505058					

If you want to request a license key from Cobalt Digital Inc., you will need to provide the card serial number. It can be found in the Product Tab and in the Admin License Key Tab as well. Once you receive the key from Cobalt Digital Inc., enter it in the **License Key** field shown above, and click on the **Apply License Key** button. If the key is accepted, you will see the message *License Key Installed OK*, as illustrated above. If there are any problems, you will see an error message in the same location. The following are the possible error messages:

- **Invalid key: missing characters:** the key you entered is too short. Double-check that you entered all the characters.
- **Invalid/Corrupted Key:** the key you entered has the correct number of characters, but it is invalid. Double check what you entered.
- **Serial number mismatch: this key is for serial xxxxxxxxxxxx:** 9220 license keys are specific to a card. You entered a valid license key, but it is intended for a different card, whose serial number is displayed in the message. You must use this key on the correct card.
- **This key has already been applied:** License keys can only be applied once. This is a valid key for this card, but you have already applied it, and its features are already available.

Admin Event Log Tab

The 9220 includes an Event Log in non-volatile storage. This event log can be used for fault-finding, and to check for error conditions. The following information is included in each 9220 event in the log:

- **Date:** The calendar date in which the event occurred.
- **Time:** The time at which the event occurred.
- **Severity:** The severity of the event. The 9220 defines three severity levels:
 - **Error:** These are events that affect the operation of the device. For example, an ASI Input losing lock or an IP Input no longer receiving packets. An error will impact service until addressed.
 - **Warning:** These are events that may produce visible glitches, but they do not have a continuous service impact. Examples of warnings are automatic redundancy switches and ARP renewal failures.
 - **Info:** These are informational events. All configuration actions are logged with this severity. When an error is cleared (for example, an ASI Input regains lock), the event is logged with this severity as well.
- **Subsystem:** The subsystem affected by the event. This may be a port, a stream, or the card itself.
- **Event:** This is a textual description of the event.

The 9220 does not have a battery-backed real-time clock. It depends on the frame controller to obtain the current date and time, and the frame controller depends on an external Network Time Protocol (NTP) server to obtain current date and time. By default, the 9220 will initialize its

internal time-of-day clock to January 1, 2010, GMT. If the frame controller is NTP-synchronized, the 9220 will then accept time from it and set its time-of-day clock accordingly.

In order to configure the frame controller for NTP, open its configuration screen on Dashboard™, select the **Network** Tab, and enter the IP address of an available NTP server:

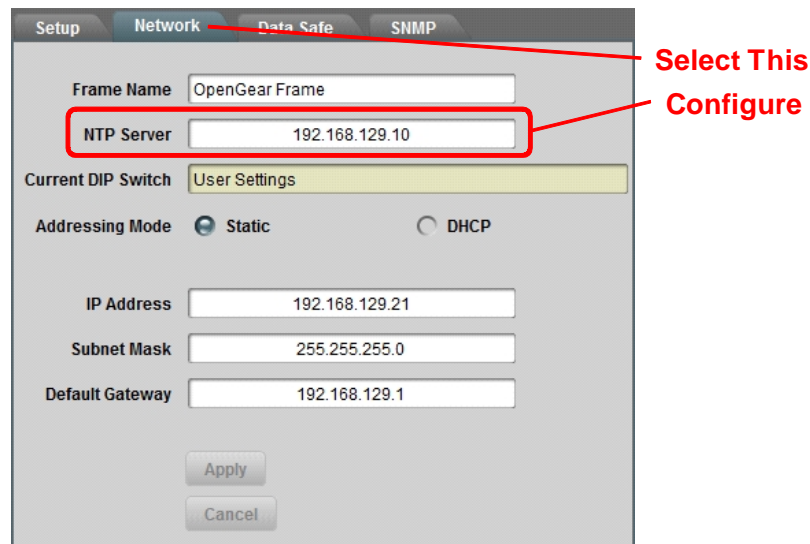

If your frame controller has access to the Internet, you can point it to one of the public NTP servers for your region. You can find more details on this link:

<http://psp2.ntp.org/bin/view/Servers/WebHome>

The full Admin Event Log tab is displayed below:

Log Download 9220 Slot 1 Log.csv Save

Log View All Error Warning Info

Event Log				
Date	Time	Severity	Subsystem	Event
04/02/10	16:23:17	Error	ASI Port 1	RX Unlocked
04/02/10	16:23:16	Info	ASI Port 1	Configured: RX
04/02/10	16:22:29	Info	System	DataSafe restore finish
04/02/10	16:22:28	Info	System	Time zone changed to GMT-7
04/02/10	16:22:28	Info	Ethernet 2	Configured: IGMP version set to Auto-Detect
04/02/10	16:22:28	Info	Ethernet 2	Configured: Alarm on Link Loss Enabled
04/02/10	16:22:28	Info	Ethernet 2	Configured: address 10.10.10.10 mask 255.255.255.0 gateway 0.0.0.0
04/02/10	16:22:28	Info	Ethernet 1	Configured: IGMP version set to Auto-Detect
04/02/10	16:22:28	Info	Ethernet 1	Configured: Alarm on Link Loss Enabled
04/02/10	16:22:28	Info	Ethernet 1	Configured: address 10.10.9.10 mask 255.255.255.0 gateway 0.0.0.0

Time Zone GMT-7

Current Time Fri Apr 2 16:24 2010

Clear Log Display

Notes
9220 time starts at 01/01/2010, 00:00
9220 will accept NTP from control card

The fields are:

- **Log Download:** The user interface only displays the last 10 events of each type. If you would like to see the whole event log, it can be downloaded to your computer by clicking on the **Save** button. The log will be in CSV format, and it can be opened by any utility that can read text files; ideally, you should use a spreadsheet program such as Microsoft Excel or similar so it is presented in tabular format. The log will be in chronological order, oldest entry to newest.
- **Log View:** The user interface can display the last 10 events. You can choose to see the last 10 events of any kind by selecting **All**, or you can restrict the view only to **Info**, **Warning**, or **Error**.
- **Event Log:** This table presents the last 10 events of the selected type.
- **Time Zone:** To simplify the correlation of the events with your local time, you can set your time zone using this drop-down menu. Note that the 9220 presents a simplified list, with standard GMT offsets. Note that standard GMT offsets do not change back and forth with Daylight Savings; you will need to make this adjustment manually if it is relevant to you.

-
- **Current Time:** This field indicates the 9220 view of what the current date and time is. If your frame is not NTP-synchronized, this is useful to figure out “how long ago did this event happen”.
 - **Clear Log Display:** If you click on this button, it clears all log views. This is useful to quickly identify any new events after the unit has been set up. Note that this action does not clear the logs stored in non-volatile memory.

The 9220 will store up to about 400 kBytes of logs in non-volatile memory. When that limit is reached, the oldest half of the stored logs will be deleted to make space for new logs.

Warranty and Repair Policy

Cobalt Digital Inc. Limited Warranty

This product is warranted to be free from defects in material and workmanship for a period of five (5) years from the date of shipment to the original purchaser, except that 4000, 5000, 6000, 8000 series power supplies, and Dolby® modules (where applicable) are warranted to be free from defects in material and workmanship for a period of one (1) year.

Cobalt Digital Inc.'s ("Cobalt") sole obligation under this warranty shall be limited to, at its option, (i) the repair or (ii) replacement of the product, and the determination of whether a defect is covered under this limited warranty shall be made at the sole discretion of Cobalt.

This limited warranty applies only to the original end-purchaser of the product, and is not assignable or transferrable therefrom. This warranty is limited to defects in material and workmanship, and shall not apply to acts of God, accidents, or negligence on behalf of the purchaser, and shall be voided upon the misuse, abuse, alteration, or modification of the product. Only Cobalt authorized factory representatives are authorized to make repairs to the product, and any unauthorized attempt to repair this product shall immediately void the warranty. Please contact Cobalt Technical Support for more information.

To facilitate the resolution of warranty related issues, Cobalt recommends registering the product by completing and returning a product registration form. In the event of a warrantable defect, the purchaser shall notify Cobalt with a description of the problem, and Cobalt shall provide the purchaser with a Return Material Authorization ("RMA"). For return, defective products should be double boxed, and sufficiently protected, in the original packaging, or equivalent, and shipped to the Cobalt Factory Service Center, postage prepaid and insured for the purchase price. The purchaser should include the RMA number, description of the problem encountered, date purchased, name of dealer purchased from, and serial number with the shipment.

Cobalt Digital Inc. Factory Service Center

2406 E. University Avenue

Urbana, IL 61802 USA

www.cobaltdigital.com

Office: (217) 344-1243

Fax: (217) 344-1245

Email: info@cobaltdigital.com

THIS LIMITED WARRANTY IS EXPRESSLY IN LIEU OF ALL OTHER WARRANTIES EXPRESSED OR IMPLIED, INCLUDING THE WARRANTIES OF MERCHANTABILITY AND FITNESS FOR A PARTICULAR PURPOSE AND OF ALL OTHER OBLIGATIONS OR LIABILITIES ON COBALT'S PART. ANY SOFTWARE PROVIDED WITH, OR FOR USE WITH, THE PRODUCT IS PROVIDED "AS IS." THE BUYER OF THE PRODUCT ACKNOWLEDGES THAT NO OTHER REPRESENTATIONS WERE MADE OR RELIED UPON WITH RESPECT TO THE QUALITY AND FUNCTION OF THE GOODS HEREIN SOLD. COBALT PRODUCTS ARE NOT AUTHORIZED FOR USE IN LIFE SUPPORT APPLICATIONS.

COBALT'S LIABILITY, WHETHER IN CONTRACT, TORT, WARRANTY, OR OTHERWISE, IS LIMITED TO THE REPAIR OR REPLACEMENT, AT ITS OPTION, OF ANY DEFECTIVE PRODUCT, AND SHALL IN NO EVENT INCLUDE SPECIAL, INDIRECT, INCIDENTAL, OR CONSEQUENTIAL DAMAGES (INCLUDING LOST PROFITS), EVEN IF IT HAS BEEN ADVISED OF THE POSSIBILITY OF SUCH DAMAGES.

Contact Us

Contact Cobalt Digital Inc.

PHONE	General Business Office and Technical Support	217.344.1243
	Fax	217.344.1245
E-MAIL	General Information	Info@cobaltdigital.com
	Sales Information	Sales@cobaltdigital.com
POSTAL SERVICE	Cobalt Digital Inc.	2406 East University Avenue Urbana, IL 61802 USA

Visit us at the Cobalt Digital Inc. website.

<http://www.cobaltdigital.com/>

- Online catalog
- Related products and full product lines
- Trade show information
- Dealer information
- Cobalt Digital Inc. news