



KRAMER ELECTRONICS LTD.

USER MANUAL

MODEL:

TBUS-201xl
Pop-up Table Connection Bus

P/N: 2900-300292 Rev 1



TBUS-201xl Quick Start Guide

This guide helps you install and use your product for the first time. For more detailed information, go to http://www.kramerelectronics.com/support/product_downloads.asp to download the latest manual or scan the QR code on the left.

Step 1: Check what's in the box

- TBUS-201xl Dual Pop-up Table Connection Bus
- 2 table clamps
- 1 cut out template
- 1 quick start guide

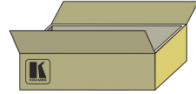

Save the original box and packaging materials in case you need to return your product for service.

Step 2: Prepare the TBUS-201xl for mounting

Install the required power socket.

Note that the power socket is purchased separately.

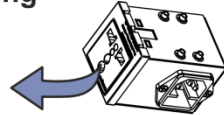
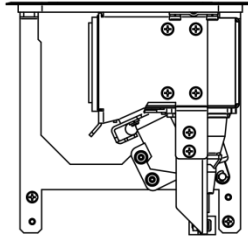

Step 3: Prepare the table for mounting

Cut out an opening in the table using the cut out template.

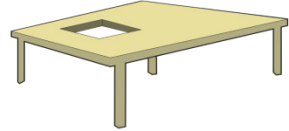

Step 4: Install the TBUS-201xl to the table

Insert the unit through the table opening.

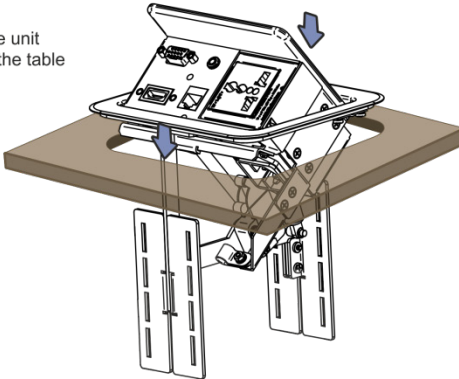

Mount the Brackets, secure the unit to the table and connect the cables.

Contents

1	Introduction	1
2	Getting Started	2
2.1	Achieving the Best Performance	2
2.1	Recycling Kramer Products	3
3	Overview	4
4	Defining the TBUS-201xl	5
4.1	The TBUS-201xl Connecting Surface	6
4.2	Power Socket Options	7
5	Installing the TBUS-201xl	8
5.1	Cutting an Opening	8
5.2	Installing the Power Socket	10
5.3	Inserting the TBUS-201xl through the Cut-Out Opening	11
5.4	Connecting the Cables	11
6	Technical Specifications	12

Figures

Figure 1:	TBUS-201xl Pop-up Table Connection Bus	4
Figure 2:	Defining the Parts of the TBUS-201xl Pop-up Table Connection Bus	5
Figure 3:	TBUS-201xl Connecting Surface	6
Figure 4:	Cut out Dimensions (not to scale)	9
Figure 5:	TBUS-201xl Universal Power Socket Housing	10
Figure 6:	Power socket installed	10

1 Introduction

Welcome to Kramer Electronics! Since 1981, Kramer Electronics has been providing a world of unique, creative, and affordable solutions to the vast range of problems that confront video, audio, presentation, and broadcasting professionals on a daily basis. In recent years, we have redesigned and upgraded most of our line, making the best even better!

Our 1,000-plus different models now appear in 11 groups that are clearly defined by function: GROUP 1: Distribution Amplifiers; GROUP 2: Switchers and Routers; GROUP 3: Control Systems; GROUP 4: Format/Standards Converters; GROUP 5: Range Extenders and Repeaters; GROUP 6: Specialty AV Products; GROUP 7: Scan Converters and Scalers; GROUP 8: Cables and Connectors; GROUP 9: Room Connectivity; GROUP 10: Accessories and Rack Adapters and GROUP 11: Sierra Video Products.

Thank you for purchasing the Kramer **TBUS-201xl** Pop-up Table Connection Bus, which is ideal for boardrooms, conference and training rooms!

2 Getting Started

We recommend that you:

- Unpack the equipment carefully and save the original box and packaging materials for possible future shipment
- Review the contents of this user manual



Go to <http://www.kramerelectronics.com> to check for up-to-date user manuals, a complete list of Kramer wall plates and module connectors, application programs, and to check if firmware upgrades are available (where appropriate).

2.1 Achieving the Best Performance

To achieve the best performance:

- Use only good quality connection cables (we recommend Kramer high-performance, high-resolution cables) to avoid interference, deterioration in signal quality due to poor matching, and elevated noise levels (often associated with low quality cables)
- Do not secure the cables in tight bundles or roll the slack into tight coils
- Avoid interference from neighboring electrical appliances that may adversely influence signal quality
- Position your Kramer **TBUS-201xl** away from moisture, excessive sunlight and dust



This equipment is to be used only inside a building. It may only be connected to other equipment that is installed inside a building.

Do not place heavy objects on top of the **TBUS-201xl**.

2.1 Recycling Kramer Products

The Waste Electrical and Electronic Equipment (WEEE) Directive 2002/96/EC aims to reduce the amount of WEEE sent for disposal to landfill or incineration by requiring it to be collected and recycled. To comply with the WEEE Directive, Kramer Electronics has made arrangements with the European Advanced Recycling Network (EARN) and will cover any costs of treatment, recycling and recovery of waste Kramer Electronics branded equipment on arrival at the EARN facility. For details of Kramer's recycling arrangements in your particular country go to our recycling pages at <http://www.kramerelectronics.com/support/recycling/>.

3 Overview

The **TBUS-201xl** is a furniture-mounted pop-up connection bus that is easily installed into a table or podium top. The **TBUS-201xl** interface enables you to connect any equipment to systems installed in a room via the following pass-through connectors:

- 1 PC on a 15-pin HD connector
- 1 HDMI connector
- 1 stereo audio on a 3.5mm connector
- 1 Ethernet RJ-45 connector

When not in use, you can lower the **TBUS-201xl** flush into the table. The example in [Figure 1](#) shows the **TBUS-201xl** in a table or podium top with a universal power socket.

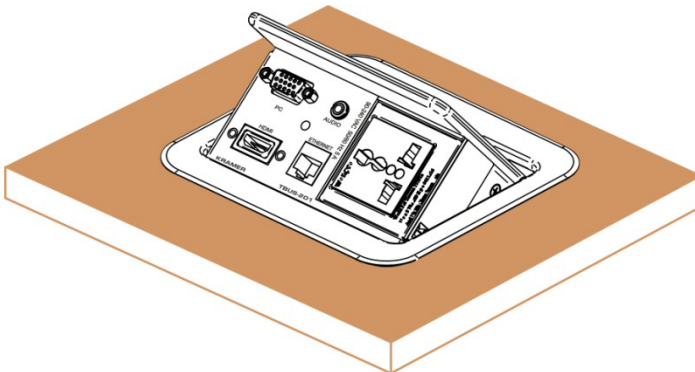

Figure 1: TBUS-201xl Pop-up Table Connection Bus

In addition, the **TBUS-201xl** is:

- Easily opened and closed by pressing down gently on the lid due to its tilting angular construction, pneumatic lift and mechanical latching mechanism. It can be raised (when in use) or lowered (when not in use)
- Suitable for any of the following power sockets: for the USA, the UK, Germany (the Europlug), Belgium-France, Switzerland, Italy, Australia, Brazil, Israel, South Africa or “Universal” for use anywhere (see compatibility restrictions in [Section 4.2](#))

Order the power sockets separately from Kramer Electronics

4 Defining the TBUS-201xl

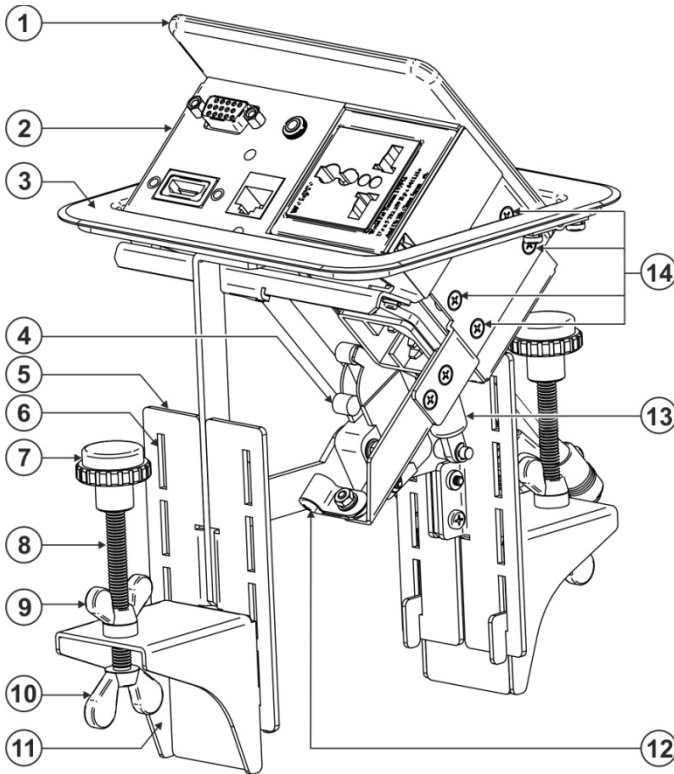

Figure 2: Defining the Parts of the TBUS-201xl Pop-up Table Connection Bus

#	Feature	Function
1	Black anodized or brushed anodized aluminum semi-automatic lid	Covers the connecting surface, leaving the table surface neat and tidy
2	Connecting Surface	See Section 4.1
3	Outer Rim	Fits over the table surface
4	Mini Latch	Enables the closing and opening of the lid by slightly pressing it
5	Mounting Clamp Plates	For holding the clamps
6	Mounting Clamp Slits (four sets on each side)	Insert the mounting clamps to the slits when installing the TBUS-201xl
7	Rubber Protectors (2)	To ensure soft tightening to the table underside
8	Mounting Screws (2)	For securing the TBUS-201xl to the table
9	Locking Butterfly Nuts (2)	Tighten to lock the mounting butterfly screw

#	Feature	Function
10	Mounting Butterfly Nuts (2)	Tighten to secure the unit to the table surface
11	Mounting Clamps (2 units)	Place in the clamp slits after inserting the enclosure into the table – for securing the unit to the table surface
12	Power Connector Lock	Secures the power cable so it does not accidentally disconnect when opening the lid
13	Pneumatic Piston	Enables automatic lifting and smooth closing of the lid
14	Power Socket Opening Screw Holes (4)	For installing/replacing the power socket

4.1 The TBUS-201xl Connecting Surface

[Figure 3](#) defines the connecting surface and includes the universal power socket (sold separately) for illustration purposes only (note that although 'TBUS-201' is printed on the panel, the name of the modular product is **TBUS-201xl**):

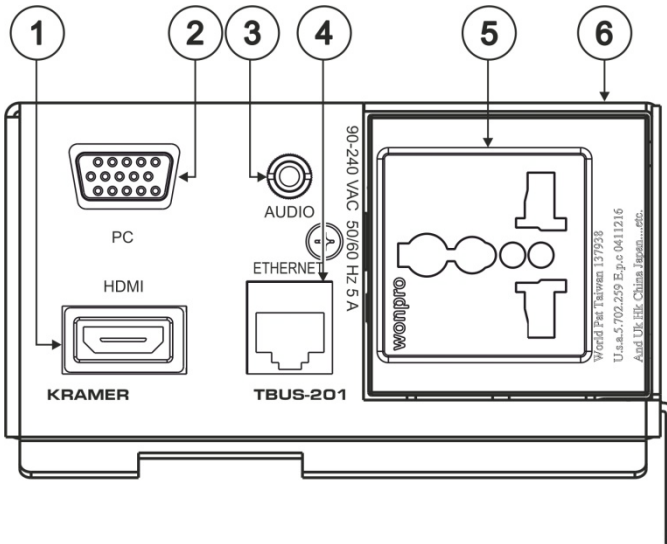







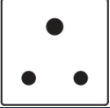

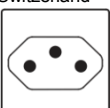
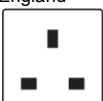

Figure 3: TBUS-201xl Connecting Surface

#	Feature	Function
1	HDMI Connector	Connect to an HDMI source
2	PC 15-pin HD Connector	Connect to a computer graphics source
3	AUDIO 3.5mm Mini Jack	Connects to an unbalanced stereo audio source
4	ETHERNET Connector	Connects to the PC or other Controller through computer networking
5	Power Socket Opening	Suitable for various power sockets (see Section 4.2)
6	Connecting Surface	Pops up when gently pressing the lid

4.2 Power Socket Options

A choice of power sockets is available for purchase in several versions, including power sockets for the USA, Brazil, Germany (the Europlug), UK, Switzerland, Belgium-France, Italy, South Africa, Israel and Australia. A “Universal” socket for general use is also available (see the compatibility restrictions in the table below). Note that the photos below are for illustration purposes only.

Power Socket Type	Power Specs	Description	
Universal: 	TS-201U (80-000043) 100-240V AC, 50/60Hz, 5A Maximum 5A per power outlet	Fully compatible with power plugs in the UK, India, Italy and Denmark, as well as with the 2-prong Europlug. Partially compatible (if the polarity is reversed) with plugs in China, Switzerland, Israel and the USA. The universal socket does not supply grounding to plugs in Central Europe and France and so you should order country specific sockets instead. Not compatible with South African plugs.	
Power Socket Type	Power Specs	Power Socket Type	Power Specs
USA: 	TS-201US (80-000046) 100-125V AC, 50/60Hz, 5A Maximum 5A per power outlet	Italy: 	TS-201IT (80-000047) 100-240V AC, 50/60Hz, 5A Maximum 5A per power outlet
Germany and EU: 	TS-201DE (80-000044) 100-240V AC, 50/60Hz, 5A Maximum 5A per power outlet	Australia: 	TS-201AU (80-000050) 100-240V AC, 50/60Hz, 5A Maximum 5A per power outlet
Belgium and France: 	TS-201FR (80-000045) 100-240V AC, 50/60Hz, 5A Maximum 5A per power outlet	Israel: 	TS-201IL (80-000053) 100-240V AC, 50/60Hz, 5A Maximum 5A per power outlet
South Africa 	TS-201ZA (80-000052) 100-240V AC, 50/60Hz, 5A Maximum 5A per power outlet	Brazil 	TS-201BR (80-000051) 100-240V AC, 50/60Hz, 5A Maximum 5A per power outlet
Switzerland 	TS-201CH (80-000049) 100-240V AC, 50/60Hz, 5A Maximum 5A per power outlet	England 	TS-201GB (80-000048) 100-240V AC, 50/60Hz, 5A Maximum 5A per power outlet

5 Installing the TBUS-201xl

To install the **TBUS-201xl** perform the following steps:

1. Cut an opening in the table (see [Section 5.1](#)).
2. Install the power socket (see [Section 5.2](#)).
3. Insert the **TBUS-201xl** through the cut-out opening (see [Section 5.3](#)).
4. Connect the cables (see [Section 5.4](#)).

5.1 Cutting an Opening

The metal cutout template (supplied) defines the surface you have to cut out to install your **TBUS-201xl**.



The thickness of the table should be 3in (76mm) or less.

To cut an opening in the table:

1. Before cutting the opening, confirm the dimensions of the cutout template and make sure that they have not changed.
2. Place the included cut out template (that is included with your **TBUS-201xl**) on the surface of the table exactly where you want to install the **TBUS-201xl**.
3. Attach the template to the table with the included screws (if using the cut out template).
4. Following the **inside** edge of the template, cut a hole in the table surface with a sabre or keyhole saw according to the dimensions shown in [Figure 4](#) (not to scale).

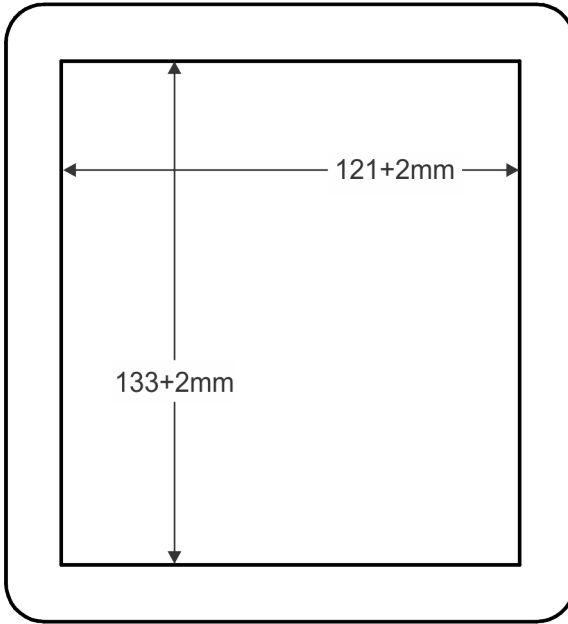

Figure 4: Cut out Dimensions (not to scale)

5. Unscrew and remove the template from the surface of the table and clean the table surface.

Take care not to damage the table.

If needed, you can download a full-scale template from our Web site.



Kramer Electronics is not responsible for any damage caused to the table.

5.2 Installing the Power Socket

[Figure 5](#) shows an example of the Universal power socket housing which is one of the optional power sockets for the **TBUS-201xl**, see [Section 4.2](#).

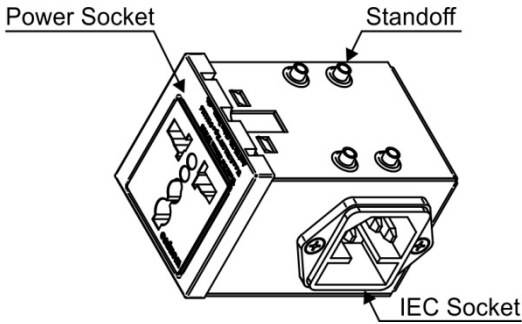

Figure 5: TBUS-201xl Universal Power Socket Housing

To install the power socket:

1. Close the **TBUS-201xl** lid.
2. Carefully insert the power socket housing so that the power socket fits into the power socket opening on the connecting surface and the four standoffs fit the four screw holes on the **TBUS-201xl**.
When positioned correctly, the IEC socket faces downwards.
3. Screw the four screws included in the power socket kit into the designated holes to fix the power socket housing in place (see [Figure 6](#)).

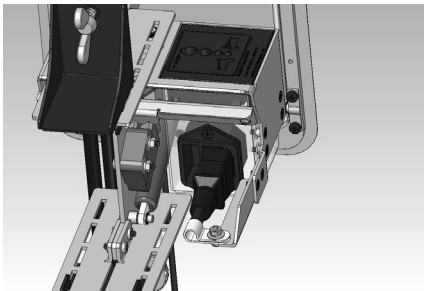

Figure 6: Power socket installed

4. Unscrew the power connector lock.

5. Connect the IEC power cord to the IEC socket.
6. Insert the power cord into the power connector lock and tighten the screw (see [Figure 2](#), item 12) to secure the power cable.

5.3 Inserting the TBUS-201xl through the Cut-Out Opening

To install the **TBUS-201xl**, do the following:

1. Carefully insert the unit into the prepared opening.
2. Take the support clamps under the table and place them into the support clamp late slits at the desired height (on both the front and rear sides of the unit).
3. Make sure that the upper outer rim is situated parallel to the edge of the table.
4. Insert the mounting screws through the holes in the mounting clamps. Tighten the mounting butterfly nuts to secure the unit to the table surface and then lock with the mounting butterfly screw.

5.4 Connecting the Cables

1. Connect the appropriate cables from underneath.
2. Secure the cables.
Do not keep the cord too tight or too loose.

Once you have connected the unit to the mains power and connected the proper cables, you may use the unit.

6 Technical Specifications

PORTS:	1 HDMI connector, 1 Ethernet RJ-45 connector, 1 15-pin HD connector, 1 3.5mm mini jack	
POWER SOURCE (AC power limits):	Power Socket Assemblies	
	Universal	100-240V AC, 50/60Hz, 5A Maximum 5A per power outlet
	<p>Fully compatible with power plugs in the UK, India, Italy and Denmark, as well as with the 2-prong Europlug.</p> <p>Partially compatible (if the polarity is reversed) with plugs in China, Switzerland, Israel and the USA. The universal socket does not supply grounding to plugs in Central Europe and France (you should order country specific sockets instead).</p> <p>Not compatible with South African plugs.</p>	
	USA	100-240V AC, 50/60Hz, 5A Maximum 5A per power outlet
	Germany and EU	100-240V AC, 50/60Hz, 5A Maximum 5A per power outlet
	Belgium and France	100-240V AC, 50/60Hz, 5A Maximum 5A per power outlet
	Italy	100-240V AC, 50/60Hz, 5A Maximum 5A per power outlet
	Australia	100-240V AC, 50/60Hz, 5A Maximum 5A per power outlet
	Israel	220V AC, 50/60Hz, 5A Maximum 5A per power outlet
	South Africa	220V AC, 50/60Hz, 5A Maximum 5A per power outlet
	Switzerland	220V AC, 50/60Hz, 5A Maximum 5A per power outlet
	England	220V AC, 50/60Hz, 5A Maximum 5A per power outlet
	Brazil	220V AC, 50/60Hz, 5A Maximum 5A per power outlet
FUSE RATING:	T 6.3A 250V	
OPERATING TEMPERATURE RANGE:	+5 to +45 Deg. Centigrade	
OPERATING HUMIDITY RANGE:	10 to 90% RHL, non-condensing	
STORAGE TEMPERATURE RANGE:	-20 to +70Deg. C.	
STORAGE HUMIDITY RANGE:	5 to 95% RHL, non-condensing	
DIMENSIONS:	Including the outer rim: 14.5cm x 13.2cm x 17.3cm (5.71" x 5.2" x 6.81") W, D, H Without the outer rim: 13.3cm x 12.0cm x 17.3cm (5.24" x 4.72" x 6.81") W, D, H	
WEIGHT:	0.85kg (1.87lbs) approx. 1.2kg (2.65lbs) approx. with mounting brackets 1.4 kg (3.1lbs) approx. packed product	
ACCESSORIES:	Cut out metal template	
OPTIONS:	Power socket kits, power cord	
Specifications are subject to change without notice at http://www.kramerelectronics.com		

LIMITED WARRANTY

The warranty obligations of Kramer Electronics for this product are limited to the terms set forth below:

What is Covered

This limited warranty covers defects in materials and workmanship in this product.

What is Not Covered

This limited warranty does not cover any damage, deterioration or malfunction resulting from any alteration, modification, improper or unreasonable use or maintenance, misuse, abuse, accident, neglect, exposure to excess moisture, fire, improper packing and shipping (such claims must be presented to the carrier), lightning, power surges, or other acts of nature. This limited warranty does not cover any damage, deterioration or malfunction resulting from the installation or removal of this product from any installation, any unauthorized tampering with this product, any repairs attempted by anyone unauthorized by Kramer Electronics to make such repairs, or any other cause which does not relate directly to a defect in materials and/or workmanship of this product. This limited warranty does not cover cartons, equipment enclosures, cables or accessories used in conjunction with this product.

Without limiting any other exclusion herein, Kramer Electronics does not warrant that the product covered hereby, including, without limitation, the technology and/or integrated circuit(s) included in the product, will not become obsolete or that such items are or will remain compatible with any other product or technology with which the product may be used.

How Long Does this Coverage Last

Seven years as of this printing; please check our Web site for the most current and accurate warranty information.

Who is Covered

Only the original purchaser of this product is covered under this limited warranty. This limited warranty is not transferable to subsequent purchasers or owners of this product.

What Kramer Electronics will do

Kramer Electronics will, at its sole option, provide one of the following three remedies to whatever extent it shall deem necessary to satisfy a proper claim under this limited warranty:

1. Elect to repair or facilitate the repair of any defective parts within a reasonable period of time, free of any charge for the necessary parts and labor to complete the repair and restore this product to its proper operating condition. Kramer Electronics will also pay the shipping costs necessary to return this product once the repair is complete.
2. Replace this product with a direct replacement or with a similar product deemed by Kramer Electronics to perform substantially the same function as the original product.
3. Issue a refund of the original purchase price less depreciation to be determined based on the age of the product at the time remedy is sought under this limited warranty.

What Kramer Electronics will not do Under This Limited Warranty

If this product is returned to Kramer Electronics or the authorized dealer from which it was purchased or any other party authorized to repair Kramer Electronics products, this product must be insured during shipment, with the insurance and shipping charges prepaid by you. If this product is returned uninsured, you assume all risks of loss or damage during shipment. Kramer Electronics will not be responsible for any costs related to the removal or re-installation of this product from or into any installation. Kramer Electronics will not be responsible for any costs related to any setting up this product, any adjustment of user controls or any programming required for a specific installation of this product.

How to Obtain a Remedy under this Limited Warranty

To obtain a remedy under this limited warranty, you must contact either the authorized Kramer Electronics reseller from whom you purchased this product or the Kramer Electronics office nearest you. For a list of authorized Kramer Electronics resellers and/or Kramer Electronics authorized service providers, please visit our web site at www.kramerelectronics.com or contact the Kramer Electronics office nearest you.

In order to pursue any remedy under this limited warranty, you must possess an original, dated receipt as proof of purchase from an authorized Kramer Electronics reseller. If this product is returned under this limited warranty, a return authorization number, obtained from Kramer Electronics, will be required. You may also be directed to an authorized reseller or a person authorized by Kramer Electronics to repair the product.

If it is decided that this product should be returned directly to Kramer Electronics, this product should be properly packed, preferably in the original carton, for shipping. Cartons not bearing a return authorization number will be refused.

Limitation on Liability

THE MAXIMUM LIABILITY OF KRAMER ELECTRONICS UNDER THIS LIMITED WARRANTY SHALL NOT EXCEED THE ACTUAL PURCHASE PRICE PAID FOR THE PRODUCT. TO THE MAXIMUM EXTENT PERMITTED BY LAW, KRAMER ELECTRONICS IS NOT RESPONSIBLE FOR DIRECT, SPECIAL, INCIDENTAL OR CONSEQUENTIAL DAMAGES RESULTING FROM ANY BREACH OF WARRANTY OR CONDITION, OR UNDER ANY OTHER LEGAL THEORY. Some countries, districts or states do not allow the exclusion or limitation of relief, special, incidental, consequential or indirect damages, or the limitation of liability to specified amounts, so the above limitations or exclusions may not apply to you.

Exclusive Remedy

TO THE MAXIMUM EXTENT PERMITTED BY LAW, THIS LIMITED WARRANTY AND THE REMEDIES SET FORTH ABOVE ARE EXCLUSIVE AND IN LIEU OF ALL OTHER WARRANTIES, REMEDIES AND CONDITIONS, WHETHER ORAL OR WRITTEN, EXPRESS OR IMPLIED. TO THE MAXIMUM EXTENT PERMITTED BY LAW, KRAMER ELECTRONICS SPECIFICALLY DISCLAIMS ANY AND ALL IMPLIED WARRANTIES, INCLUDING, WITHOUT LIMITATION, WARRANTIES OF MERCHANTABILITY AND FITNESS FOR A PARTICULAR PURPOSE. IF KRAMER ELECTRONICS CANNOT LAWFULLY DISCLAIM OR EXCLUDE IMPLIED WARRANTIES UNDER APPLICABLE LAW, THEN ALL IMPLIED WARRANTIES COVERING THIS PRODUCT, INCLUDING WARRANTIES OF MERCHANTABILITY AND FITNESS FOR A PARTICULAR PURPOSE, SHALL APPLY TO THIS PRODUCT AS PROVIDED UNDER APPLICABLE LAW.

IF ANY PRODUCT TO WHICH THIS LIMITED WARRANTY APPLIES IS A "CONSUMER PRODUCT" UNDER THE MAGNUSON-MOSS WARRANTY ACT (15 U.S.C.A. §2301, ET SEQ.) OR OTHER APPLICABLE LAW, THE FOREGOING DISCLAIMER OF IMPLIED WARRANTIES SHALL NOT APPLY TO YOU, AND ALL IMPLIED WARRANTIES ON THIS PRODUCT, INCLUDING WARRANTIES OF MERCHANTABILITY AND FITNESS FOR THE PARTICULAR PURPOSE, SHALL APPLY AS PROVIDED UNDER APPLICABLE LAW.

Other Conditions

This limited warranty gives you specific legal rights, and you may have other rights which vary from country to country or state to state.

This limited warranty is void if (i) the label bearing the serial number of this product has been removed or defaced, (ii) the product is not distributed by Kramer Electronics or (iii) this product is not purchased from an authorized Kramer Electronics reseller. If you are unsure whether a reseller is an authorized Kramer Electronics reseller, please visit our Web site at www.kramerelectronics.com or contact a Kramer Electronics office from the list at the end of this document.

Your rights under this limited warranty are not diminished if you do not complete and return the product registration form or complete and submit the online product registration form. Kramer Electronics thanks you for purchasing a Kramer Electronics product. We hope it will give you years of satisfaction.



For the latest information on our products and a list of Kramer distributors, visit our Web site where updates to this user manual may be found.

We welcome your questions, comments, and feedback.

Web site: www.kramerelectronics.com

E-mail: info@kramerel.com



SAFETY WARNING

Disconnect the unit from the power supply before opening and servicing



P/N: 2900-300292



Rev: 1