

TAHOMA MiniQ Multiviewers

HARDWARE MANUAL

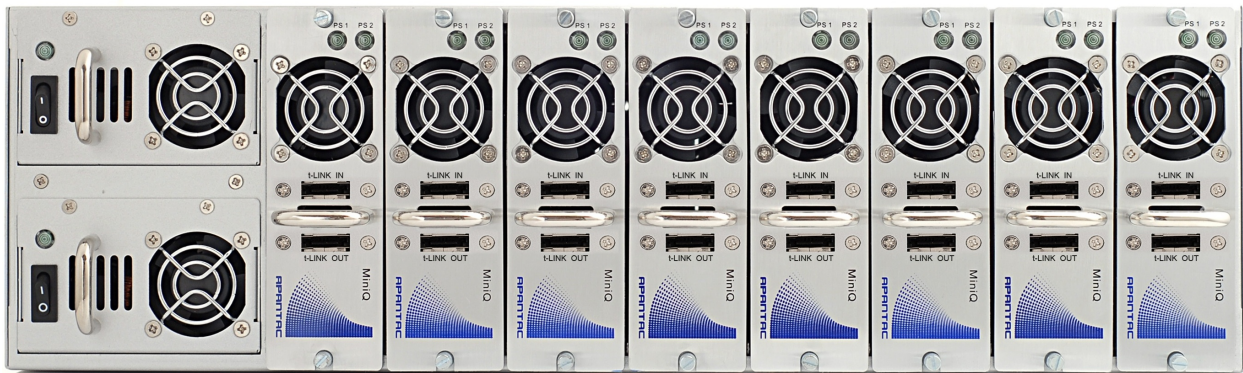

Version 1.0

Dated: November 19, 2012

© 2012 Apantac LLC - All rights reserved

The contents of this document are provided in connection with Apantac LLC ("Apantac") products. Apantac makes no representations or warranties with respect to the accuracy or completeness of the contents of this publication and reserves the right to make changes to specifications and product descriptions at any time without notice.

APANTAC, LLC. • 7556 SW BRIDGEPORT ROAD • PORTLAND, OR 97224, USA
PHONE +1 503 616 3711 • FAX +1 503 389 7921 • INFO@APANTAC.COM • WWW.APANTAC.COM

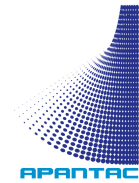
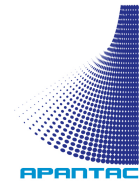

TABLE OF CONTENTS

<i>TRADEMARKS</i>	3
<i>COMPLIANCE INFORMATION</i>	3
<i>Limitation of Liability</i>	4
<i>Extended Warranty Options</i>	5
<i>Services and Repairs Outside the Warranty Period</i>	5
<i>Disclaimer</i>	5
<i>Operating Environment</i>	5
<i>INTRODUCTION TO TAHOMA MiniQ MULTIVIEWERS</i>	6
<i>HARDWARE</i>	6
<i>TAHOMA MiniQ PRODUCT</i>	7
<i>TECHNICAL SPECIFICATIONS</i>	8
<i>SPECIFICATIONS</i>	11
<i>PRODUCT CONTENTS - "WHAT'S IN THE BOX"</i>	14
<i>OPERATION</i>	18
<i>Optional Hardware</i>	18
<i>MiniQ MULTIVIEWER SETUP EXAMPLES</i>	19
<i>ACCESSORIES</i>	24
<i>Standard Accessories:</i>	24
<i>Optional Accessories:</i>	Error! Bookmark not defined.
<i>APPENDIX A: CONNECTORS</i>	25
<i>APPENDIX B: External DC POWER SUPPLIES</i>	29
<i>CONTACT APANTAC</i>	31



TRADEMARKS

Apantac, Tahoma, MT Hood, Crescent and Mazama are registered trademarks of Apantac LLC. All other trademarks are the property of their respective holders.

Notice:

Copyright © 2012 Apantac LLC. All rights reserved. All information in this manual is subject to change without notice. No part of the document may be reproduced or transmitted in any form, or by any means, electronic or mechanical, including photocopying or recording, without the express written permission of Apantac LLC.

COMPLIANCE INFORMATION

The Apantac equipment has been tested to comply with the following.

- FCC - Class A
This equipment has been tested and found to comply with the limits for a Class A digital device, pursuant to part 15 of the FCC Rules. These limits are designed to provide reasonable protection against harmful interference when the equipment is operated in a commercial environment. This equipment generates, uses, and can radiate radio frequency energy and, if not installed and used in accordance with the instruction manual, may cause harmful interference to radio communications. Operation of this equipment in a residential area is likely to cause harmful interference in which case the user will be required to correct the interference at his or her own expense.
- CE
- C-Tick
- RoHS

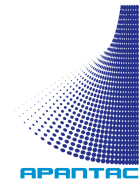

WARRANTY STATEMENT

Apantac LLC (herein after referred to as "Apantac") warrants to the original purchaser of the products manufactured by Apantac (the "Product,") will be free from defects in material and workmanship for a period of three (3) year from the date of shipment of the Product to the purchaser.

If the Product proves to be defective during the three (3) year warranty period, the purchaser's exclusive remedy and Apantac's sole obligation under this warranty is expressly limited, at Apantac's sole option, to:

- (a) repair the defective Product without charge for parts and labor or,
- (b) provide a replacement in exchange for the defective Product or,
- (c) if after a reasonable time, is unable to correct the defect or provide a replacement Product in good working order, then the purchaser shall be entitled to recover damages subject to the limitation of liability set forth below.

Limitation of Liability

Apantac's liability under this warranty shall not exceed the purchase price paid for the defective product. In no event shall Apantac be liable for any incidental, special or consequential damages, including without limitation, loss of profits for any breach of this warranty.

If Apantac replaces the defective Product with a replacement Product as provided under the terms of this Warranty, in no event will the term of the warranty on the replacement Product exceed the number of months remaining on the warranty covering the defective Product.

Equipment manufactured by other suppliers and supplied by Apantac carries the respective manufacturer's warranty. Apantac assumes no warranty responsibility either expressed or implied for equipment manufactured by others and supplied by Apantac.

This hardware warranty shall not apply to any defect, failure or damage:

- a) Caused by improper use of the Product or inadequate maintenance and care of the Product;
- b) Resulting from attempts by those other than Apantac representatives to install, repair, or service the Product;
- c) Caused by installation of the Product in a hostile operating environment or connection of the Product to incompatible equipment;

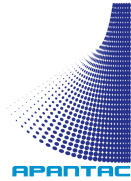

- d) Caused by the modification of the Product or integration with other products when the effect of such modification or integration increases the time or difficulties of servicing the Product. Any Product which fails under conditions other than those specifically covered by the Hardware Warranty, will be repaired at the price of parts and labor in effect at the time of repair. Such repairs are warranted for a period of ninety (90) days from date of reshipment to customer.

Extended Warranty Options

Apantac offers *OPTIONAL* Extended Warranty plans that provide continuous coverage for the Product after the expiration of the Warranty Period. Please contact an Apantac sales representative for details on the options that are available for your Apantac equipment.

Services and Repairs Outside the Warranty Period

Apantac makes its best offer to repair products that are outside the warranty period, provided the product has not reached its end of life.

Disclaimer

Use of this product is limited to the intended design purpose. Any damage caused by use other than the design purpose will void the above warranty.

Operating Environment

Apantac Tahoma Multiviewers should be operated in an environment that is safe for sensitive electronic equipment. It should not be placed in hot, dusty, or humid locations without adequate cooling, filtration, or ventilation.

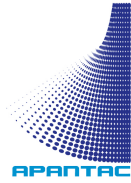

INTRODUCTION TO TAHOMA MiniQ MULTIVIEWERS

The Apantac Tahoma MiniQ Multiviewer platform displays multiple auto-detecting video inputs at different formats on a high resolution display up to resolutions of 1920x1200. The Tahoma MiniQ Platform combines the display of video windows, audio meters, label/UMD, tallies, alarms and indicators in a very space efficient package

HARDWARE

The Apantac Tahoma MiniQ Multiviewer Platform consists of the following

4 different sizes of mechanical frames to serve the needs of broadcast, professional AV and surveillance markets. These frames are ½ width of 1 RU, 1 RU, RU and 3RU. Each Multiviewer frame has a unique IP address, which allows a PC/laptop to easily connect and configure the display layouts.

1. MiniQ Module-> A quad video processor that allows 4 video inputs from CV, SD/HD-SDI to 3G SDI
2. MiniQ-3U-FR -> 3 rack unit frame that can house up to 8 MiniQ modules, comes with 2 MiniQ-3U-PS (hot swappable power supplies)
3. MiniQ-1U-FR -> 1 rack unit mounting plate that can provide rack mount for up to 3 MiniQ modules
4. MiniQ-1U-PS -> External DC power supply for single MiniQ module

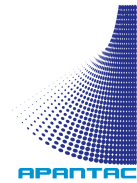

TAHOMA MiniQ PRODUCT

A fully configured MiniQ-3U-FR consists of 8 MiniQ modules. It can accept up to 32 various video standards (from analog composite to HD-SDI and 3G) and comes standard with

- 16 channels of embedded audio per every SDI video input
- 1 HDMI/DVI extender RJ45 outputs
- 1 SDI output
- 8 GPI (RJ50)
- 1 IP port (RJ45)
- 1 Analog audio monitoring output (Phoenix connector)

The MiniQ modules can be cascaded together with t-Link cables to freely configure its Flexible outputs.

*Flexible Outputs Examples:

Table 1: Flexible outputs

Output(s)								
	1	2	3	4	5	6	7	8
Inputs	4	4	4	4	4	4	4	4
Inputs	4	4	4	4	4	4	8	
Inputs	4	4	4	4	8		8	
Inputs	4	4	8		8		8	
Inputs	4	4	4	4	8	12		
Inputs	8		8		8		8	
Inputs	8		16				4	4
Inputs	4	8		8		12		
Inputs	4	4	8		16			
Inputs	8		12			12		
Inputs	4	12			16			
Inputs	8		8		16			
Inputs	4	8		20				
Inputs	4	4	24					
Inputs	4	28						

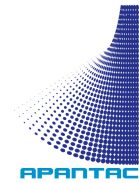

Inputs	8	24
Inputs	12	20
Inputs	16	16
Inputs	32	

TECHNICAL SPECIFICATIONS

- Auto detect 3G/HD-SD/SDI/CV 50/60Hz
- Output resolution up to 1920x1200/1080p
- Digital clock can be synchronized with NTP
- Up to 30 presets for display layout
- Presets can be recalled via GPI or ASCII protocol via network
- Auto-detect aspect ratio between 16x9 and 4x3
- Communication interface via IP or RS232
- Supports Apantac eXtended Protocol (AXP)
- Supports direct TSL tally/UMD interface
- Supports multiple languages (including 2 byte characters)
- Supports SDI output (optional)

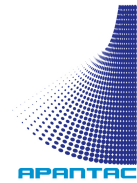

Table 2: Serial Video input

Standards	Upgradable to 3Gb/s (SMPTE 424M) HD-SDI (SMPTE 292M) SD-SDI (SMPTE 259M-C) PAL/NTSC
Connector	BNC
Equalization	Automatic to 140m (Belden 1694A)
Return Loss	15db up to 270mb/s
Embedded Audio	SMPTE 272-A

Table 3: Video Formats supported

480i	720p/30	1080p/23.98	2048x1080p/23.98
480p	720p/50	1080p/24	2048x1080p/24
576i	720p/59.94	1080p/25	
576p	720p/60	1080p/29.97	
720p/23.98	1035i/59.94	1080p/30	
720p/24	1035i/60	1080sf/23.98	
720p/25	1080i/50	1080sf/24	
720p/29.97	1080i/59.94	1080sf/30	

Table 4: Display Output

Standards	DVI-D, HDMI 1.2/3, VGA up to 1920x1200, SDI
Connector	RJ45 (with transmitter), BNC
Impedance	100Ω, 75Ω

Table 5: Audio Outputs

Type	Number/type/connector	Location	Adjustment
Stereo Analog	1 / unbalanced / phoenix connector	Rear Panel	None, Line Level

Table 6: Output Resolution (50 and 60Hz)

720x480	852x480	1024x768	1280x768
800x600	1280x960	1280x1024	1360x768
1280x800	1400x1050	1600x1200	1680x1050
1366x768	1920x1080	1920x1200	

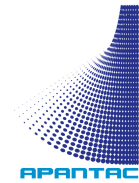

Table-7: General Purpose Interface I/O

Number	On MiniQ Module
8	Assignable to input or output
Connector	RJ50 to DB9

Figure 1: GPI/O Electrical Characteristics

Table 8: Serial Port

Number of Ports	1 x RS232
Adapter	RS232 to RS422 or RS485 (optional)
Connector	RJ45
Baud Rate	Up to 115200
UMD support	Native to TSL and TSI, other third party protocols via Apantac UIM*

Table 9: Ethernet

Network Type	Fast Ethernet 100 Base-TX
Connector	RJ45
Cable	Auto-detect. Either straight or crossed cable will work
UMD support	Native to TSL and TSI, other third party protocols via Apantac UIM*

*UIM – Universal Interface Module. The UIM is a small footprint router protocol translator that acts as a bridge between the Tahoma platform of Multiviewers and other third party router, tally and UMD protocols. The UIM can support third-party TCP/IP, UDP as well as serial protocols. The UIM can also act as an SNMP agent for the Apantac Tahoma Multiviewers.

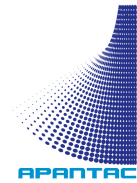

SPECIFICATIONS

SPECIFICATIONS			
Video Inputs	Up to 4 3G/HD/SD-SDI, Composite (PAL/NTSC)	Discrete AES Audio	Up to 4 channels / video input (2 pairs, balanced / unbalanced)
Connectors	BNC IEC 61169-8 Annex A	Discrete Analog Audio	Up to 4 channels / video input (2 pairs, balanced / unbalanced)
Total Windows	4 auto-detect inputs. 3G/HD/SD-SDI/CVBS. Up to 8 modules can be cascaded together to form 32 inputs	Outputs	DVI, HDMI, VGA (optional), SDI (optional)
Serial Digital	SMPTE 424M, 292M, 259M	Output Resolution	800 x 480 - 2048 x 1080 (1080p)
Equalization	120m at 2.97 Gbps, 140m at 1.48 Gbps, 400m at 270 Mbps with Belden 1694A	Built-in Extender	Up to 35 feet with passive receiver Up to 115 feet with active receiver (option) Up to 300 feet with HD Base T Extender (option) Up to 1500 feet with Fiber Optic Extender (option)
Return Loss	> 15db up to 1.485 Gbps > 10db up to 3G	On Screen Display	Skin Technology for customizing borders, labels (4/window), fonts, tally LEDs, clock faces, logos, UMD, OMD, IMD, dynamic UMD
Embedded Audio	SMPTE-272M-A	General Purpose IO	Up to 8 inputs with DB9 connectors
Composite	NTSC (SMPTE-170M), PAL (ITU 624-2)	Serial Port	RS232 with RS422 or 485 option Connector: RJ45, Baud Rate up to 115200 Format, TSL, TSI, AXP
Signal Level	1V nominal	IP	100 Base-Tx, TSL, AXP Connector: RJ45
DC Offset	0V, + - 0.1V	Electrical	25W, 90-250V 50/60 Hz - standalone 200W, 90-250V 50/60 Hz - 3RU frame
Impedence	75 ohm for BNC	EMI/RFI	Complies with FCC Part 15 Class A, CE, EU EMC, C-tick
Return Loss	40db up to 5MHz	Power	Optional redundant power supply for 1 RU. Standard redundant power supply for 3 RU
Alarms	No audio, audio high/low, no video, video black, video frozen, WSS, AFD	Size	Compact, 13.34 cm (5.25") 1RU, 44.5 cm (17.5") 3RU, 44.5 cm (17.5")
Control	Front panel buttons for quick preset recalls, GPIs, Apantac ASCII Protocol (AXP), Director (Config & control app)		

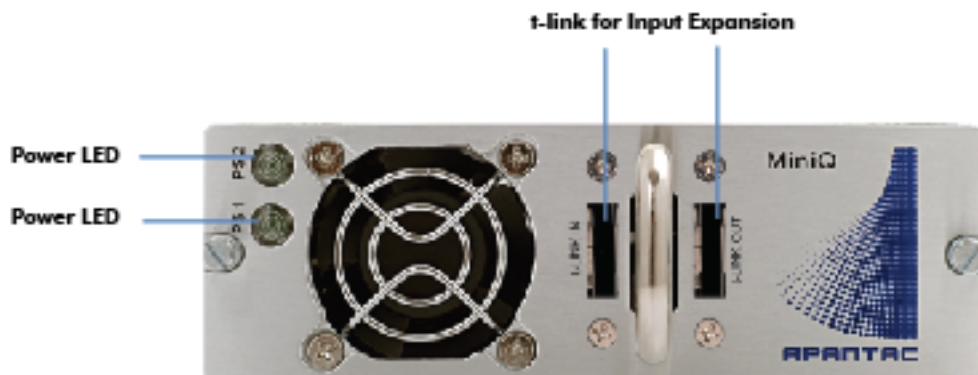

Figure 1 - show the front panel of a single MiniQ.

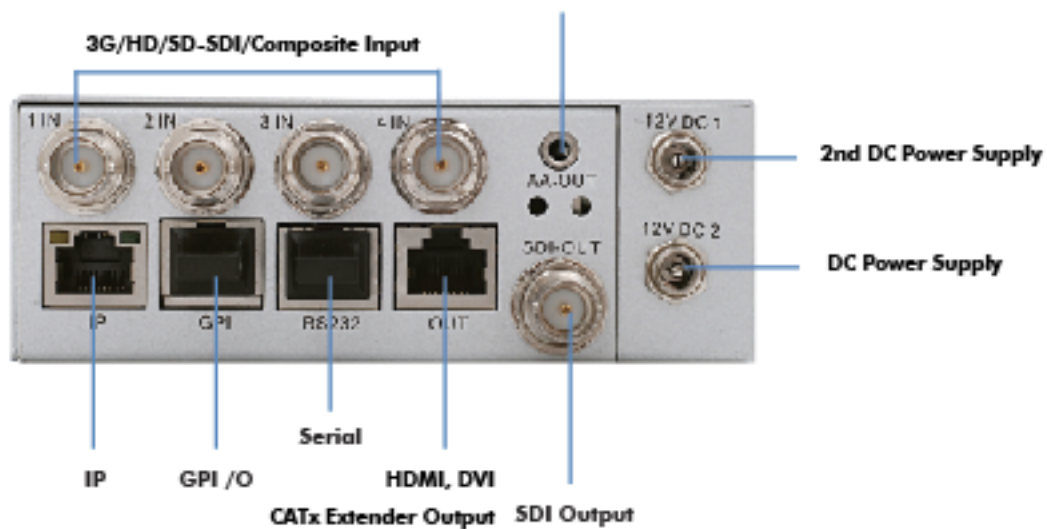

Figure 2 - show the rear panel of a single MiniQ.

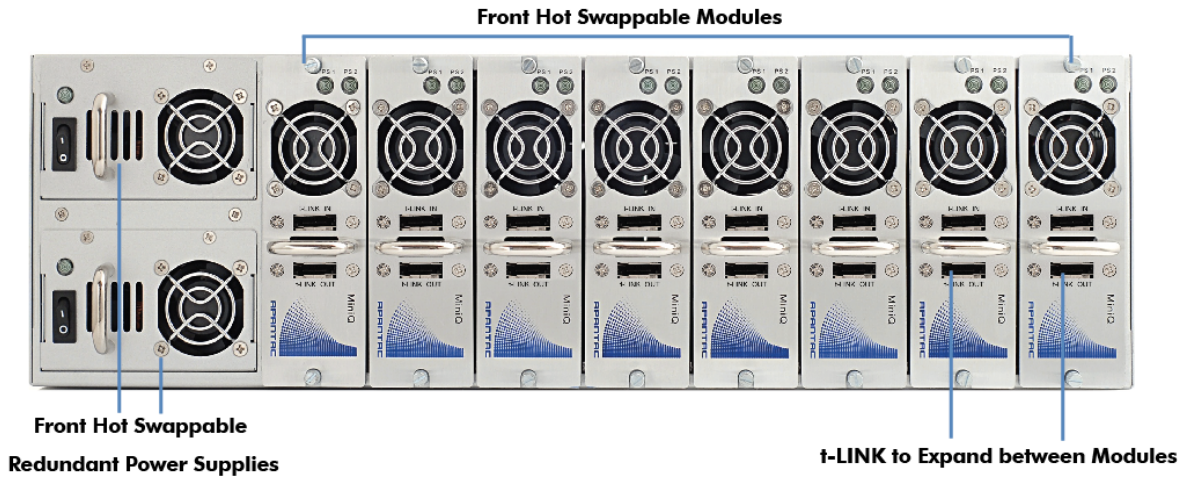

Figure 3 - show the front view of a fully configured MiniQ-3U-FR frame

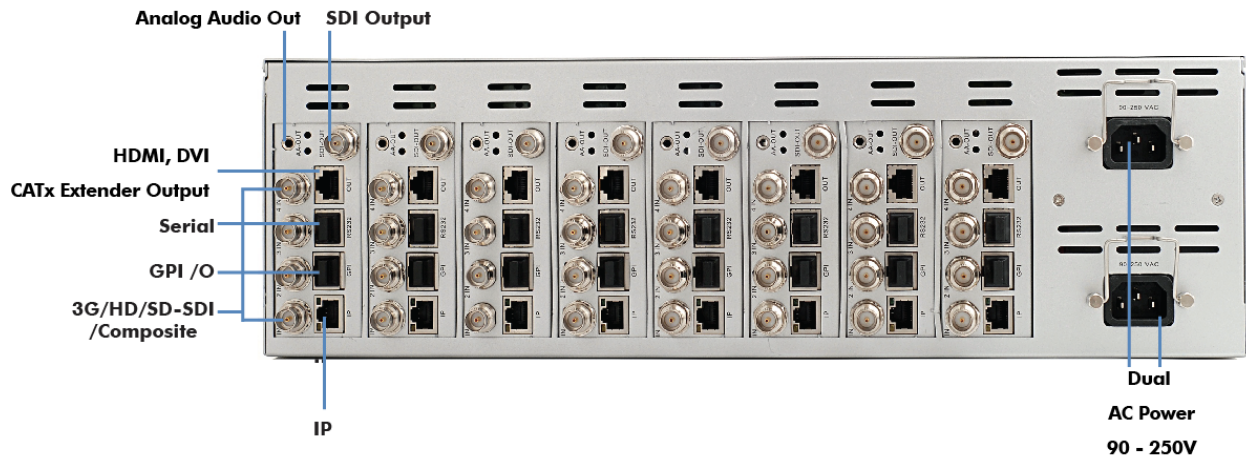
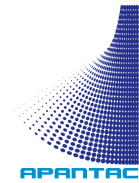

Figure 4 - show the rear view of a fully configured MiniQ-3U-FR frame



PRODUCT CONTENTS - "WHAT'S IN THE BOX"

Table-10: What's in the box – MiniQ Single

	Description	QTY
1	MiniQ Module	1
2	MiniQ Module Top cover	1
3	Serial Breakout	1
4	GPI Breakout	1
5	CD	1
6	RJ45 to HDMI cable	1
7	HDMI to DVI adapter	1
8	t-link cable for cascading	1
9	Terminal block for GPI	1
10	DC Power Supply	Optional
11	1 RU Rack Mount	Optional

Table 11: What's in the box – MiniQ mouted in MiniQ-3U-FR

	Description	QTY
1	MiniQ Modules	Up to 8
2	Serial Breakout	1 per MiniQ module
3	Rack mount	1 set of Rack Ears
4	GPI Breakout	1 per MiniQ module
5	Power Supplies	2
6	RJ45 to HDMI cable	1 per MiniQ module
7	t-link cable for cascading	1 per MiniQ module
8	HDMI to DVI adapter	1 per MiniQ module
9	Terminal block for GPI	1 per MiniQ module
10	CD	1

INSTALLATION

Mechanical Installation:

MiniQ can be installed in a standard 19" rack using the proper screws and washers (not included). Tahoma modules are shipped with rack ear. These accessories are not installed to ensure proper shipment. First locate them in the accessories box and then install them.

Note: The MiniQs airflow is from front to back.

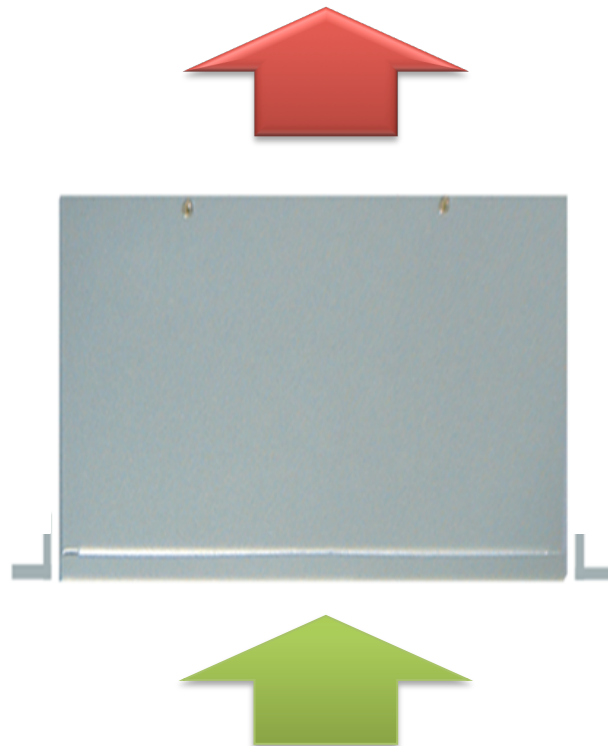

Figure 5 - Rack mount and airflow for Tahoma MiniQ

Default IP addresses

- When MiniQ is delivered as a single unit, the default IP address is set to 192.168.1.151
- When MiniQ is delivered in the 3 RU frame, the default IP address is set to 192.168.1.151 ~ 158, from right to left (facing the front)

IP Hub/Switch

Cascading between MiniQ's

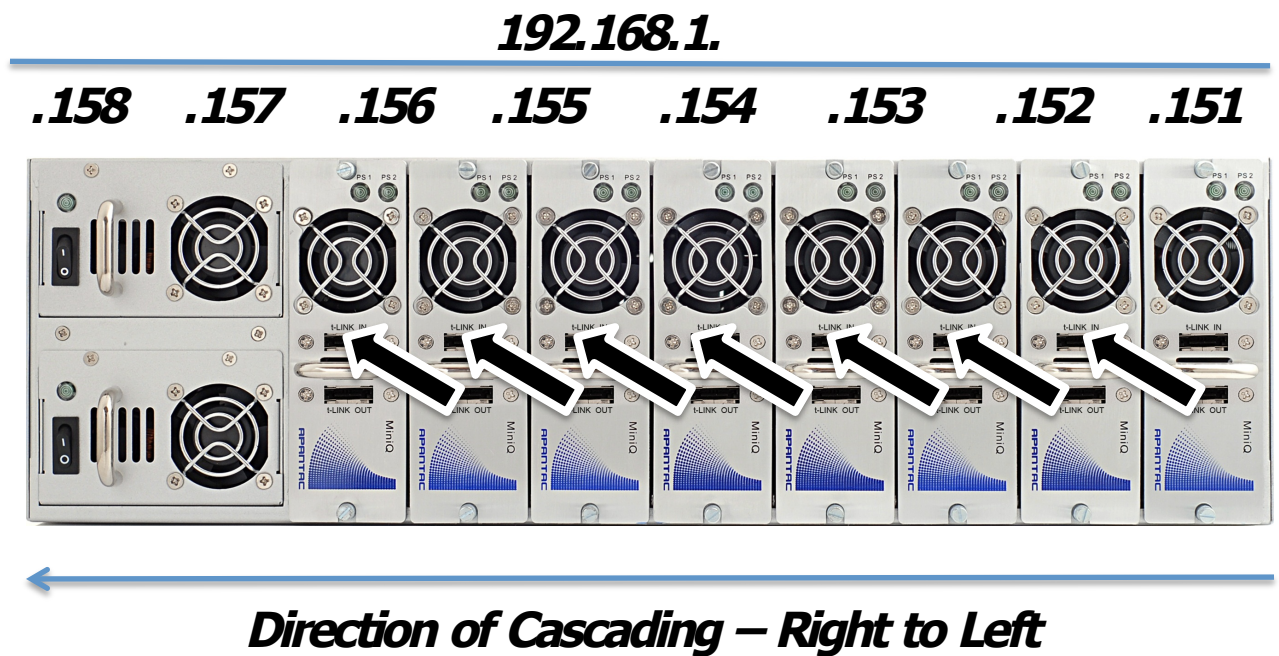
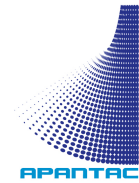

Figure 6 - Cascading and IP addresses of multiple MiniQ's in a MiniQ-3U-FR



Power Connection:

The single MiniQ has 2 DC power connectors to provide redundancy. The optional DC power supplies are Universal power supplies for 90 V to 250V operation.

The MiniQ-3U-FR has 2 hot swappable AC power supplies. They are universal power supplies for 90V to 250V operation

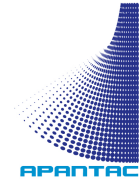

OPERATION

Powering Up

There is no power switch on the Tahoma Multiviewers. Plugging in the power cord will turn on the Multiviewer. Unplugging the power cord will turn off the Multiviewer.

Connection / Indicator / Button Descriptions

- BNC connectors for auto-detect video inputs
- 16 embedded audio meters per SDI inputs
- 8 GPI/O on the control board for alarms and recalling presets
- 8 GPI/O on the video processing board for tally, alarm and recalling presets
- 1 Ethernet connection for control and configuration
- 1 RJ45 input for serial connection
- 1 phoenix on the rear panel for line Level analog audio monitoring
- 1 RJ45 for DVI/HDMI(1.2/1.3)/VGA outputs with built in extenders to reach 35 meters (115 feet)
- LED for power status. One LED per power supply

Optional Hardware

- RJ45 to VGA Receiver
- HDMI-1-R for HDMI extension
- DVI-1-LR for DVI extension

MiniQ MULTIVIEWER SETUP EXAMPLES

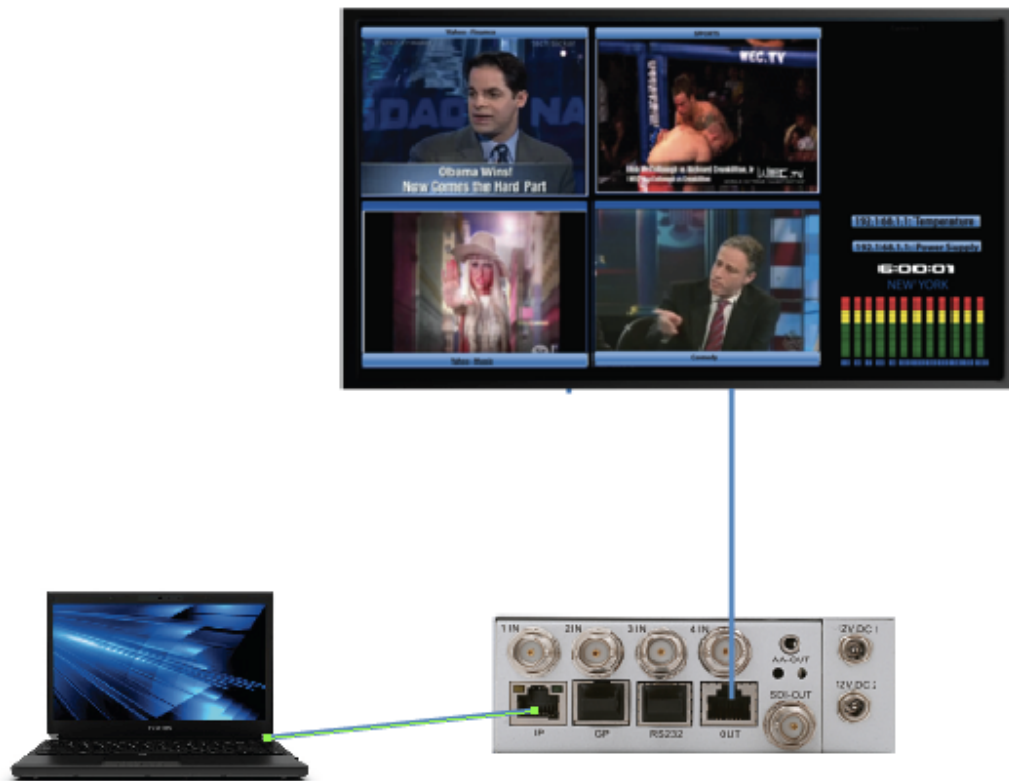

Figure 7 - Single MiniQ modules installation with Ethernet connection.

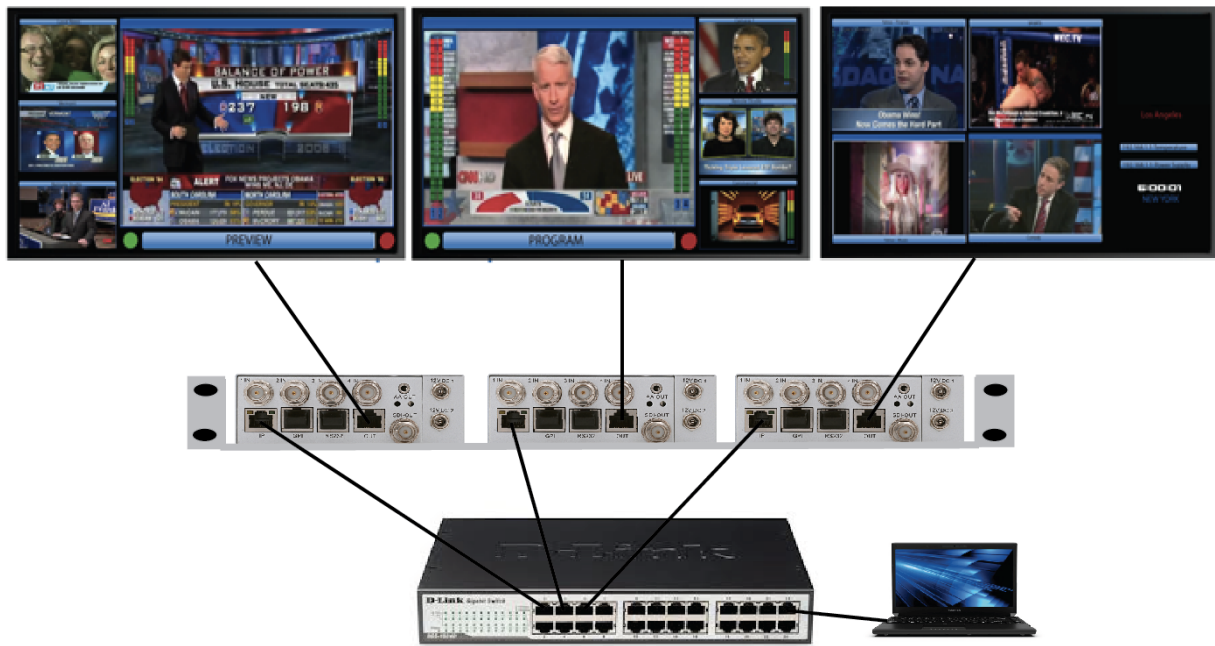

Figure 8 - Multiple MiniQ Modules installation with a MiniQ-1U-FR rackmount.

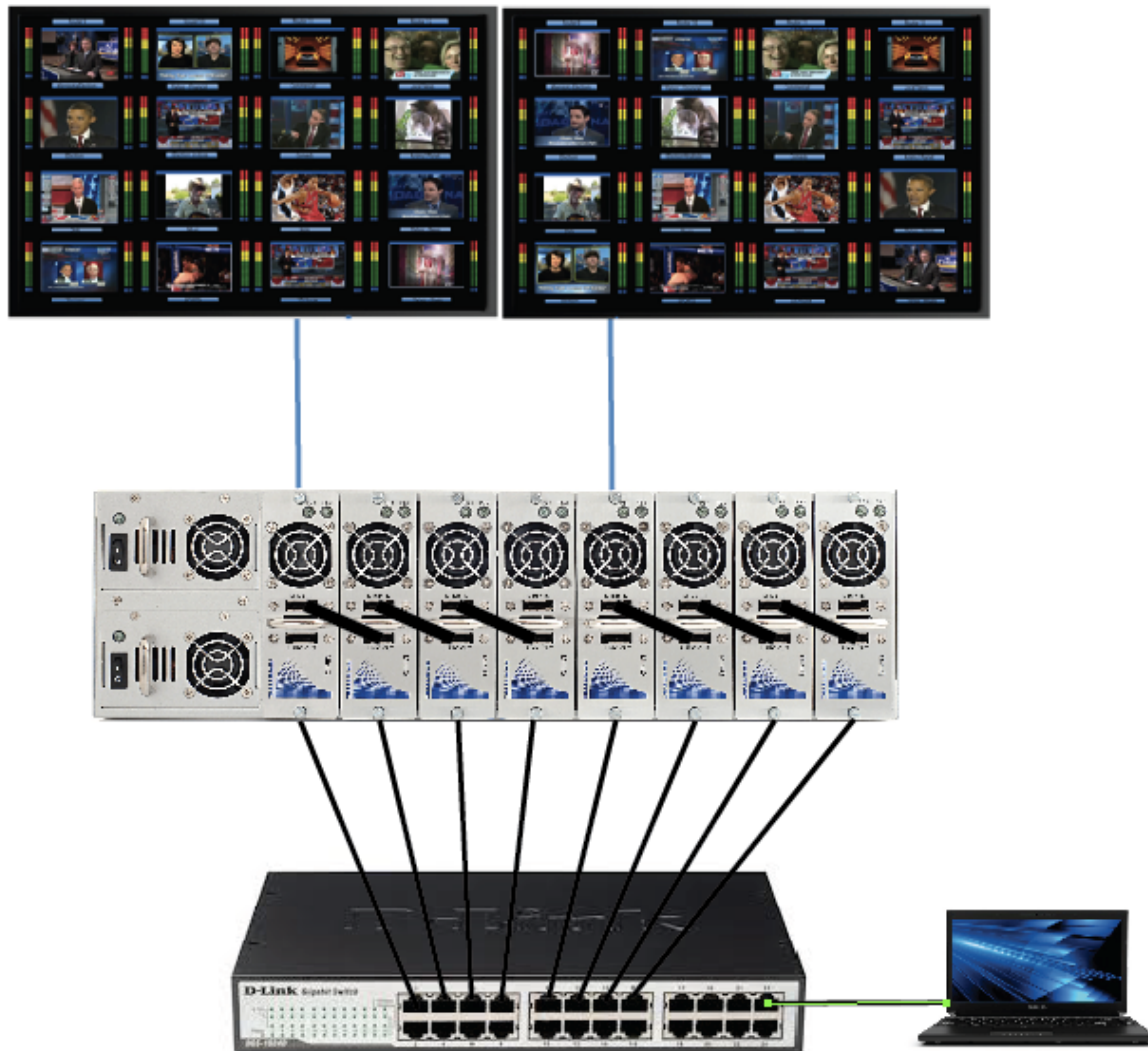

Figure 9 - A fully configured MiniQ in a MiniQ-3U-FR frame setup. Using t-Link to cascade multiple modules together to form a 2 x 16 setup

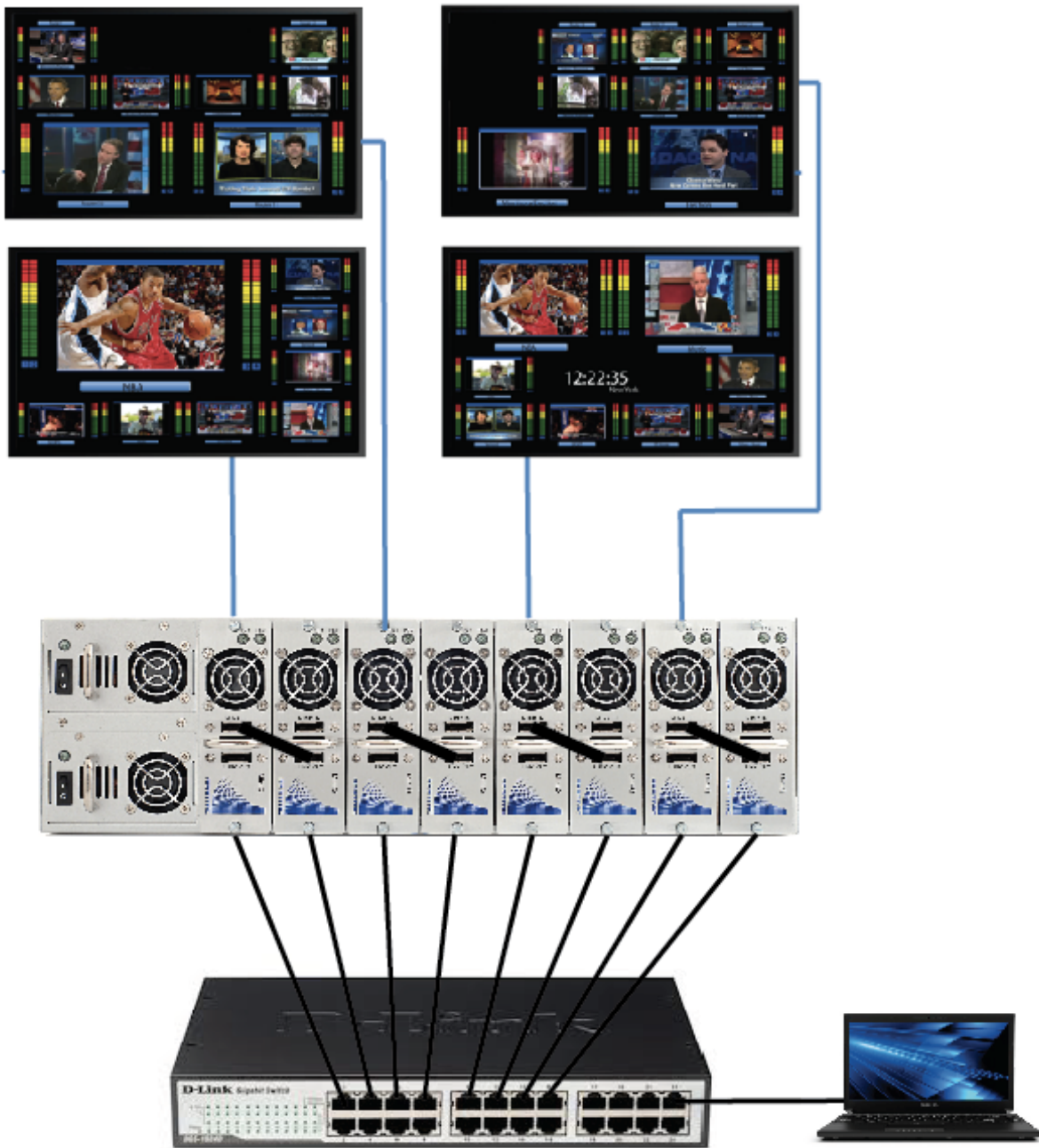

Figure 10 - A fully configured MiniQ in a MiniQ-3U-FR frame setup. Using t-Link to cascade multiple modules together to form a 4 x 8 setup

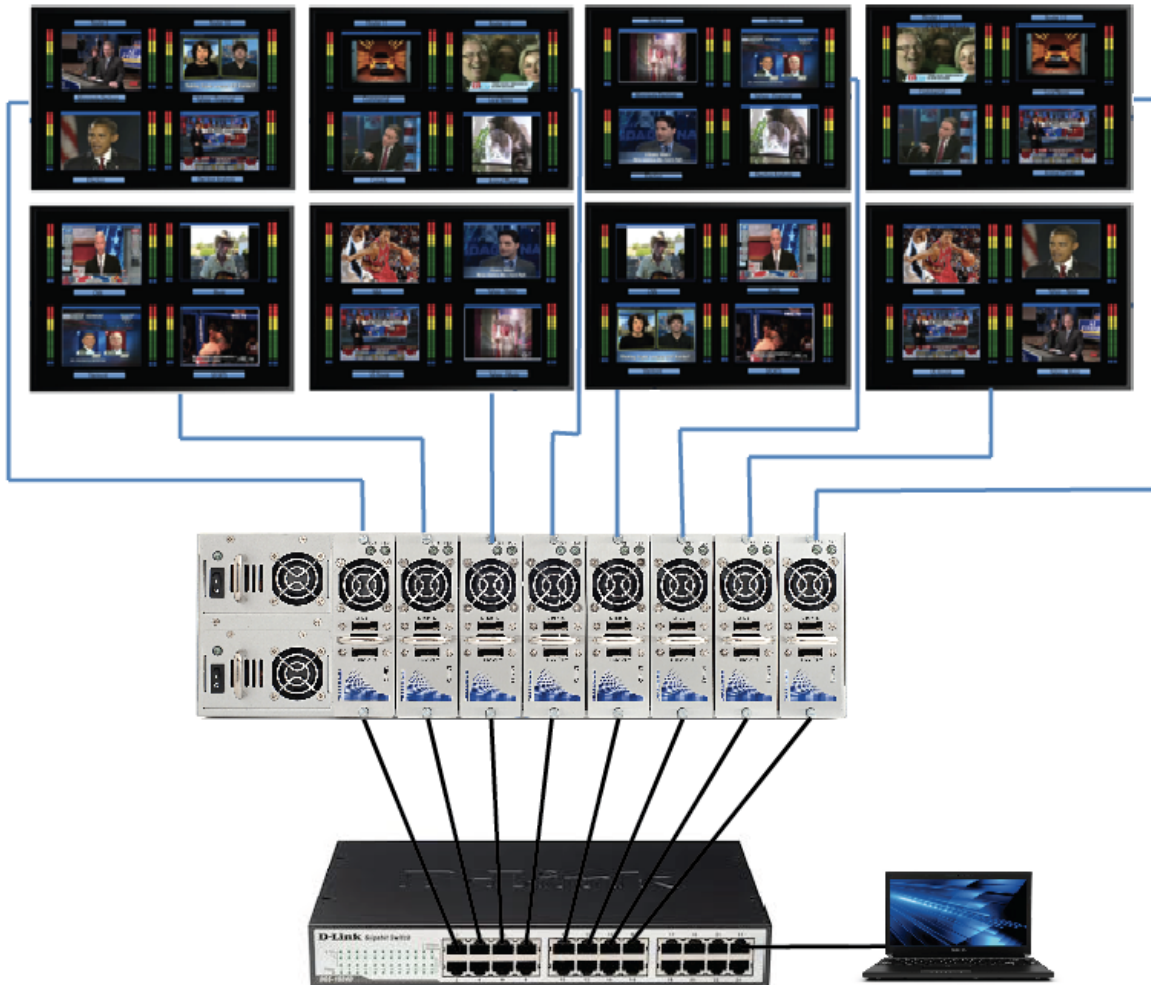
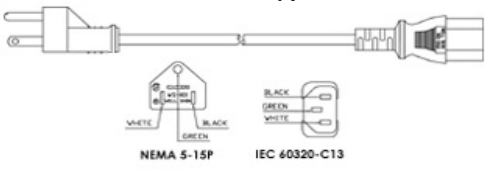



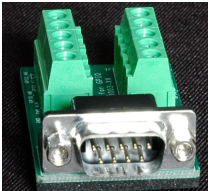



Figure 11 - A fully configured MiniQ in a MiniQ-3U-FR frame setup. Using t-Link to cascade multiple modules together to form a 8 x 14 setup

ACCESSORIES

Standard Accessories:

<p>Power cord (North American customers only)</p>  <p>NEMA 5-15P IEC 60320-C13</p>	<p>GPI breakout (on control board) – RJ45 to DB9</p> 
<p>Rack mount</p> 	<p>RJ45-DB9 converter for RS232 serial connection</p> 
<p>Terminal Block</p> 	<p>CD, manual</p> 

APPENDIX A: CONNECTORS

BNC Inputs:

- 4 X BNC Connector
- Auto Detection for SDI and CVBS signal



Figure 12 -75 ohm BNC Connector

HDMI / DVI RJ45 Output Connector:

- 3 differential pairs for data
- 1 differential pair for clock
- Total 8 pins

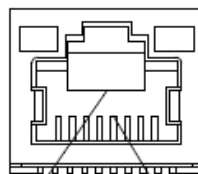

Housing Insert

Figure 13 - RJ45 connector

Pin #	1	2	3	4	5	6	7	8
Function	Clk+	Clk-	Data 2+	Data 1-	Data 1+	Data 2-	Data 0+	Data 0-

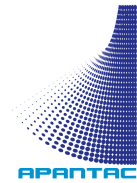

HDMI / DVI Input Connector

Pin #	1	2	3	4	5	6	7	8
Function	Clk+	Clk-	Data 2+	Data 1-	Data 1+	Data 2-	Data 0+	Data 0-

VGA RJ45 Connector:

- 3 for RGB
- 1 for HS
- 1 for VS
- Others are GND
- Total 8 pins

Pin #	1	2	3	4	5	6	7	8
Function	VS	HS	BLUE	GND	GREEN	GND	RED	GND

RS232 RJ45 Connector:

- 1 pin for Tx
- 1 pin for Rx
- 3 pins for 5V power
- 3 pins for GND

Pin #	1	2	3	4	5	6	7	8
Function	5V	GND	Tx	GND	Rx	GND	5v	5v

GPI I/O:

- RJ50 defined GPI I/O
- 8 pins GPI I/O
- 1 power alarm
- 1 GND

Pin #	1	2	3	4	5	6	7	8	9	10
Function	GPI I/O #1	GPI I/O #2	GPI I/O #3	GPI I/O #4	GPI I/O #5	GPI I/O #6	GPI I/O #7	GPI I/O #8	Power Alarm	GND

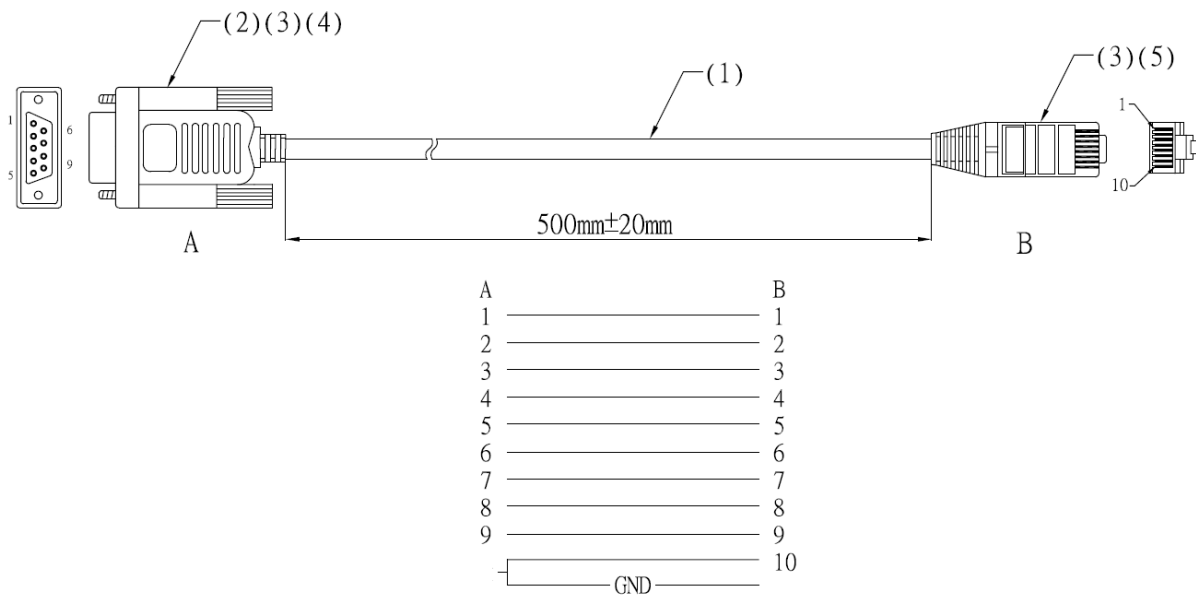

Figure 14 - RJ50 to DB9 cable

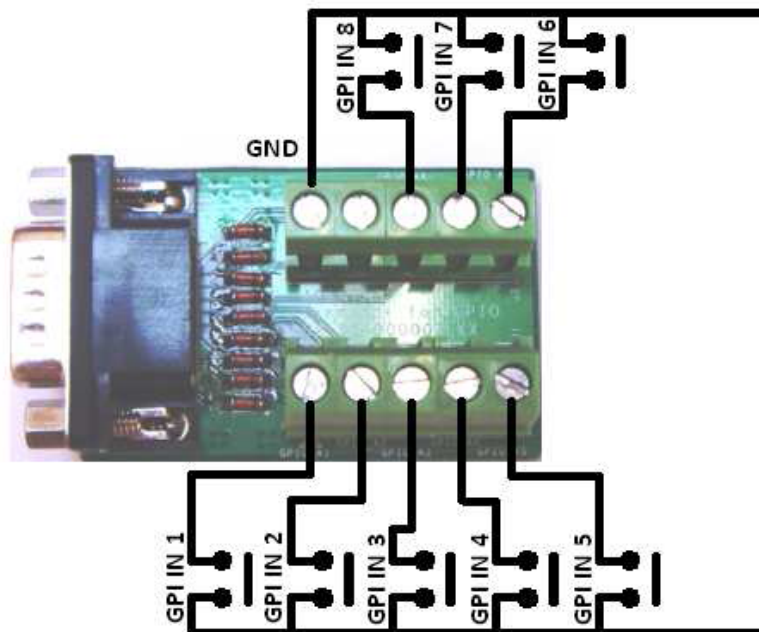

Figure 15 - GPI-IN Wiring diagram. Connect this terminal block to the RJ50 to DB9 cable shown in Figure 14.

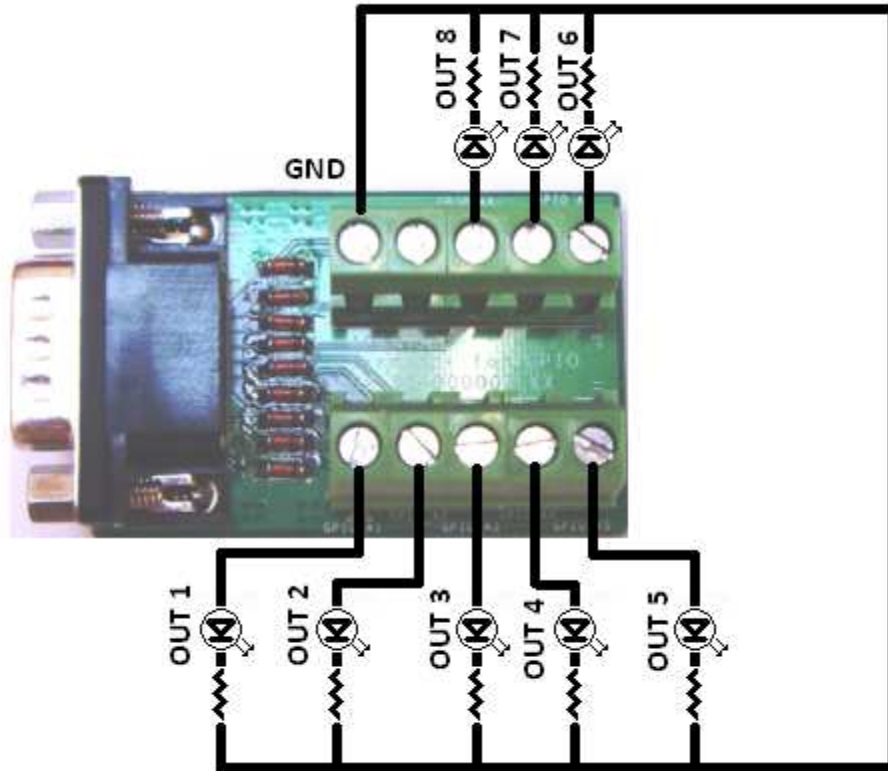
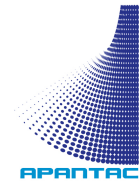

Figure 16 - GPI-OUT Wiring diagram. Connect this terminal block to the RJ50 to DB9 cable shown in Figure 33. Note: All LED are standard LEDs, all resistors are 150 ohms



APPENDIX B: External DC POWER SUPPLIES

- Input: Universal 100-240 VAC / 47-63 HZ input, without any slide switcher output: 12V / 0~5A
- Case Dimension: 120L X 60W X 38 H MM
- Efficiency: 78% is typical
- Safety: UL/CUL/GS/PSE/BSMI
- EMI: FCC/CE Class B, conduction and radiation has been met.
- High frequency design, less power consumption
- CEC law (energy efficiency) has been met
- Over voltage protection, short circuit protection

Input:

Voltage	Range: Universal 100-200 VAC, single- phase Nominal: 100-120 VAC / 200-24-VAC
Frequency	47 – 63Hz
Current	1.5A Max
Inrush Current	30A Max/100VAC; 60A Max / 240VAC
Efficiency	78% minimum 9At normal line voltage, full Load)

DC Output:

Voltage	12.00V
Current	5A MAX
Regulation	Vo+-5%
Ripple- and Noise	200 mV Max
Total Power	60 W Max

Protection:

Over Voltage Protection	V out (110% - 140%)
Short Circuit Protection	Automatic recovery after short circuit fault removed

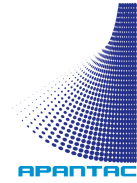

Operating and Environmental Performance:

Temperature Range

Operating	0 OC~C +40 OC
Storage	~ 20 OC~C +60 OC

Humidity Range (non-condensing)

Operating	OPERATING	20%~ 80% RH
Storage	STORAGE	10%~ 90% RH

Cooling should operate without fan
MTBF: 50000 HOURS Min: 25OC FULL LOAD

MECHANICAL

WEIGHT: 320g
 CABLX- TYPE UL 1185 18AWG
 WIRE + PLUG BLACK
 PLUG: 5.5 X 2.5 X 10 mm



Lock Ring to secure connection
 CABLX- LX-NGTH: 150 cm
 CASE DIMENSION: 120 mm(L) x 60mm(W) x 38mm(H)
 EXTERNAL LOOK:

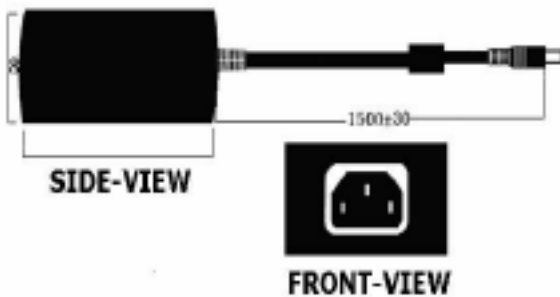

MATERIAL FLAMMABILITY: UL 94V-0

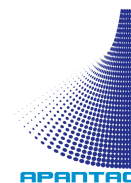

CONTACT APANTAC

For troubleshooting, support and service, as well as upgrades, please contact:

Phone: +1 503 616 3711

Email: support@apantac.com

Apantac

7556 SW Bridgeport Road

Portland, OR 97224

USA

Phone: +1 503 616 3711

Fax: +1 503 389 7921

Email: support@apantac.com

www.apantac.com