

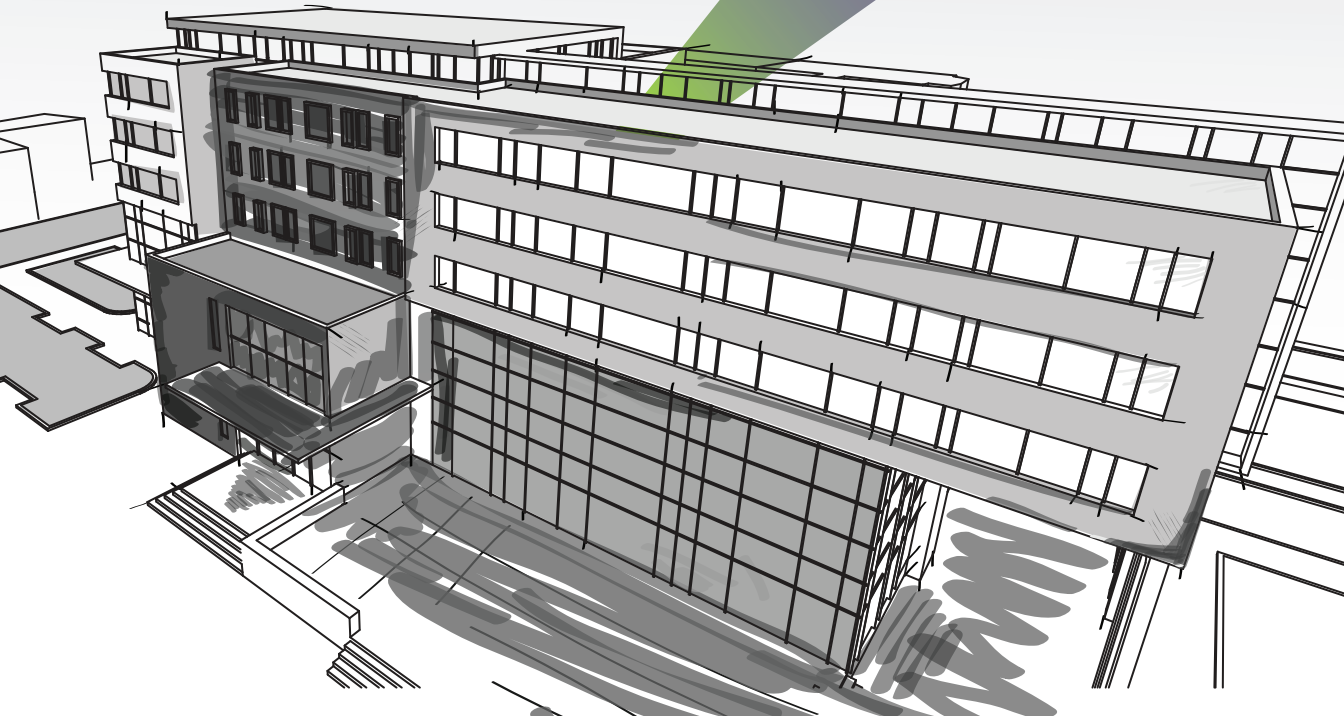

DualForceTM

2G and 3G Adjustable Dual-Band Signal Booster Kit

User Guide



Thank you for your purchase of SureCall's DualForce. The DualForce offers many of the benefits of DAS but at a fraction of the cost. DualForce was specifically designed to eliminate frustrations over dropped calls, limited range and slow data rates by amplifying incoming and outgoing cellular signals in homes and offices up to 25,000 square feet and up to 100 users. DualForce enhances 2G and 3G voice and reception data for all major U.S. carriers.

If you need any assistance while installing this product please contact tech support at 1-888-365-6283 or email us at: support@surecall.com.

How It Works	Pg. 4
Package Contents	Pg. 5-6
Installation Overview	Pg. 7
Installing Your Hardware	Pg. 7
Finding the Strongest Signal	Pg. 8
Installing the Outside Anntenna	Pg. 9-11
Installing the Inside Anntenna	Pg. 12-13
Installing Signal Booster	Pg.14
Configure Gain Setting	Pg. 15-18
Troubleshooting	Pg. 19-20
Specification	Pg. 20
Kitting Information	Pg. 21
Warranty	Pg. 22-23
Safety Information	Pg. 23

How It Works

SureCall's DualForce is a high-quality bidirectional signal booster that enhances cellular signals to areas that are prone to weak cellular coverage.

DualForce works with two or more antennas:

- Up to four inside antennas that communicate with your cell phone.
- An outside antenna that communicates with the cell tower.

Signals sent from a cell tower are received by the outside antenna, amplified by the booster and then broadcast to your phone via the inside antenna.

When your phone transmits, the signal is sent to the inside antenna, amplified and then sent to the cell tower via the outside antenna.

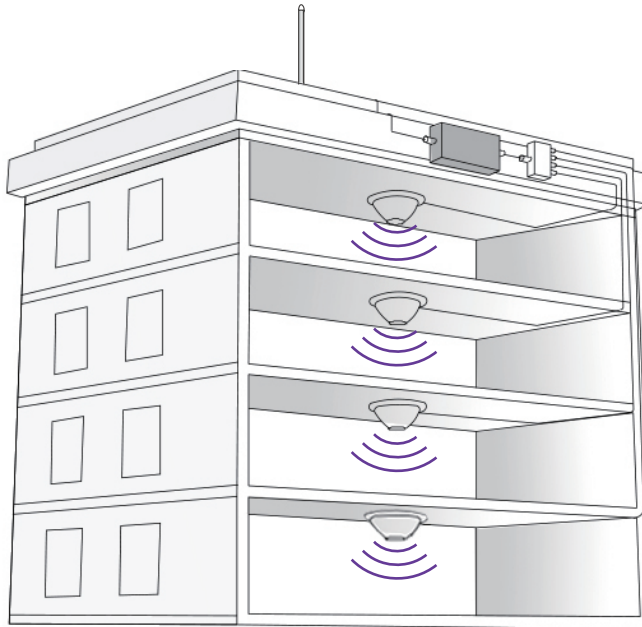

1. Unpack all package contents. For missing or damaged items, contact your reseller.

2. Turn over the signal booster and record the model and serial number for reference:

Serial #: _____

Purchase Date: _____

3. Keep the carton and packing material to store the product in case you need to return it.

Standard DualForce signal booster packages include the following items:

- One SureCall DualForce booster
- One outside antenna
- Cable for connecting the outside antenna to the signal booster
- One inside antenna
- Cable(s) for connecting the inside antenna to the signal booster
- One power supply

DualForce



SC-400 Cables



Outside Antenna (Option)

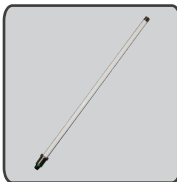

Omni



Yagi

Inside Antenna (Option)



Dome



Panel

Note: DualForce is available in four standard kits that are customized to your particular needs. Other kit options available include additional dome or panel antennas, cables and splitters. For more information see our website or email us at sales@surecall.com. Due to the recent change of our company name from Cellphone-Mate (CM) to SureCall (SC) we have changed the prefix on all of our antennas, cables and accessories from CM to SC-.





Package Contents

Installation Overview

Please determine which kit you have from the following list:

Model	Package Options
SC-DUALH/O-72-OD-Kit	1 Outdoor Omni antenna, 1 interior dome antenna, 30' and 75' SC400 coax cables
SC-DUALH/O-72-YD-Kit	1 Outdoor Yagi antenna, 1 interior dome antenna, 30' and 75' SC400 coax cables
SC-DUALH/O-72-OP-Kit	1 Outdoor Omni antenna with 1 interior panel antenna, 30' and 75' SC400 coax cables
SC-DUALH/O-72-YP-Kit	1 Outdoor Yagi antenna with 1 interior panel antenna, 30' and 75' SC400 coax cables

For a detailed description, see Kitting Information on page 20.

	Antenna Type	Model No.	Usage Coverage
	Omni Outdoor Antenna	SC-100-L	Omni Antennas are ideal for topographies with minimal obstacles. They offer 360° hemispherical coverage
	Yagi Outdoor Antenna	SC-230W-S	Yagi antennas are for targeted areas and capable of reaching cell towers up to 30 miles away
	Dome Antenna	SC-222W	Dome antennas are for a central location with 360° coverage
	Panel Antenna	SC-248W	Panel Antennas allow optimum reception to targeted areas

Warning: Unauthorized antennas, cables, and/or coupling devices are prohibited by FCC new rules. Please contact FCC for details: 1-888-CALL-FCC. Changes or modifications not expressly approved by SureCall could void the user's authority to operate the equipment.

Note: Due to the recent change of our company name from Cellphone-Mate (CM) to SureCall (SC) we have changed the prefix on all of our antennas, cables and accessories from CM to SC-.

- Step 1. Make sure you have positioned the booster close enough to an existing electrical outlet.
- Step 2. Make sure you have sufficient cable length between proposed outside antenna location and booster connector.
- Step 3. Make sure you have sufficient cable length between proposed inside antenna location and booster connector.

Installation Overview

- Step 1. Find the outside area that has the strongest signal. (See page 8 for instruction if needed)
- Step 2. Install the outside antenna in the area identified in step 1. (See page 9-10 for instruction if needed)
- Step 3. Install the inside antenna. (See page 11-12 for instruction if needed)
- Step 4. Mount the signal booster, connect the outside and inside antenna cables to the signal booster, and connect the booster to an AC power source. (See page 13-14 for instruction if needed)
- Step 5. Configure gain settings on the signal booster if needed. (See page 14 for instruction if needed)

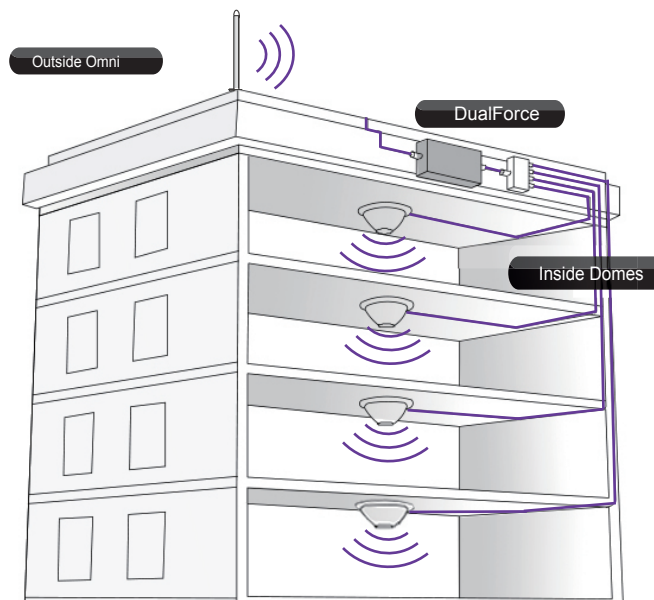

Step 1. Find the area with the Strongest Signal

The signal booster requires a minimum cellular signal of low -100 dBm to high -90 dBm. If your DualForce kit includes an outside omni antenna and you can only achieve cell phone reception of one bar or less, you may need a DualForce Yagi antenna which is capable of targeting carrier antenna towers that are up to 30 miles away. Call or email SureCall for assistance.

Signal readings usually appear as a negative number (for example, -85). The stronger the signal, the closer it gets to zero (see the graph below). Before installing the outside antenna, find the area with the strongest cellular signal source from your service provider by following the directions below. You can also go to www.antennasearch.com to find the general location of your carrier's towers.

Measure the strength of the existing cellular signal in various locations.

- Apple iPhones: Dial *3001#12345#* and press Call. In the top-left corner, a number appears instead of bars.
- Android devices: download apps such as "Network Signal Info" in the Google Play store to measure signal strength. Search check real signal strength to find other cell signal measurement apps.
- Internet: Go to www.speedtest.net

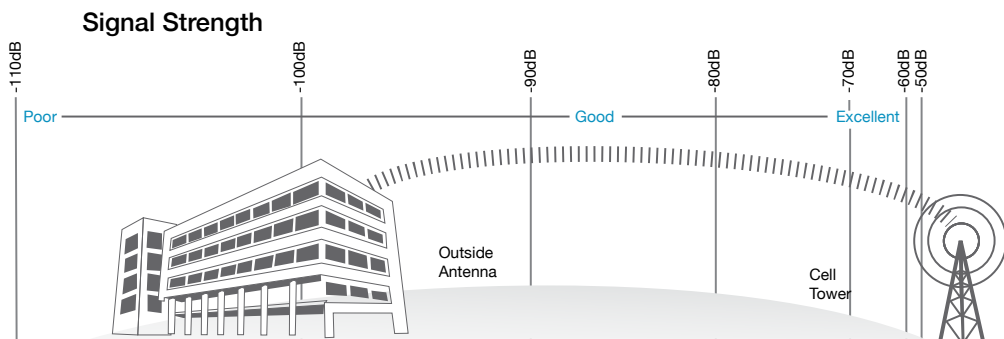

2. Select a location away from buildings, walls, trees, hills, and other terrain features that can block or reflect wireless signals (12-inch clear radius is recommended).

Note: Where you install your outside antenna in relation to the carrier's cell phone tower also determines signal strength. Although cell phone carriers try to place towers for maximum coverage, local ordinances and terrain features can restrict tower locations, which can limit signal strength at your location.

Step 2. Install the Outside Antenna

1. Outside Omni antennas receive and send signals in a 360° radius. Yagi or directional antennas work best when pointed in the direction of your cell phone carrier's cell tower. Mount the outside antenna as high as possible. If you are installing a Yagi antenna set it up facing the cell tower in the area where you located the best signal source (see step 1 on the previous page).
2. Make sure that the mounting area has at least a 12" radius clear of obstructions and other radiating elements.
3. If the mounting area is prone to weak cellular signals or if the density of the roof and ceiling partially block the signal, the booster will operate at its default setting of 65 dB gain, be sure to place the outside antenna at least 75 feet from the inside antenna for best performance.
4. Do not co-locate antennas or operate the outside antenna with any other antenna or signal boosters.
5. Run the SC-400 cable from the outside antenna to the signal booster. Hand tighten the connection

Note: See next page for outside antenna installation details.

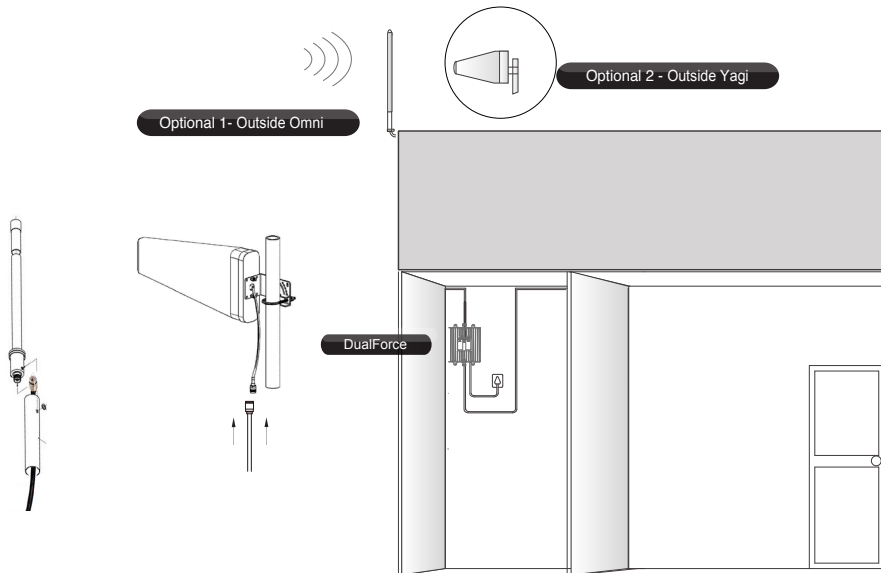

Installing Your Hardware

DualForce's omni antenna comes with equipment for mounting on a vertical wall. For best results the antenna should be mounted in an upright position.

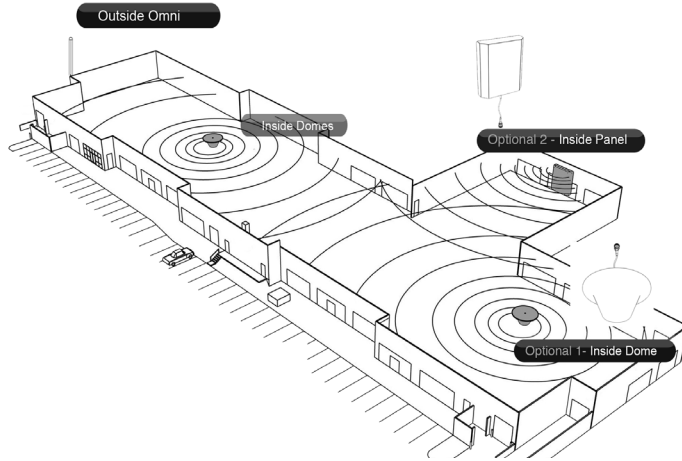

Step 1: Slide both mounting brackets over the mounting sleeve leaving them loose.

Step 2: Remove the plastic thread protector cap from the bottom of the antenna.

Step 3: Slide the coax cable (not included) through the mounting sleeve (with mounting brackets) and snugly hand tighten the coax cable connector onto the threads at the bottom of the antenna.

Step 4: Slip the mounting sleeve over the base of the antenna. Align the hole in the mounting sleeve with the screw hole in the antenna and fasten the two together using a small machine screw and washer.

Step 5: Space the mounting brackets as wide apart as possible on the mounting sleeve and after ensuring that both brackets are facing the same direction, tighten the brackets using these screws.

Step 6: Two Options

(Option one, pole mounting): Mount the entire assembly to a 1 to 2 inch diameter pole (not included) by placing the U bolts around the pole and tightening them through the holes in the mounting brackets using the nuts and washers. The antenna should be mounted with the chrome tip pointing toward the sky (perpendicular to the ground). For best results, the white fiberglass portion of the antenna should be mounted above the roofline and unobstructed in all directions.

(Option two, flat vertical surface mounting): The antenna can be mounted to a flat vertical surface by replacing the U bolts with wood or metal screws (not included). For best results, the white fiberglass portion of the antenna should be mounted above the roofline and unobstructed in all directions. Secure the screws through the mounting brackets directly into the flat vertical mounting surface ensuring that the chrome antenna tip is pointed towards the sky (perpendicular to the ground).

Note: The small hex wrench included in the package is only used if the cable connector at the base of the antenna becomes loosened during shipment. Although rare, if this occurs remove the small round green sticker located at the base of the antenna and tighten the hex screw using the included wrench until the connector is secure. Do not over tighten.

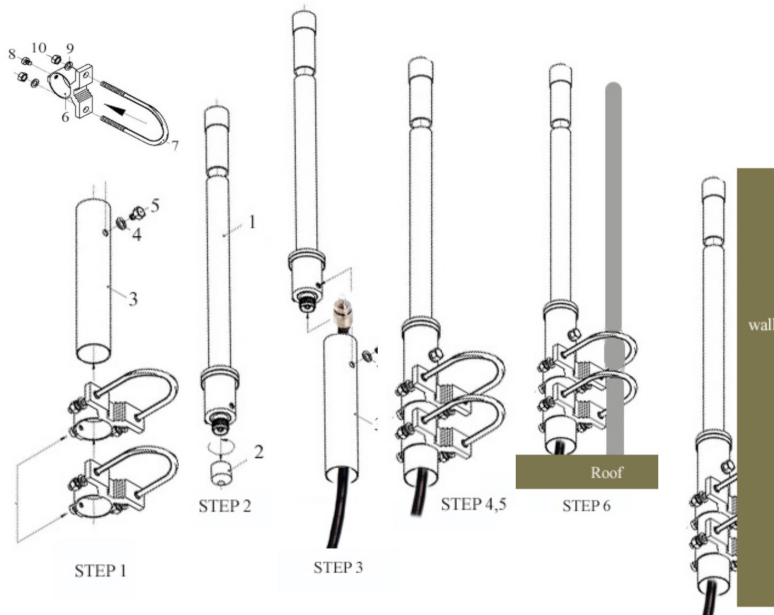

Installing Your Hardware

Step 3. Install the Inside Antenna

Inside antennas come in omni-directional (dome) and flat panel versions.

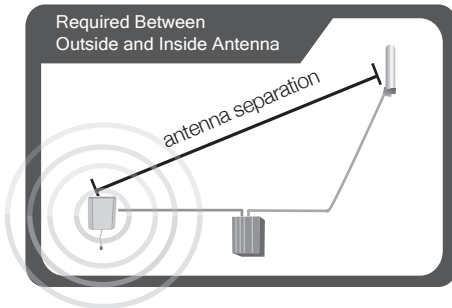

Antenna Separation Table

Amplifier gain	Min. separation (ad)
40dB	5-6'
45dB	15-20'
50dB	50'
55dB	60'
65dB	75-80'
72dB	100'-110'

Note: As you can see from the table above, acquiring the recommended inside and outside antenna separation optimizes coverage significantly. Any reduced antenna separation reduces the booster's coverage.

1. If your inside antenna is a dome type, mount it on the ceiling in a central location.
2. If your inside antenna is a flat panel, install it against a wall or surface projecting the area where you want reception. Point the antenna away from the outside antenna. To avoid interference stay a minimum distance of 3 feet from the panel antenna.

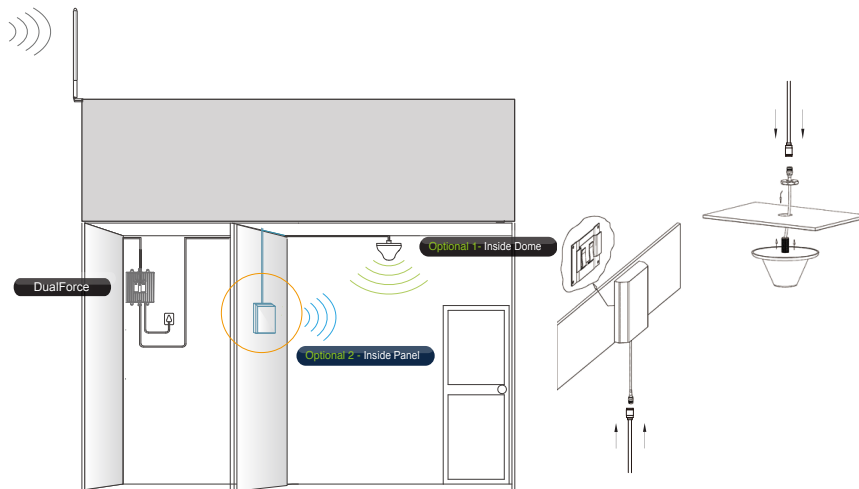

Note: see next page for outside antenna installation details.

The SC-222W multi-band plastic antenna is an omni-directional interior antenna that gathers signals from all sides. Range of antenna is dependent on three factors: 1) physical obstructions, 2) power generated by booster and 3) reception from outside signal received and distributed by outside antenna.

Besides the antenna itself, parts include mounting equipment for either a flat horizontal surface or a wall. It should be mounted in an upright position for best results.

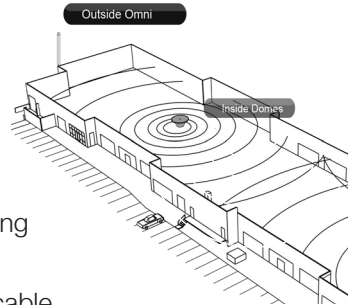

Step 1: Drill a 35mm diameter hole in the ceiling. The ceiling thickness should be 20mm, maximum.

Step 2: Unscrew fixing nut from antenna. Place antenna cable through hole. Screw the fixing nut back onto antenna and cable on crawl space side of ceiling and fasten.

Step 3: Attach the N-Female connection from the interior antenna to the cable leading to the connector labeled INSIDE, on your booster.

Step 4: Tighten fixing nut to secure antenna (do not over-tighten).

- Storage and transportation: Store and place in non-extreme room-temperature and dry environment
- Attention: This antenna should not be used near open fire or flame

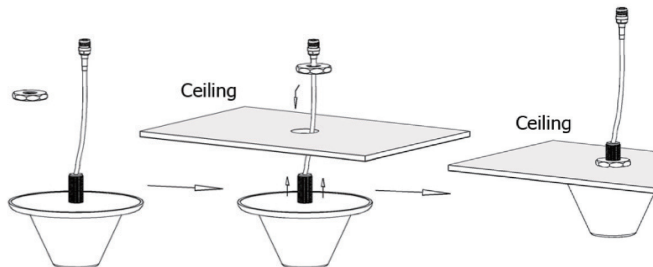

Step 4. Install the Signal Booster

1. Select a location for your booster close to a working AC outlet. Do not expose the signal booster to excessive heat, direct sunlight, moisture, and airtight enclosures.
2. Attach the supplied mounting kit to the booster using the supplied screws. Tighten the screws with a screwdriver until snug, then add a 1/4-to-1/2 turn. Do not over tighten.
3. Orient the signal booster so the LEDs and DIP switches face away from the wall and the LEDs are seen easily. Then mount the signal booster to the wall using appropriate screws and/or wall anchors.
4. Connect the outside antenna cable to the signal booster connector marked **OUTSIDE**. Hand tighten the connection.
5. Connect the inside antenna cable to signal booster marked **INSIDE**. Hand-tighten the connection.
6. Connect the AC power cord to the signal booster.
7. Connect the plug on the other end of the 110V AC power outlet.
8. Turn the booster's power switch on.
 - The signal booster turns on automatically.
 - The **Power** LED lights up to show that the signal booster is ready for use.
 - The **Alert** LEDs flash up to 15 seconds on each band to show the band is activated.

Note: If the Power LED does not turn ON or the Alert LEDs continue to flash, see Troubleshooting page 19.

This booster is rated for 5-15V input voltage. DO NOT use the booster with a higher voltage power supply. This can damage the booster, cause personal injury, and void your warranty.

Booster Hardware

The following image shows the key hardware components on the cellular booster. Refer to this image as you install your DualForce kit components.

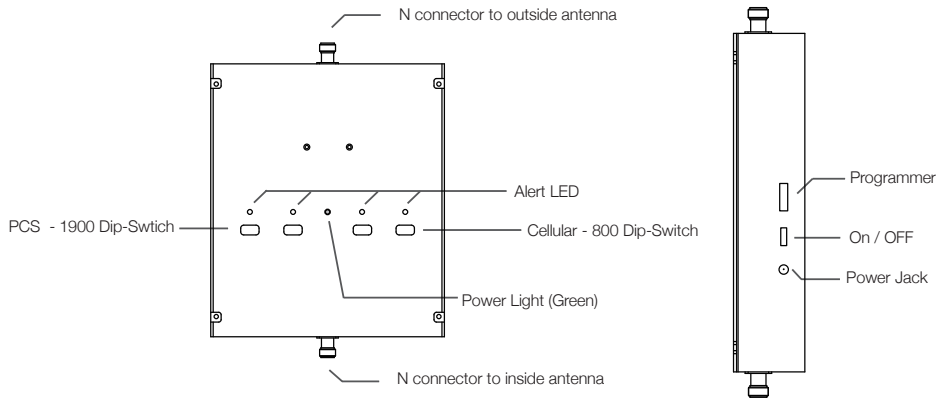

DIP Switches and Lights

The DualForce Industrial booster has the following indicators and controls:

- PCS Uplink Warning light/DIP switches (1): These DIP switches control the PCS communications with the cellular tower.
- PCS Downlink Warning light/DIP switches (2): These DIP switches control the PCS amplification within the building.
- Power light (3): This light should be illuminated or blinking green at all times while the booster is powered on.
- Cellular Downlink Warning light/DIP switches (4): These DIP switches control the cellular amplification within the building.
- Cellular Uplink Warning light/DIP switches (5): These switches control the cellular communications with the tower.

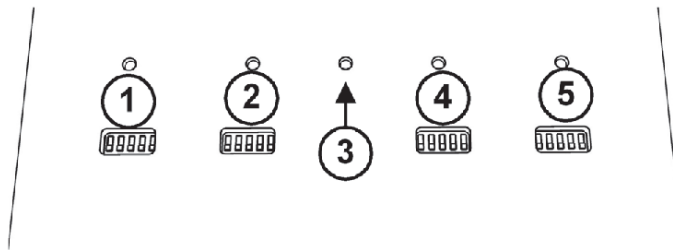

Step 5. Configure Gain Settings

Facing the front of your booster, find 4 banks of Dual In-line Package (DIP) switches. These switches allow manual dB gain attenuation for uplink and downlink channels.

- Bank 1 controls PCS communications with the cellular tower.
- Bank 2 controls PCS amplification in the building.
- Bank 3 controls cellular amplification in the building.
- Bank 4 controls cellular amplification with the tower.

The DIP switches in each bank correspond to the following dB gain values:

Switch 1	Switch 2	Switch 3	Switch 4	Switch 5
1 dB	2 dB	4 dB	8 dB	16 dB

For maximum gain on all channels, your booster ships with all DIP switches turned ON. This setting should always be your starting point when installing or reinstalling the booster. To change it, move the DIP switches to the ON or OFF position.

- Moving a switch down (away from the LEDs) turns OFF the switch and increases booster gain for the selected channel.
- Moving a switch up (toward the LEDs) turns ON the switch and decreases booster gain for the selected channel.

Switch settings are cumulative. This means the total amount of attenuation for a channel equals the combined dB of all DIP switches in the same bank being set to ON.

To Achieve attenuation	Set the DIP Switchs in the Same Bank as Follows...				
	SW1 (1 dB)	SW2 (2 dB)	SW3 (4 dB)	SW4 (8 dB)	SW5 (16 dB)
0 DB	OFF	OFF	OFF	OFF	OFF
1 DB	ON	OFF	OFF	OFF	OFF

To Achieve attenuation	Set the DIP Switches in the Same Bank as Follows...				
	SW1 (1 dB)	SW2 (2 dB)	SW3 (4 dB)	SW4 (8 dB)	SW5 (16 dB)
3 DB	ON	ON	OFF	OFF	OFF
7 DB	ON	ON	ON	OFF	OFF
15 DB	ON	ON	ON	ON	OFF
21 DB	ON	OFF	ON	OFF	ON
31 DB	ON	ON	ON	ON	ON

Note: As you see from the table above, attaining the recommended indoor and outdoor antenna separation optimizes coverage significantly. Any reduced antenna separation decreases the booster's cellular signal capabilities.

LEDs

A light-emitting diode (LED) appears above each DIP switch bank on the top panel of the signal booster.

LED	Designation	Description
LED #1	PCS Uplink	OFF = normal operation. ON = PCS uplink warning. Power off booster immediately.
LED #2	PCS Down link	OFF = normal operation. ON = PCS downlink warning. Power off booster immediately.
LED #3	Power	Green ON or blink = booster is receiving power. OFF = booster is not receiving power. Red ON = oscillation has occurred for longer than 15 minutes and the booster is shutting down (see Automatic Shutdown on page 14).
LED #4	Cellular Downlink	OFF = normal operation. ON = cellular downlink warning. Power off booster immediately.
LED #5	Cellular Uplink	OFF = normal operation. ON = cellular uplink warning. Power off booster immediately.

Automatic Shutdown

SureCall boosters that have automatic shutdown work in the following way:

1. The cellular side (LEDs 4 and 5) is usually the first side to experience oscillation. When oscillation is detected in the uplink and/or downlink, the appropriate red **Warning** LEDs flash and **Power** (LED 3) turns red.
2. If oscillation occurs on the PCS side, LEDs 1 and/or 2 blink as appropriate and **Power** (LED 3) turns red due to oscillation.
3. If the problem is not resolved, the affected side shuts down after 30 seconds. In general, the cellular side oscillates more easily than the PCS side.
4. The booster wakes up and **Power** (LED 3) turns green. If oscillation resumes, the LEDs flash as described previously. These 30-second cycles continue for 15 minutes or until the problem is resolved.
5. If the problem is not resolved within 15 minutes, the booster shuts down automatically (all LEDs OFF except **Power**, which is red) and must be reset by unplugging the booster from the power supply and plugging it back in.
6. To resolve oscillation, increase antenna separation and/or the attenuation.

If you Want to Improve Coverage

- Find a location that receives a stronger signal and relocate the outside antenna to that location.
- Increase the distance between the outside and inside antennas.

Be sure your signal booster's dB gain is turned up to maximum gain on each dial (see page 15).

In the event you encounter a problem, follow the suggestions below to resolve the issue.

Problem	Resolution
Signal booster has no power	<p>Verify that the booster switch is turned on.</p> <p>Connect the power supply to an alternate power source. Be sure the AC outlet is working and is not controlled by a wall switch that can cut power to the outlet. If the green POWER LED on the signal booster is OFF, return the power supply to SureCall. Contact tech support at 1-888-365-6283 or support@surecall.com, or go to www.surecall.com and log on to online support to receive a Return Merchandise Authorization (RMA).</p>
After installing your signal booster system, you have no signal or reception.	<p>Check the strength of the outside signal as close as you can to the outside antenna (see instructions on page XX).</p> <p>Double-check all signal booster and antenna cable connections.</p> <p>Be sure your signal booster's dB gain is turned up to full power on each dial (see page XX).</p>
One of the red LEDs next to the dials on your signal booster is flashing red.	<p>Turn down the dB gain on the dial until the light goes OFF or turns yellow.</p> <p>Be sure the inside panel antenna is facing away from the outside antenna.</p> <p>Use the recommended antenna separation:</p> <ul style="list-style-type: none"> • 65dB: 75 - 80 ft. separation • 63dB: 65 - 75 ft. separation • 55dB: 60 ft. separation • 50dB: 50 ft. separation • 45dB: 15 -20 ft. separation • 40dB: 5 - 6 ft. separation
Your signal booster restarted and shut down for 15 minutes, and is now shut down permanently.	<p>Each SureCall signal booster is equipped with Auto Shutdown to prevent cell tower interference. The outside antenna may be close to a cell tower. Move the outside antenna to a location that provides sufficient distance from the cell tower to prevent the signal booster from automatically enabling Auto Shutdown. Once away from the original location, perform the procedure on page XX.</p>
The red LED goes ON.	<p>More antenna separation is needed. If you cannot provide more antenna separation and the Alert LEDs flash after the initial activation period, lower the dial above the blinking LED by 5dB (for example, from 50 to 45) and monitor the bars on your cell phone to see whether reception improves.</p>
The Power LED does not turn ON	<p>Be sure the AC outlet is working and is not controlled by a wall switch that can cut power to the outlet.</p>

Specifications

Problem	Resolution
The Alert LEDs flash after the initial activation period.	Lower the dial above the blinking LED by 5dB (for example, from 65 to 60) and monitor the bars on your cell phone to see whether reception has improved.
The Alert LEDs continue to flash	The signal booster shuts down automatically, and then restarts after 60 seconds. Turn down the Cellular, PCS or LTE/AWS dial that is oscillating dial that is to prevent the signal booster from shutting down automatically.
Your signal booster has no power.	Verify that the switch on the power supply is turned on and red LED is ON. Connect the power supply to an alternate power source. Be sure the power source is not controlled by a switch that can remove power from the outlet. Check the green POWER LED on the signal booster. If it is OFF, return the power supply to SureCall. Contact tech support at 1-888-365-6283 or support@surecall.com , or go to www.surecall.com and log on to online support to receive an RMA.

Product Name	DualForce
Uplink Frequency Range (MHz):	Cellular: 824-849 MHz PCS: 1850-1915 MHz
Downlink Frequency Range (MHz):	Cellular: 869-894 MHz PCS: 1930-1995MHz
Input Impedance:	50 Ω
Maximum Gain:	65dB-Cellular / 72dB- PCS
Noise Figure:	5 dB
VSWR:	≤2.0
Supported Standards:	CDMA, WCDMA, GSM, EDGE, HSPA+, EVDO, LTE and all cellular standards
AC Input:	Input AC110V, 60 Hz; Output: DC 9-20V
Maximum Output Power:	1 Watt EIRP
Cable:	SC-400
RF Connectors:	N Female (both ends)
Power Consumption:	<40W
Operation Temperature:	-4°F to +158°F
Dimensions:	10.05" x 7.5" x 2"
Weight:	8.05 lbs
FCC (USA):	RSNDUALFORCE

Kitting Information

Component	Product Number	Gain / Loss	
		Cellular 800 MHz	PCS1900 MHz
Outside Antennas*	SC-100-L	8 dBi	9 dBi
	SC-230W	10 dBi	10 dBi
Outside Cable	SC-400-75NN (75 Feet)	-4.41dB	-6.17dB
Inside Antenna*	SC-248W	7 dBi	10 dBi
	SC-222W	3 dBi	6 dBi
Inside Cable	SC-400-30NN (30 Feet)	-1.97 dB	-2.67 dB

*All equivalent antennas and cables are suitable for use with the DualForce booster.

Note: Due to the recent change of our company name from Cellphone-Mate (CM) to SureCall (SC) we have changed the prefix on all of our antennas, cables and accessories from CM to SC-.

Three-Year Product Warranty

SureCall warrants its products for three years from the date of purchase against defects in workmanship and/or materials. Specifications are subject to change. The three-year warranty only applies to products meeting the latest FCC Certification Guidelines stated on 2/20/2013 and going into effect April 30, 2014. A two-year warranty applies to any products manufactured before May 1, 2014.

Products returned by customers must be in their original, un-modified condition, shipped in the original or protective packaging with proof-of-purchase documentation enclosed, and a Return Merchandise Authorization (RMA) number printed clearly on the outside of the shipping container.

Buyers may obtain an RMA number for warranty returns by calling the SureCall Return Department toll-free at 1-888-365-6283. Any returns received by SureCall without an RMA number clearly printed on the outside of the shipping container will be returned to sender. In order to receive full credit for signal boosters, all accessories originally included in the signal booster box must be returned with the signal booster. (The Buyer does not need to include accessories sold in addition to the signal booster, such as antennas or cables.)

This warranty does not apply to any product determined by SureCall to have been subjected to misuse, abuse, neglect, or mishandling that alters or damages the product's physical or electronic properties.

SureCall warrants to the Buyer that each of its products, when shipped, will be free from defects in material and workmanship, and will perform in full accordance with applicable specifications. The limit of liability under this warranty is, at SureCall's option, to repair or replace any product or part thereof which was purchased up to **THREE YEARS after May 1, 2014 or TWO YEARS for products purchased before May 1, 2014**, as determined by examination by SureCall, prove defective in material and/or workmanship. Warranty returns must first be authorized in writing by SureCall. Disassembly of any SureCall product by anyone other than an authorized representative of SureCall voids this warranty in its entirety. SureCall reserves the right to make changes in any of its products without incurring any obligation to make the same changes on previously delivered products.

As a condition to the warranties provided for herein, the Buyer will prepay the shipping charges for all products returned to SureCall for repair, and SureCall will pay the return shipping with the exception of products returned from outside the United States, in which case the Buyer will pay the shipping charges.

The Buyer will pay the cost of inspecting and testing any goods returned under the warranty or otherwise, which are found to meet the applicable specifications or which are not defective or not covered by this warranty.

Products sold by SureCall shall not be considered defective or non-conforming to the Buyer's order if they satisfactorily fulfill the performance requirements that were published in the product specification literature, or in accordance with samples provided by SureCall. This warranty shall not apply to any products or parts thereof which have been subject to accident, negligence, alteration, abuse, or misuse. SureCall makes no warranty whatsoever in respect to accessories or parts not supplied by it.

Limitations of Warranty, Damages and Liability:

EXCEPT AS EXPRESSLY SET FORTH HEREIN, THERE ARE NO WARRANTIES, CONDITIONS, GUARANTEES, OR REPRESENTATIONS AS TO MERCHANTABILITY, FITNESS FOR A PARTICULAR PURPOSE, OR OTHER WARRANTIES, CONDITIONS, GUARANTEES, OR REPRESENTATIONS, WHETHER EXPRESSED OR IMPLIED, IN LAW OR IN FACT, ORAL OR IN WRITING. SURECALL AGGREGATE LIABILITY IN DAMAGES OR OTHERWISE SHALL NOT EXCEED THE PAYMENT, IF ANY, RECEIVED BY CELLPHONE-MATE, INC. FOR THE UNIT OF PRODUCT OR SERVICE FURNISHED OR TO BE FURNISHED, AS THE CASE MAY BE, WHICH IS THE SUBJECT OF CLAIM OR DISPUTE. IN NO EVENT SHALL SURECALL BE LIABLE FOR INCIDENTAL, CONSEQUENTIAL, OR SPECIAL DAMAGES, HOWSOEVER CAUSED.

All matters regarding this warranty shall be interpreted in accordance with the laws of the State of California, and any controversy that cannot be settled directly shall be settled by arbitration in California in accordance with the rules then prevailing of the American Arbitration Association, and judgment upon the award rendered may be entered in any court having jurisdiction thereof. If one or more provisions provided herein are held to be invalid or unenforceable under applicable law, then such provision shall be ineffective and excluded to the extent of such invalidity or unenforceability without affecting in any way the remaining provisions hereof.

SAFETY INFORMATION

This is a CONSUMER device.

BEFORE USE, you MUST REGISTER THIS DEVICE with your wireless provider and have your provider's consent. Most wireless providers consent to the use of signal boosters. Some providers may not consent to the use of this device on their network. If you are unsure, contact your provider. You MUST operate this device with approved antennas and cables as specified by the manufacturer. Antennas MUST be installed at least 20 cm (8 inches) from any person. You MUST cease operating this device immediately if requested by the FCC or a licensed wireless service provider.

WARNING: E911 location information may not be provided or may be inaccurate for calls served BY USING THIS DEVICE.

48346 Milmont Drive
Fremont, California 94538
USA
888.365.6283
Fax: 510.996.7250
www.surecall.com

SureCall has made a good faith effort to ensure the accuracy of the information in this document and disclaims the implied warranties of merchantability and fitness for a particular purpose and makes no express warranties, except as may be stated in its written agreement with and for its customers. SureCall shall not be held liable to anyone for any indirect, special or consequential damages due to omissions or errors. The information and specifications in this document are subject to change without notice. © 2014. All Rights Reserved. All trademarks and registered trademarks are the property of their respective owners.

This is a **CONSUMER** device.

BEFORE USE, you **MUST REGISTER THIS DEVICE** with your wireless provider and have your provider's consent. Most wireless providers consent to the use of signal boosters. Some providers may not consent to the use of this device on their network. If you are unsure, contact your provider.

You **MUST** operate this device with approved antennas and cables as specified by the manufacturer. Antennas **MUST** be installed at least 20 cm (8 inches) from any person.

You **MUST** cease operating this device immediately if requested by the FCC or a licensed wireless service provider.

WARNING. E911 location information may not be provided or may be inaccurate for calls served by using this device.