

COBALT[®]

9933-EMDE-75/110

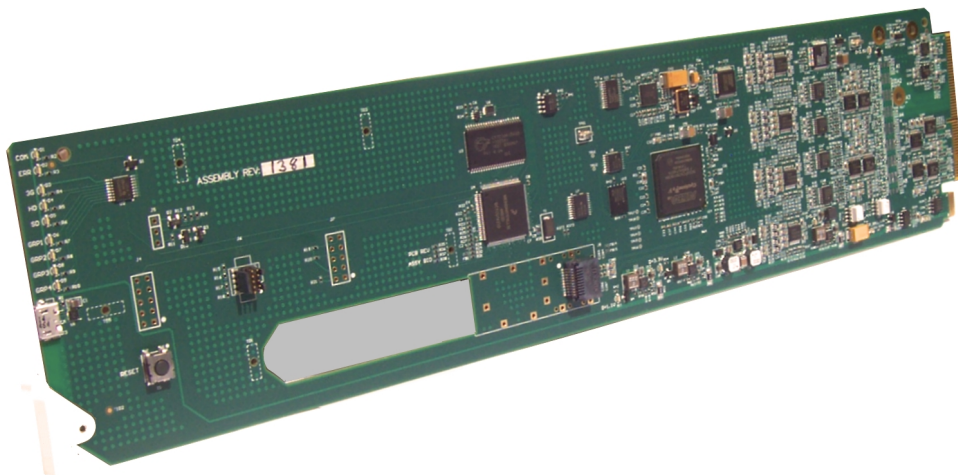

**3G/HD/SD-SDI 16-Channel Unbalanced / Balanced
AES Embedder / De-Embedder**

Product Manual

COBALT[®]

Cobalt Digital Inc.

2506 Galen Drive
Champaign, IL 61821
Voice 217.344.1243 • Fax 217.344.1245
www.cobaltdigital.com

9933EMDE-75-110-OM (V1.1)

Copyright

©Copyright 2016, Cobalt Digital Inc. All Rights Reserved.

Duplication or distribution of this manual and any information contained within is strictly prohibited without the express written permission of Cobalt Digital Inc. This manual and any information contained within, may not be reproduced, distributed, or transmitted in any form, or by any means, for any purpose, without the express written permission of Cobalt Digital Inc. Reproduction or reverse engineering of software used in this device is prohibited.

Disclaimer

The information in this document has been carefully examined and is believed to be entirely reliable. However, no responsibility is assumed for inaccuracies. Furthermore, Cobalt Digital Inc. reserves the right to make changes to any products herein to improve readability, function, or design. Cobalt Digital Inc. does not assume any liability arising out of the application or use of any product or circuit described herein.

Trademark Information

Cobalt[®] is a registered trademark of Cobalt Digital Inc.

openGear[®] is a registered trademark of Ross Video Limited. **DashBoard**[™] is a trademark of Ross Video Limited.

Dolby[®] is a registered trademark of Dolby Laboratories, Inc. Other product names or trademarks appearing in this manual are the property of their respective owners.

Congratulations on choosing the Cobalt[®] 9933-EMDE-75/110 3G/HD/SD-SDI 16-Channel Unbalanced/Balanced AES Embedder / De-Embedder. The 9933-EMDE-75/110 is part of a full line of modular processing and conversion gear for broadcast TV environments. The Cobalt Digital Inc. line includes video decoders and encoders, audio embedders and de-embedders, distribution amplifiers, format converters, remote control systems and much more. Should you have questions pertaining to the installation or operation of your 9933-EMDE-75/110 card, please contact us at the contact information on the front cover.

Manual No.:	9933EMDE-75-110-OM
Document Version:	V1.1
Release Date:	June 10, 2016
Applicable for Firmware Version (or greater):	v1.0.8
Description of product/manual changes:	- Add EMC statements to manual.

Table of Contents

Chapter 1	Introduction	1-1
	Overview	1-1
	9933-EMDE-75/110 Card Software Versions and this Manual	1-2
	Cobalt Reference Guides	1-2
	Manual Conventions	1-3
	Warnings, Cautions, and Notes	1-4
	Labeling Symbol Definitions	1-4
	Safety and Regulatory Summary	1-5
	Warnings	1-5
	Cautions	1-5
	EMC Compliance Per Market	1-5
	9933-EMDE-75/110 Functional Description	1-6
	9933-EMDE-75/110 Input/Output Formats	1-6
	Audio Processor Description	1-7
	User Control Interface	1-7
	9933-EMDE-75/110 Rear I/O Modules	1-9
	Technical Specifications	1-9
	Contact Cobalt Digital Inc.	1-10
	Warranty and Service Information	1-11
	Cobalt Digital Inc. Limited Warranty	1-11
Chapter 2	Installation and Setup	2-1
	Overview	2-1
	Installing the 9933-EMDE-75/110 Into a Frame Slot	2-1
	Installing a Rear I/O Module	2-3
	9933-EMDE-75/110 Rear I/O Modules	2-4
	Setting Up 9933-EMDE-75/110 Network Remote Control	2-5
Chapter 3	Operating Instructions	3-1
	Overview	3-1
	Control and Display Descriptions	3-1
	Function Menu/Parameter Overview	3-2
	DashBoard™ User Interface	3-3
	Accessing the 9933-EMDE Card via Remote Control	3-4
	Accessing the 9933-EMDE Card Using DashBoard™	3-4
	Checking 9933-EMDE Card Information	3-6

9933-EMDE Function Menu List and Descriptions	3-7
Input Audio Status	3-8
Output Audio Routing	3-9
Troubleshooting	3-12
Error and Failure Indicator Overview	3-12
Basic Troubleshooting Checks	3-15
9933-EMDE Processing Error Troubleshooting	3-15
Troubleshooting Network/Remote Control Errors	3-16
In Case of Problems	3-16

Introduction

Overview

This manual provides installation and operating instructions for the 9933-EMDE-75/110 3G/HD/SD-SDI 16-Channel Unbalanced/Balanced AES Embedder / De-Embedder card (also referred to herein as the 9933-EMDE-75/110).

This manual consists of the following chapters:

- **Chapter 1, “Introduction”** – Provides information about this manual and what is covered. Also provides general information regarding the 9933-EMDE-75/110.
- **Chapter 2, “Installation and Setup”** – Provides instructions for installing the 9933-EMDE-75/110 in a frame, and optionally installing a Rear I/O Module(s).
- **Chapter 3, “Operating Instructions”** – Provides overviews of operating controls and instructions for using the 9933-EMDE-75/110.

This chapter contains the following information:

- **9933-EMDE-75/110 Card Software Versions and this Manual (p. 1-2)**
- **Manual Conventions (p. 1-3)**
- **Safety and Regulatory Summary (p. 1-5)**
- **9933-EMDE-75/110 Functional Description (p. 1-6)**
- **Technical Specifications (p. 1-9)**
- **Warranty and Service Information (p. 1-11)**
- **Contact Cobalt Digital Inc. (p. 1-10)**

9933-EMDE-75/110 Card Software Versions and this Manual

When applicable, Cobalt Digital Inc. provides for continual product enhancements through software updates. As such, functions described in this manual may pertain specifically to cards loaded with a particular software build.

The Software Version of your card can be checked by viewing the **Card Info** menu in DashBoard™. See Checking 9933-EMDE Card Information (p. 3-6) in Chapter 3, “Operating Instructions” for more information. You can then check our website for the latest software version currently released for the card as described below.

Note: Not all functionality described in this manual may appear on cards with initial software versions.

Check our website and proceed as follows if your card’s software does not match the latest version:

<p>Card Software earlier than latest version</p>	<p>Card is not loaded with the latest software. Not all functions and/or specified performance described in this manual may be available.</p> <p>You can update your card with new Update software by going to the Support>Firmware Downloads link at www.cobaltdigital.com. Download “Firmware Update Guide”, which provides simple instructions for downloading the latest firmware for your card onto your computer, and then uploading it to your card through DashBoard™.</p> <p>Software updates are field-installed without any need to remove the card from its frame.</p>
<p>Card Software newer than version in manual</p>	<p>A new manual is expediently released whenever a card’s software is updated and specifications and/or functionality have changed as compared to an earlier version (a new manual is not necessarily released if specifications and/or functionality have not changed). A manual earlier than a card’s software version may not completely or accurately describe all functions available for your card.</p> <p>If your card shows features not described in this manual, you can check for the latest manual (if applicable) and download it by going to the card’s web page on www.cobaltdigital.com.</p>

Cobalt Reference Guides

From the Cobalt® web home page, go to **Support>Reference Documents** for easy to use guides covering network remote control, card firmware updates, example card processing UI setups and other topics.

Manual Conventions

In this manual, display messages and connectors are shown using the exact name shown on the 9933-EMDE-75/110 itself. Examples are provided below.

- Card-edge display messages are shown like this:



BOOT

- Connector names are shown like this: **SDI IN A**

In this manual, the terms below are applicable as follows:

- **9933-EMDE-75/110** refers to the 9933-EMDE-75/110 3G/HD/SD-SDI 16-Channel Unbalanced/Balanced AES Embedder / De-Embedder card.
- **Frame** refers to the HPF-9000, OG3-FR, 8321, or similar 20-slot frame that houses Cobalt® or other cards.
- **Device** and/or **Card** refers to a Cobalt® or other card.
- **System** and/or **Video System** refers to the mix of interconnected production and terminal equipment in which the 9933-EMDE-75/110 and other cards operate.
- Functions and/or features that are available only as an option are denoted in this manual like this:



Option ➔

Warnings, Cautions, and Notes

Certain items in this manual are highlighted by special messages. The definitions are provided below.

Warnings

Warning messages indicate a possible hazard which, if not avoided, could result in personal injury or death.



Cautions

Caution messages indicate a problem or incorrect practice which, if not avoided, could result in improper operation or damage to the product.

Notes

Notes provide supplemental information to the accompanying text. Notes typically precede the text to which they apply.

Labeling Symbol Definitions

	<p>Important note regarding product usage. Failure to observe may result in unexpected or incorrect operation.</p>
	<p>Electronic device or assembly is susceptible to damage from an ESD event. Handle only using appropriate ESD prevention practices.</p> <p>If ESD wrist strap is not available, handle card only by edges and avoid contact with any connectors or components.</p>
	<p>Symbol (WEEE 2002/96/EC)</p> <p>For product disposal, ensure the following:</p> <ul style="list-style-type: none"> • Do not dispose of this product as unsorted municipal waste. • Collect this product separately. • Use collection and return systems available to you.

Safety and Regulatory Summary

Warnings

! WARNING !

To reduce risk of electric shock do not remove line voltage service barrier cover on frame equipment containing an AC power supply. **NO USER SERVICEABLE PARTS INSIDE. REFER SERVICING TO QUALIFIED SERVICE PERSONNEL.**

Cautions

CAUTION

This device is intended for environmentally controlled use only in appropriate video terminal equipment operating environments.

CAUTION

This product is intended to be a component product of an openGear® frame. Refer to the openGear® frame Owner's Manual for important safety instructions regarding the proper installation and safe operation of the frame as well as its component products.

CAUTION

Heat and power distribution requirements within a frame may dictate specific slot placement of cards. Cards with many heat-producing components should be arranged to avoid areas of excess heat build-up, particularly in frames using only convection cooling. The card has a moderate power dissipation (<18 W). As such, avoiding placing the card adjacent to other cards with similar dissipation values if possible.

CAUTION

If required, make certain Rear I/O Module(s) is installed before installing the card into the frame slot. Damage to card and/or Rear I/O Module can occur if module installation is attempted with card already installed in slot.

CAUTION

If card resists fully engaging in rear I/O module mating connector, check for alignment and proper insertion in slot tracks. Damage to card and/or rear I/O module may occur if improper card insertion is attempted.

EMC Compliance Per Market

Market	Regulatory Standard or Code
United States of America	FCC "Code of Federal Regulations" Title 47 Part 15, Subpart B, Class A
Canada	ICES-003
International/CE	CISPR 24:2010 IEC 61000-4-2:2008 IEC 61000-4-3:2006 with A1:2007 and A2:2010 IEC 61000-4-4:2004 IEC 61000-4-6:2008 CISPR 22:2008

9933-EMDE-75/110 Functional Description

Figure 1-1 shows a functional block diagram of the 9933-EMDE-75/110. The card provides de-embedding or embedding between 75Ω unbalanced AES-3id and 110Ω balanced AES/EBU professional balanced digital audio and SMPTE embedded audio using full 24-bit conversion. In addition to individual per-pair embedding or de-embedding, the card can be used to provide cross-balun I/O functions. Full audio crosspoints allow per-channel gain and routing controls, as well as built-in tone generators. GUI audio meters provide ready assessment of content presence and line-up.

9933-EMDE-75/110 Input/Output Formats

The 9933-EMDE-75/110 provides the following inputs and outputs:

- **Inputs:**
 - **3G/HD/SD SDI IN** – 3G/HD/SD-SDI coaxial input.
 - **AES I/O** – Up to 16 channels (8 pairs) of embedding inputs from either unbalanced or balanced AES sources.
- **Outputs:**
 - **3G/HD/SD-SDI OUT** – 3G/HD/SD-SDI coaxial output.
 - **AES I/O** – Up to 16 channels (8 pairs) of de-embedded outputs to either unbalanced or balanced AES.

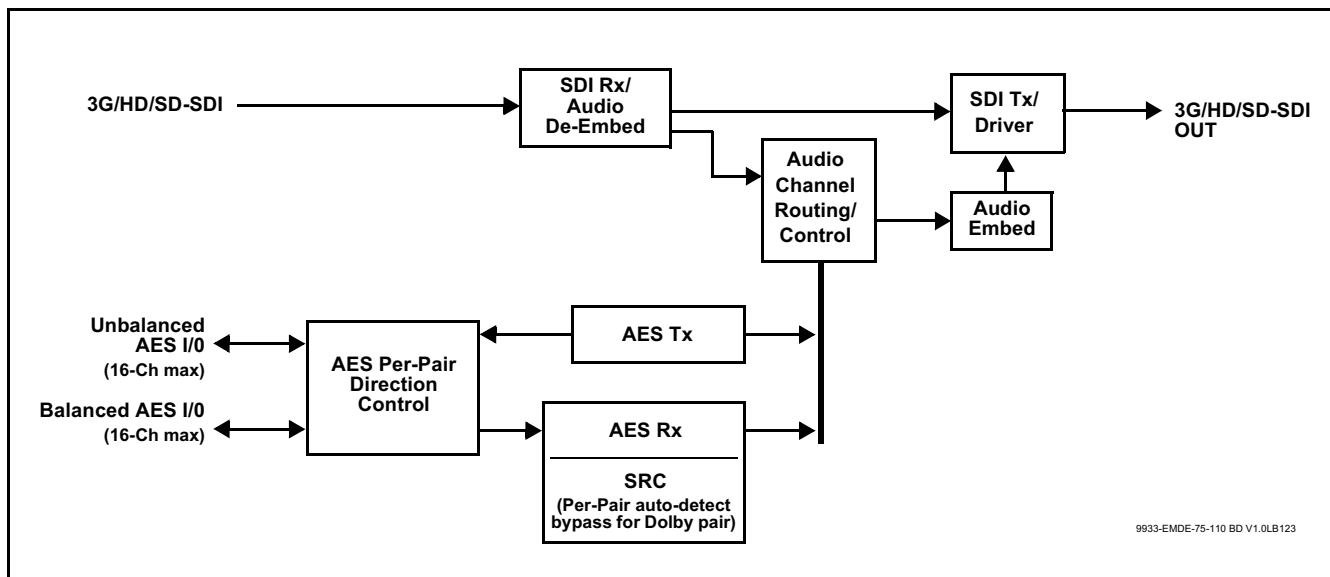

Figure 1-1 9933-EMDE-75/110 Functional Block Diagrams

Audio Processor Description

The audio processor operates as an internal audio router. This function chooses from the following inputs:

- 16 channels of embedded audio from the SDI video input (default 1-to-1 routing to SDI output)
- Up to 16 channels (8 pairs) of AES-3id or AES/EBU audio inputs or outputs between AES I/O ports and embedded audio

The audio processing subsection is built around a card internal 16-channel audio bus. Audio embed adaptive SRC allows asynchronous 48 kHz AES audio to automatically sync with program video 48 kHz timing for glitch-free embedding. Individual, per-pair SRC auto-detects and disables SRC when a Dolby pair is detected on an input pair.

Audio status (presence, dBFS signal levels) is displayed for each embedded and AES input channel.

User Control Interface

Figure 1-2 shows the user control interface options for the 9933-EMDE-75/110. These options are individually described below.

Note: All user control interfaces described here are cross-compatible and can operate together as desired. Where applicable, any control setting change made using a particular user interface is reflected on any other connected interface.

- **DashBoard™ User Interface** – Using DashBoard™, the 9933-EMDE-75/110 and other cards installed in openGear®¹ frames can be controlled from a computer and monitor.

DashBoard™ allows users to view all frames on a network with control and monitoring for all populated slots inside a frame. This simplifies the setup and use of numerous modules in a large installation and offers the ability to centralize monitoring. Cards define their controllable parameters to DashBoard™, so the control interface is always up to date.

The DashBoard™ software can be downloaded from the Cobalt Digital Inc. website: www.cobaltdigital.com (enter “DashBoard” in the search window). The DashBoard™ user interface is described in Chapter 3, “Operating Instructions”.

1. openGear® is a registered trademark of Ross Video Limited. DashBoard™ is a trademark of Ross Video Limited.

- **Cobalt® OGCP-9000 and OGCP-9000/CC Remote Control Panels** – The OGCP-9000 and OGCP-9000/CC Remote Control Panels conveniently and intuitively provide parameter monitor and control of the 9933-EMDE-75/110 and other video and audio processing terminal equipment meeting the open-architecture Cobalt® cards for openGear™ standard.

In addition to circumventing the need for a computer to monitor and control signal processing cards, the Control Panels allow quick and intuitive access to hundreds of cards in a facility, and can monitor and allow adjustment of multiple parameters at one time.

The Remote Control Panels are totally compatible with the openGear™ control software DashBoard™; any changes made with either system are reflected on the other.

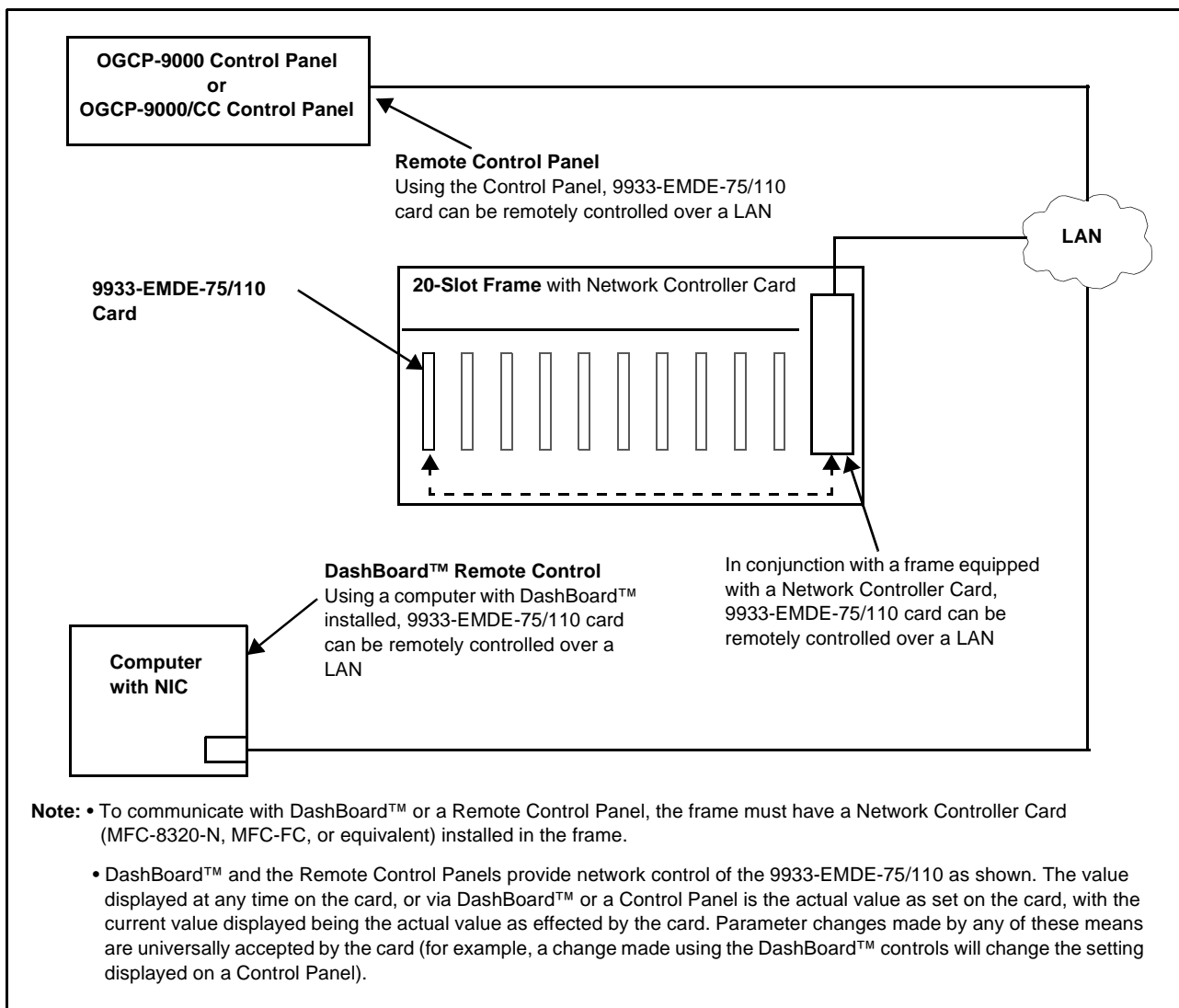

Figure 1-2 9933-EMDE-75/110 User Control Interface

Note: If network remote control is to be used for the frame and the frame has not yet been set up for remote control, Cobalt® reference guide **Remote Control User Guide (PN 9000RCS-RM)** provides thorough information and step-by-step instructions for setting up network remote control of Cobalt® cards using DashBoard™. (Cobalt® OGCP-9000 and OGCP-9000/CC Remote Control Panel product manuals have complete instructions for setting up remote control using a Remote Control Panel.)

Download a copy of this guide by clicking on the **Support>Reference Documents** link at www.cobaltdigital.com and then select DashBoard Remote Control Setup Guide as a download, or contact Cobalt® as listed in Contact Cobalt Digital Inc. (p. 1-10).

9933-EMDE-75/110 Rear I/O Modules

The 9933-EMDE-75/110 physically interfaces to system video connections at the rear of its frame using a Rear I/O Module.

All inputs and outputs shown in the 9933-EMDE-75/110 Functional Block Diagrams (Figure 1-1) enter and exit the card via the card edge backplane connector. The Rear I/O Module breaks out the 9933-EMDE-75/110 card edge connections to BNC and other connectors that interface with other components and systems in the signal chain.

The full assortment of 9933-EMDE-75/110 Rear I/O Modules is shown and described in 9933-EMDE-75/110 Rear I/O Modules (p. 2-4) in Chapter 2, “Installation and Setup”.

Technical Specifications

Table 1-1 lists the technical specifications for the 9933-EMDE-75/110 3G/HD/SD-SDI 16-Channel Unbalanced/Balanced AES Embedder / De-Embedder card.

Table 1-1 Technical Specifications

Item	Characteristic
Part number, nomenclature	9933-EMDE-75/110 3G/HD/SD-SDI 16-Channel Unbalanced/Balanced AES Embedder / De-Embedder
Installation/usage environment	Intended for installation and usage in frame meeting openGear™ modular system definition
Power consumption	< 18 Watts maximum
Installation Density	Up to 20 cards per 20-slot frame
Environmental: Operating temperature: Relative humidity (operating or storage):	32° – 104° F (0° – 40° C) < 95%, non-condensing
Frame communication	10/100 Mbps Ethernet with Auto-MDIX

Table 1-1 Technical Specifications — continued

Item	Characteristic
Indicators	Card edge display and indicators as follows: <ul style="list-style-type: none"> • Status/Error LED indicator • Input Presence (3G/HD/SD) LED indicators
SDI Inputs/Outputs	(1) 75Ω BNC input (1) 75Ω BNC output SDI Receive Cable Length (1694A): 120m/180m/360m (3G/HD/SD) SDI Return Loss: >15 dB up to 1.485 GHz; >10 dB up to 2.970 GHz Note: SDI Return loss and receive cable length are affected by rear I/O module used. Specifications represent typical performance. Alignment Jitter: 3G/HD/SD: < 0.3/0.2/0.2 UI Timing Jitter: 3G/HD/SD: < 2.0/1.0/0.2 UI SDI Formats Supported: SMPTE 259M, SMPTE 292M, SMPTE 424M
Audio Conversion Format	48 kHz sampling, 24-bit. Auto-SRC bypass for Dolby inputs.
AES Audio Input/Output	(8-pair) Unbalanced AES-3id audio input/outputs with per-pair port direction controls, Input Impedance: 75 Ω (8-pair) Balanced AES/EBU audio input/outputs with per-pair port direction controls, Input Impedance: 110 Ω

Contact Cobalt Digital Inc.

Feel free to contact our thorough and professional support representatives for any of the following:

- Name and address of your local dealer
- Product information and pricing
- Technical support
- Upcoming trade show information

Phone:	(217) 344-1243
Fax:	(217) 344-1245
Web:	www.cobaltdigital.com
General Information:	info@cobaltdigital.com
Technical Support:	support@cobaltdigital.com

Warranty and Service Information

Cobalt Digital Inc. Limited Warranty

This product is warranted to be free from defects in material and workmanship for a period of five (5) years from the date of shipment to the original purchaser, except that 4000, 5000, 6000, 8000 series power supplies, and Dolby® modules (where applicable) are warranted to be free from defects in material and workmanship for a period of one (1) year.

Cobalt Digital Inc.'s ("Cobalt") sole obligation under this warranty shall be limited to, at its option, (i) the repair or (ii) replacement of the product, and the determination of whether a defect is covered under this limited warranty shall be made at the sole discretion of Cobalt.

This limited warranty applies only to the original end-purchaser of the product, and is not assignable or transferrable therefrom. This warranty is limited to defects in material and workmanship, and shall not apply to acts of God, accidents, or negligence on behalf of the purchaser, and shall be voided upon the misuse, abuse, alteration, or modification of the product. Only Cobalt authorized factory representatives are authorized to make repairs to the product, and any unauthorized attempt to repair this product shall immediately void the warranty. Please contact Cobalt Technical Support for more information.

To facilitate the resolution of warranty related issues, Cobalt recommends registering the product by completing and returning a product registration form. In the event of a warrantable defect, the purchaser shall notify Cobalt with a description of the problem, and Cobalt shall provide the purchaser with a Return Material Authorization ("RMA"). For return, defective products should be double boxed, and sufficiently protected, in the original packaging, or equivalent, and shipped to the Cobalt Factory Service Center, postage prepaid and insured for the purchase price. The purchaser should include the RMA number, description of the problem encountered, date purchased, name of dealer purchased from, and serial number with the shipment.

Cobalt Digital Inc. Factory Service Center

2506 Galen Drive

Champaign, IL 61821 USA

www.cobaltdigital.com

Office: (217) 344-1243

Fax: (217) 344-1245

Email: info@cobaltdigital.com

THIS LIMITED WARRANTY IS EXPRESSLY IN LIEU OF ALL OTHER WARRANTIES EXPRESSED OR IMPLIED, INCLUDING THE WARRANTIES OF MERCHANTABILITY AND FITNESS FOR A PARTICULAR PURPOSE AND OF ALL OTHER OBLIGATIONS OR LIABILITIES ON COBALT'S PART. ANY SOFTWARE PROVIDED WITH, OR FOR USE WITH, THE PRODUCT IS PROVIDED "AS IS." THE BUYER OF THE PRODUCT ACKNOWLEDGES THAT NO OTHER REPRESENTATIONS WERE MADE OR RELIED UPON WITH RESPECT TO THE QUALITY AND FUNCTION OF THE GOODS HEREIN SOLD. COBALT PRODUCTS ARE NOT AUTHORIZED FOR USE IN LIFE SUPPORT APPLICATIONS.

COBALT'S LIABILITY, WHETHER IN CONTRACT, TORT, WARRANTY, OR OTHERWISE, IS LIMITED TO THE REPAIR OR REPLACEMENT, AT ITS OPTION, OF ANY DEFECTIVE PRODUCT, AND SHALL IN NO EVENT INCLUDE SPECIAL, INDIRECT, INCIDENTAL, OR CONSEQUENTIAL DAMAGES (INCLUDING LOST PROFITS), EVEN IF IT HAS BEEN ADVISED OF THE POSSIBILITY OF SUCH DAMAGES.

This page intentionally blank

Installation and Setup

Overview

This chapter contains the following information:

- Installing the 9933-EMDE-75/110 Into a Frame Slot (p. 2-1)
- Installing a Rear I/O Module (p. 2-3)
- Setting Up 9933-EMDE-75/110 Network Remote Control (p. 2-5)

Installing the 9933-EMDE-75/110 Into a Frame Slot

CAUTION

Heat and power distribution requirements within a frame may dictate specific slot placement of cards. Cards with many heat-producing components should be arranged to avoid areas of excess heat build-up, particularly in frames using only convection cooling. The card has a moderate power dissipation (<18 W). As such, avoiding placing the card adjacent to other cards with similar dissipation values if possible.

CAUTION



This device contains semiconductor devices which are susceptible to serious damage from Electrostatic Discharge (ESD). ESD damage may not be immediately apparent and can affect the long-term reliability of the device.

Avoid handling circuit boards in high static environments such as carpeted areas, and when wearing synthetic fiber clothing. Always use proper ESD handling precautions and equipment when working on circuit boards and related equipment.

Note: If installing the card in a slot with no rear I/O module, a Rear I/O Module is required before cabling can be connected. Refer to Installing a Rear I/O Module (p. 2-3) for rear I/O module installation procedure.

CAUTION

If required, make certain Rear I/O Module(s) is installed before installing the card into the frame slot. Damage to card and/or Rear I/O Module can occur if module installation is attempted with card already installed in slot.

Note: Check the packaging in which the card was shipped for any extra items such as a Rear I/O Module connection label. In some cases, this label is shipped with the card and to be installed on the Rear I/O connector bank corresponding to the slot location of the card.

Install the card into a frame slot as follows:

1. Determine the slot in which the card is to be installed.
2. Open the frame front access panel.
3. While holding the card by the card edges, align the card such that the plastic ejector tab is on the bottom.
4. Align the card with the top and bottom guides of the slot in which the card is being installed.
5. Gradually slide the card into the slot. When resistance is noticed, gently continue pushing the card until its rear printed circuit edge terminals engage fully into the rear I/O module mating connector.

CAUTION

If card resists fully engaging in rear I/O module mating connector, check for alignment and proper insertion in slot tracks. Damage to card and/or rear I/O module may occur if improper card insertion is attempted.

6. Verify that the card is fully engaged in rear I/O module mating connector.
7. Close the frame front access panel.
8. Connect the input and output cables as shown in 9933-EMDE-75/110 Rear I/O Modules (p. 2-4).
9. Repeat steps 1 through 8 for other cards.

Note:

- The card BNC inputs are internally 75-ohm terminated. It is not necessary to terminate unused BNC inputs or outputs.
- To remove a card, press down on the ejector tab to unseat the card from the rear I/O module mating connector. Evenly draw the card from its slot.

10. If network remote control is to be used for the frame and the frame has not yet been set up for remote control, perform setup in accordance with Setting Up 9933-EMDE-75/110 Network Remote Control (p. 2-5).

Note: If installing a card in a frame already equipped for, and connected to DashBoard™, no network setup is required for the card. The card will be discovered by DashBoard™ and be ready for use.

Installing a Rear I/O Module

Note: This procedure is applicable **only if a Rear I/O Module is not currently installed** in the slot where the card is to be installed.

If installing the card in a slot already equipped with a suitable I/O module, omit this procedure.

Install a Rear I/O Module as follows:

1. On the frame, determine the slot in which the card is to be installed.
2. In the mounting area corresponding to the slot location, install Rear I/O Module as shown in Figure 2-1.

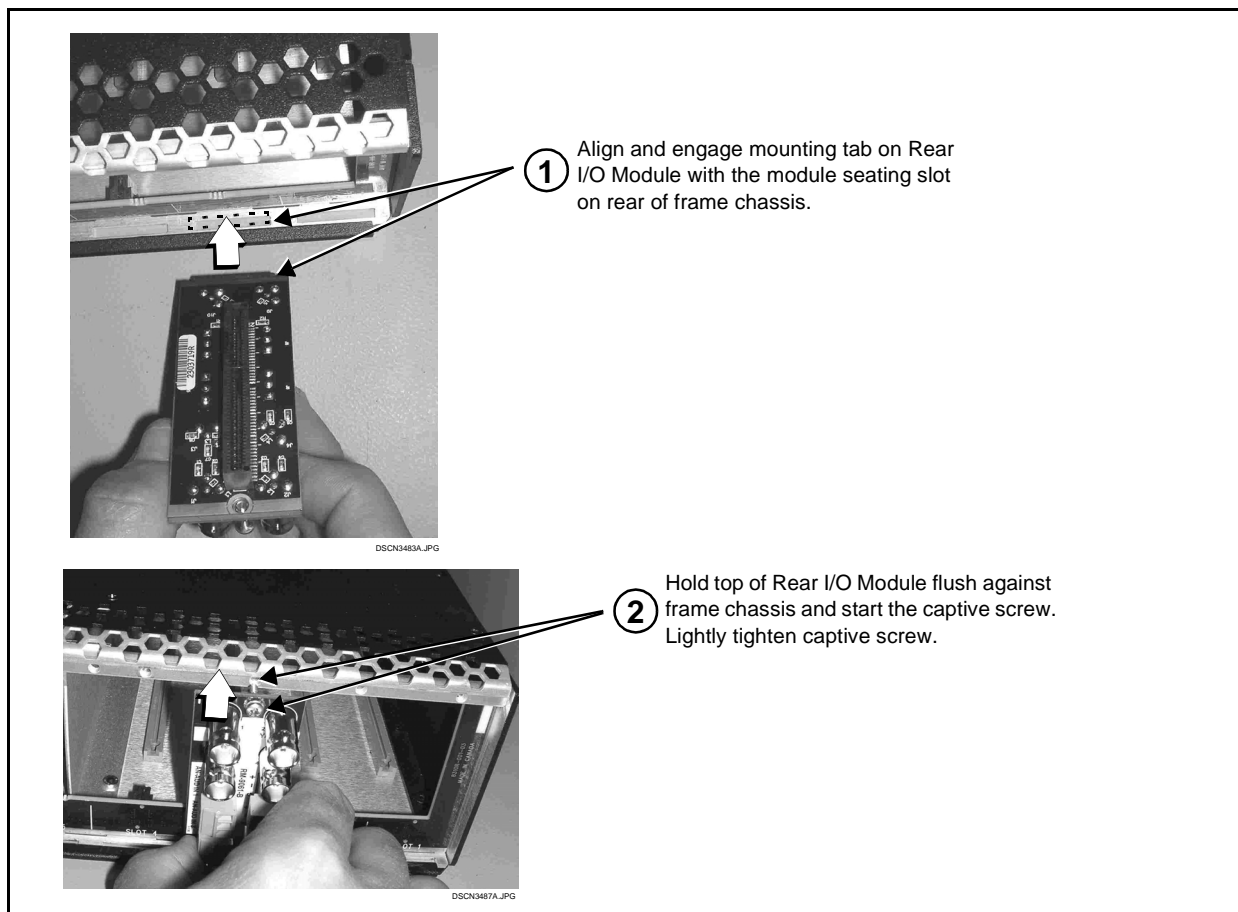
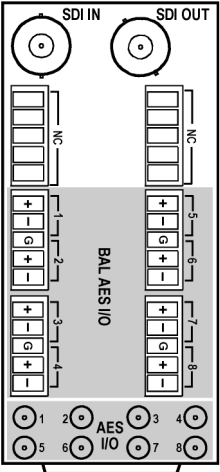
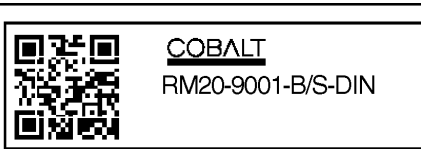

Figure 2-1 Rear I/O Module Installation

9933-EMDE-75/110 Rear I/O Modules

Table 2-1 shows and describes the full assortment of Rear I/O Modules specifically for use with the 9933-EMDE-75/110. Figure 2-2 shows how to connect wiring to removable multipin connectors.

Table 2-1 9933-EMDE-75/110 Rear I/O Modules

9933-EMDE-75/110 Rear I/O Module	Description
<p>RM20-9933EMDE-A</p> 	<p>Provides the following connections:</p> <ul style="list-style-type: none"> • One 3G/HD/SD-SDI input BNC (SDI IN) • Eight AES/EBU balanced audio input/outputs (BAL AES AUD I/O 1 thru AES AUD I/O 8) • Eight AES-3id unbalanced audio input/outputs (UNBAL AES AUD I/O 1 thru AES AUD I/O 8) • One 3G/HD/SD-SDI output BNC (SDI OUT) <p>Note: AES coaxial connectors are DIN1.0/2.3 or HD-BNC. Available equipped with High-Density BNC (HDBNC) or DIN1.0/2.3 connectors as: RM20-9933EMDE-A-HDBNC or RM20-9933EMDE-A-DIN, respectively.</p>
 <p>COBALT RM20-9001-B/S-DIN</p> <p>**SAMPLE-NOT FOR USE**</p>	<p>Due to the density of connector placement on Rear Modules using high-density connectors (e.g., RM20-9001-B/S-DIN), these modules use a QR barcode label instead a regular label. Simply scan the image with a smart phone and a link to the rear module label (as shown in our catalog) will appear. (Smart phone must have a QR reader app such as QuickMark QR Code Reader or equivalent.)</p> <p>Not all devices may be able to acquire the image. If this occurs, use the device to access the web page for card/rear module to view the diagram.</p>

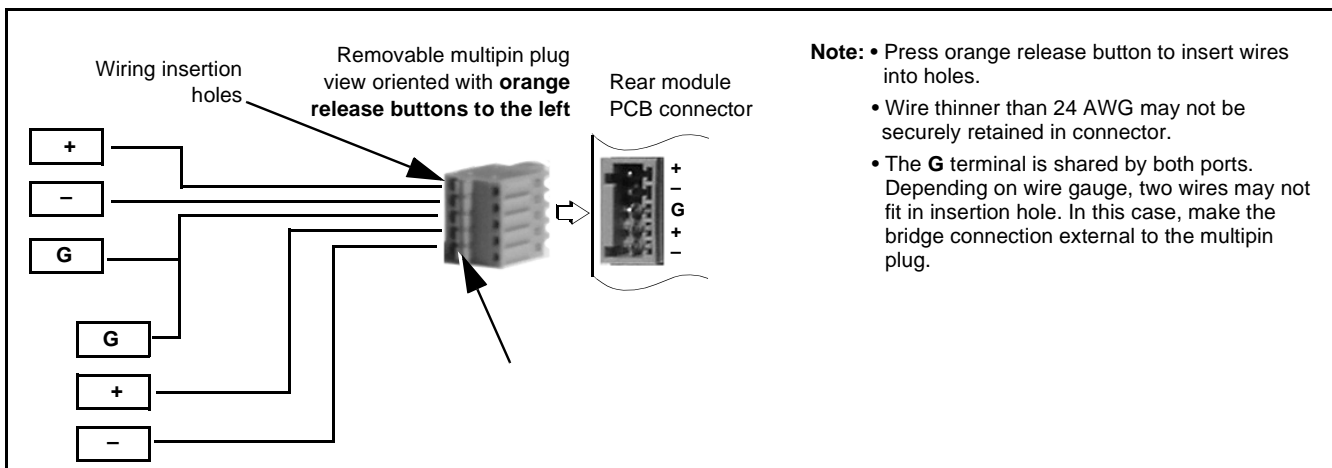

Figure 2-2 Balanced Audio Connector Pinouts

Setting Up 9933-EMDE-75/110 Network Remote Control

Perform remote control setup in accordance with Cobalt® reference guide “Remote Control User Guide” (PN 9000RCS-RM).

- Note:**
- If network remote control is to be used for the frame and the frame has not yet been set up for remote control, Cobalt® reference guide **Remote Control User Guide (PN 9000RCS-RM)** provides thorough information and step-by-step instructions for setting up network remote control of Cobalt® cards using DashBoard™. (Cobalt® OGCP-9000 and OGCP-9000/CC Remote Control Panel product manuals have complete instructions for setting up remote control using a Remote Control Panel.)

Download a copy of this guide by clicking on the **Support>Reference Documents** link at www.cobaltdigital.com and then select DashBoard Remote Control Setup Guide as a download, or contact Cobalt® as listed in Contact Cobalt Digital Inc. (p. 1-10).

- If installing a card in a frame already equipped for, and connected to DashBoard™, no network setup is required for the card. The card will be discovered by DashBoard™ and be ready for use.

This page intentionally blank

Operating Instructions

Overview

If you are already familiar with using DashBoard or a Cobalt Remote Control Panel to control Cobalt cards, please skip to 9933-EMDE Function Menu List and Descriptions (p. 3-7).

This chapter contains the following information:

- Control and Display Descriptions (p. 3-1)
- Accessing the 9933-EMDE Card via Remote Control (p. 3-4)
- Checking 9933-EMDE Card Information (p. 3-6)
- 9933-EMDE Function Menu List and Descriptions (p. 3-7)
- Troubleshooting (p. 3-12)

Control and Display Descriptions

This section describes the user interface controls, indicators, and displays for using the 9933-EMDE-75/110 card. The 9933-EMDE-75/110 functions can be accessed and controlled using any of the user interfaces described here.

The format in which the 9933-EMDE-75/110 functional controls, indicators, and displays appear and are used varies depending on the user interface being used. Regardless of the user interface being used, access to the 9933-EMDE-75/110 functions (and the controls, indicators, and displays related to a particular function) follows a general arrangement of Function Menus under which related controls can be accessed (as described in Function Menu/Parameter Overview below).

Note: When a setting is changed, settings displayed on DashBoard™ (or a Remote Control Panel) are the settings as effected by the card itself and reported back to the remote control; the value displayed at any time is the actual value as set on the card.

Function Menu/Parameter Overview

The functions and related parameters available on the 9933-EMDE-75/110 card are organized into function **menus**, which consist of parameter groups as shown below.

Figure 3-1 shows how the 9933-EMDE-75/110 card and its menus are organized, and also provides an overview of how navigation is performed between cards, function menus, and parameters.

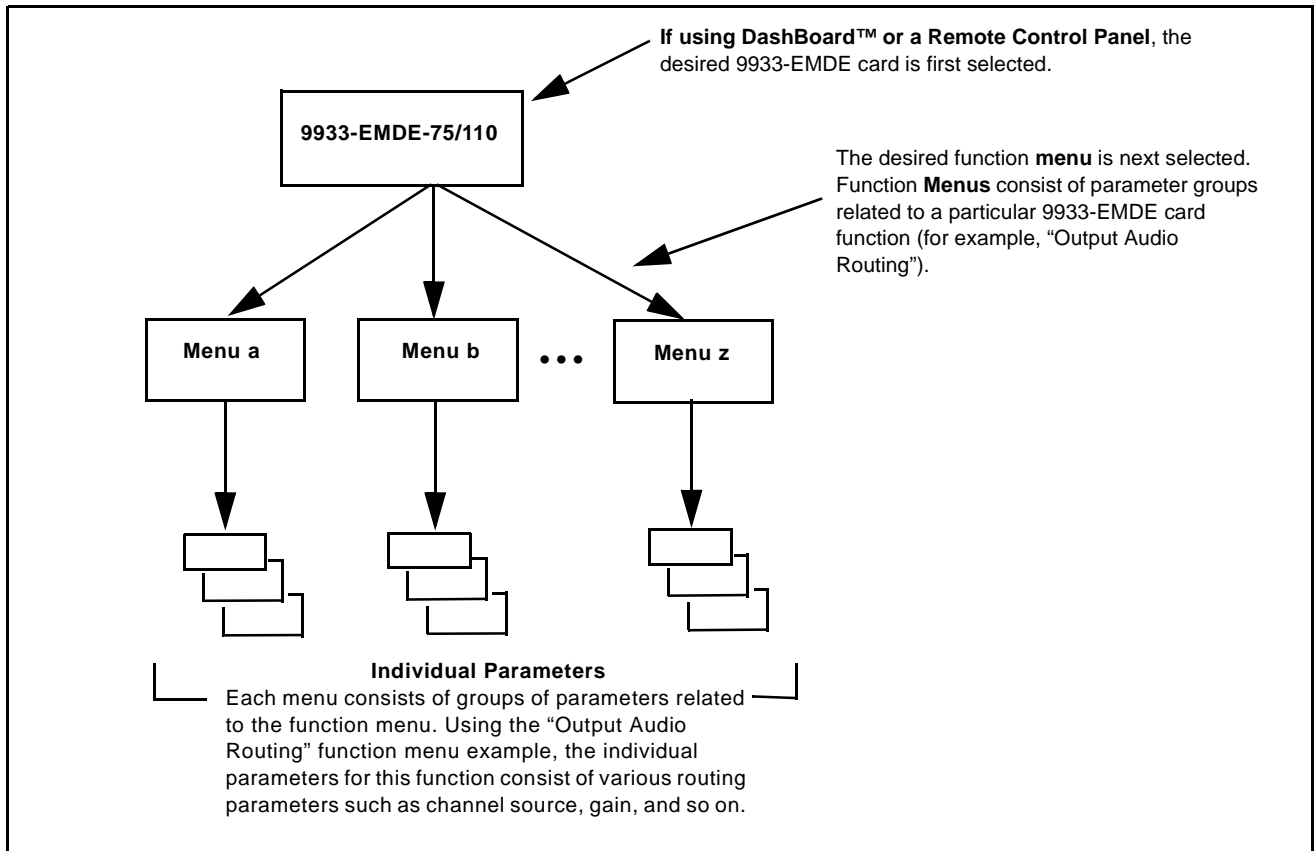

Figure 3-1 Function Menu/Parameter Overview

DashBoard™ User Interface

(See Figure 3-2.) The card function menus are organized in DashBoard™ using tabs. When a tab is selected, each parametric control or selection list item associated with the function is displayed. Scalar (numeric) parametric values can then be adjusted as desired using the GUI slider controls. Items in a list can then be selected using GUI drop-down lists.

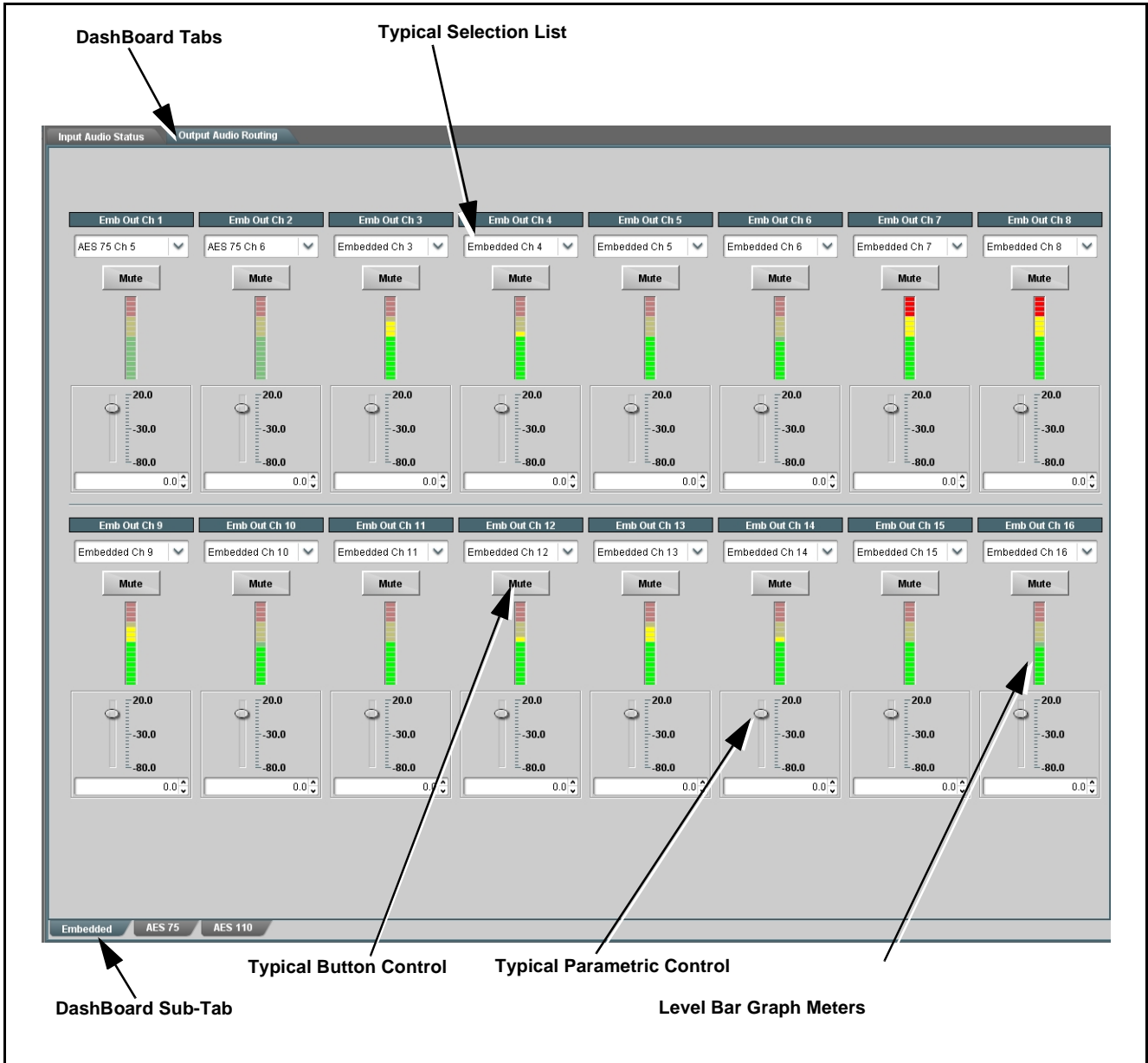

Figure 3-2 Typical DashBoard Tabs and Controls

Accessing the 9933-EMDE Card via Remote Control

Access the 9933-EMDE card using DashBoard™ or Cobalt® Remote Control Panel as described below.

Accessing the 9933-EMDE Card Using DashBoard™

1. On the computer connected to the frame LAN, open DashBoard™.
2. As shown below, in the left side Basic View Tree locate the Network Controller Card associated with the frame containing the 9933-EMDE card to be accessed (in this example, “MFC-8320-N SN: 00108053”).

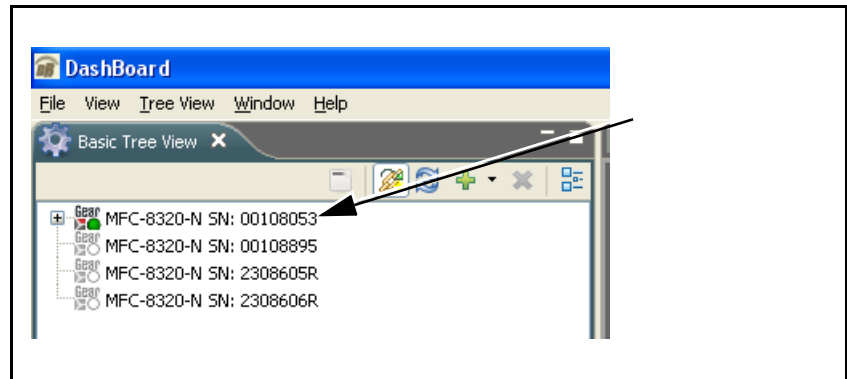

3. As shown below, expand the tree to access the cards within the frame. Click on the card to be accessed (in this example, “Slot 6: 9933-EMDE-75/110”).

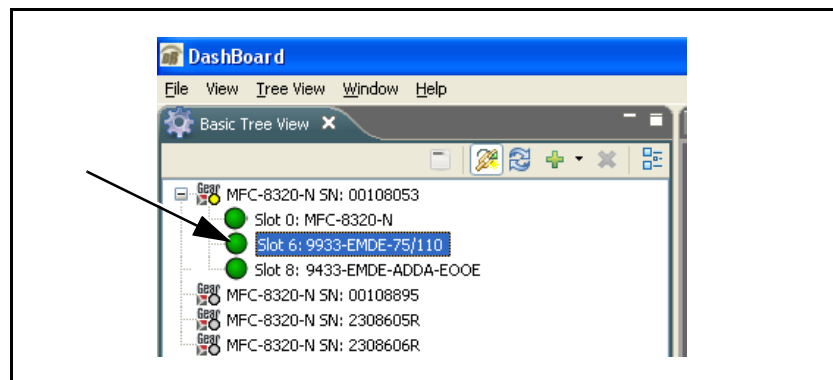

As shown on the next page, when the card is accessed in DashBoard™ its function menu screen showing tabs for each function is displayed. (The particular menu screen displayed is the previously displayed screen from the last time the card was accessed by DashBoard™).

The screenshot displays a software interface for remote control of a 9933-EMDE card. The interface is organized into three primary sections:

- Card Access/Navigation Tree Pane:** Located on the left, it shows a hierarchical tree view of system components, including various 'CobaltFrame' instances, 'Demo' kits, and specific frame configurations like 'Jonathan 20 Slot Frame' and 'Kyle Desk Frame'.
- Card Info Pane:** Located in the middle-left, it provides detailed information for 'Slot 18: 9902-UDX'. Key indicators include 'Card state: OK' and 'Connection: ONLINE'. It also lists various status parameters such as 'Output Video', 'SDI Input A-D', 'GPI1-2', 'Reference 1', 'Card Voltage', 'Card Power', 'Card Temp Front/Rear', 'Card Temp FPGA', 'Card Up Time', and 'Card IP'.
- Card Function Menu and Controls Pane:** Occupies the right side and contains a menu of control options: 'Moving Box', 'Output Audio Routing/Controls', 'Input Audio Status', 'YC Alignment', 'Input Audio Routing/Controls', 'Wings/Keyer', 'AFD/WSS/M', 'Input Video', 'GPIO', 'Timecode', 'Presets', 'Closed Captioning', 'Video Quality Events', 'Log Firmware Update', 'Character Burner', 'Framesync', and 'Scaler'. Below the menu, there are several control elements:
 - 'Scaler Enable' set to 'Scaler Enabled'.
 - 'Input Video' and 'Output Video' both set to '1080i_5994'.
 - 'Output Format' set to 'Match Input'.
 - A row of five preset buttons: 'Unity 1.0HV', 'Pillar Box 0.75H', 'Center Cut 1.33H', 'Letter Box 0.75V', and 'Vertical Center Cut 1.33V', each with an 'Apply' button.
 - 'Aspect Ratio Horizontal' and 'Aspect Ratio Vertical' sliders, both currently at 100.0.
 - 'H Pan' and 'V Pan' sliders, both currently at 0.0.

Checking 9933-EMDE Card Information

The operating status and software version the 9933-EMDE card can be checked using DashBoard™ or the card edge control user interface. Figure 3-3 shows and describes the 9933-EMDE card information screen using DashBoard™.

Note: Proper operating status in DashBoard™ is denoted by green icons for the status indicators shown in Figure 3-3. Yellow or red icons respectively indicate an alert or failure condition. Refer to Troubleshooting (p. 3-12) for corrective action.

The **Tree View** shows the cards seen by DashBoard™. In this example, Network Controller Card is hosting a 9933-EMDE card in slot 12.

Status Display
This display shows the status and format of the signals being received by the 9933-EMDE, as well as card status. This display also shows the the card hardware and software version info.

Figure 3-3 9933-EMDE Card Info/Status Utility

9933-EMDE Function Menu List and Descriptions

Table 3-1 individually lists and describes each 9933-EMDE function menu and its related list selections, controls, and parameters. Where helpful, examples showing usage of a function are also provided. Table 3-1 is primarily based upon using DashBoard™ to access each function and its corresponding menus and parameters.

Note: All numeric (scalar) parameters displayed on DashBoard™ can be changed using the slider controls, , or by numeric keypad entry in the corresponding numeric field. (When using numeric keypad entry, add a return after the entry to commit the entry.)

On DashBoard™ itself and in Table 3-1, the function menu items are organized using tabs as shown below.

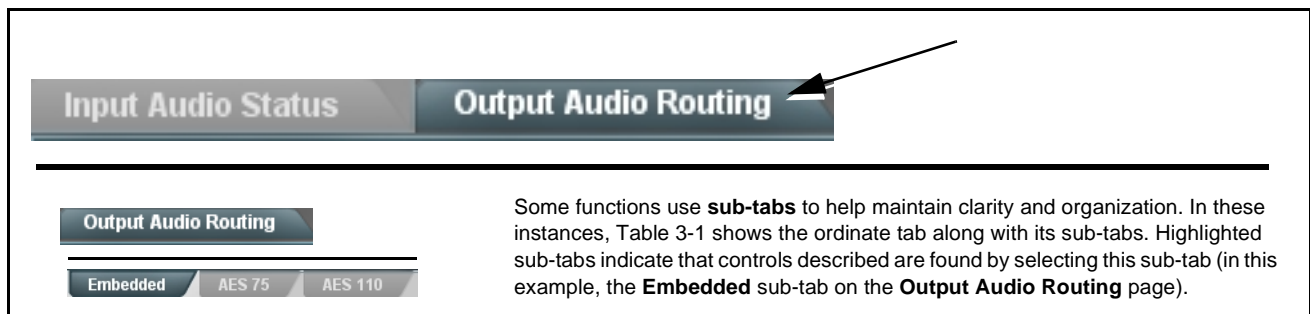

The table below provides a quick-reference to the page numbers where each function menu item can be found.

Function Menu Item	Page	Function Menu Item	Page
Input Audio Status	3-8	Output Audio Routing	3-9

Table 3-1 9933-EMDE Function Menu List

<h2 style="margin: 0;">Input Audio Status</h2>	<p>Displays signal status and payload for embedded and discrete audio received by the card. Also provides AES port user direction indication/control.</p>																																																																		
<p>Individual signal status and peak level displays for embedded audio input pairs, and AES/analog input pairs as described below. AES pair status also shows sample rate.</p>																																																																			
<ul style="list-style-type: none"> • Absent: Indicates embedded channel or AES pair does not contain recognized audio PCM data. • Present PCM: Indicates AES pair or embedded channel contains recognized audio PCM data. Running per-channel peak level is also displayed (Dolby data will show as "PCM" but will exhibit a steady per-pair 0 dBFS level). <p>Note: AES Dolby-encoded inputs are directed via a special path that automatically bypasses SRC.</p>																																																																			
<p>The screenshot shows the 'Input Audio Status' window with two tabs: 'Input Audio Status' (selected) and 'Output Audio Routing'. The window is divided into three main sections: Embedded, AES 75, and AES 110. Each section has a table with 'Status' and 'Peak' columns. The 'Direction' column for AES channels contains 'Output' or 'Input' buttons. An arrow points to the 'Output' button for AES 75 Ch 3-4.</p> <table border="1" style="width: 100%; border-collapse: collapse;"> <thead> <tr> <th colspan="3" style="background-color: #444; color: white;">Embedded</th> </tr> <tr> <th style="width: 15%;">Status</th> <th style="width: 45%;">Peak</th> <th style="width: 40%;"></th> </tr> </thead> <tbody> <tr> <td>Emb Ch 1-2</td> <td>Present PCM</td> <td>-78 dBFS / -77 dBFS</td> </tr> <tr> <td>Emb Ch 3-4</td> <td>Present PCM</td> <td>-19 dBFS / -29 dBFS</td> </tr> <tr> <td>Emb Ch 5-6</td> <td>Present PCM</td> <td>-34 dBFS / -39 dBFS</td> </tr> <tr> <td>Emb Ch 7-8</td> <td>Present PCM</td> <td>0 dBFS / 0 dBFS</td> </tr> <tr> <td>Emb Ch 9-10</td> <td>Present PCM</td> <td>-19 dBFS / -39 dBFS</td> </tr> <tr> <td>Emb Ch 11-12</td> <td>Present PCM</td> <td>-34 dBFS / -29 dBFS</td> </tr> <tr> <td>Emb Ch 13-14</td> <td>Present PCM</td> <td>-19 dBFS / -29 dBFS</td> </tr> <tr> <td>Emb Ch 15-16</td> <td>Present PCM</td> <td>-34 dBFS / -39 dBFS</td> </tr> </tbody> </table> <table border="1" style="width: 100%; border-collapse: collapse;"> <thead> <tr> <th colspan="3" style="background-color: #444; color: white;">AES 75</th> </tr> <tr> <th style="width: 15%;">Status</th> <th style="width: 45%;">Peak</th> <th style="width: 40%;">Direction</th> </tr> </thead> <tbody> <tr> <td>AES 75 Ch 1-2</td> <td>Present PCM</td> <td>-78 dBFS / -77 dBFS</td> </tr> <tr> <td>AES 75 Ch 3-4</td> <td>Absent</td> <td>---f---</td> </tr> <tr> <td colspan="3" style="text-align: center;">⋮</td> </tr> <tr> <td>AES 75 Ch 15-16</td> <td>Absent</td> <td>---f---</td> </tr> </tbody> </table> <table border="1" style="width: 100%; border-collapse: collapse;"> <thead> <tr> <th colspan="3" style="background-color: #444; color: white;">AES 110</th> </tr> <tr> <th style="width: 15%;">Status</th> <th style="width: 45%;">Peak</th> <th style="width: 40%;">Direction</th> </tr> </thead> <tbody> <tr> <td>AES 110 Ch 1-2</td> <td>Absent</td> <td>---f---</td> </tr> <tr> <td>AES 110 Ch 3-4</td> <td>Present</td> <td>-20 dBFS / -30 dBFS</td> </tr> <tr> <td colspan="3" style="text-align: center;">⋮</td> </tr> <tr> <td>AES 110 Ch 15-16</td> <td>Absent</td> <td>---f---</td> </tr> </tbody> </table>		Embedded			Status	Peak		Emb Ch 1-2	Present PCM	-78 dBFS / -77 dBFS	Emb Ch 3-4	Present PCM	-19 dBFS / -29 dBFS	Emb Ch 5-6	Present PCM	-34 dBFS / -39 dBFS	Emb Ch 7-8	Present PCM	0 dBFS / 0 dBFS	Emb Ch 9-10	Present PCM	-19 dBFS / -39 dBFS	Emb Ch 11-12	Present PCM	-34 dBFS / -29 dBFS	Emb Ch 13-14	Present PCM	-19 dBFS / -29 dBFS	Emb Ch 15-16	Present PCM	-34 dBFS / -39 dBFS	AES 75			Status	Peak	Direction	AES 75 Ch 1-2	Present PCM	-78 dBFS / -77 dBFS	AES 75 Ch 3-4	Absent	---f---	⋮			AES 75 Ch 15-16	Absent	---f---	AES 110			Status	Peak	Direction	AES 110 Ch 1-2	Absent	---f---	AES 110 Ch 3-4	Present	-20 dBFS / -30 dBFS	⋮			AES 110 Ch 15-16	Absent	---f---
Embedded																																																																			
Status	Peak																																																																		
Emb Ch 1-2	Present PCM	-78 dBFS / -77 dBFS																																																																	
Emb Ch 3-4	Present PCM	-19 dBFS / -29 dBFS																																																																	
Emb Ch 5-6	Present PCM	-34 dBFS / -39 dBFS																																																																	
Emb Ch 7-8	Present PCM	0 dBFS / 0 dBFS																																																																	
Emb Ch 9-10	Present PCM	-19 dBFS / -39 dBFS																																																																	
Emb Ch 11-12	Present PCM	-34 dBFS / -29 dBFS																																																																	
Emb Ch 13-14	Present PCM	-19 dBFS / -29 dBFS																																																																	
Emb Ch 15-16	Present PCM	-34 dBFS / -39 dBFS																																																																	
AES 75																																																																			
Status	Peak	Direction																																																																	
AES 75 Ch 1-2	Present PCM	-78 dBFS / -77 dBFS																																																																	
AES 75 Ch 3-4	Absent	---f---																																																																	
⋮																																																																			
AES 75 Ch 15-16	Absent	---f---																																																																	
AES 110																																																																			
Status	Peak	Direction																																																																	
AES 110 Ch 1-2	Absent	---f---																																																																	
AES 110 Ch 3-4	Present	-20 dBFS / -30 dBFS																																																																	
⋮																																																																			
AES 110 Ch 15-16	Absent	---f---																																																																	
<p>Channel-pair AES port user direction indicator/controls</p>																																																																			
<p>Note: Direction indicator/controls are ganged with same controls on Output Audio Routing page.</p>																																																																			

Table 3-1 9933-EMDE Function Menu List — continued

Output Audio Routing

Embedded
AES 75
AES 110

Provides source selection, gain, mute, and audio meters for embedded and AES destination (output) channels.

Input Audio Status
Output Audio Routing

Emb Out Ch 1	Emb Out Ch 2	Emb Out Ch 3	Emb Out Ch 4	Emb Out Ch 5	Emb Out Ch 6	Emb Out Ch 7	Emb Out Ch 8
AES 75 Ch 5	AES 75 Ch 6	AES 110 Ch 1	AES 110 Ch 2	Embedded Ch 5	Embedded Ch 6	Embedded Ch 7	Embedded Ch 8
Mute	Mute	Mute	Mute	Mute	Mute	Mute	Mute
20.0	20.0	20.0	20.0	20.0	20.0	20.0	20.0
-30.0	-30.0	-30.0	-30.0	-30.0	-30.0	-30.0	-30.0
-80.0	-80.0	-80.0	-80.0	-80.0	-80.0	-80.0	-80.0
0.0	0.0	0.0	0.0	0.0	0.0	0.0	0.0
Emb Out Ch 9	Emb Out Ch 10	Emb Out Ch 11	Emb Out Ch 12	Emb Out Ch 13	Emb Out Ch 14	Emb Out Ch 15	Emb Out Ch 16
Embedded Ch 9	Embedded Ch 10	Embedded Ch 11	Embedded Ch 12	Embedded Ch 13	Embedded Ch 14	Embedded Ch 15	Embedded Ch 16
Mute	Mute	Mute	Mute	Mute	Mute	Mute	Mute
20.0	20.0	20.0	20.0	20.0	20.0	20.0	20.0
-30.0	-30.0	-30.0	-30.0	-30.0	-30.0	-30.0	-30.0
-80.0	-80.0	-80.0	-80.0	-80.0	-80.0	-80.0	-80.0
0.0	0.0	0.0	0.0	0.0	0.0	0.0	0.0

Embedded
AES 75
AES 110

Card Embedded Audio Output

Output Audio crosspoints are available for embedded, AES 75 (AES-3id), and AES 110 (AES/EBU) output destination channels.

The example above shows various Source selections that direct various source choices to Emb Ch 1 thru Ch 16 destination output channels (unused channels can be set to Silence or Mute if desired).

Each output channel provides Gain and Mute controls as well as level meters. Several internal tones generator sources can also be routed to an output channel.

9933EMDE-75-110-OM (V1.1)

9933-EMDE16-75/110 PRODUCT MANUAL

3-9

Table 3-1 9933-EMDE Function Menu List — continued



<div style="background-color: #333; color: white; padding: 5px; text-align: center; font-weight: bold; font-size: 1.2em;">Output Audio Routing</div> <div style="display: flex; justify-content: space-around; margin-top: 5px;"> <div style="background-color: #ccc; padding: 2px 5px;">Embedded</div> <div style="background-color: #ccc; padding: 2px 5px;">AES 75</div> <div style="background-color: #ccc; padding: 2px 5px;">AES 110</div> </div>	<p>(continued)</p>
<p>Note:</p> <ul style="list-style-type: none"> • Default factory preset routing routes as pass-thru embedded Ch 1 thru Ch 16 to Emb Ch 1 thru Emb Ch 16. • Emb Ch 2 thru Emb Ch 16 have controls identical to the controls described here for Emb Ch 1. Therefore, only the Emb Ch 1 controls are shown here. 	
<p>• Embedded Audio Channel Source Select</p> 	<p>Using the Source drop-down list, selects the audio input source to be routed to the card bus channel from the following choices:</p> <ul style="list-style-type: none"> • Embedded input channel 1 thru 16 (Embedded Ch 1 thru Embedded Ch 16) • AES 75 (AES-3id) input channel 1 thru 16 (AES 75 Ch 1 thru AES 75 Ch 16) • AES 110 (AES/EBU) input channel 1 thru 16 (AES 110 Ch 1 thru AES 110 Ch 16) • Built-in Tone generators Tone 100 Hz thru Tone 16 kHz (all are -20 dBFS level; freq (Hz) in ascending order are 100, 200, 300, 400, 500, 600, 700, 800, 900, 1k, 2k, 4k, 6k, 8k, 12k, and 16k) • Silence <p>Note:</p> <ul style="list-style-type: none"> • AES pair sourcing is dependent on rear I/O module used. Current rear modules may not support full input complement. • AES pair selection should be boundary pairs applied to normal boundary pairs of embedded destinations.
<p>• Channel Mute/Gain Controls and Peak Level Display</p> 	<p>Provides Mute channel controls, as well as peak level meter for each output channel. (Meter shows level as affected by Level control.)</p> <p>Gain controls allow relative gain (in dB) control for the corresponding destination Embedded Audio Group channel.</p> <p>(-80 to +20 dB range in 1.0 dB steps; unity = 0 dB)</p> <p>Note: Although the card can pass non-PCM data such as Dolby® E or AC-3, setting the gain control to any setting other than default 0 will corrupt Dolby data.</p>

Table 3-1 9933-EMDE Function Menu List — continued

	<p>Provides source selection, gain, mute, and audio meters for AES 75 and AES 110 destination (output) channels.</p>
<p>Note: AES 75 Ch 2 thru Ch 16, and AES 110 Ch 1 thru Ch 16 have controls identical to the controls described here for AES 75 Ch 1. Therefore, only the AES 75 Ch 1 controls are shown here.</p>	
<p>• AES Pair Direction Select and Audio Channel Source Select</p> 	<p>Input (Output) buttons set an AES pair as an input or output (in this example, AES 75 pair 1/2 set as Output).</p> <p>Note: AES pair input/output selection also shown and controllable via similar controls on the Input Audio Status page.</p> <p>Using the Source drop-down list, selects the audio input source to be routed to the corresponding destination channel from the following choices:</p> <ul style="list-style-type: none"> • Embedded input channel 1 thru 16 (Embedded Ch 1 thru Embedded Ch 16) • AES 75 (AES-3id) input channel 1 thru 16 (AES 75 Ch 1 thru AES 75 Ch 16) • AES 110 (AES/EBU) input channel 1 thru 16 (AES 110 Ch 1 thru AES 110 Ch 16) • Built-in Tone generators Tone 100 Hz thru Tone 16 kHz (all are -20 dBFS level; freq (Hz) in ascending order are 100, 200, 300, 400, 500, 600, 700, 800, 900, 1k, 2k, 4k, 6k, 8k, 12k, and 16k) • Silence <p>Note:</p> <ul style="list-style-type: none"> • AES pair sourcing is dependent on rear I/O module used. Current rear modules may not support full input complement. • AES pair selection should be boundary pairs applied to normal boundary pairs of embedded destinations.
<p>• Channel Mute/Gain Controls and Peak Level Display</p> 	<p>Provides Mute channel controls, as well as peak level meter for each output channel. (Meter shows level as affected by Level control.)</p> <p>Gain controls allow relative gain (in dB) control for the corresponding destination AES channel.</p> <p>(-80 to +20 dB range in 1.0 dB steps; unity = 0 dB)</p> <p>Note: Although the card can pass non-PCM data such as Dolby® E or AC-3, setting the gain control to any setting other than default 0 will corrupt Dolby data.</p>

Troubleshooting

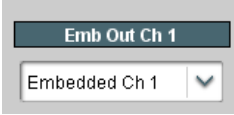
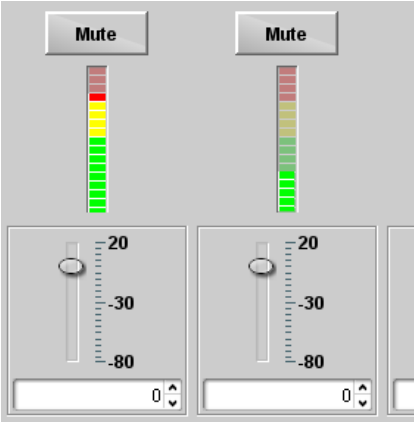
This section provides general troubleshooting information and specific symptom/corrective action for the 9933-EMDE card and its remote control interface. The 9933-EMDE card requires no periodic maintenance in its normal operation; if any error indication (as described in this section) occurs, use this section to correct the condition.

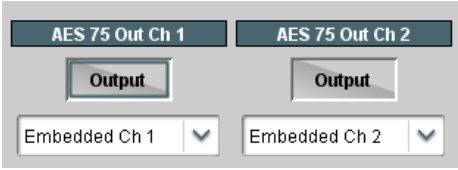
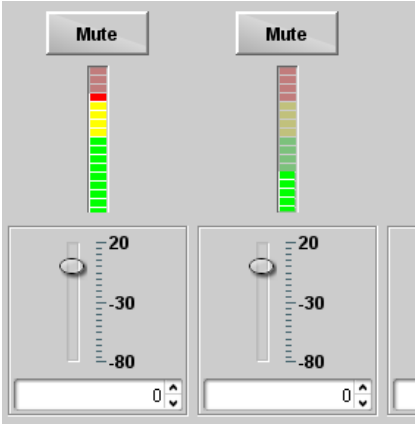
Error and Failure Indicator Overview

The 9933-EMDE card itself and its remote control systems all (to varying degrees) provide error and failure indications. Depending on how the 9933-EMDE card is being used (i.e., standalone or network controlled through DashBoard™ or a Remote Control Panel), check all available indications in the event of an error or failure condition. The various 9933-EMDE card and remote control error and failure indicators are individually described below.

Note: The descriptions below provide general information for the various status and error indicators. For specific failures, also use the appropriate subsection listed below.

- Basic Troubleshooting Checks (p. 3-15)
- 9933-EMDE Processing Error Troubleshooting (p. 3-15)
- Troubleshooting Network/Remote Control Errors (p. 3-16)

9933-EMDE Card Edge Status/Error Indicators and Display

Figure 3-4 shows and describes the 9933-EMDE card edge status indicators and display. These indicators and the display show status and error conditions relating to the card itself and remote (network) communications (where applicable). Because these indicators are part of the card itself and require no external interface, the indicators are particularly useful in the event of communications problems with external devices such as network remote control devices.

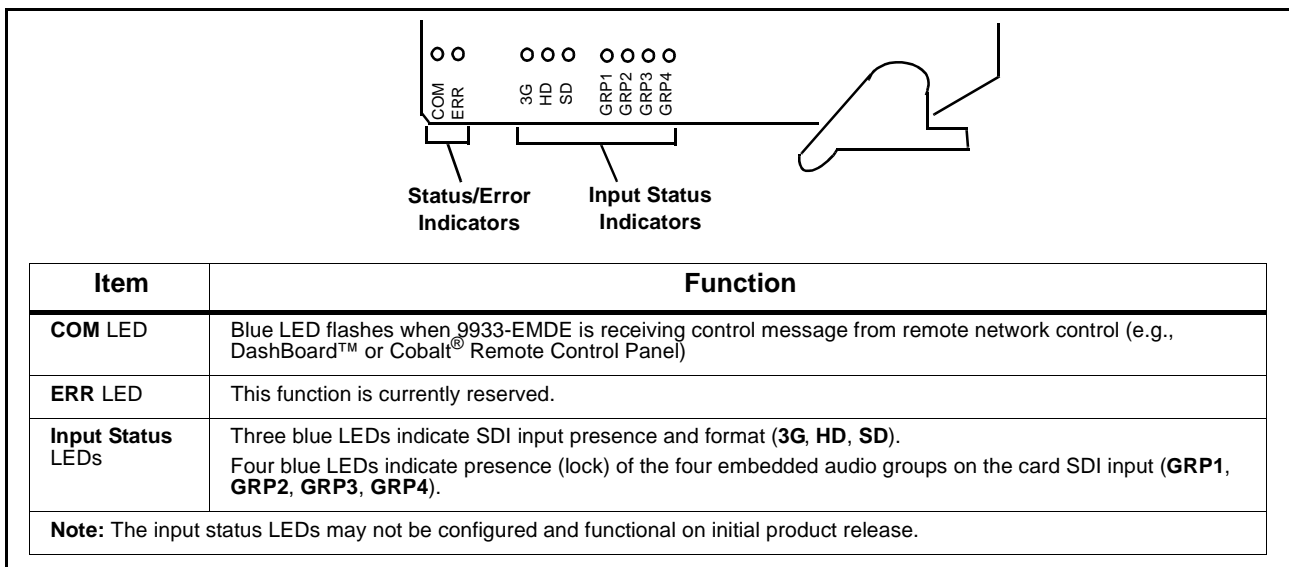

Figure 3-4 9933-EMDE Card Edge Status Indicators

DashBoard™ Status/Error Indicators and Displays

Figure 3-5 shows and describes the DashBoard™ status indicators and displays. These indicator icons and displays show status and error conditions relating to the 9933-EMDE card itself and remote (network) communications.

Indicator Icon or Display	Error Description
	<p>Red indicator icon in Card Access/Navigation Tree pane shows card with Error condition (in this example, the Card Access/Navigation Tree pane shows a general error issued by the 9933-EMDE card in slot 6).</p> <p>Specific errors are displayed in the Card Info pane (in this example “No connection to device” indicating 9933-EMDE card is not connecting to frame/LAN). If the 9933-EMDE card is not connecting to the frame or LAN, all controls are grayed-out (as shown in the example here).</p>
	<p>Gray indicator icon in Card Access/Navigation Tree pane shows card(s) are not being seen by DashBoard™ due to lack of connection to frame LAN (in this example, both a 9933-EMDE card in slot 6 and the MFC-8320-N Network Controller Card for its frame in slot 6 are not being seen).</p>
	<p>Yellow indicator icon in Card Access/Navigation Tree pane shows card with Alert condition (in this example, the Card Access/Navigation Tree pane shows a general alert issued by the MFC-8320-N Network Controller Card).</p> <p>Clicking the card slot position in the Card Access/Navigation Tree (in this example Network Controller Card “Slot 0: MFC-8320-N”) opens the Card Info pane for the selected card. In this example, a “Fan Door Open” specific error is displayed.</p>
	<p>Yellow indicator icon in 9933-EMDE Card Info pane shows error alert, along with cause for alert (in this example, the 9933-EMDE is not receiving a video input).</p>

Figure 3-5 DashBoard™ Status Indicator Icons and Displays

Access Card Info panes for specific cards by clicking the card slot position in the Card Access/Navigation Tree pane (as shown in the example in Figure 3-6).

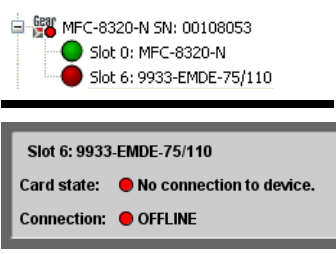
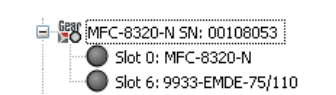
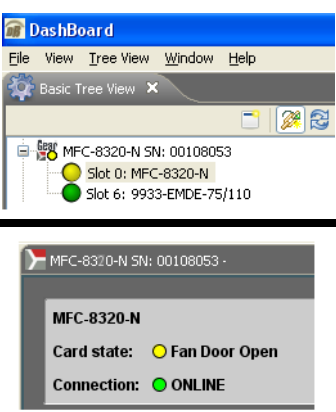
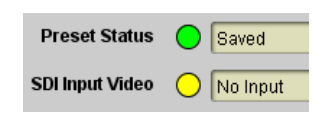
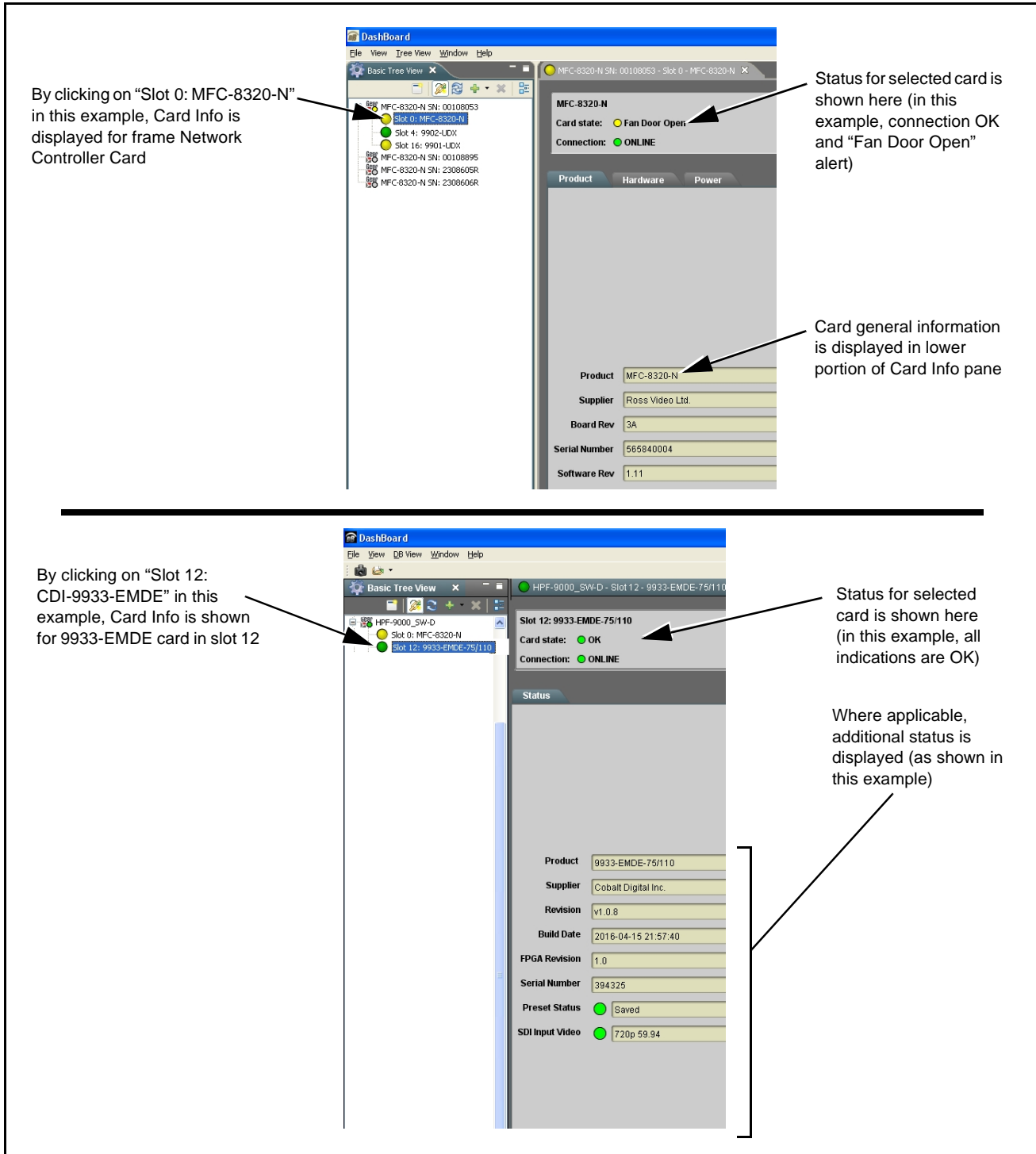

Figure 3-6 Selecting Specific Cards for Card Info Status Display

Basic Troubleshooting Checks

Failures of a general nature (affecting many cards and/or functions simultaneously), or gross inoperability errors are best addressed first by performing basic checks before proceeding further. Table 3-2 provides basic system checks that typically locate the source of most general problems. If required and applicable, perform further troubleshooting in accordance with the other troubleshooting tables in this section.

Table 3-2 Basic Troubleshooting Checks

Item	Checks
Verify power presence and characteristics	On both the frame Network Controller Card and the 9933-EMDE, in all cases when power is being properly supplied there is always at least one indicator illuminated. Any card showing no illuminated indicators should be cause for concern.
Check Cable connection secureness and connecting points	Make certain all cable connections are fully secure (including coaxial cable attachment to cable ferrules on BNC connectors). Also, make certain all connecting points are as intended. Make certain the selected connecting points correlate to the intended card inputs and/or outputs. Cabling mistakes are especially easy to make when working with large I/O modules.
Card seating within slots	Make certain all cards are properly seated within its frame slot. (It is best to assure proper seating by ejecting the card and reseating it again.)
Check status indicators and displays	On both DashBoard™ and the 9933-EMDE card edge indicators, red indications signify an error condition. If a status indicator signifies an error, proceed to the following tables in this section for further action.
Troubleshoot by substitution	All cards within the frame can be hot-swapped, replacing a suspect card or module with a known-good item.

9933-EMDE Processing Error Troubleshooting

Table 3-3 provides 9933-EMDE processing troubleshooting information. If the 9933-EMDE card exhibits any of the symptoms listed in Table 3-3, follow the troubleshooting instructions provided.

In the majority of cases, most errors are caused by simple errors where the 9933-EMDE is not appropriately set for the type of signal being received by the card.

- Note:**
- The error indications shown below are typical for the corresponding error conditions listed. Other error indications not specified here may also be displayed on DashBoard™ and/or the 9933-EMDE card edge status indicators.
 - Where errors are displayed on both the 9933-EMDE card and network remote controls, the respective indicators and displays are individually described in this section.

Table 3-3 Troubleshooting Processing Errors by Symptom

Symptom	Error/Condition	Corrective Action
<ul style="list-style-type: none"> DashBoard™ shows Unlocked message in 9933-EMDE Status pane  <ul style="list-style-type: none"> Card edge Input LED corresponding to input is not illuminated 	No video input present	Make certain intended video source is connected to appropriate 9933-EMDE card video input. Make certain BNC cable connections between frame Rear I/O Module for the card and signal source are OK.
Audio not processed or passed through card	AES port not set as input or output as intended	On Input Audio Status or Output Audio Routing tab, make certain port direction setting matches desired direction.
Dolby audio corrupted or unrecognized by downstream device	Audio Output Routing Gain control(s) for port set to setting other than unity gain (0.0 dB)	Although the card can pass non-PCM data such as Dolby® E or AC-3, setting the gain control to any setting other than default 0 will corrupt Dolby data.

Troubleshooting Network/Remote Control Errors

Refer to Cobalt® reference guide “Remote Control User Guide” (PN 9000RCS-RM) for network/remote control troubleshooting information.

In Case of Problems

Should any problem arise with this product that was not solved by the information in this section, please contact the Cobalt Digital Inc. Technical Support Department.

If required, a Return Material Authorization number (RMA) will be issued to you, as well as specific shipping instructions. If required, a temporary replacement item will be made available at a nominal charge. Any shipping costs incurred are the customer’s responsibility. All products shipped to you from Cobalt Digital Inc. will be shipped collect.

The Cobalt Digital Inc. Technical Support Department will continue to provide advice on any product manufactured by Cobalt Digital Inc., beyond the warranty period without charge, for the life of the product.

See Contact Cobalt Digital Inc. (p. 1-10) in Chapter 1, “Introduction“ for contact information.



Cobalt Digital Inc.

2506 Galen Drive
Champaign, IL 61821
Voice 217.344.1243 • Fax 217.344.1245
www.cobaltdigital.com