



Connect with Confidence

# ***MultiView*** ***AK1200*** **Receiver**

Quick Reference  
&  
Setup Guide



## **Magenta Research**

128 Litchfield Road, New Milford, CT 06776 USA  
(860) 210-0546 FAX (860) 210-1758  
[www.magenta-research.com](http://www.magenta-research.com)

## MAGENTA MULTIVIEW™ SERIES

© 1998-2009 by Magenta Research All rights reserved.

Magenta Research  
128 Litchfield Road  
New Milford, CT 06776 USA

This document and the Magenta Research products to which it relates, and the copyright in each, is the property of Magenta Research. Neither the document nor the products may be reproduced by any means, in whole or in part, without the prior written permission of Magenta Research. Magenta Research makes no warranty or representation, either express or implied, with respect to this software or documentation, including their quality, performance, merchantability, or fitness for a particular purpose. As a result, this software or documentation are licensed "as is" and you, the licensee, are assuming the entire risk as to their quality and performance.

In no event will Magenta Research be liable for direct, indirect, special, incidental, or consequential damages arising out of the use of or inability to use the software or documentation.

*Magenta Research and the Magenta Research logo are trademarks of Magenta Research.  
All other brands, product names, and trademarks are the property of their respective owners.*

### FEDERAL COMMUNICATIONS COMMISSION AND INDUSTRY CANADA RADIO FREQUENCY INTERFERENCE STATEMENTS

This equipment generates, uses, and can radiate radio-frequency energy, and if not installed and used properly, that is, in strict accordance with the manufacturer's instructions, may cause interference to radio communication. It has been tested and found to comply with the limits for a Class A computing device in accordance with the specifications in Subpart B of Part 15 of FCC rules, which are designed to provide reasonable protection against such interference when the equipment is operated in a commercial environment. Operation of this equipment in a residential area is likely to cause interference, in which case the user at his own expense will be required to take whatever measures may be necessary to correct the interference.

Changes or modifications not expressly approved by the party responsible for compliance could void the user's authority to operate the equipment.

*This digital apparatus does not exceed the Class A limits for radio noise emission from digital apparatus set out in the Radio Interference Regulation of Industry Canada.*

### EUROPEAN UNION DECLARATION OF CONFORMITY

The manufacturer declares that this product meets the requirements of EU Directive 89/336/EEC.



# Contents

Chapter	Page
1. Specifications.....	2
2. Introduction .....	3
2.1 Overview.....	3
2.2 Equipment You May Also Need.....	3
2.3 Compatible Cabling .....	3
3. Setup and Installation.....	4
3.1 Data Mode Configuration.....	4
3.2 Cabling Considerations.....	4
3.3 Making the Connections.....	4
3.3.1 Connections and Setup in General .....	4
3.3.2 Connections on the Single-Port VGA/Audio.....	5
3.3.3 Connections on the Single-Port RS232 version.....	6
3.3.4 Connections on the Single-Port SA/SAP version.....	7
3.4 Video Adjustment.....	8
3.4.1 Cable Distance Compensation Settings.....	8
3.4.2 Skew Compensation Settings.....	9
4. Troubleshooting.....	10
4.1 Common Problems .....	10
Appendix A. Cabling Pinouts.....	12
Appendix B. AK1200 Configuration Settings.....	14
Appendix C. Serial Daughterboards.....	16
Appendix D. Setting Sync Modes.....	18
Appendix E. Skew Module.....	19
Appendix F. Mounting Options.....	20
Appendix G. Pollable Serial Mode.....	21

# 1. Specifications

**Cable Required:** Category 5, 5e, 6 shielded or unshielded twisted pair

**Compliance:** CE; FCC Class A, IC Class A

**Video Support:** all supported VESA modes to WUXGA (1920x1200), RGBHV, RGB, Composite (NTSC, PAL, SECAM), S-Video, Component Video, widescreen modes, HDTV modes including 1080p, 1080i, 720p

## Resolution and

**Refresh Rate:** At 1200 ft. (366 m) or less: a maximum of 1920x1200

## Required Source

**Impedance:** Video OUT: 75 ohms;  
Audio models: Audio OUT (if any): 600 ohms maximum  
SPDIF audio models: 75 Ohm.

## Required Destination

**Impedance:** Video IN: 75 ohms;  
Audio models: Audio IN (if any): 600 ohms minimum  
SPDIF audio models: 75 Ohm.

## Audio

**Characteristics:** Right/Left summed ("A" option)  
SA/SAP: Full Stereo  
Line Level 600 Ohm Unbalanced

## Serial

**Characteristics:** Protocol: Asynchronous; transparent to data format;  
transparent to data rates up to 19.2 kbps full duplex;  
data rates to 115 kbps simplex, half-duplex modes  
SA version is 3 wire, fixed baud rate of 9600

**Connectors:** (1) 4 pin phoenix, (2) RJ-45, (1) HD15 F; (1) DB9M (model dependent)

## Temperature

**Tolerance:** Operating: 32 to 104°F (0 to 40°C);  
Storage: -4 to +140°F (-20 to +60°C)

## Humidity

**Tolerance:** Up to 80% noncondensing

**Enclosure:** Steel

**Power:** +5 VDC  
Consumption: 6 watts maximum

**Size:** 1.2"H x 3.6"W x 5.5"D (3.0 x 9.2 x 14.0 cm)

**Weight:** 1.0 lb. (0.45 kg)

## 2. Introduction

### 2.1 Overview

The Magenta MultiView Series extends video, audio and serial signals over ordinary Category 5 cable.

This manual covers Magenta MultiView Series AK1200 Receivers. These units are field configurable for various video, audio and serial options. See Appendix B for configuration settings.

232 versions support full modem RS232 serial signals with the video.

SA series feature video, stereo audio and RS-232 signals on a single cat5.

SAP series units are similar to the above but have additional features for pollable serial.

The Magenta MultiView Series AK1200 Receivers feature optional integrated skew compensation that can be varied in 2 ns increments to 65 ns total per color channel to cancel the effects of skew in Category cables. This feature allows you to use CAT5e and reduced-skew CAT6 cables to lengths up to 1200 ft.

For information on the respective transmitter unit, please refer to the appropriate manual included with the transmitter.

All models support refresh rates/resolutions up to 1920 x 1200 to 1200 feet.

### **WARNING**

**This equipment is not intended for, nor does it support, distribution through an Ethernet network. Do not connect these devices to any sort of networking or telecommunications equipment!**

### 2.2 Equipment You May Also Need

- Audio cable with RCA jacks.
- Video cable with HD15 connectors
- Serial cable with DB9 connectors.
- CAT5 cable.

### 2.3 Compatible Cabling

Magenta Research products are compatible with Cat5/5e/6 data cabling as well as skew free CAT5/5e cabling manufactured for video applications. Note that some skew free Cat5 is specific to a particular vendor and is not compatible with our products. Please ensure any skew free CAT5 cable is non-proprietary prior to purchase/ installation.

CAT6 cable, due to the manufacture method, can exhibit much greater skew than standard CAT5/5e and may require skew compensation beyond what the standard product offers. Please contact Magenta Research for assistance.

CAT5/5e/6 cabling for the Magenta MultiView Series must be pinned to the TIA-EIA T568B wiring specification (see appendix A) We also highly recommend that all CAT5 cables be pre-terminated and tested. Cables terminated on-site or in an existing infrastructure should be tested before use to ensure compliance with the TIA-EIA T568B specification. Using incorrectly terminated CAT5 cables can damage the Magenta MultiView Series.

## 3. Setup and Installation

### 3.1 Data Mode Configuration

AK1200 232 serial receivers are configured in full modem bidirectional serial modes. If you are using the daisy chain option or a multi-output transmitter (T4,T5) a MultiView™ CAT5 matrix switch or MultiView™ CAT5 distribution amp, this mode must be changed to uni-directional broadcast. To do this, configure the internal Serial Digital Board (SDB) to change the transmitters & receivers serial mode operation (See **Appendix C**). This configuration should be done before making any cable connections and applying power.

Alternatively, remove the internal daughterboard and use the AK1200 receivers built in simplex serial option with the appropriate jumper changes.

SA series offer RS232 serial in addition to stereo audio. The serial signal is 3 wire TX, RX, GND and does not support full modem signals. Baud rates for the SA series are fixed at 9600. Simplex modes are supported without jumper or other changes by simply using the TX signal only. SA units require no configuration.

SAP series offer pollable RS232 serial in addition to stereo audio. The serial signal is 3 wire TX, RX, GND and does not support full modem signals. Baud rates for the SAP series are fixed at 9600. Simplex modes are supported without jumper or other changes by simply using the TX signal only. See Appendix G on configuration and use of SAP Series.

### 3.2 Cabling Considerations

- We recommend mounting and connecting all cabling to the Magenta MultiView Series components before applying power.
- Makes sure that the CAT5 cable you intend to use has been tested to comply with the TIA/EIA 568B wiring specification (See **Appendix A**).

### 3.3 Making the Connections

#### 3.3.1 CONNECTIONS AND SETUP IN GENERAL

This section contains figures showing connections with the specific Magenta MultiView Series models. In general, however, the connection and setup procedure at both transmitter and receiver ends is as follows:

*NOTE: all units must be the same type for all supported features to function correctly. For example, a UTX set for R/L summed audio must be connected to an AK1200 set for R/L summed audio. Similarly, a UTX SA cannot be used with an AK1200. Video modes may function normally, but 4th pair options will not.*

*At the transmitter end (refer to the transmitter user guide) :*

1. Connect the source video to the Magenta MultiView Series transmitter video input port, which is an HD15 connector labeled SOURCE IN or VIDEO IN.
2. If desired, attach a local monitor via the local monitor port to LOCAL OUT
3. Make your audio or serial connections via the phoenix connector or DB9 connector as appropriate.

4. Connect the CAT5 cable to the transmitter.
5. Apply power on the transmitter. The LED should light and, if there's a local monitor attached, a video image should appear on the monitor's screen.

*At the receiver end:*

1. Connect the VIDEO OUT HD15 connector to the display unit, and attach any audio (AUX I/O) or serial connections (IOIO) depending on the model of MultiView CAT5 Video System.
2. Connect the CAT5 cable to the LINK INPUT connection. If daisy chaining units, connect the output CAT5 cable to the LINK OUTPUT connection.
3. Apply power. The LED should light and video should appear on the display (make sure display is powered ON).
4. To adjust video levels and skew compensation see **Section 3.4**.
5. Please mount the AK1200 in a location that ensures the ventilation holes and fan are not blocked.

**3.3.2 CONNECTIONS ON THE SINGLE-PORT VGA/AUDIO**

The single-port units with audio support video and audio signals over CAT5 cable. The audio signal is line-level summed Right/Left audio, and powered speakers are required. You can also use the transmitters and receivers to make video-only connections without audio. Figure 3-1 shows the Single-Port MultiView CAT5 Video System with Audio Transmitter connections, and Figure 3-2 shows the receiver connections.

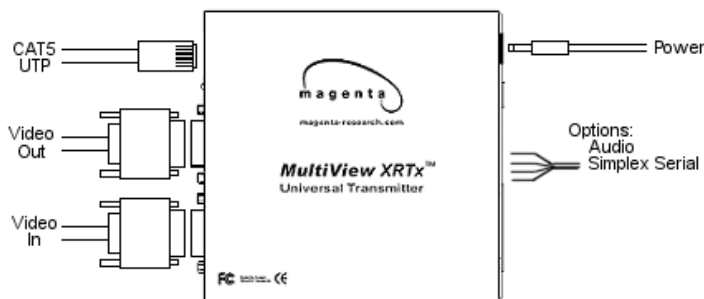

**Figure 3-1. Connections on the XRTx Universal Transmitter.**

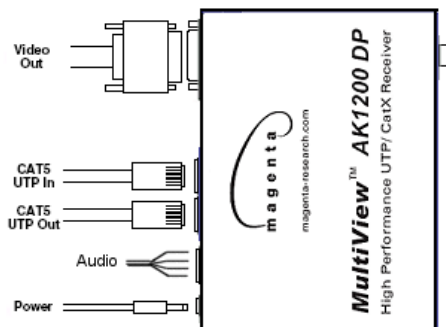

**Figure 3-2. Connections on the AK1200 for video and audio.**

## MAGENTA MULTIVIEW™ SERIES

### 3.3.3 CONNECTIONS ON THE SINGLE-PORT VGARS-232

The Single-Port MultiView™ CAT5 Video System with RS-232 supports video and full-modem serial (RS-232) signals over CAT5 cable. You can also use the transmitters and receivers to make video-only connections without serial communications. Figure 3-3 shows the Single-Port MultiView™ CAT5 Video System with RS-232 Transmitter connections, and Figure 3-4 shows the receiver connections.

#### NOTE

Even though both transmitter and receiver units contain audio jacks, audio is not supported on the RS-232 version. Plugging in audio cables may interfere with the RS-232 serial communications.

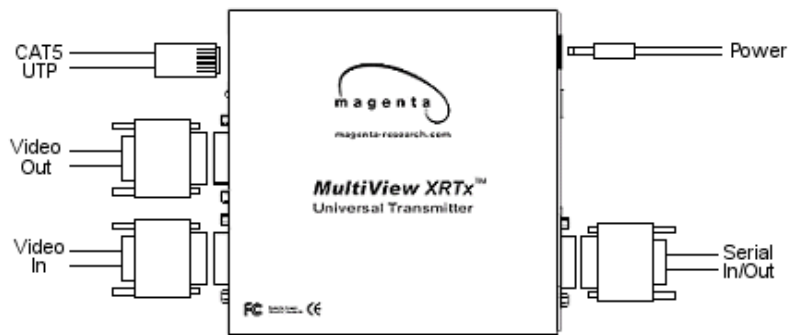

Figure 3-3. Connections on the XRTx 232 Universal Transmitter.

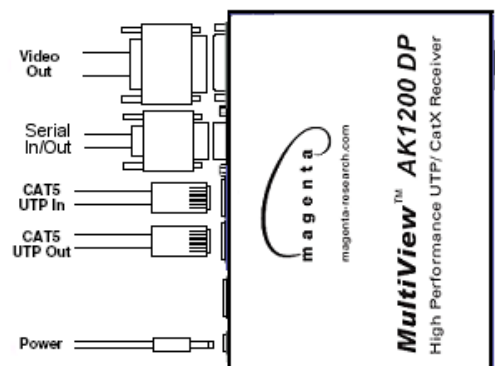

Figure 3-4. Connections on the AK1200 232 Receiver



3.3.4 CONNECTIONS ON THE SINGLE-PORT VGA SA and SAP

The Single-Port MultiView™ CAT5 Video System SA/SAP series supports RS-232, video and stereo audio signals over CAT5 cable. SAP offers pollable serial modes so a bi-directional serial session can be established with a receiver in a daisy chain. The Magenta MultiView T4, T5 transmitters do not support SA/SAP versions.

In order to utilize the full potential of the Magenta MultiView SA/SAP series, all transmitters and receivers must be SA/SAP versions.

You cannot connect a standard RS232 or L/R audio version to an SA/SAP version to get a single serial or audio signal. Video modes are not affected by this.

Serial signals are 3 wire RS232 (Tx, Rx, ground) and fixed at 9600 baud. Full 9 pin modem signals are not supported.

Note when using the Magenta MultiView SA/SAP series with a MultiView 9D Cat5 DA, or Cat5 matrix switch, the serial is transmit only. There are no configuration changes required to the units. The serial application in use should be changed to transmit only.

Audio is full stereo, line level. One or two separate channels of mono audio may also be used.

See figures below for cabling connections.

Appendix G details the configuration and use of the SAP series.

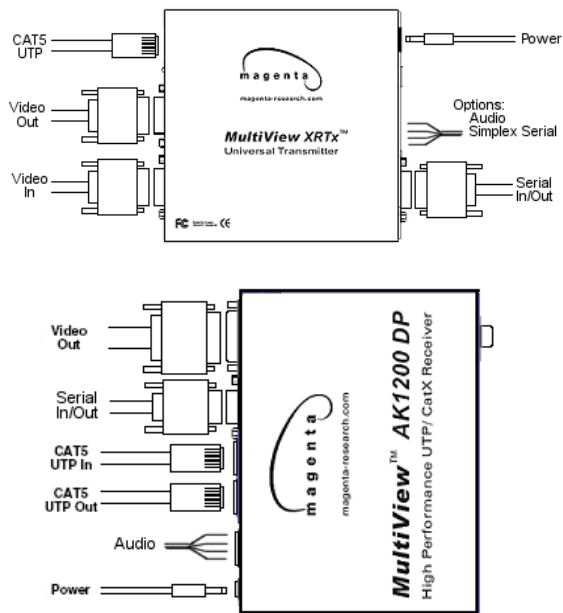

Figure 3-5: SA & SAP connections

**NOTE**

*SA units are pre-configured from the factory and require no configuration changes. SAP Units require unique addresses when pollable serial is used. See Appendix G.*

### 3.4 Video Adjustment

#### 3.4.1 Cable Distance Compensation Settings

In order to get the highest quality video signals from your MultiView CAT5 Video System, please follow the instructions and diagrams below:

An Image Adjustment Utility is available for download from:

[http:// www.magenta-research.com/test](http://www.magenta-research.com/test)

Simply open in any image browser on a computer.

If the image file can not be downloaded, use a utility to draw a black box on a white background.

**NOTE: TURN KNOB SLOWLY DURING ADJUSTMENT PROCEDURE. Turning too fast may result in missing the proper EQ setting resulting in picture loss.**

**To Reset EQ and Skew values to 0, remove power from AK1200, Push and hold EQ/Skew Knob in and re-apply power.**

1. Push EQ/Skew knob in once so that the R/G/B LED is white.
2. Turn the EQ/Skew knob clockwise until the shadow next to the black box just disappears. The brightness in the white area should be the same as the white area above and below the black box. The Cable Length LEDs will turn on for indicated cable distances. Starting from zero feet to 1,200 may take some time. Please continue turning the knob for best picture quality.
3. Press and release EQ/Skew knob until the R/G/B LED is off.

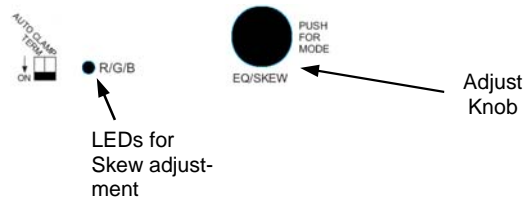

Figure 3-6: Adjustment locations

#### Distance Compensation Setting Utility

Adjust Cable Compensation control to obtain a minimum shadowing effect in the white area to the right of the black window

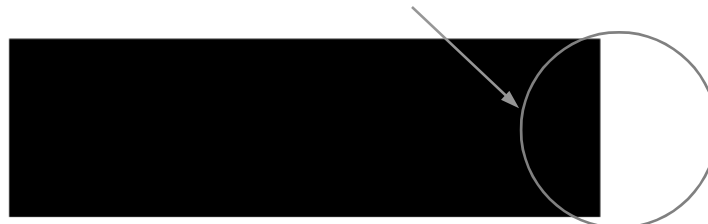

Figure 3-7: Image Adjustment Utility—Cable Length EQ

### 3.4.2 Skew Compensation Settings

The AK1200 receiver is available with an optional skew compensation module to adjust for signal timing differences due to differing pair lengths within the CAT5 cable. Using the delay signals, skew may be compensated from 2 to 65 nanoseconds in 2 nanosecond increments on each individual color pair.

If skew compensation is required, but the skew comp module is not installed, call for technical assistance.

An image file is available to assist in these settings (see Section 3.4.1 for details). See Figure 3-8 for an example.

1. To adjust individual colors, press the EQ/Skew knob until the desired color LED is on for the R/G/B LED. The LED color corresponds to the color channel being adjusted.
2. Using the image utility, turn knob to add/subtract delay timing until a single vertically aligned line of red, green, blue is obtained.
3. When complete press EQ/Skew knob until R/G/B LED is off.

Not all colors will have the same delay settings.

#### Cable Skew Compensation Setting Utility

Adjust skew equalizer to align Red, Green and Blue lines so they are stacked one on top of the other. Next, check white and black lines. Make fine adjustments until there is a minimum of color fringing.

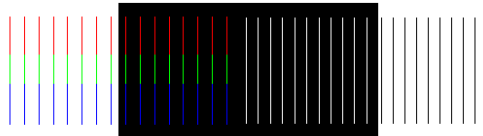

Figure 3-8: Image Adjustment Utility—Skew

## 4. Troubleshooting

### 4.1. Common Problems

In most cases, nearly every issue with the MultiView CAT5 Video System can be resolved by checking the CAT5 termination and making sure that it's pinned to the TIA/EIA 568B wiring specification. However, there may be other problems that cause the system to not perform as it's designed. Below are solutions to the most common installation errors.

- Problem:** No video signal at the transmitter local port or at the receiver.  
**Solution:**
- Check that both units are powered.
  - Ensure EQ adjustment is set correctly — turn knob slowly.
  - Make sure the CAT5 cable is terminated correctly per the TIA/EIA 568B wiring specification.
  - Is the display device powered on and functioning? Check to ensure display settings (resolution, refresh rate, etc) are compatible with input signal.
- Problem:** Poor video quality:  
**Solution:**
- Have all receiver adjustments been finished (see section 3.4).
  - Ensure EQ adjustment is set correctly — turn knob slowly.
  - Check all cable connections.
  - The video signal's refresh rate may be set too high. Reset to a lower refresh rate in your monitor-configuration menu.
  - There may be a delay skew issue. See Section on Skew.
- Problem:** Poor audio quality:  
**Solution:**
- Powered speakers are required. Make sure speaker power is ON.
  - Check input source levels from the source device. Make sure the audio source is not overdriven or underdriven.
  - Audio is summed left and right for "A" versions. If using a single channel, both audio inputs must be connected at the transmitter end for full audio gain. Audio is line level.
  - If Daisy Chaining, audio termination must be removed in DP units. Only the last receiver requires termination. Set the external TERM switch to ON/OFF as required. This does not apply to SA or SAP units (SA units no longer require separate daisy chain or end of line units as of April 2009).

**Problem:**  
**Solution:**

See  
 • Are  
 par  
 • Are  
 cab  
 • Wh  
 Ca  
 tra  
 mo  
 Sys  
 • The  
 mu  
 See  
 • SA  
 (TX)

**Problem:**  
**Solution:**

“Gre  
 The s  
 coup  
 Near  
 Some  
 can o  
 sync  
 mode  
 For fi  
 Multi  
 with t  
 via a  
 the X

**Problem:**  
**Solution:**

**Note**  
 When  
 beyo  
 AK60  
 It is p  
 rang  
 AK60  
 chain

- I
- n
- c
- V
- c
- V
- c
- s
- v
- c

Serial communication doesn't work correctly.

Are the serial devices connected properly? Are the serial parameters correct for source/destination devices?

Are the serial cables terminated correctly? If a null-modem cable is used, it must be placed at the receiver end.

When using RS-232 transmitters or receivers in daisy chains,

CAT5 switches, Cat5 distribution amps, or multi-output

transmitters, the serial signal is a unidirectionally broadcast

mode only. In this mode, all other MultiView™ CAT5 Video

system devices must be the simplex serial type.

The last device in a T4 transmitter or daisy chain configuration

must be a receiver unit with a terminated serial board.

See Appendix C for Serial board settings.

SAP units have a fixed baud rate of 9600 bps and use 3 wire

(TX, RX, GND) signals only.

When you see a "green shift" or "green washout" on multimedia signals.

The standard video/serial model is designed to function with DC

coupled signals in which the black level is referenced to 0 volts.

Mostly all VGA cards function this way.

Some media servers, however, provide AC coupled signals and

cause a green color shift in the video. This is a result of the

clamping on the red and blue channels of the video/serial

signal.

When using three-component (RGB/H&V) AC coupled video, the

MultiView CAT5 XRTx Universal transmitter has been designed

with full DC restoration capability. This problem is easily solved

with a simple switch setting in the XRTx Transmitter. Please refer to

the XRTx Transmitter user manual.

### Notes on Daisy Chaining:

In daisy chaining, the maximum cable distance is not increased

beyond the rated distance of the receiver used. For example, an

AK1200 can only daisy chain within 600 ft of the transmitter.

It is possible to daisy chain out of a short range receiver into a longer

range receiver to increase the range. For example, over 600 ft an

AK1200 can be daisy chained into an AK1200 which allows for daisy

chaining to 1,200 ft.

When using L/R summed audio, simplex serial, or SPDIF units a

maximum of 12 units may be daisy chained within the rated

cable length of the receiver.

When using SA units, a maximum of 4 units may be daisy

chained within the rated cable length of the receiver.

When using SAP units, a maximum of 12 units may be daisy

chained within the rated cable length of the receiver if using

standard cat5/6 or a maximum of 8 units may be daisy chained

within the rated cable length of the receiver if using skew-free

cable

## Appendix A. Cabling Pinouts

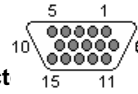

Table A-1. HD15 video connect

Pin	RGBHV (VGA)	RGBS	RGsB	Composite	SVHS (Y/C)	YUV
1	Red +	Red +	Red +		C+	V+
2	Green+	Green+	Green+	C+	Y+	Y+
3	Blue+	Blue+	Blue+			U+
4	—	—	—			
5	Gnd	Gnd	Gnd			
6	Red-	Red-	Red-		C-	V-
7	Green-	Green-	Green-	C-	Y-	Y-
8	Blue-	Blue-	Blue-			U-
9	—	—	—			
10	Gnd	Gnd	—			
11	Gnd	Gnd	—			
12	—	—	—			
13	H Sync	C Sync	—			
14	V Sync	—	—			
15	Gnd	Gnd	—			

Table A-2. Phoenix Connection

<u>PIN</u>	<u>Audio</u>	<u>SA / SAP Audio*</u>	<u>Simplex Serial</u>	<u>SPDIF Audio</u>	<u>Composite Video</u>
<b>Pin 1</b>	Left Channel	Right Channel	Tx	Signal +	Signal +
<b>Pin 2</b>	Ground	Ground	ground	Signal -	Signal -
<b>Pin 3</b>	Right Channel	Left Channel	-	-	-
<b>Pin 4</b>	-	-	Shell	-	-

**Note:** Typically Channel 1 is left audio and Channel 2 is right audio.

\*SA series RECEIVER units use Channel 1 for Right audio and channel 2 for Left audio.

\*SA series TRANSMITTER units use Channel 2 for Right audio and channel 1 for Left audio.

## Appendix A. Cabling Pinouts

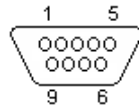
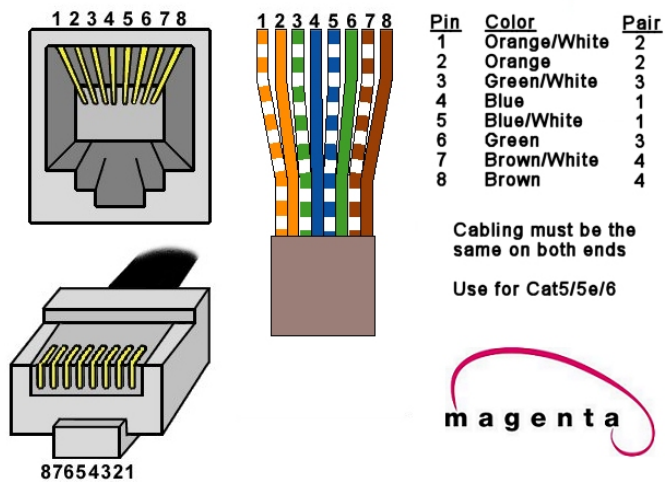

Table A-3. DB9 Male Serial connector

Pin	Full Duplex	3 wire (SA/SAP)	Simplex
1	DCD		
2	RX	RX	
3	TX	TX	TX
4	DTR		
5	Ground	Ground	Ground
6	DSR		
7	RTS		
8	CTS		
9	RI		

Table A-4. T568B CAT5 pinout

### T568B CAT5 Specification



## Appendix B. AK1200 Configuration Settings

Note: AK1200 receivers are typically pre-configured at time of order and will have factory configuration indicated on the bottom of the unit.

The factory configuration may be changed or checked by using the following jumper location diagram as well as Table B-1 for jumper settings.

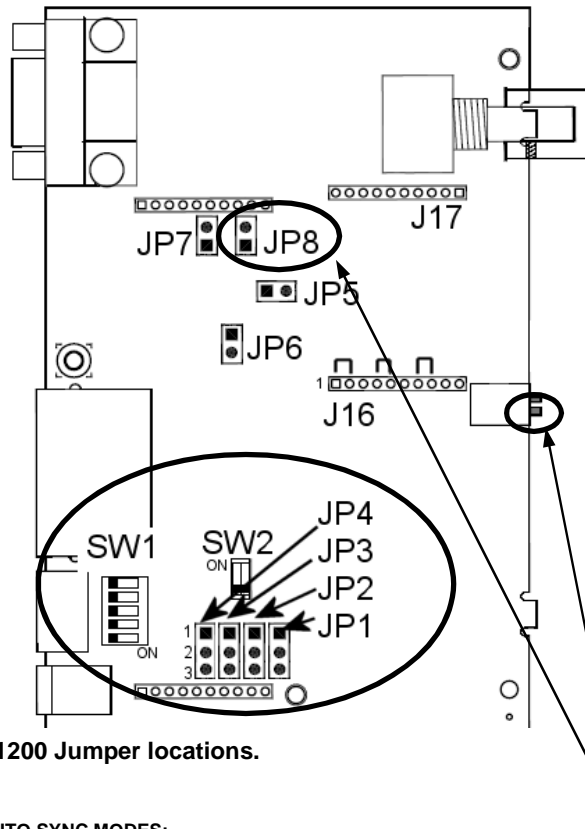

Figure B-1. AK1200 Jumper locations.

**AUTO SYNC MODES:**

JP8 controls sync clamping circuitry and works with the external switch labeled AUTO CLAMP.

The default sync mode is AUTO CLAMP OFF which will autosense between RGBHV and non-RGBHV signals.

Turning the External AUTO CLAMP switch ON will set the sync clamp mode to RGBHV video modes

If non-RGBHV video is desired with AUTO CLAMP ON, jumper JP8 must be set to IN.



## APPENDIX B: AK1200 Configuration Settings

Table B-1: MultiView AK1200 Configuration Jumper Settings											
Configuration Option (all options utilize 4th pair):	JP1	JP2	JP3	JP4	SW1					SW2	
					1	2	3	4	5	1	2
<b>RGBHV Computer Video (see note below on daisy chaining)</b>											
With Left/Right Line Level Audio	1-2	1-2	1-2	1-2	OFF	ON	ON	OFF	OFF	OFF	OFF
With SDPIF Digital Audio	1-2	1-2	1-2	1-2	OFF	ON	OFF	OFF	OFF	OFF	ON
With Simplex Serial (receive only)	1-2	1-2	1-2	1-2	ON	OFF	OFF	OFF	OFF	ON	OFF
With Composite Video	1-2	1-2	1-2	1-2	OFF	ON	OFF	OFF	OFF	OFF	ON
With RS 232 serial or SA/SAP series (requires separate daughterboard installed) Also set External TERM switch to OFF.	2-3	2-3	2-3	2-3	OFF	OFF	OFF	OFF	OFF	OFF	OFF
<b>Composite, S-Video, Component Video (see note below on daisy chaining)</b>											
With Left/Right Line Level Audio	1-2	1-2	1-2	1-2	OFF	ON	ON	OFF	OFF	OFF	OFF
With SDPIF Digital Audio	1-2	1-2	1-2	1-2	OFF	ON	OFF	OFF	OFF	OFF	ON
With Simplex Serial (receive only)	1-2	1-2	1-2	1-2	ON	OFF	OFF	OFF	OFF	ON	OFF
With Composite Video	1-2	1-2	1-2	1-2	OFF	ON	OFF	OFF	OFF	OFF	ON
With RS 232 serial or SA/SAP series (requires separate daughterboard installed) Also set External TERM switch to OFF.	2-3	2-3	2-3	2-3	OFF	OFF	OFF	OFF	OFF	OFF	OFF
<b>Daisy Chain Settings</b>											
* For END OF LINE Units, use configuration above, but set the external TERM switch to ON. This DOES NOT apply to 232, SA or SAP units	*	*	*	*	*	*	*	*	*	*	*
*Middle daisy chain units, use configuration above, but set the external TERM switch to OFF. This DOES NOT apply to 232, SA or SAP units	*	*	*	*	*	*	*	*	*	*	*

## Appendix C. Serial Daughterboard (SDB) Settings

The single-port serial transmitters and single-port and dual daisy chainable serial receivers contain an internal serial daughterboard (SDB) that can be configured for various serial modes. Multi Port Cat5 transmitters do not utilize the SDB and are configured for Mode 1 only.

The SDB hardware configuration is done via jumper settings. These jumpers are used to set the various modes of operation. As shown below. Both ends must be set the same.

To access the SDB on transmitters and receivers:

1. Make sure the unit is powered OFF
2. If necessary, unplug all cables to the unit.
3. Unscrew the top screw as well as the two set screws in the DB9 connector. Lift the cover off

Table C-1 shows the **Transmitter SDB** configuration settings.

Mode	Type	Baud (Max)	JP1 1-2	JP1 3-4
1	Simplex (one way) (to 1500 ft)	115k	OUT	IN
2	Full Duplex (2 way) Short (< 500 ft)	19.2K	OUT	OUT
3/5 Default Setting	Full Duplex (2 way) Long (to 1500 ft)	19.2k	IN	OUT
4	Half Duplex (2 way) Long (to 1500 ft)	115k	IN	IN

### Notes:

- **Mode 1 is required when using multi output transmitters and when daisy chaining receivers.**
- **Mode 3 may introduce noise in video over 1,000 ft when serial communication occurs. This does not apply when mode 5 is used on the receiver.**
- **JP1 5-6 and 7-8 terminate the serial bus and must be IN on the transmitter.**

## Appendix C. Serial Daughterboard (SDB) Settings, cont

Table C-2. Receiver SDB jumper settings

Mode	Type	Baud (Max)	JP1	JP2
1	Simplex (one way) (to 1500 ft)	115k	1-2 See Notes 3-4 See Notes 5-6 IN 7-8 OUT 9-10 OUT	1-2 IN 3-4 OUT 5-6 OUT 7-8 OUT 9-10 IN
2	Full Duplex (2 way) Short (< 500 ft)	19.2K	1-2 See Notes 3-4 See Notes 5-6 OUT 7-8 OUT 9-10 OUT	1-2 IN 3-4 OUT 5-6 OUT 7-8 IN 9-10 OUT
3	Full Duplex (2 way) Long (to 1000 ft)	19.2k	1-2 See Notes 3-4 See Notes 5-6 OUT 7-8 IN 9-10 OUT	1-2 IN 3-4 OUT 5-6 OUT 7-8 IN 9-10 OUT
4	Half Duplex (2 way) Long (to 1500 ft)	115k	1-2 See Notes 3-4 See Notes 5-6 IN 7-8 IN 9-10 OUT	1-2 IN 3-4 OUT 5-6 OUT 7-8 IN 9-10 OUT
5* Default	Full Duplex (2 way) Long (to 1500 ft)	19.2k	1-2 OUT 3-4 OUT 5-6 OUT 7-8 IN 9-10 OUT	1-2 OUT 3-4 IN 5-6 IN 7-8 OUT 9-10 IN

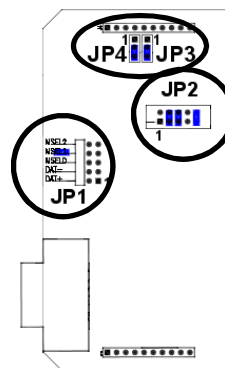

\*JP3 and JP4 are OUT for all modes except MODE 5. In Mode 5, JP3 and JP4 should be jumpered across pins 2-3.

### Notes:

- **Mode 1 is required when using multi output transmitters and when daisy chaining receivers.**
- **Mode 3 may introduce noise in video over 1,000 ft when serial communication occurs.**
- **JP1 1-2 and 3-4 terminate the serial bus and must be IN on the last receiver in a daisy chain or if using a point to point link UNLESS using Mode 5**

## Appendix D. Setting Sync Mode

The AK1200 has the capability for fixed and agile sync. The default sync mode setting is for agile sync which replicates the source sync polarity signals. However some displays require a fixed sync polarity that is not possible to change at the video source. 1080P signals may also require this mode if the sync is a very narrow pulse. The following details jumper settings to change the sync polarity of the horizontal and vertical sync signals (**Note that jumpers JP6 and JP7 have no affect in agile mode**):

Jumper Setting	JP5	JP6	JP7
Fixed Sync	IN	-	-
Agile Sync (default)	OUT	-	-
Horizontal Sync Positive	-	IN	-
Horizontal Sync Negative	-	OUT	-
Vertical Sync Positive	-	-	IN
Vertical Sync Negative	-	-	OUT

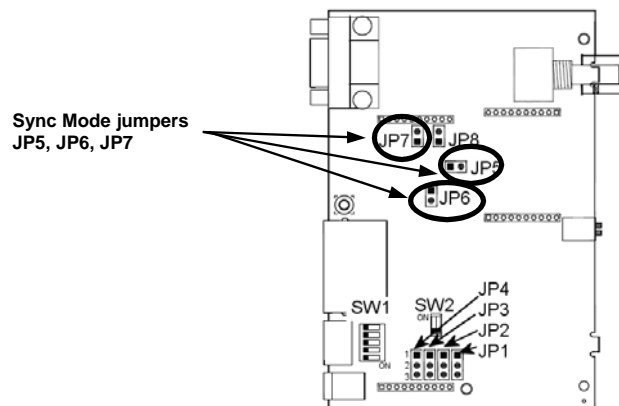

## Appendix E. Skew Module

The AK1200 receivers have an optional skew compensation module that can be installed or removed.

To install the skew compensation module:

- 1 Remove top cover.
- 2 Remove the 3 jumpers from J16 pins 1-2, 4-5, 7-8.
- 4 Insert the Skew assembly onto the PCB using 11 pin headers J16 and J17.
- 5 The correct orientation of the skew board is to place the side with the Magenta logo into header J17.
- 6 Reassemble unit.

Removal is the opposite of the above. Ensure 3 jumpers are installed in locations shown in Figure E-1.

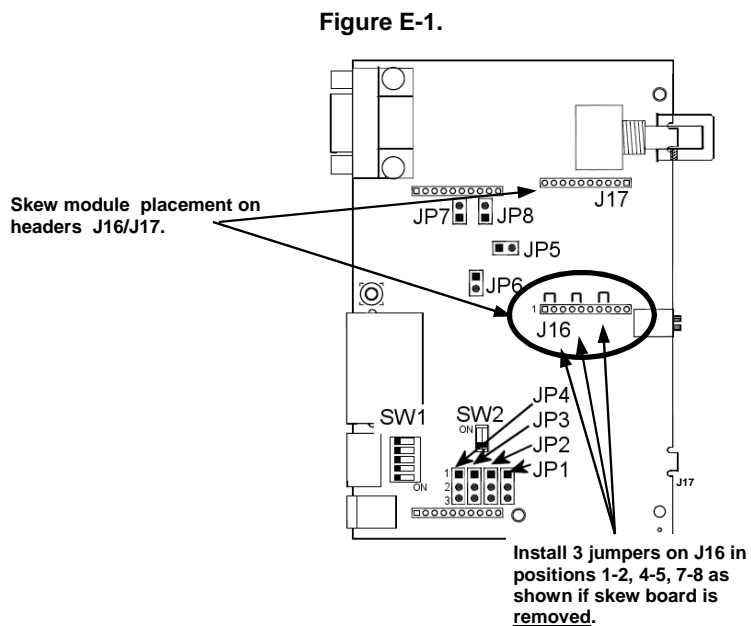

## Appendix F. Rackmounting Units

The Rackmount Kits include brackets for mounting a single transmitter, single receiver, or a single dual daisychainable receiver. Figure F-1 shows the 1-Unit Rackmount Bracket, which can be used to mount a single unit on a wall. Figure F-2 shows the 4-Unit Rackmount Bracket, which holds four units in a 19" x 1U rack.

Not shown are brackets for 6 units and brackets for AK and XR series receivers, T4 transmitters. The 3-Unit AK/XR receiver and T4 Transmitter Bracket holds 3 units in a 19" wide x 1U high panel. The 6-Unit AK/XR receiver and T4 Transmitter Bracket occupies 2U high rack space stacking 3 units atop 3 units.

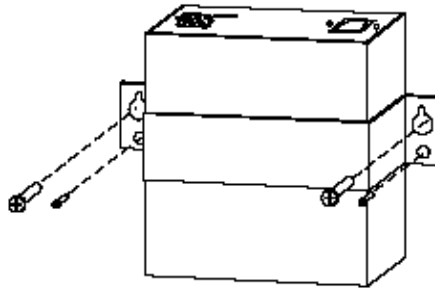

Figure F-1. Receiver Mounting Bracket.

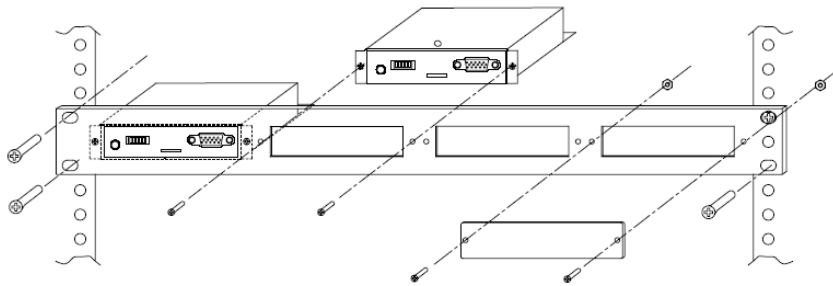

Figure F-2. Rack Mounting kit.

## Appendix G. Pollable Serial Mode

The SAP pollable serial daisychainable receivers with video, audio and RS232 serial feature the ability to open a bi-directional session between a pollable transmitter and a single pollable receiver in a daisychain installation.

Each pollable receiver must have a unique address set first. Once this has been done, a special command (discussed below) is sent to the transmitter to specify the receiver to open a session with. Once this has been done, serial communication can occur between the RS232 source and display. The transmitter is always addressed 0.

If an address of 0 is sent, the RS232 commands will be broadcast to all receivers.

The following details the installation and setup procedure.

To set the receiver address requires that each internal serial audio daughterboard in the receiver have a unique address set. This is done via an 8 position dipswitch. Use the following chart to determine the proper switch addresses. All receivers must have a unique address. *It is recommended to write the address on each receiver once this step has been completed.* It is also recommended to keep a list of receiver addresses and locations to make it easier to determine which receiver/display is desired to communicate with.

- 1) Remove the top cover assembly of the receiver
- 2) Locate the 8 position dipswitch on the internal daughterboard assembly and using the following chart, set the receiver address.

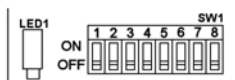

- 3) Replace cover assembly and install unit.
- 4) See below on using pollable serial mode.

In order to utilize the pollable serial mode in normal operation and connect to individual receivers, a special command needs to be sent to the transmitter in order to establish a session between transmitter and receiver.

Follow the steps below to do this (must be done from serial control application in use).

- 1) To establish a bi-directional RS232 session with a specific receiver, the transmitter needs the receivers address set. To do this send a CTRL-D <ID> carriage return, where <ID> is the receiver address (between 1-254)
- 2) To broadcast serial commands to all receivers, set <ID> to 0.
- 3) To disable serial communication to all receivers, set <ID> to 255 (to enable serial communication again, simply set <ID> to a receiver address).

Once a transmitter has the correct ID set, normal bi-directional communication can occur between transmitter and intended receiver.

## Appendix G. Pollable Serial Mode Address Chart

Addr	Switch Setting	ON	OFF	Addr	Switch Setting	ON	OFF	Addr	Switch Setting	ON	OFF	Addr	Switch Setting	ON	OFF
00	8 7 6 5 4 3 2 1			32	8 7 6 5 4 3 2 1			64	8 7 6 5 4 3 2 1			96	8 7 6 5 4 3 2 1		
01	8 7 6 5 4 3 2 1			33	8 7 6 5 4 3 2 1			65	8 7 6 5 4 3 2 1			97	8 7 6 5 4 3 2 1		
02	8 7 6 5 4 3 2 1			34	8 7 6 5 4 3 2 1			66	8 7 6 5 4 3 2 1			98	8 7 6 5 4 3 2 1		
03	8 7 6 5 4 3 2 1			35	8 7 6 5 4 3 2 1			67	8 7 6 5 4 3 2 1			99	8 7 6 5 4 3 2 1		
04	8 7 6 5 4 3 2 1			36	8 7 6 5 4 3 2 1			68	8 7 6 5 4 3 2 1			100	8 7 6 5 4 3 2 1		
05	8 7 6 5 4 3 2 1			37	8 7 6 5 4 3 2 1			69	8 7 6 5 4 3 2 1			101	8 7 6 5 4 3 2 1		
06	8 7 6 5 4 3 2 1			38	8 7 6 5 4 3 2 1			70	8 7 6 5 4 3 2 1			102	8 7 6 5 4 3 2 1		
07	8 7 6 5 4 3 2 1			39	8 7 6 5 4 3 2 1			71	8 7 6 5 4 3 2 1			103	8 7 6 5 4 3 2 1		
08	8 7 6 5 4 3 2 1			40	8 7 6 5 4 3 2 1			72	8 7 6 5 4 3 2 1			104	8 7 6 5 4 3 2 1		
09	8 7 6 5 4 3 2 1			41	8 7 6 5 4 3 2 1			73	8 7 6 5 4 3 2 1			105	8 7 6 5 4 3 2 1		
10	8 7 6 5 4 3 2 1			42	8 7 6 5 4 3 2 1			74	8 7 6 5 4 3 2 1			106	8 7 6 5 4 3 2 1		
11	8 7 6 5 4 3 2 1			43	8 7 6 5 4 3 2 1			75	8 7 6 5 4 3 2 1			107	8 7 6 5 4 3 2 1		
12	8 7 6 5 4 3 2 1			44	8 7 6 5 4 3 2 1			76	8 7 6 5 4 3 2 1			108	8 7 6 5 4 3 2 1		
13	8 7 6 5 4 3 2 1			45	8 7 6 5 4 3 2 1			77	8 7 6 5 4 3 2 1			109	8 7 6 5 4 3 2 1		
14	8 7 6 5 4 3 2 1			46	8 7 6 5 4 3 2 1			78	8 7 6 5 4 3 2 1			110	8 7 6 5 4 3 2 1		
15	8 7 6 5 4 3 2 1			47	8 7 6 5 4 3 2 1			79	8 7 6 5 4 3 2 1			111	8 7 6 5 4 3 2 1		
16	8 7 6 5 4 3 2 1			48	8 7 6 5 4 3 2 1			80	8 7 6 5 4 3 2 1			112	8 7 6 5 4 3 2 1		
17	8 7 6 5 4 3 2 1			49	8 7 6 5 4 3 2 1			81	8 7 6 5 4 3 2 1			113	8 7 6 5 4 3 2 1		
18	8 7 6 5 4 3 2 1			50	8 7 6 5 4 3 2 1			82	8 7 6 5 4 3 2 1			114	8 7 6 5 4 3 2 1		
19	8 7 6 5 4 3 2 1			51	8 7 6 5 4 3 2 1			83	8 7 6 5 4 3 2 1			115	8 7 6 5 4 3 2 1		
20	8 7 6 5 4 3 2 1			52	8 7 6 5 4 3 2 1			84	8 7 6 5 4 3 2 1			116	8 7 6 5 4 3 2 1		
21	8 7 6 5 4 3 2 1			53	8 7 6 5 4 3 2 1			85	8 7 6 5 4 3 2 1			117	8 7 6 5 4 3 2 1		
22	8 7 6 5 4 3 2 1			54	8 7 6 5 4 3 2 1			86	8 7 6 5 4 3 2 1			118	8 7 6 5 4 3 2 1		
23	8 7 6 5 4 3 2 1			55	8 7 6 5 4 3 2 1			87	8 7 6 5 4 3 2 1			119	8 7 6 5 4 3 2 1		
24	8 7 6 5 4 3 2 1			56	8 7 6 5 4 3 2 1			88	8 7 6 5 4 3 2 1			120	8 7 6 5 4 3 2 1		
25	8 7 6 5 4 3 2 1			57	8 7 6 5 4 3 2 1			89	8 7 6 5 4 3 2 1			121	8 7 6 5 4 3 2 1		
26	8 7 6 5 4 3 2 1			58	8 7 6 5 4 3 2 1			90	8 7 6 5 4 3 2 1			122	8 7 6 5 4 3 2 1		
27	8 7 6 5 4 3 2 1			59	8 7 6 5 4 3 2 1			91	8 7 6 5 4 3 2 1			123	8 7 6 5 4 3 2 1		
28	8 7 6 5 4 3 2 1			60	8 7 6 5 4 3 2 1			92	8 7 6 5 4 3 2 1			124	8 7 6 5 4 3 2 1		
29	8 7 6 5 4 3 2 1			61	8 7 6 5 4 3 2 1			93	8 7 6 5 4 3 2 1			125	8 7 6 5 4 3 2 1		
30	8 7 6 5 4 3 2 1			62	8 7 6 5 4 3 2 1			94	8 7 6 5 4 3 2 1			126	8 7 6 5 4 3 2 1		
31	8 7 6 5 4 3 2 1			63	8 7 6 5 4 3 2 1			95	8 7 6 5 4 3 2 1			127	8 7 6 5 4 3 2 1		



## Appendix G. Pollable Serial Mode Address Chart (cont.)

Addr	Switch Setting	ON	OFF	Addr	Switch Setting	ON	OFF	Addr	Switch Setting	ON	OFF	Addr	Switch Setting	ON	OFF
128		ON	OFF	160		ON	OFF	192		ON	OFF	224		ON	OFF
129		ON	OFF	161		ON	OFF	193		ON	OFF	225		ON	OFF
130		ON	OFF	162		ON	OFF	194		ON	OFF	226		ON	OFF
131		ON	OFF	163		ON	OFF	195		ON	OFF	227		ON	OFF
132		ON	OFF	164		ON	OFF	196		ON	OFF	228		ON	OFF
133		ON	OFF	165		ON	OFF	197		ON	OFF	229		ON	OFF
134		ON	OFF	166		ON	OFF	198		ON	OFF	230		ON	OFF
135		ON	OFF	167		ON	OFF	199		ON	OFF	231		ON	OFF
136		ON	OFF	168		ON	OFF	200		ON	OFF	232		ON	OFF
137		ON	OFF	169		ON	OFF	201		ON	OFF	233		ON	OFF
138		ON	OFF	170		ON	OFF	202		ON	OFF	234		ON	OFF
139		ON	OFF	171		ON	OFF	203		ON	OFF	235		ON	OFF
140		ON	OFF	172		ON	OFF	204		ON	OFF	236		ON	OFF
141		ON	OFF	173		ON	OFF	205		ON	OFF	237		ON	OFF
142		ON	OFF	174		ON	OFF	206		ON	OFF	238		ON	OFF
143		ON	OFF	175		ON	OFF	207		ON	OFF	239		ON	OFF
144		ON	OFF	176		ON	OFF	208		ON	OFF	240		ON	OFF
145		ON	OFF	177		ON	OFF	209		ON	OFF	241		ON	OFF
146		ON	OFF	178		ON	OFF	210		ON	OFF	242		ON	OFF
147		ON	OFF	179		ON	OFF	211		ON	OFF	243		ON	OFF
148		ON	OFF	180		ON	OFF	212		ON	OFF	244		ON	OFF
149		ON	OFF	181		ON	OFF	213		ON	OFF	245		ON	OFF
150		ON	OFF	182		ON	OFF	214		ON	OFF	246		ON	OFF
151		ON	OFF	183		ON	OFF	215		ON	OFF	247		ON	OFF
152		ON	OFF	184		ON	OFF	216		ON	OFF	248		ON	OFF
153		ON	OFF	185		ON	OFF	217		ON	OFF	249		ON	OFF
154		ON	OFF	186		ON	OFF	218		ON	OFF	250		ON	OFF
155		ON	OFF	187		ON	OFF	219		ON	OFF	251		ON	OFF
156		ON	OFF	188		ON	OFF	220		ON	OFF	252		ON	OFF
157		ON	OFF	189		ON	OFF	221		ON	OFF	253		ON	OFF
158		ON	OFF	190		ON	OFF	222		ON	OFF	254		ON	OFF
159		ON	OFF	191		ON	OFF	223		ON	OFF				

NOTES:



NOTES:



**Magenta Research**

128 Litchfield Road, New Milford, CT 06776 USA  
(860) 210-0546 FAX (860) 210-1758  
[www.magenta-research.com](http://www.magenta-research.com)

PN 5310201-01, Rev 03, Mar-2009