



---

## CS1732B / CS1734B

2/4-Port USB 2.0  
KVMP™ Switch with OSD  
User Manual



[www.aten.com](http://www.aten.com)

## FCC Information

Federal Communication Commission Interference Statement: This equipment has been tested and found to comply with the limits for a Class B digital service, pursuant to Part 15 of the FCC rules. These limits are designed to provide reasonable protection against harmful interference in a residential installation. Any changes or modifications made to this equipment may void the user's authority to operate this equipment. This equipment generates, uses, and can radiate radio frequency energy. If not installed and used in accordance with the instructions, may cause harmful interference to radio communications. However, there is no guarantee that interference will not occur in a particular installation. If this equipment does cause harmful interference to radio or television reception, which can be determined by turning the equipment off and on, the user is encouraged to try to correct the interference by one or more of the following measures:

- ◆ Reorient or relocate the receiving antenna.
- ◆ Increase the separation between the equipment and receiver.
- ◆ Connect the equipment into an outlet on a circuit different from that to which the receiver is connected.
- ◆ Consult the dealer or an experienced radio/TV technician for help.

FCC Caution: Any changes or modifications not expressly approved by the party responsible for compliance could void the user's authority to operate this equipment.

## RoHS

This product is RoHS compliant.

## SJ/T 11364-2006

The following contains information that relates to China.

部件名称	有毒有害物质或元素					
	铅	汞	镉	六价铬	多溴联苯	多溴二苯醚
电器部件	●	○	○	○	○	○
机构部件	○	○	○	○	○	○

○: 表示该有毒有害物质在该部件所有均质材料中的含量均在SJ/T 11363-2006规定的限量要求之下。

●: 表示符合欧盟的豁免条款, 但该有毒有害物质至少在该部件的某一均质材料中的含量超出SJ/T 11363-2006的限量要求。

×: 表示该有毒有害物质至少在该部件的某一均质材料中的含量超出SJ/T 11363-2006的限量要求。



---

## User Information

---

### Online Registration

Be sure to register your product at our online support center:

International	<a href="http://eservice.aten.com">http://eservice.aten.com</a>
---------------	---

### Telephone Support

For telephone support, call this number:

International	886-2-8692-6959
China	86-10-5255-0110
Japan	81-3-5615-5811
Korea	82-2-467-6789
North America	1-888-999-ATEN ext 4988
United Kingdom	44-8-4481-58923

### User Notice

All information, documentation, and specifications contained in this manual are subject to change without prior notification by the manufacturer. The manufacturer makes no representations or warranties, either expressed or implied, with respect to the contents hereof and specifically disclaims any warranties as to merchantability or fitness for any particular purpose. Any of the manufacturer's software described in this manual is sold or licensed *as is*. Should the programs prove defective following their purchase, the buyer (and not the manufacturer, its distributor, or its dealer), assumes the entire cost of all necessary servicing, repair and any incidental or consequential damages resulting from any defect in the software.

The manufacturer of this system is not responsible for any radio and/or TV interference caused by unauthorized modifications to this device. It is the responsibility of the user to correct such interference.

The manufacturer is not responsible for any damage incurred in the operation of this system if the correct operational voltage setting was not selected prior to operation. PLEASE VERIFY THAT THE VOLTAGE SETTING IS CORRECT BEFORE USE.

## Package Contents

---

The CS1732B / CS1734B USB 2.0 KVMP Switch with OSD package consists of:

- ◆ 1 CS1732B / CS1734B KVMP Switch
- ◆ 2 Custom USB KVM Cable Sets (CS1732B)
- ◆ 4 Custom USB KVM Cable Sets (CS1734B)
- ◆ 1 Firmware Upgrade Cable
- ◆ 1 Power Adapter
- ◆ 1 User Instructions\*

Check to make sure that all the components are present and that nothing got damaged in shipping. If you encounter a problem, contact your dealer.

Read this manual thoroughly and follow the installation and operation procedures carefully to prevent any damage to the unit, and/or any of the devices connected to it.

---

\* Features may have been added to the CS1732B / CS1734B since this manual was published. Please visit our website to download the most up-to-date version of the manual.

---

# Contents

---

FCC Information . . . . .	ii
RoHS . . . . .	ii
SJ/T 11364-2006 . . . . .	ii
User Information . . . . .	iii
Online Registration . . . . .	iii
Telephone Support . . . . .	iii
User Notice . . . . .	iii
Package Contents . . . . .	iv
About this Manual . . . . .	vii
Conventions . . . . .	viii
Product Information . . . . .	viii
<b>1. Introduction</b>	
Overview . . . . .	1
Features . . . . .	3
Requirements . . . . .	4
Console . . . . .	4
Computer . . . . .	4
Cables . . . . .	4
Operating System Support . . . . .	5
CS1732B / CS1734B Front View . . . . .	6
CS1732B / CS1734B Rear View . . . . .	8
<b>2. Hardware Setup</b>	
Cable Connection . . . . .	11
<b>3. Basic Operation</b>	
Port Switching . . . . .	15
Manual Port Selection . . . . .	15
Mouse Port Selection . . . . .	16
Hot Plugging . . . . .	16
Powering Off and Restarting . . . . .	16
Port ID Numbering . . . . .	17
Alternative Manual Port Selection Settings . . . . .	17
<b>4. Keyboard Port Operation</b>	
Hotkey Port Control . . . . .	19
Invoking Hotkey Setting Mode (HSM) . . . . .	19
Alternate HSM Invocation Keys . . . . .	20
Selecting the Active Port . . . . .	20
Going Directly to a Port . . . . .	21
Auto Scanning . . . . .	22
Setting the Scan Interval: . . . . .	22
Invoking Auto Scan: . . . . .	22
Skip Mode . . . . .	23

Video DynaSync .....	24
List Hotkey Settings .....	24
USB Reset .....	24
Invoking the OSD / Alternate OSD Invocation Keys .....	25
Hotkey Summary Table .....	26

## **5. OSD Operation**

OSD Overview .....	27
OSD Main Screen .....	27
OSD Navigation .....	28
OSD Main Screen Headings .....	29
OSD Functions .....	30
F3: SCAN .....	30
F4: SET .....	31

## **6. Keyboard Emulation**

Mac Keyboard .....	35
Sun Keyboard .....	36

## **7. The Firmware Upgrade Utility**

Before you Begin .....	37
Starting the Upgrade .....	38
Upgrade Succeeded .....	39
Upgrade Failed .....	40
Shorting the Mainboard Jumper .....	40
CS1732B .....	40
CS1734B .....	40

## **Appendix**

Safety Instructions .....	41
Technical Support .....	43
International .....	43
North America .....	43
Factory Default Settings .....	44
Pushbuttons and Hotkeys .....	44
OSD .....	44
Specifications .....	45
Troubleshooting .....	46
About SPHD Connectors .....	47
Limited Warranty .....	47

## About this Manual

---

This User Manual is provided to help you get the most from your system. It covers all aspects of installation, configuration and operation. An overview of the information found in the manual is provided below.

**Chapter 1, Introduction,** introduces you to the CS1732B / CS1734B system. Its purpose, features and benefits are presented, and its front and back panel components are described.

**Chapter 2, Hardware Setup,** describes how to set up your installation. Diagrams showing the necessary steps are provided.

**Chapter 3, Basic Operation,** explains the fundamental concepts involved in operating the CS1732B / CS1734B.

**Chapter 4, Keyboard Port Operation,** details all of the concepts and procedures involved in the keyboard port Hotkey operation of your CS1732B / CS1734B installation.

**Chapter 5, OSD Operation,** provides a complete description of the CS1732B / CS1734B's OSD (On Screen Display), and how to work with it.

**Chapter 6, Keyboard Emulation,** provides tables that list the PC to Mac and PC to Sun keyboard emulation mappings.

**Chapter 7, The Firmware Upgrade Utility,** explains how to use this utility to upgrade the CS1732B / CS1734B's firmware with the latest available versions.

**An Appendix,** provides specifications and other technical information regarding the CS1732B / CS1734B.

## Conventions

---

This manual uses the following conventions:

- Monospaced     Indicates text that you should key in.
- [ ]             Indicates keys you should press. For example, [Enter] means to press the **Enter** key. If keys need to be chorded, they appear together in the same bracket with a plus sign between them: [Ctrl+Alt].
- 1.             Numbered lists represent procedures with sequential steps.
- ◆             Bullet lists provide information, but do not involve sequential steps.
- Indicates selecting the option (on a menu or dialog box, for example), that comes next. For example, Start → Run means to open the *Start* menu, and then select *Run*.
-              Indicates critical information.

## Product Information

---

For information about all ATEN products and how they can help you connect without limits, visit ATEN on the Web or contact an ATEN Authorized Reseller. Visit ATEN on the Web for a list of locations and telephone numbers:

International	<a href="http://www.aten.com">http://www.aten.com</a>
North America	<a href="http://www.aten-usa.com">http://www.aten-usa.com</a>



# Chapter 1

## Introduction

### Overview

---

The CS1732B / CS1734B are two- and four-port KVM Switches combined with a two-port USB 2.0 hub. As KVM switches, they allow users to access two and four computers from a single keyboard, monitor, and mouse console.

The CS1732B / CS1734B improves on previous designs by giving the user a choice of either transferring keyboard and mouse data to the computers via a USB connection, or with the traditional PS/2 connection. If a USB connection is used, the CS1732B / CS1734B's integrated two-port USB hub is available for each computer to access any peripherals connected to the hub on a one-at-a-time basis.

The CS1732B / CS1734B's asynchronous switching feature allows independent switching of the KVM, USB hub, and audio focus. If you wish, you can give one computer the KVM console focus, another the USB hub focus, while a third has the audio focus. You can work on a spreadsheet on one computer, for example, while you print from a second computer at the same time, thus eliminating the need to purchase separate USB hubs or peripheral sharers.

Recognizing the importance of sound, the CS1732B / CS1734B is 2.1 channel surround sound audio enabled. A single microphone can provide audio input to each of the computers, and you can listen to the audio output of each computer on a single set of speakers (on a one-at-a-time basis).

Setup is fast and easy; simply plug cables into their appropriate ports. There is no software to configure, no installation routines, and no incompatibility problems. Since the CS1732B / CS1734B intercepts keyboard input directly, it works on multiple operating platforms (PC compatible, Mac\*, Sun\*, etc.).

There are four convenient methods to access the computers: pushbutton port selection switches located on the unit's front panel; an OSD (On Screen Display) selection panel; *Hotkey* combinations entered from the keyboard; and an innovative new mouse port-switching feature that allows you cycle through the ports using the mouse alone.

Since a single console manages all of the computers, the CS1732B / CS1734B installation: 1) eliminates the expense of having to purchase separate console components for each computer; 2) saves all the space those extra components would take up; 3) saves on energy costs; and 4) eliminates the inconvenience and wasted effort involved in constantly moving from one computer to another.

---

\* For PC compatible computers. Mac and Sun computers must use the USB cable connection (see *Cables*, page 4).

---

## Features

---

- ◆ 2/4-port KVM switch with USB 2.0 support and 2.1 channel surround sound audio
- ◆ One console controls 2 (CS1732B ) or 4 (CS1734B ) computers and two additional USB devices
- ◆ 2-port USB 2.0 hub built in
- ◆ Dual interface – supports computers with PS/2 or USB keyboard and mouse configurations
- ◆ Audio-enabled – full bass response provides a rich experience for 2.1 channel surround sounds systems
- ◆ Console audio ports on front panel for easy access – ideal for IP phone use
- ◆ Independent switching of KVM, USB, and Audio focus
- ◆ Superior video quality; 2048 x 1536; DDC2B
- ◆ Supports widescreen resolutions
- ◆ Computer selection via front panel pushbuttons, OSD (On Screen Display), hotkeys, and mouse
- ◆ Multiplatform support – Windows 2000/XP/Vista, Linux, Mac, and Sun
- ◆ Console mouse port emulation / bypass feature supports full mouse driver and multifunction mice
- ◆ Video DynaSync – stores the console monitor’s EDID (Extended Display Identification Data) to optimize display resolution
- ◆ Complete keyboard emulation for error free booting
- ◆ Sun/Mac keyboard support and emulation\*
- ◆ Auto Scan Mode for monitoring all computers
- ◆ LED display for easy status monitoring
- ◆ Easy installation – no software required

---

\*  
1. PC keyboard combinations emulate Sun/Mac keyboards  
2. Sun/Mac keyboards only work with their own computers

---

## Requirements

---

### Console

- ◆ A VGA, SVGA, or Multisync monitor capable of the highest resolution that you will be using on any computer in the installation.
- ◆ A USB mouse
- ◆ A USB keyboard

### Computer

The following equipment must be installed on each computer:

- ◆ A VGA, SVGA or Multisync card.
- ◆ USB Type A port, or PS/2 keyboard and mouse ports.

### Cables

Only cable sets specifically designed to work with this switch may be used to link to the computers. Two 1.2 m cables sets are provided with the CS1732B package. Four (two 1.2 m and two 1.8 m) cable sets are provided with the CS1734B package. They use the USB to transfer the keyboard and mouse input from your console to the computer.

Both switches also support computers that use PS/2 connectors to transfer keyboard and mouse data. Cable sets with PS/2 connectors, as well as longer cable sets are available from your dealer. See the following table for details:

Connector	Cable Length	Part Number
USB	1.2 m	2L-5301U
USB	1.8 m	2L-5302U
USB	3 m	2L-5303U
USB	5 m	2L-5305U
PS/2	1.2 m	2L-5301P
PS/2	1.8 m	2L-5302P

---

**Note:** The CS1732B / CS1734B's USB hub function only works with USB cable set connections. It will not work with PS/2 cable set connections.

---

---

## Operating System Support

Supported operating systems are shown in the table, below:

OS		Version
Windows		2000 and higher
Linux*	RedHat	7.1 and higher; Fedora Core 2 and higher
	SuSE	9.0 and higher
	Mandriva (Mandrake)	9.0 and higher
UNIX	AIX	4.3 and higher
	FreeBSD	4.2 and higher
	Sun	Solaris 9 and higher
Novell	Netware	5.0 and higher
Mac		OS 9.0 and higher
DOS		6.22 and higher

---

**Note:** Supports Linux Kernel 2.6 and higher.

---

# CS1732B / CS1734B Front View

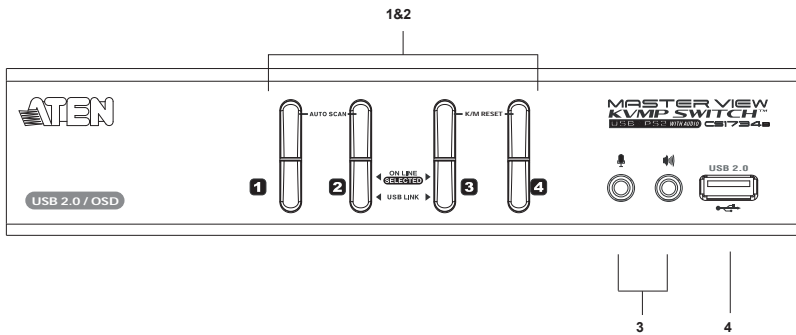
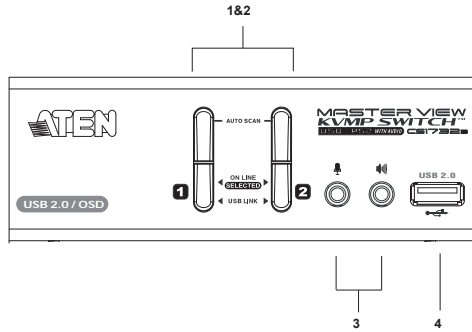

No.	Component	Description				
1	Port Selection Pushbuttons	<p>Pressing a front panel pushbutton brings the focus to the computer attached to its corresponding port.</p> <p>There are two settings for Front Panel Pushbutton Switching Operation: MODE 1 (Default Setting) and MODE 2 (Alternative Setting). The <b>F4:SET</b> function in the OSD allows you choose between these two settings. See <i>F4: SET</i>, page 31.</p> <p>For full details of the MODE 1 (Default) and MODE 2 (Alternative) Front Panel Pushbutton Switching Operation settings, see <i>BUTTON SETTINGS</i>, page 32.</p>				
2	Port LEDs	<p>The Port LEDs are built into the Port Selection Switches. The upper ones are the KVM Port LEDs; the lower ones are the USB LEDs:</p> <table border="1" data-bbox="372 555 976 1023"> <tbody> <tr> <td data-bbox="372 555 478 820">KVM:</td> <td data-bbox="478 555 976 820"> <ul style="list-style-type: none"> <li>◆ Lights DIM ORANGE to indicate that the computer attached to its corresponding port is up and running (On Line).</li> <li>◆ Changes to BRIGHT ORANGE to indicate that the computer attached to its corresponding port is the one that has the KVM focus (Selected).</li> <li>◆ Flashes to indicate that the computer attached to its corresponding port is being accessed under Auto Scan mode.</li> </ul> </td> </tr> <tr> <td data-bbox="372 820 478 1023">USB:</td> <td data-bbox="478 820 976 1023"> <ul style="list-style-type: none"> <li>◆ Lights DIM GREEN to indicate that there is a USB cable connection to the computer attached to its corresponding port. Does not light if there is no USB connection to the computer.</li> <li>◆ Changes to BRIGHT GREEN to indicate that the computer attached to its corresponding port is the one that has access to the USB peripherals.</li> </ul> </td> </tr> </tbody> </table>	KVM:	<ul style="list-style-type: none"> <li>◆ Lights DIM ORANGE to indicate that the computer attached to its corresponding port is up and running (On Line).</li> <li>◆ Changes to BRIGHT ORANGE to indicate that the computer attached to its corresponding port is the one that has the KVM focus (Selected).</li> <li>◆ Flashes to indicate that the computer attached to its corresponding port is being accessed under Auto Scan mode.</li> </ul>	USB:	<ul style="list-style-type: none"> <li>◆ Lights DIM GREEN to indicate that there is a USB cable connection to the computer attached to its corresponding port. Does not light if there is no USB connection to the computer.</li> <li>◆ Changes to BRIGHT GREEN to indicate that the computer attached to its corresponding port is the one that has access to the USB peripherals.</li> </ul>
KVM:	<ul style="list-style-type: none"> <li>◆ Lights DIM ORANGE to indicate that the computer attached to its corresponding port is up and running (On Line).</li> <li>◆ Changes to BRIGHT ORANGE to indicate that the computer attached to its corresponding port is the one that has the KVM focus (Selected).</li> <li>◆ Flashes to indicate that the computer attached to its corresponding port is being accessed under Auto Scan mode.</li> </ul>					
USB:	<ul style="list-style-type: none"> <li>◆ Lights DIM GREEN to indicate that there is a USB cable connection to the computer attached to its corresponding port. Does not light if there is no USB connection to the computer.</li> <li>◆ Changes to BRIGHT GREEN to indicate that the computer attached to its corresponding port is the one that has access to the USB peripherals.</li> </ul>					
3	Console Connectors (Audio)	<p>Your main console microphone and speakers plus in here. These audio ports have priority over the ports in the rear panel.</p>				
4	USB 2.0 Peripheral Port	<p>USB peripherals (printers, scanners, etc.) can plug into either port.</p>				

# CS1732B / CS1734B Rear View

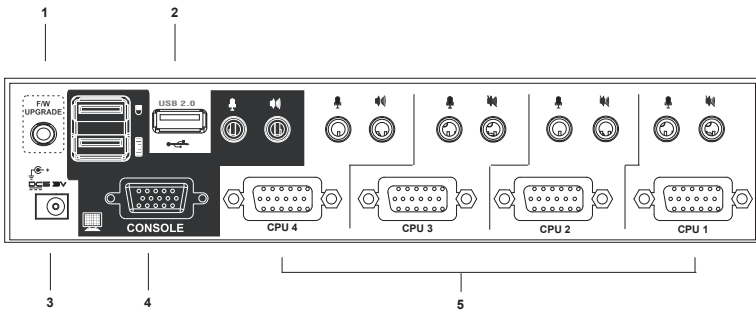
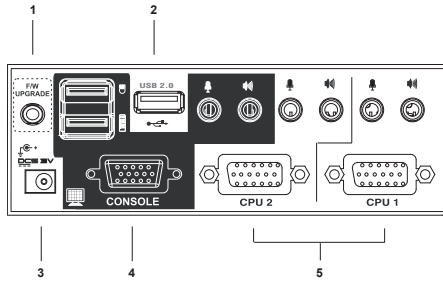



---

No.	Component	Description
1	Firmware Upgrade Port	The Firmware Upgrade Cable that transfers the firmware upgrade data to the CS1732B / CS1734B plugs in here. See <i>The Firmware Upgrade Utility</i> , page 37 for details.
2	USB 2.0 Peripheral Port	USB 2.0 peripherals (printers, scanners, etc.) can plug into this port.
3	Power Jack	The power adapter cable plugs into this jack.
4	Console Port Section	The cables from your USB keyboard and mouse, monitor, microphone and speakers plug in here. Each connector is marked with an appropriate icon to indicate itself.
5	KVM Port Section	The cables that link the switch to your computers plug in here. Each KVM port is comprised of a microphone jack, speaker jack, and KVM data connector.

---

**Note:** The shape of these connectors has been specifically modified so that only KVM cables designed to work with this switch can plug in (see *Cables*, page 4 for details). Do **NOT** attempt to use ordinary 15-pin VGA connector cables to link these ports to the computers.

---

This Page Intentionally Left Blank

# Chapter 2

## Hardware Setup



1. Important safety information regarding the placement of this device is provided on page 41. Please review it before proceeding.
2. Make sure that the power to all devices connected to the installation are turned off. You must unplug the power cords of any computers that have the Keyboard Power On function

### Cable Connection

---

To set up your CS1732B / CS1734B installation, refer to the installation diagram on the following pages, and do the following:

1. Plug your USB keyboard and USB mouse into the USB Ports located on the unit's back panel.
2. Plug your monitor into the Console monitor port located on the unit's rear panel and power on the monitor.
3. Plug your main microphone and speakers into the Console microphone and 2.1 surround sound speaker jacks located on the unit's front panel. The microphone and speakers plugged into this panel have priority over those plugged into the back panel.
4. Using a KVM cable set (provided with this package), plug the custom SPHD connector into any available KVM Port on the switch and plug the accompanying microphone and speaker connectors into the KVM Port's microphone and speaker jacks.

---

**Note:** 1. The connectors and jacks are color coded and marked with an appropriate icon for easy installation.

2. Be sure that all the plugs are in the same KVM Port sockets (all in Port 1, all in Port 2, etc.).
-

5. At the other end of the cable:
  - a) For a PS/2 connection (see page 13), plug the keyboard, mouse, video, microphone and speaker cables into their respective ports on the computer.
  - b) For a USB connection (see page 13), plug the USB, video, microphone and speaker cables into their respective ports on the computer.
- Repeat steps 4 and 5 for any other computers you are connecting up.
6. Plug the power adapter that came with your switch into an AC power source, then plug the power adapter cable into the switch's Power Jack.
7. Plug your USB peripherals into the USB hub sections on the front and back panels.
8. Turn on the power to the computers

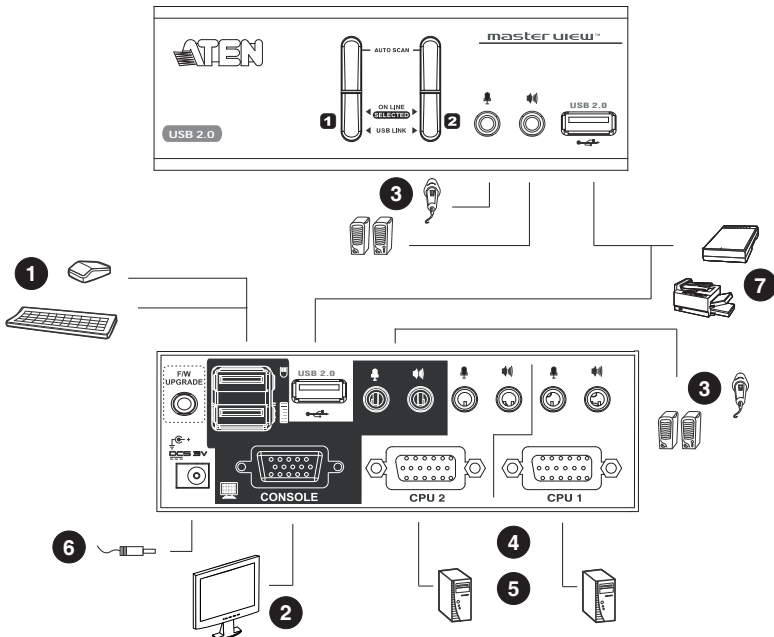

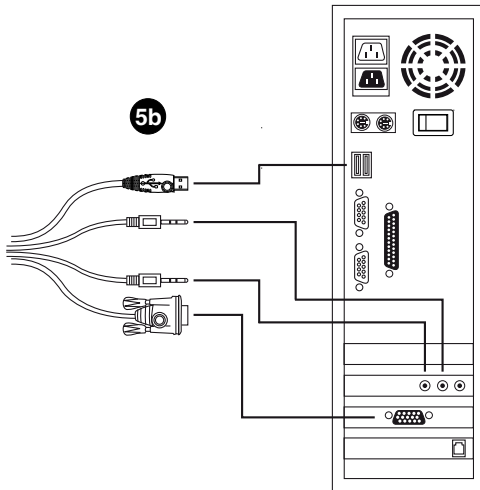
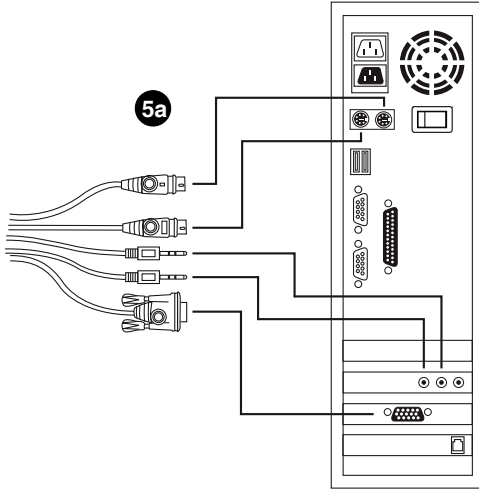

This Page Intentionally Left Blank

# Chapter 3

## Basic Operation

This chapter explains the fundamental concepts involved in operating the CS1732B / CS1734B.

### Port Switching

---

There are four convenient methods to access the computers: Manual – which involves pressing the port selection pushbuttons located on the unit's front panel; Mouse – which involves double-clicking the mouse scroll wheel; Keyboard Port Hotkey – which involves entering combinations from the keyboard (see Chapter 4, *Keyboard Port Operation*); and OSD – which involves using the CS1732B / CS1734B's On Screen Display (see Chapter 5, *OSD Operation*).

#### Manual Port Selection

For manual port selection:

- ◆ Press a port selection pushbutton *once* to bring the KVM, Audio and USB focus simultaneously to the computer attached to its corresponding port.
- ◆ Press a port selection pushbutton *twice* to bring the Audio focus to the computer attached to its corresponding port (in 2 secs).
- ◆ Press and hold a port selection pushbutton for longer than two seconds to bring only the KVM focus to the computer attached to its corresponding port.
- ◆ Press and hold port selection pushbuttons 1 and 2 simultaneously for 2 *seconds* to start Auto Scan Mode. See also *Auto Scanning*, page 22 and *F3: SCAN*, page 30)
- ◆ Press port selection pushbuttons 3 and 4 simultaneously for 2 seconds to perform a keyboard and mouse reset (CS1734B only).

## **Mouse Port Selection**

The mouse port-switching function, which allows you to select a port using the mouse, is a new feature of the latest CS1732B / CS1734B. Simply double-click the scroll wheel on the mouse to switch between ports. The mouse port-switching function allows you to cycle through the ports in sequential order – 1 to 2, 2 to 1 for the CS1732B; 1 to 2, 2 to 3, 3 to 4, 4 to 1 for the CS1734B.

---

**Note:** The default setting for the mouse port-switching function is OFF. To enable the mouse port-switching function, use the OSD. See Table , “MOUSE SWITCHING FUNCTION,” on page 33

---

## **Hot Plugging**

The CS1732B / CS1734B supports USB hot plugging – components can be removed and added back into the installation by unplugging their cables from the USB hub ports without the need to shut the unit down.

## **Powering Off and Restarting**

If it becomes necessary to Power Off the unit, before starting it back up you must do the following:

1. Shut down all the computers that are attached to the switch.
2. Unplug the switch’s power adapter cable.
3. Wait 10 seconds, then plug the switch’s power adapter cable back in.
4. After the switch is up, Power On the computers.



## Port ID Numbering

---

Each KVM port on the CS1732B / CS1734B switch is assigned a port number (1, 2, 3, or 4). The port numbers are marked on the rear panel of the switch (see *CS1732B / CS1734B Rear View*, page 8, for details).

The Port ID of a computer is derived from the KVM port number it is connected to. For example, a computer connected to KVM port 2 has a Port ID of 2.

The Port ID is used to specify which computer gets the KVM USB peripheral, and audio focus with the Hotkey port selection method (see *Selecting the Active Port*, page 20, for details).

## Alternative Manual Port Selection Settings

---

Changing the OSD settings will invoke the alternative front panel pushbutton manual port selection settings as follows (see Table , “BUTTON SETTINGS,” on page 32):

- ◆ Press and release a port selection pushbutton once to bring the KVM focus to the computer attached to its corresponding port. The USB and Audio focus do not change – they stay with the port that they are already on.
- ◆ Press a port selection pushbutton *twice* to bring the audio focus to the computer attached to its corresponding port.
- ◆ Press and hold a port selection pushbutton for *more than 2 seconds* to bring the KVM focus plus the USB and Audio focus to the computer attached to its corresponding port.
- ◆ Press and hold port selection pushbuttons 1 and 2 simultaneously for *2 seconds* to start Auto Scan Mode. See page 22, for details.

---

**Note:** Press and release either port selection pushbutton to stop Auto Scan Mode. The KVM focus goes to the computer attached to the corresponding port of the pushbutton you pressed.

---

This Page Intentionally Left Blank

# Chapter 4

## Keyboard Port Operation

This chapter details the concepts and procedures involved in the keyboard port Hotkey operation of your CS1732B / CS1734B installation; hotkey operation within the OSD is discussed in the previous chapter, *OSD Operation*.

### Hotkey Port Control

---

Hotkey Port Control allows you to provide KVM focus to a particular computer directly from the keyboard. The CS1732B / CS1734B provides the following Hotkey Port Control features:

- ◆ Selecting the Active Port
- ◆ Auto Scanning
- ◆ Skip Mode Switching

### Invoking Hotkey Setting Mode (HSM)

All Hotkey operations begin by invoking *Hotkey Setting Mode*. Invoking Hotkey Setting Mode (HSM) takes two steps:

1. Press and hold down the **Num Lock** key;
2. Press the **minus** key:

[Num Lock] + [-];

When HSM is active:

- ◆ The Caps Lock and Scroll Lock LEDs flash in succession to indicate so. They stop flashing and revert to normal status when you exit Hotkey Mode.
- ◆ Ordinary keyboard and mouse functions are suspended – only Hotkey compliant keystrokes (described in the sections that follow), can be input.

Pressing [Esc] or [SpaceBar] exits HSM.

## **Alternate HSM Invocation Keys**

An alternate set of HSM invocation keys is provided in case the default set conflicts with programs running on the computers.

To switch to the alternate HSM invocation set, do the following:

1. Invoke HSM (see page 19).
2. Press and release **[H]**.

The HSM invocation keys become the Ctrl key (instead of Num Lock) and the F12 key (instead of minus).

---

**Note:** This procedure is a toggle between the two methods. To revert back to the original HSM invocation keys, invoke HSM, then press and release the **H** key again.

---

## **Selecting the Active Port**

Each KVM port is assigned a Port ID (see , page 14). You can directly access any computer on the installation with a Hotkey combination that specifies the Port ID of the KVM Port that the computer is connected to. The steps involved are:

1. Invoke HSM (see page 19)
2. Key in the Port ID
3. Press **[Enter]**

After you press [Enter], the KVM focus switches to the designated computer and you automatically exit HSM.

## Going Directly to a Port

Hotkey	Action
[Num Lock] + [-] [Enter]	Brings the <b>KVM</b> , <b>USB hub</b> , and <b>audio</b> focus from the port that currently has the KVM focus to the next port on the installation (1 to 2; 2 to 1 for the CS1732B; 1 to 2; 2 to 3; 3 to 4; 4 to 1 for the CS1734B). <b>Note:</b> The KVM, USB hub, and audio focus all go to this port even if they were on different ports to begin with.
[Num Lock] + [-] [K] [Enter]	Brings only the <b>KVM</b> focus from the port that currently has it to the next port on the installation. The USB hub and audio focus remain where they are.
[Num Lock] + [-] [U] [Enter]	Brings only the <b>USB hub</b> focus from the port that currently has it to the next port on the installation. The KVM and audio focus remain where they are.
[Num Lock] + [-] [S] [Enter]	Brings only the <b>audio</b> focus from the port that currently has it to the next port on the installation. The KVM and USB hub focus remain where they are.
[Num Lock] + [-] [n] [Enter]	Brings the <b>KVM</b> , <b>USB hub</b> , and the <b>audio</b> focus to the computer attached to the port corresponding to the specified Port ID. <b>Note:</b> The KVM, USB hub, and audio focus all go to this port even if they were on different ports to begin with.
[Num Lock] + [-] [n] [K] [Enter]	Brings only the <b>KVM</b> focus to the computer attached to the specified port. The USB hub and audio focus remain where they are.
[Num Lock] + [-] [n] [U] [Enter]	Brings only the <b>USB hub</b> focus to the computer attached to the specified port. The KVM and audio focus remain where they are.
[Num Lock] + [-] [n] [S] [Enter]	Brings only the <b>audio</b> focus to the computer attached to the specified port. The KVM and USB hub focus remain where they are.
[Num Lock] + [-] [n] [K] [U] [Enter]	Brings the <b>KVM</b> and <b>USB hub</b> focus to the computer attached to the specified port. The audio focus remains where it is.
[Num Lock] + [-] [n] [K] [S] [Enter]	Brings the <b>KVM</b> and <b>audio</b> focus to the computer attached to the specified port. The USB hub focus remains where it is.
[Num Lock] + [-] [n] [U] [S] [Enter]	Brings the <b>USB hub</b> and <b>audio</b> focus to the computer attached to the specified port. The KVM focus remains where it is.
[Num Lock] + [-] [n] [K] [S] [U] [Enter]	Brings the <b>KVM</b> , <b>USB hub</b> , and the <b>audio</b> focus to the computer attached to the port corresponding to the specified Port ID. <b>Note:</b> This is the same action as [Num Lock] + [-] [n] [Enter]

**Note:** The **n** stands for the computer's Port ID number (1, 2, 3, 4). Replace the **n** with the appropriate Port ID when entering hotkey combinations.

## Auto Scanning

Auto Scan automatically switches among all the active KVM Ports that are accessible to the currently logged on User at regular intervals, so that he can monitor their activity automatically. See the following table below for details:

Hotkey	Action
[Num Lock] + [-] [A] [Enter]	Starts Auto Scan. The KVM focus cycles from port to port at 5 second intervals.
[Num Lock] + [-] [A] [n] [Enter]	Starts Auto Scan. The KVM focus cycles from port to port at <b>n</b> second intervals.

---

**Note:** The **n** stands for the number of seconds that the CS1732B / CS1734B should dwell on a port before moving on to the next. Replace the **n** with a number between 1 and 255 when entering this hotkey combination.

---

### Setting the Scan Interval:

The amount of time Auto Scan dwells on each port can also be set with the *Scan Duration* setting of the OSD **F6 SET** function (see *F4: SET*, page 31).

### Invoking Auto Scan:

To start Auto Scanning, key in the following Hotkey combination:

1. Invoke HSM (see page 19)
2. Press **[A]**. After you press **A**, you automatically exit HSM, and enter Auto Scan Mode.
  - ♦ While Auto Scan Mode is in effect, ordinary keyboard and mouse functions are suspended – only Auto Scan Mode compliant keystrokes can be input. You must exit Auto Scan Mode in order to regain normal control of the console.
3. To exit Auto Scan Mode press **[Esc]** or **[Spacebar]**. Auto Scanning stops when you exit Auto Scan Mode.

## **Skip Mode**

This feature allows you to switch between computers in order to monitor them manually. You can dwell on a particular port for as long or as little as you like – as opposed to Auto Scanning, which automatically switches after a fixed interval. To invoke Skip Mode, key in the following Hotkey combination:

1. Invoke HSM (see page 19).

2. Key in **[Arrow]**

- ◆ Where [Arrow] refers to one of the Arrow keys. After you press [Arrow], you automatically exit Hotkey Mode, and enter Skip Mode where you can switch ports as follows:

←	Skips from the current port to the first accessible port previous to it.
→	Skips from the current port to the next accessible port.
↑	Skips from the current port to the last accessible port of the previous Station.
↓	Skips from the current port to the first accessible port of the next Station.

- ◆ Once you are in Skip Mode, you can keep on skipping by pressing the Arrow keys. You don't have to use the [NumLock] + [-] combination again.
  - ◆ While Skip Mode is in effect, ordinary keyboard and mouse functions are suspended – only Skip Mode compliant keystrokes can be input. You must exit Skip Mode in order to regain normal control of the console.
3. To exit Skip Mode, press **[Esc]** or **[Spacebar]**.

## **Video DynaSync**

To invoke Video DynaSync so the CS1732B / CS1734B stores the console monitor's EDID (Extended Display Identification Data) to optimize display resolution, do the following:

1. Invoke HSM (see page 19).
2. Press **[D]**.

## **List Hotkey Settings**

To see a list of the current hotkey settings, do the following:

1. Open a text editor or word processor and place the cursor in the page window.
2. Invoke HSM (see page 19).
3. Press and release **[F4]** to display the settings.

## **USB Reset**

If the USB loses focus and needs to be reset, do the following:

1. Invoke HSM (see page 19).
2. Press and release **[F5]**.



## **Invoking the OSD / Alternate OSD Invocation Keys**

---

The OSD invocation keys (see *OSD Overview*, page 27) can be changed from tapping the Scroll Lock key twice ([Scroll Lock] [Scroll Lock]) to tapping the Ctrl key twice. To change the OSD invocation keys, do the following:

1. Invoke HSM (see page 19).
2. Press and release **[T]**.

---

**Note:** This procedure is a toggle between the two methods. To revert back to the original [Scroll Lock] [Scroll Lock] method, invoke HSM, then press and release the **T** key again.

---

## Hotkey Summary Table

[Num Lock] + [-]	[Enter]	Brings the <b>KVM</b> , <b>USB hub</b> , and <b>audio</b> focus from the port that currently has the KVM focus to the next port on the installation.
	[Port ID] [Enter]	Switches access to the computer that corresponds to that Port ID.
	[K] or [U] or [S] [Enter]	Brings only the <b>KVM</b> or <b>USB hub</b> or <b>audio</b> focus from the port that currently has it to the next port on the installation.
	[Port ID] [K] or [U] or [S]	Brings the <b>KVM</b> or <b>USB hub</b> or <b>audio</b> focus to the computer attached to the corresponding port.
	[A] [n]	Sets the Auto Scan interval to <b>n</b> seconds – where <b>n</b> is a number from 1–255.
	[A]	Invokes Auto Scan Mode.
	[←]	Invokes Skip Mode and Skips from the current port to the first accessible port previous to it.
	[→]	Invokes Skip Mode and Skips from the current port to the next accessible port.
	[↑]	Invokes Skip Mode and Skips from the current port to the last accessible port of the previous Station.
	[↓]	Invokes Skip Mode and Skips from the current port to the first accessible port of the next Station.
	[D]	Invokes Video DynaSync so the CS1732B / CS1734B stores the console monitor's EDID.
	[F4]	Lists the current OSD settings via the Paste function of a text editor, including <ul style="list-style-type: none"> <li>a) Hotkey</li> <li>b) OSD Hotkey</li> <li>c) Port OS</li> <li>d) Mouse Emulation</li> <li>e) Button Settings</li> </ul>
	[F5]	Performs USB Keyboard and Mouse reset.
	[H]	Toggles between the default and alternate HSM invocation keys.
	[T]	Toggles between the default and alternate OSD Invocation keys.

# Chapter 5

## OSD Operation

This chapter provides a complete description of the procedures involved in the OSD (On Screen Display) operation of your CS1732B / CS1734B installation.

### OSD Overview

---

The On Screen Display (OSD) is a menu driven method to handle computer control and switching operations. All procedures start from the OSD Main Screen. To pop up the Main Screen, tap the **Scroll Lock** key twice.

**Note:** You can change the Hotkey to the Ctrl key by tapping [**Ctrl**] twice (see *Invoking the OSD / Alternate OSD Invocation Keys*, page 25). The Ctrl keys must be both left, or both right.

---

### OSD Main Screen

When you invoke the OSD, a screen similar to the one below appears:

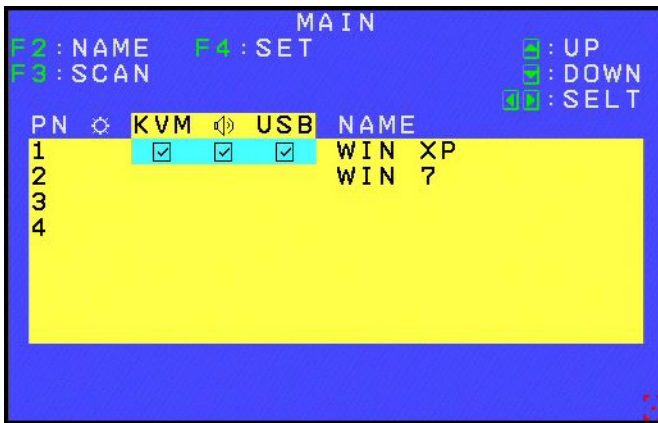

**Note:** The OSD always starts with the highlight bar at the same position it was in the last time it was closed.

---

## OSD Navigation

---

- ◆ The KVM, USB, Audio, and PN columns can be selected with the mouse. Using the mouse allows you to select single or multiple columns. Click the mouse or press **[Enter]** on your keyboard to switch KVM, Audio or USB focus to the highlighted port. The OSD will disappear briefly and a Check Box will appear on the selected port at next OSD startup.









---

**Note:** Clicking on the PN column selects the KVM, USB and Audio columns at the same time. However, simply click on the KVM, USB and Audio columns to configure them one by one.

---

- ◆ The KVM, USB, Audio, and PN columns can also be selected using the **Up** and **Down** keys on your keyboard to move the Highlight Bar down the list on the screen. When the Highlight Bar is on the port to which you want to switch KVM, Audio and USB focus, press **[Enter]** or click the left button of the mouse. The OSD will disappear briefly and a Check Box will appear on the selected port at next OSD startup.
- ◆ The **Left** and **Right** keys on your keyboard let you select the KVM, USB and Audio either individually or together. Cycle through KVM, USB, Audio or All using either the left or right keys. When the Highlight Bar is on the port to which you want to switch KVM, Audio or USB focus, press **[Enter]** or click the left button of the mouse. The OSD will disappear briefly and a Check Box will appear on the selected port at next OSD startup.
- ◆ In the Name column, use the **Up** and **Down** keys on your keyboard or the mouse to select a port. Once a port has been selected, you can edit its name after double clicking with the mouse or pressing **[F2]**.
- ◆ To exit the Main Screen/Port Display, press **[Esc]** or click the right button of the mouse. The OSD will disappear and the original computer screen will be displayed. Settings will not be stored on exit.
- ◆ To store settings on exit, press **[Enter]** or move to the cursor to the central yellow area or the Highlight Bar and double click with the left button of the mouse. Then exit as outlined above.

## OSD Main Screen Headings

PN	This column lists the Port ID numbers for all the KVM ports on the installation. The simplest method to access a particular computer is move the Highlight Bar to its corresponding port, then press [Enter].
	The computers that are powered on and are On Line have a Sun symbol in this column to indicate so.
KVM	A Check Box in this column indicates which computer has the console focus.
	A Check Box in this column indicates which computer has access to the audio.
USB	A Check Box in this column indicates which computer has access to the USB peripheral.
NAME	If a port has been given a name, it appears in this column. To edit a name, double click on the port in the NAME column and a green grid will appear in which you can key the name. Press [Enter] to store the name. The system allows for the following characters in this function: A~Z, 0~9,+,-, :, ,, [Space] and /.
 : UP	Click here to move the Highlight Bar up one item at a time.
 : DOWN	Click here to move the Highlight Bar down one item at a time.
 : PAGEUP	Click here to move the Highlight Bar up one screen at a time.
 : PAGEDOWN	Click here to move the Highlight Bar down one screen at a time.
 : SELT	Use the Left and Right keys on your keyboard to navigate through the menu options.
	This pointer indicates the position of the mouse in the OSD screen.
<input checked="" type="checkbox"/>	This check box identifies which port has the KVM / Audio / USB focus in the OSD Main Screen. For the rest of the OSD screens (i.e., Hotkey, OSD Language), this Check Box indicates the active selection.

## OSD Functions

---

OSD functions are used to configure and control the OSD. For example, you can: rapidly switch to any port; scan selected ports only; create or edit a port name; or make OSD setting adjustments.

To access an OSD function:

1. Either Click a Function Key field at the top of the Main Screen, or press a Function Key on the keyboard.
2. In the Submenus that appear make your choice either by Double Clicking it, or moving the Highlight Bar to it, then pressing **[Enter]**.
3. Press **[Esc]** to return to the previous menu level.

### **F3: SCAN**

Clicking the **F3** field or pressing **[F3]** invokes AUTO SCAN Mode. This function allows you to automatically switch among the available computers at regular intervals so that you can monitor their activity without having to take the trouble of switching yourself.

- ◆ The amount of time that each Port displays for is set with the *Scan Duration* setting under the **F4 SET** function (see *F4: SET*, page 31).
- ◆ If the scanning stops on an empty port, or one where the computer is attached but is powered Off, the monitor screen will be blank, and the mouse and keyboard will have no effect. After the *Scan Duration* time is up, the Scan function will move on to the next port.
- ◆ While Auto Scan Mode is in effect, the console will not function normally. You must exit Auto Scan Mode in order to regain control of the console.
- ◆ To exit Auto Scan Mode, press the **[Spacebar]** or **[Esc]**.

## F4: SET

This function allows you to set up your working environment. When you press **[F4]** or click on the F4 field, a screen similar to the one below appears:

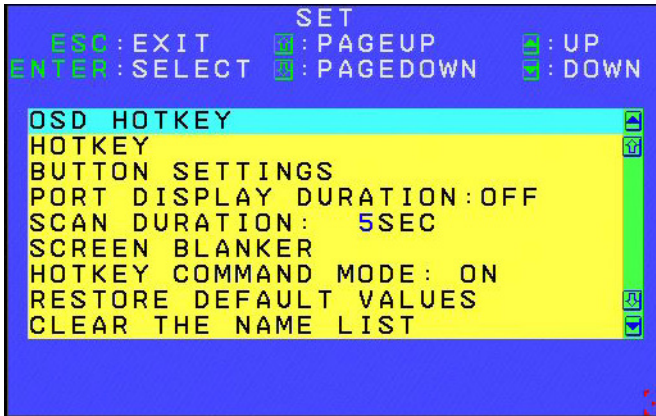

To change a setting:

1. Double click it; or move the Highlight Bar to it, and press **[Enter]**.
2. After you select an item, a submenu with further choices appears. (Press **[Esc]** to return to the previous menu level). To make a selection, either double click it; or move the Highlight Bar to it, and press **[Enter]**. A Check Box appears before the selected choice to indicate which one it is. The settings are explained in the following table:

Setting	Function
OSD HOTKEY	Selects which Hotkey activates the OSD function: <b>[Scroll Lock] [Scroll Lock] or [Ctrl] [Ctrl]</b> . Since the Ctrl key combination may conflict with programs running on the computers, the default is the Scroll Lock combination.
HOTKEY	Selects which Hotkey activates the Hotkey function (for keyboard port operation. See Chapter 4: Keyboard Port Operation): <b>[Num Lock] + [-] or [Ctrl] + [F12]</b> [Num Lock] + [-] is the default setting.

*(Continues on next page.)*

*(Continued from previous page.)*

Setting	Function
BUTTON SETTINGS	<p>Sets the Front Panel Pushbutton Switching Operation Setting:</p> <p>MODE 1 (Default Setting):</p> <ol style="list-style-type: none"> <li>1. Press a pushbutton once to bring the KVM, Audio and USB focus simultaneously to the computer attached to its corresponding port (in 2 secs).</li> <li>2. Press a pushbutton twice to bring the Audio focus to the computer attached to its corresponding port (in 2 secs).</li> <li>3. Press a pushbutton for longer than 2 seconds to bring only the KVM focus to the computer attached to its corresponding port.</li> <li>4. Press pushbuttons 1 and 2 simultaneously for 2 seconds to start Auto Scan Mode.</li> <li>5. Press pushbuttons 3 and 4 simultaneously for 2 seconds to perform a keyboard and mouse reset. (CS1734B only).</li> </ol> <p>MODE 2 (Alternative Setting)</p> <ol style="list-style-type: none"> <li>1. Press a pushbutton once to bring only the KVM focus to the computer attached to its corresponding port (in 2 secs).</li> <li>2. Press a pushbutton twice to bring the audio focus to the computer attached to its corresponding port (in 2 secs).</li> <li>3. Press a pushbutton for longer than 2 seconds to bring the KVM, Audio and USB focus simultaneously to the computer attached to its corresponding port.</li> <li>4. Press pushbuttons 1 and 2 simultaneously for 2 seconds to start Auto Scan Mode.</li> <li>5. Press pushbuttons 3 and 4 simultaneously for 2 seconds to perform a keyboard and mouse reset. (CS1734B only)</li> </ol>
PORT DISPLAY DURATION	<p>Determines how long a Port displays on the monitor after a port change. The choices are User Defined (from 0–255 secs), the default value is 0, which shows as OFF. If you specify 5 and press <b>[Enter]</b>, the Port Display Duration will be saved as 5 SEC.</p> <p><b>Note:</b> A value of 0 (zero) will disable the Port Display Duration function. This shows as OFF.</p>
SCAN DURATION	<p>Determines how long the focus dwells on each port as it cycles through the selected ports in Auto Scan Mode. Key in a value from 1–255 seconds (the default is 5 secs) and press <b>[Enter]</b> to save the setting.</p>
SCREEN BLANKER	<p>SET TIMEOUT: OFF and SCREEN LOCK: OFF is the default setting.</p> <p>Settings steps:</p> <ol style="list-style-type: none"> <li>1. SET TIMEOUT to ON. Key in a value from 1–30 minutes. If SET TIMEOUT is set to OFF, you will not be able to set the SCREEN BLANKER.</li> <li>2. Set the SCREEN BLANKER password. Key in a password that is 8 characters long (allowed characters are A–Z and 0–9). If you have not changed the default password, you can press <b>[Enter]</b> to cancel SCREEN LOCK.</li> <li>3. Set the SCREEN LOCK to ON. Key in <b>Y</b>. If the SCREEN LOCK function is set to ON, a password is needed to the leave the SCREEN BLANKER mode and return to the OSD.</li> </ol>

*(Continues on next page.)*



(Continued from previous page.)

Setting	Function
HOTKEY COMMAND MODE	Enables / Disables the Hotkey Command function in case a conflict with programs running on the computer occurs.
RESTORE DEFAULT VALUES	Used to undo all the changes and return to the factory default settings (see <i>Factory Default Settings</i> , page 44) except for the NAMES settings that were assigned to the ports, which are saved.
CLEAR THE NAME LIST	This function is similar to the Restore Default Values function with an extra function of clearing all the NAMES in addition to undoing all changes and returning the setup to the factory default settings.
ACTIVATE BEEPER	Enables / Disables the Beeper function. The default setting is ON. When activated, the beeper sounds whenever a port is changed; when activating the Auto Scan function; or an invalid entry is made on an OSD menu.
FIRMWARE UPGRADE	In order to upgrade the CS1732B / CS1734B's firmware, connect the Upgrade Cable as prompted in the Firmware Upgrade main menu. Key in Y (Yes) and then press <b>[Enter]</b> . A FIRMWARE UPGRADE IN PROGRESS message will appear on the screen.
PORT OS	Sets the OS for PC ports to be PC, SUN, MAC or SPC* mode and allows users to use special SUN, MAC or other OS keyboard keys. Use the Up and Down Arrow keys or click with the mouse to select the port. You can also use the Spacebar or double click with mouse to change the OS for each port. <b>Note:</b> SPC mode supports other OS.
MOUSE EMULATION	Enables / Disables the emulation function of the Console mouse port. The default setting is ON. If you disable this function, it supports full mouse driver. <b>Note:</b> Only USB console mouse to USB PC pass through is supported; USB console mouse to PS/2 PC does not support full mouse driver.
MOUSE SWITCHING FUNCTION	Enables / Disable the mouse port-switching function. The default setting is OFF. If this function is enabled, the user can switch ports via by double-clicking on the mouse wheel. See <i>Mouse Port Selection</i> , page 16 for full details.
OSD LANGUAGE	The OSD display supports English, Chinese (Simplified and Traditional), Japanese, and German. The default setting is ENGLISH.

This Page Intentionally Left Blank









# Chapter 6

## Keyboard Emulation

### Mac Keyboard

---

The PC compatible (101/104 key) keyboard can emulate the functions of the Mac keyboard. The emulation mappings are listed in the table below.

PC Keyboard	Mac Keyboard
[Shift]	Shift
[Ctrl]	Ctrl
	
[Ctrl] [1]	
[Ctrl] [2]	
[Ctrl] [3]	
[Ctrl] [4]	
[Alt]	Alt
[Print Screen]	F13
[Scroll Lock]	F14
	=
[Enter]	Return
[Backspace]	Delete
[Insert]	Help
[Ctrl] 	F15







---

**Note:** When using key combinations, press and release the first key (Ctrl), then press and release the activation key.

---

## Sun Keyboard

The PC compatible (101/104 key) keyboard can emulate the functions of the Sun keyboard when the Control key [Ctrl] is used in conjunction with other keys. The corresponding functions are shown in the table below.

PC Keyboard	Sun Keyboard
[Ctrl] [T]	Stop
[Ctrl] [F2]	Again
[Ctrl] [F3]	Props
[Ctrl] [F4]	Undo
[Ctrl] [F5]	Front
[Ctrl] [F6]	Copy
[Ctrl] [F7]	Open
[Ctrl] [F8]	Paste
[Ctrl] [F9]	Find
[Ctrl] [F10]	Cut
[Ctrl] [1]	
[Ctrl] [2]	
[Ctrl] [3]	
[Ctrl] [4]	
[Ctrl] [H]	Help
	Compose
	

**Note:** When using key combinations, press and release the first key (Ctrl), then press and release the activation key.

# Chapter 7

## The Firmware Upgrade Utility

The Windows-based Firmware Upgrade Utility (FWUpgrade.exe) provides a smooth, automated process for upgrading the KVM switch's firmware.

The Utility comes as part of a Firmware Upgrade Package that is specific for each device. New firmware upgrade packages are posted on our web site as new firmware revisions become available.

<http://www.aten.com>

### Before you Begin

---

1. From a computer that is not part of the KVM installation go to our Internet support site and choose the model name of your device (CS1732B / CS1734B) to get a list of available Firmware Upgrade Packages.
2. Choose the Firmware Upgrade Package you want to install (usually the most recent), and download it to your computer.
3. Use the *Firmware Upgrade Cable* provided to connect a COM port on your computer to the *Firmware Upgrade Port* of your switch.

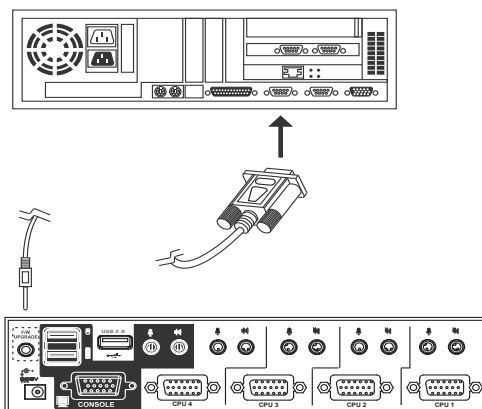

4. Shut down the computers on your CS1732B / CS1734B installation.
5. Invoke Firmware Upgrade Mode (see *FIRMWARE UPGRADE*, page 33).  
The front panel LEDs flash together to indicate Firmware Upgrade Mode is in effect.

## Starting the Upgrade

1. Run the downloaded Firmware Upgrade Package file – either by double clicking the file icon, or by opening a command line and entering the full path to it. The *Firmware Upgrade Utility* Welcome screen appears:

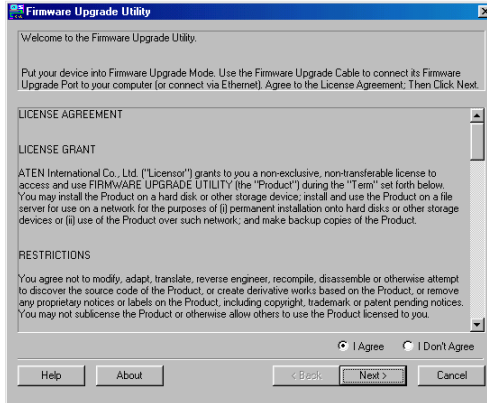

**Note:** The screens shown in this section are for reference only.

2. Read the License Agreement (enable the *I Agree* radio button).
3. Click **Next**. The Firmware Upgrade Utility main screen appears:

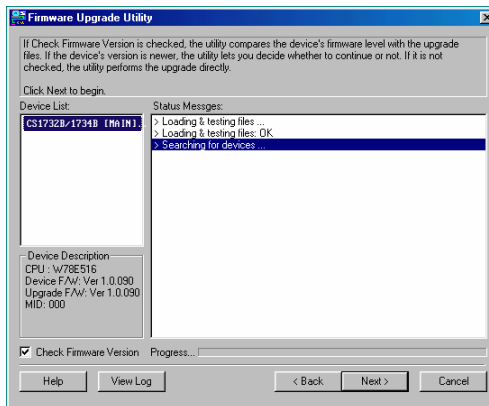

The Utility inspects your installation. All the devices capable of being upgraded by the package are listed in the *Device List* panel.

- After you have made your device selection(s), Click **Next** to perform the upgrade.

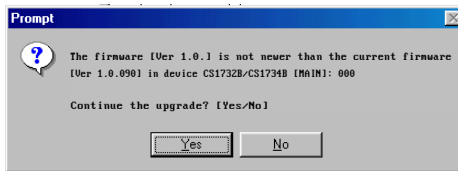

If you enabled *Check Firmware Version*, the Utility compares the device's firmware level with that of the upgrade files. If it finds that the device's version is higher than the upgrade version, it brings up a dialog box informing you of the situation and gives you the option to Continue or Cancel.

If you didn't enable *Check Firmware Version*, the Utility installs the upgrade files without checking whether they are a higher level, or not.

As the Upgrade proceeds status messages appear in the Status Messages panel, and the progress toward completion is shown on the *Progress* bar.

## Upgrade Succeeded

After the upgrade has completed, a screen appears to inform you that the procedure was successful:

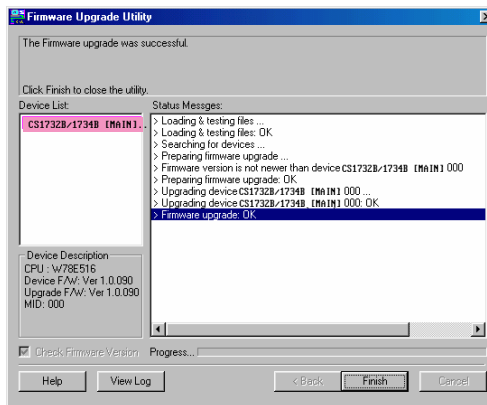

Click **Finish** to close the Firmware Upgrade Utility.

After a successful completion, the switches exit Firmware Upgrade Mode, and reset themselves.

## Upgrade Failed

---

### Shorting the Mainboard Jumper

If the *Upgrade Succeeded* screen doesn't appear, it means that the upgrade failed to complete successfully, in which case you should do the following:

1. Power off the CS1732B / CS1734B and remove its housing.
2. Using a jumper cap, short the jumper on the mainboard labeled J14. The diagrams indicate the jumper location on the CS1732B / CS1734B boards:

#### **CS1732B**

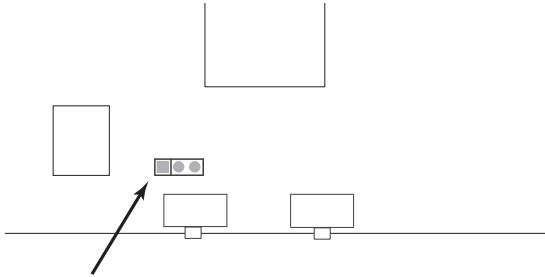

#### **CS1734B**

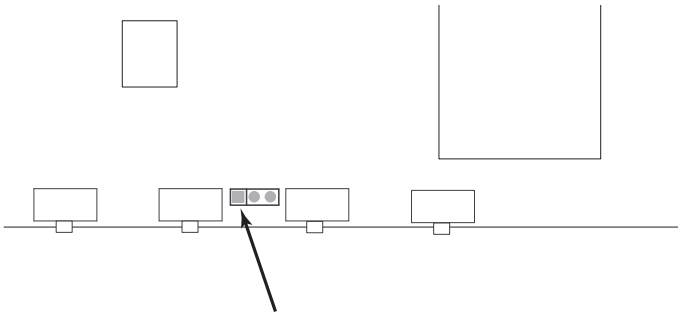

3. Power on the CS1732B / CS1734B. It will now work with the factory default firmware.
4. Do the firmware upgrade procedure again.
5. After the upgrade procedure completes, power off the switch, remove the jumper cap from J14, close the housing, and power the CS1732B / CS1734B on again.



# Appendix

## Safety Instructions

---

- ◆ Read all of these instructions. Save them for future reference.
- ◆ Follow all warnings and instructions marked on the device.
- ◆ This product is for indoor use only.
- ◆ Do not place the device on any unstable surface (cart, stand, table, etc.). If the device falls, serious damage will result.
- ◆ Do not use the device near water.
- ◆ Do not place the device near, or over, radiators or heat registers.
- ◆ The device cabinet is provided with slots and openings to allow for adequate ventilation. To ensure reliable operation, and to protect against overheating, these openings must never be blocked or covered.
- ◆ The device should never be placed on a soft surface (bed, sofa, rug, etc.) as this will block its ventilation openings. Likewise, the device should not be placed in a built in enclosure unless adequate ventilation has been provided.
- ◆ Never spill liquid of any kind on the device.
- ◆ Unplug the device from the wall outlet before cleaning. Do not use liquid or aerosol cleaners. Use a damp cloth for cleaning.
- ◆ The device should be operated from the type of power source indicated on the marking label. If you are not sure of the type of power available, consult your dealer or local power company.
- ◆ Do not allow anything to rest on the power cord or cables. Route the power cord and cables so that they cannot be stepped on or tripped over.
- ◆ If an extension cord is used with this device make sure that the total of the ampere ratings of all products used on this cord does not exceed the extension cord ampere rating. Make sure that the total of all products plugged into the wall outlet does not exceed 15 amperes.
- ◆ Position system cables and power cables carefully; Be sure that nothing rests on any cables.
- ◆ When connecting or disconnecting power to hot-pluggable power supplies, observe the following guidelines:
  - ◆ Install the power supply before connecting the power cable to the power supply.

- ◆ Unplug the power cable before removing the power supply.
- ◆ If the system has multiple sources of power, disconnect power from the system by unplugging all power cables from the power supplies.
- ◆ Never push objects of any kind into or through cabinet slots. They may touch dangerous voltage points or short out parts resulting in a risk of fire or electrical shock.
- ◆ Do not attempt to service the device yourself. Refer all servicing to qualified service personnel.
- ◆ If the following conditions occur, unplug the device from the wall outlet and bring it to qualified service personnel for repair.
  - ◆ The power cord or plug has become damaged or frayed.
  - ◆ Liquid has been spilled into the device.
  - ◆ The device has been exposed to rain or water.
  - ◆ The device has been dropped, or the cabinet has been damaged.
  - ◆ The device exhibits a distinct change in performance, indicating a need for service.
  - ◆ The device does not operate normally when the operating instructions are followed.
- ◆ Only adjust those controls that are covered in the operating instructions. Improper adjustment of other controls may result in damage that will require extensive work by a qualified technician to repair.

## Technical Support

---

### International

- ◆ For online technical support – including troubleshooting, documentation, and software updates: <http://eservice.aten.com>
- ◆ For telephone support, see *Telephone Support*, page iii.

### North America

Email Support		<a href="mailto:support@aten-usa.com">support@aten-usa.com</a>
Online Technical Support	Troubleshooting Documentation Software Updates	<a href="http://www.aten-usa.com/support">http://www.aten-usa.com/support</a>
Telephone Support		1-888-999-ATEN ext 4988

When you contact us, please have the following information ready beforehand:

- ◆ Product model number, serial number, and date of purchase.
- ◆ Your computer configuration, including operating system, revision level, expansion cards, and software.
- ◆ Any error messages displayed at the time the error occurred.
- ◆ The sequence of operations that led up to the error.
- ◆ Any other information you feel may be of help.

## Factory Default Settings

---

### Pushbuttons and Hotkeys

Setting	Default
Port Switching	[Number Lock] [-] [Enter]
Invoking HSM	[Number Lock] [-]
Auto Scan Interval	5 seconds
Port Switching Keys	Enabled

### OSD

Setting	Default	
OSD Hotkey	[Scroll Lock] [Scroll Lock]	
Keyboard Port Hotkey	[Num Lock] + [-]	
Button Settings	Mode 1	
Port Display Duration	0 Seconds	
Scan Duration	5 Seconds	
Screen Blanker	Set Timeout	OFF (Disabled)
	Screen Blanker Password	"Blank"
	Screen Lock	OFF (Disabled)
Hotkey Command Mode	ON	
Activate Beeper	ON	
Port OS	PC	
Mouse Emulation	ON	
Mouse Switching Function	OFF	
OSD Language	ENGLISH	

## Specifications

Function		CS1732B	CS1734B		
Computer Connections		2	4		
Port Selection		OSD; Hotkeys; Pushbuttons, Mouse			
Connectors	Console Ports	KB	1 x USB Type A F (Black)		
		Video	1 x HDB-15 F (Blue)		
		Mouse	1 x USB Type A F (Black)		
		Speaker	2 x Mini Stereo Jack F (Green)		
		Mic.	2 x Mini Stereo Jack F (Pink)		
	KVM Ports	KB	2 x SPHD-15 F (Yellow)	4 x SPHD-15 F (Yellow)	
		Video			
		Mouse	2 x Mini Stereo Jack F (Green)	4 x Mini Stereo Jack F (Green)	
		Speaker			
		Mic.			
	F/W Upgrade		1 x 4-conductor 3.5 mm Jack (Black)		
	Power		1 x DC Jack (Black)		
	USB Hub		2 x USB Type A F (White; 1 x front panel, 1 x rear panel)		
Switches	Selected	2 x Pushbutton	4 x Pushbutton		
LEDs	On Line / Selected	2 (Orange)	4 (Orange)		
	USB Link	2 (Green)	4 (Green)		
Emulation	Keyboard / Mouse	PS/2; USB			
Video		2048 x 1536 @ 60Hz; DDC2B			
Scan Interval		1–255 seconds (Default: 5; Disabled: 0)			
Power Consumption		DC5.3V/3.1W (max.)	DC5.3V/3.4W (max.)		
Environment	Operating Temp.	0–50° C			
	Storage Temp.	-20–60° C			
	Humidity	0–80% RH, Non-condensing			
Physical Properties	Housing	Metal			
	Weight	0.55 kg	0.78 kg		
	Dimensions	13.98 x 8.80 x 5.55 cm	21.00 x 8.80 x 5.55 cm		

## Troubleshooting

Operation problems can be due to a variety of causes. The first step in solving them is to make sure that all cables are securely attached and seated completely in their sockets.

In addition, updating the product's firmware may solve problems that have been discovered and resolved since the prior version was released. If your product is not running the latest firmware version, we strongly recommend that you upgrade. See *The Firmware Upgrade Utility*, page 37, for details.

Symptom	Possible Cause	Action
Mouse and/or keyboard not responding.	Improper mouse and/or keyboard reset.	Unplug the cable(s) from the console port(s), then plug it/them back in.
	KVM switch needs to be reset.	Power off all devices on the installation (see safety note, top of page 11); power off the KVM switch; wait five seconds; then power up
USB devices not responding.	USB ports need to reset.	Unplug the device's USB cable from the USB port on the switch's rear panel, then plug it back in.
		Use the USB reset hotkey combination (see [F5], page 26) to reset the USB ports.
		<ol style="list-style-type: none"> <li>1. Change the OS by selecting SPC mode in the PORT OS settings (see <i>PORT OS</i>, page 33)</li> </ol> <p><b>Note:</b> We suggest Linux Kernel 2.6 or higher.</p> <ol style="list-style-type: none"> <li>2. If the OS does not support USB 2.0, change to the PS/2 interface. This will require cables that are not provided with the CS1732B / CS1734B package. See <i>PS/2 cable information under Cables</i>, page 4 for details.</li> </ol>
Device not recognized (Windows).	Windows timing problem.	<ol style="list-style-type: none"> <li>1. Unplug the KVM cable from the computer's USB port.</li> <li>2. Go into Windows' <i>System Settings</i> and remove the <i>Unknown Device</i> entry.</li> <li>3. Plug the KVM cable back in. Windows will now recognize the device.</li> </ol>
Cannot invoke OSD	Keyboard is incompatible with Scroll Lock OSD invocation	Switch to the other OSD invocation mode. See <i>Invoking the OSD / Alternate OSD Invocation Keys</i> , page 25.

## About SPHD Connectors

---



This product uses SPHD connectors for its KVM and/or Console ports. We have specifically modified the shape of these connectors so that only KVM cables that we have designed to work with this product can be connected.

## Limited Warranty

---

IN NO EVENT SHALL THE DIRECT VENDOR'S LIABILITY EXCEED THE PRICE PAID FOR THE PRODUCT FROM THE DIRECT, INDIRECT, SPECIAL, INCIDENTAL OR CONSEQUENTIAL DAMAGES RESULTING FROM THE USE OF THE PRODUCT, DISK OR ITS DOCUMENTATION.

The direct vendor makes no warranty or representation, expressed, implied, or statutory with respect to the contents or use of this documentation, and specially disclaims its quality, performance, merchantability, or fitness for any particular purpose.

The direct vendor also reserves the right to revise or update the device or documentation without obligation to notify any individual or entity of such revisions, or update. For further inquiries please contact your direct vendor.

Manual Part No. PAPE-0233-AT5G



Printing Date: 2014-04-08

© Copyright 2008–2014 ATEN® International Co., Ltd.

ATEN and the ATEN logo are registered trademarks of ATEN International Co., Ltd. All rights reserved.  
All other brand names and trademarks are the registered property of their respective owners.