

Atlona HDBaseT Extender Family

AT-DVITX-RSNET & AT-DVIRX-RSNET



User Manual

Table of Contents

1. Introduction	3
2. Package Contents	3
3. Features	3
4. Before You Start	3
5. Panel Descriptions	
a. Front Panel	4
b. Rear Panel	4
6. Captive Screw Connection	5
7. Connection and Installation	6
8. Specifications	7
9. Safety Information	8
10. Warranty	9
11. Atlona Product Registration	10

Introduction

Atlona's HDBaseT DVI extenders are engineered for high-resolution electronics with DVI connectors. Using HDBaseT technology the DVI extenders combine embedded audio, digital video, power (PoC^c™), Ethernet, RS-232, and IR control up to 328 feet (100 meters) over a single category cable.

Package Contents

- 1 x AT-DVIXX-RSNET
- 1 x 24V/2.7A DC Power Supply (transmitter only)
- 2 x Female Captive Screw Connector (2 pin: power and 5 pin: IR)
- 1 x Pair of wall mount ears
- 1 x User Manual

Features

- Extends IR and audio/visual content up to 328ft @ 1080p over a single category cable
- Supports 4Kx2K pass through
- Captive screw IR I/O ports for emitting and receiving IR control signals for use with IR remote controls and 3rd party control boxes
- PoC^c (Power over Category cable) feature removes the need for a power supply at the receiver
- Lossy and lossless multi-channel audio formats pass through (including Dolby TrueHD and DTS-HD Master Audio)
- When using an HDMI to DVI adaptor, HDMI Electronics will transmit a full range of HDMI signals including audio (if it is embedded in the video signal)
- Full 3D pass through
- HDCP compliant

Before you start

- Make sure when connecting the category cables a 568B termination method is used
- Avoid using patch panels and wall plates during initial set up and testing
- When installing the extenders **DO NOT:**
 - Cover the vents
 - Install in a wall
 - Install in an area without adequate air ventilation

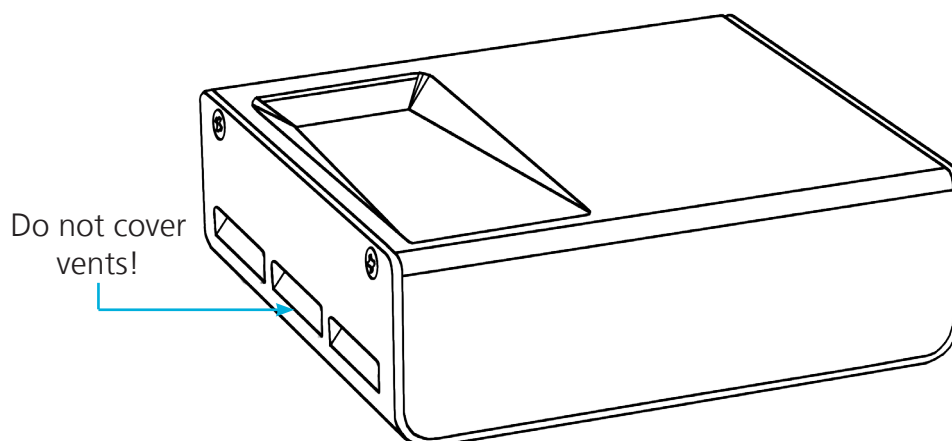

NOTE: Product is not dual link DVI compatible

Panel Description

Transmitter

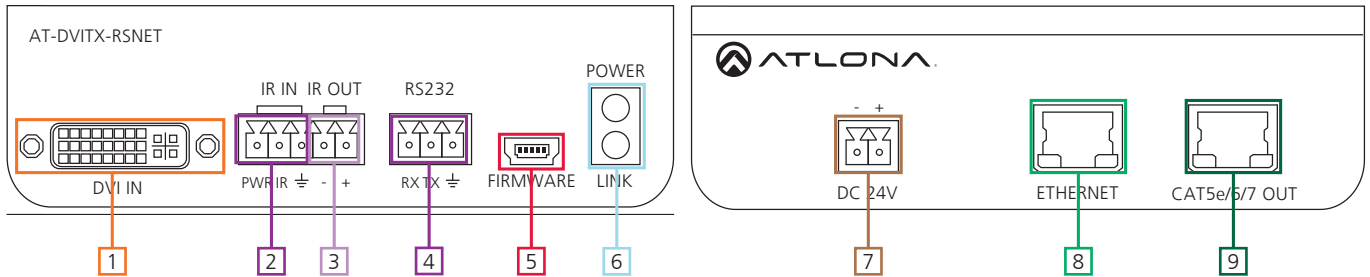

1. **DVI IN Port:** Connect DVI or HDMI (with adapter) source here. *Not dual link DVI compatible*
2. **IR IN Port:** Connect an IR receiver or IR control box to this port.
3. **IR OUT Port:** Connect the IR Emitter or IR control box to this port.
4. **RS232:** Bidirectional RS-232, send signal to or from a control system or PC.
5. **Firmware Update Port:** Use a Mini USB to USB A cable to connect to a Windows computer for updating.
6. **Yellow Link LED:** Signal Indicator for the CAT5e/6/7 OUT port. LED will remain solid, unless there is an issue with the cable or signal, then it will blink.
Green Power LED: Power indicator. If plugged in light will remain solid. If LED starts blinking power is intermittent or there is a problem with the cable. If LED is off, no power is passing to the receiver (check your outlet or the power cable).
7. **DC 24V Port:** Connect included captive screw power adapter here.
 **Be certain the wire is properly polarized
8. **Ethernet:** Send signal to a display or source from a network
9. **CAT5e/6/7 OUT Port:** Connect a category cable from here to a compatible receiver.

Receiver

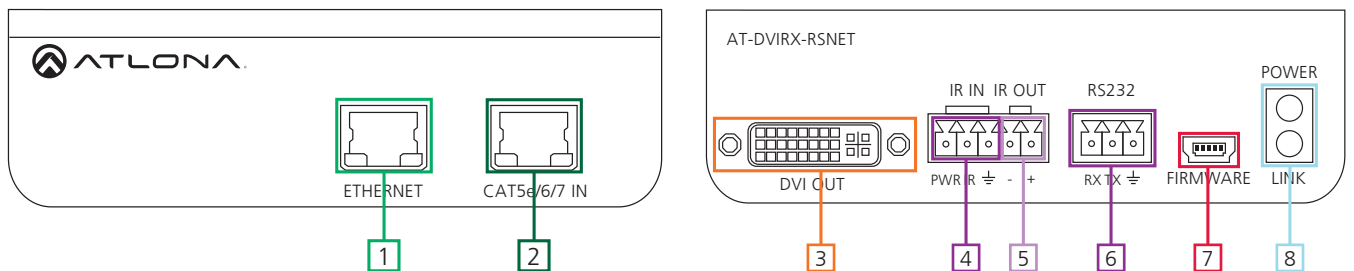

1. **Ethernet:** Send signal to a display or source from a network.
2. **CAT5e/6/7 IN Port:** Connect a category cable from a compatible transmitter to this port.
3. **DVI OUT Port:** Connect to DVI or HDMI (with adapter) display. *Not dual link DVI compatible*
4. **IR IN Port:** Connect the IR receiver to this port.
5. **IR OUT Port:** Connect the IR Emitter to this port.
6. **RS232:** Bidirectional RS-232 send signal to or from a control system or PC.
7. **Firmware Update Port:** Use a Mini USB to USB cable to connect to a Windows computer for updating.
8. **Yellow Link LED:** Signal Indicator for the CAT5e/6/7 OUT port. LED will remain solid, unless there is an issue with the cable or signal, then it will blink.
Green Power LED: Power indicator. If plugged in light will remain solid. If LED starts blinking power is intermittent or there is a problem with the cable. If LED is off, no power is passing to the receiver (check your outlet or the power cable).

Captive Screw

Captive screw connectors are used on the DVI Extenders. The captive screw connectors allow you to cut cables down to a suitable length, reducing cable clutter, and provides a more reliable connection.

Connecting

When connecting the cables to the female captive screw connector it is important that the wires be terminated correctly. The female captive screw connector (see picture A) has a contact plate at the top and must have the wires touching it for signal to pass. When wired correctly (see picture B) the signal will pass, incorrectly (see picture C) no signal will pass.

The captive screw connectors have a contact bar that is moved to compress the wire to the top contact plate. Use the screws at the top of the connector to compress the wire against the contact plate.



Clockwise

Turn the screws clockwise to raise the contact bar to the upper contact plate and hold the wires in place.



Counter Clockwise

Turn the screws counter clockwise to lower the contact bar to release the wires.



For your convenience the cables do not come pre-terminated. Each item, whether it's an IR receiver (picture 1), IR emitter (picture 2), or power cable (picture 3), will have wires exposed. Each wire is encased in a different colored jacket. Female captive screw connectors are included: Power (see picture 4) and IR (see picture 5).

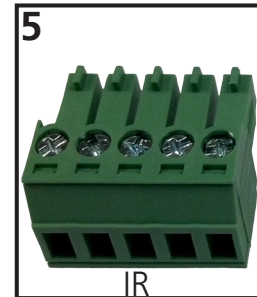
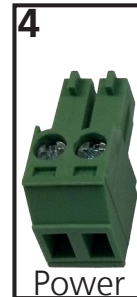
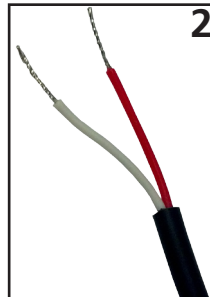

IR pin outs have been included for the included IR emitter and IR receiver (see picture 6 & 7). The wires are colored for each pin (see picture 8 and 9).

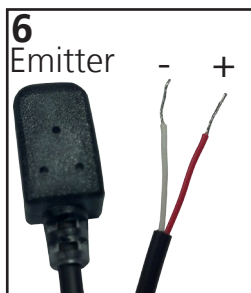

White: - Red: +

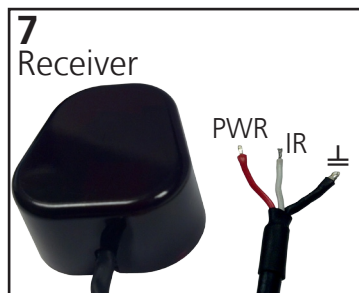

Red: PWR White: IR Black: \perp

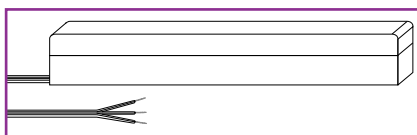
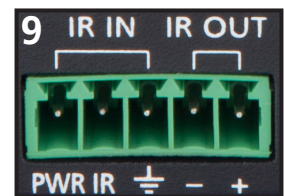
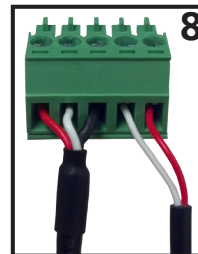

For greater distance and IR rejection from plasma, CFL, and LED panels, purchase the AT-IRX-CS (IR receiver) through atlona.com
Includes black, silver, and white bezels.

To ensure the power cable isn't too long, a captive screw connector has been included. The pin out (see picture 10) and the wire configuration (see picture 11 and 12) are shown below. (Power used with transmitters only)

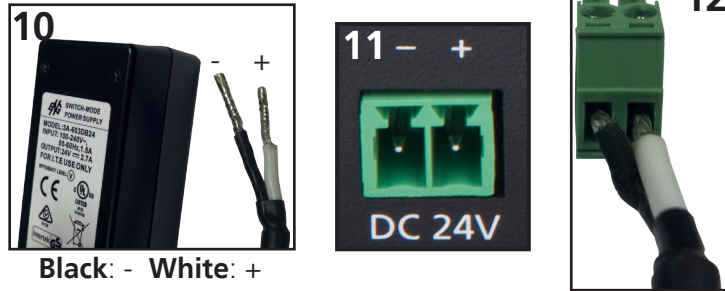

Connection and Installation

Note: When installing the extenders, do not install in an enclosed area or cover the vents. Doing so may result in damage to the product and/or area surrounding it.

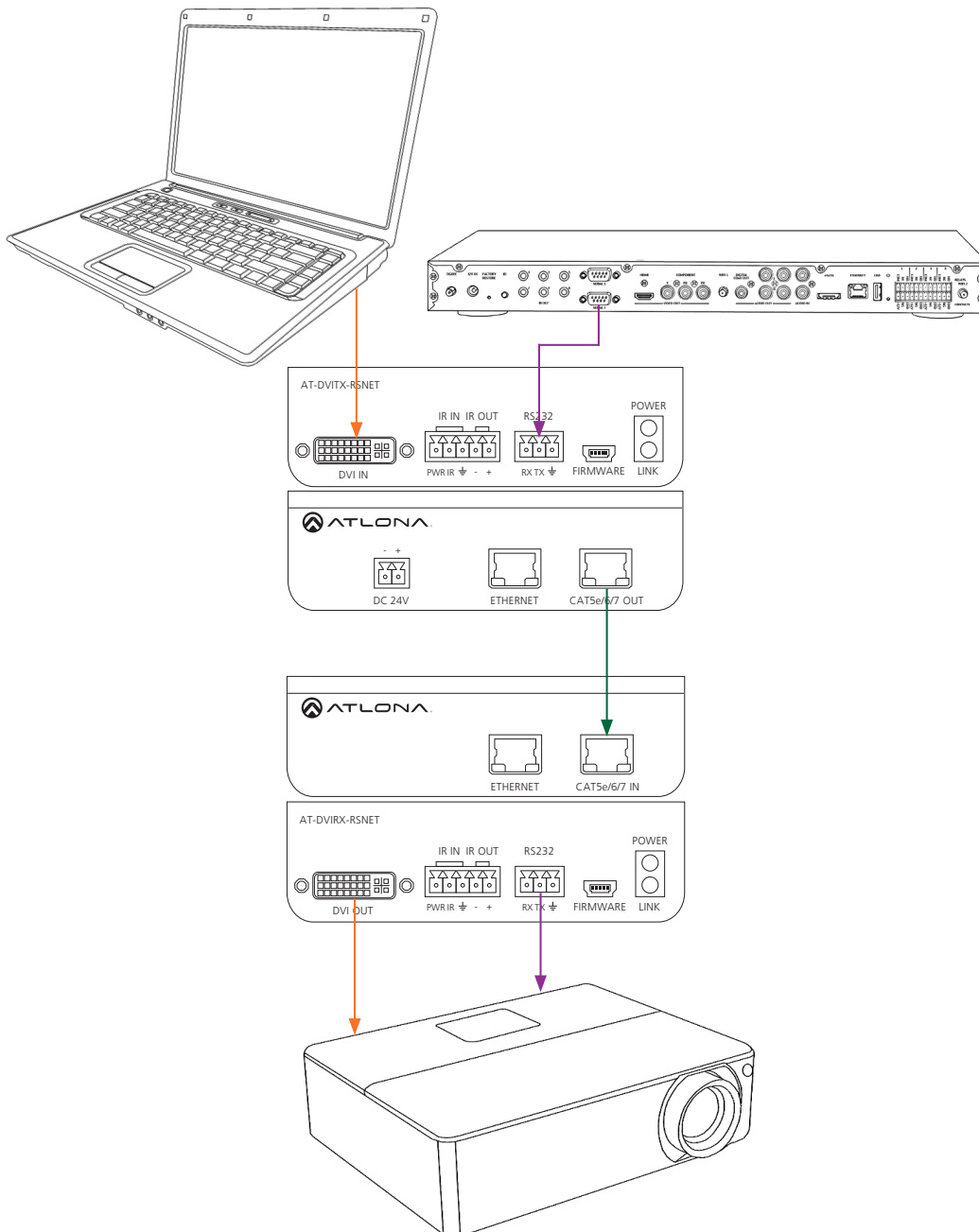

Specifications

Bandwidth	10.2Gbps	
Ports Video input Video output IR input IR output Firmware update Power	AT-DVITX-RSNET 1 x DVI-D 1 x RJ45 1 x Mini USB 1 x Captive Screw	AT-DVIRX-RSNET 1 x RJ45 1 x DVI-D 1 x Captive Screw 1 x Captive Screw 1 x Mini USB
Power Consumption	9.1W	
Audio	Passes embedded audio up to Dolby TrueHD or DTS-HD Master Audio	
Resolution	Video: up to 4Kx2K VESA: up to 1920x1200	
Distance	328 feet 100 meters	
Dimensions	1.5 x 5 x 4 (inch) 38 x 127 x 102 (mm)	
Weight	0.44 lbs 0.20 kg	
Temperature	Operating 32°F to 104°F 0°C to 40°C	Storage -4°F to 140°F 20°C to 60°C
Certifications	CE, FCC B, RoHS, cULus for power supplies	

NOTE: Product is not dual link DVI compatible

Safety Information

Safeguards



To reduce the risk of electric shock, do not expose this product to rain or moisture



Do not modify the wall plug. Doing so will void the warranty and safety features.



If the wall plug does not fit into your local power socket, hire an electrician to replace your obsolete socket.



This equipment should be installed near the socket outlet and the device should be easily accessible in the case it requires disconnection.

Precautions

FCC regulations state that any unauthorized changes or modifications to this equipment, not expressly approved by the manufacturer, could void the user's authority to operate this equipment.

Operate this product using only the included external power supply. Use of other power supplies could impair performance, damage the product, or cause fires.

In the event of an electrostatic discharge this device may automatically turn off. If this occurs, unplug the device and plug it back in.

Protect and route power cords so they will not be stepped on or pinched by anything placed on or against them. Be especially careful of plug-ins or cord exit points from this product.

Avoid excessive humidity, sudden temperature changes or temperature extremes.

Keep this product away from wet locations such as bathtubs, sinks, laundries, wet basements, fish tanks, and swimming pools.

Use only accessories recommended by Atlona to avoid fire, shock, or other hazards.

Unplug the product before cleaning. Use a damp cloth for cleaning and not cleaning fluid or aerosols. Such products could enter the unit and cause damage, fire, or electric shock. Some substances may also mar the finish of the product.

Never open, remove unit panels, or make any adjustments not described in this manual. Attempting to do so could expose you to dangerous electrical shock or other hazards. It may also cause damage to your product. Opening the product will void the warranty.

Do not attempt to service the unit. Disconnect the product and contact your authorized Atlona reseller or contact Atlona directly.

Atlona, Inc. ("Atlona") Limited Product Warranty Policy

Coverage

Atlona warrants its products will substantially perform to their published specifications and will be free from defects in materials and workmanship under normal use, conditions and service.

Under its Limited Product Warranty, Atlona, at its sole discretion, will either:

- A) repair or facilitate the repair of defective products within a reasonable period of time, restore products to their proper operating condition and return defective products free of any charge for necessary parts, labor and shipping
- OR**
- B) replace and return, free of charge, any defective products with direct replacement or with similar products deemed by Atlona to perform substantially the same function as the original products
- OR**
- C) refund the pro-rated value based on the remaining term of the warranty period, not to exceed MSRP, in cases where products are beyond repair and/or no direct or substantially similar replacement products exist.

Repair, replacement or refund of Atlona's products is the purchaser's exclusive remedy and Atlona's liability does not extend to any other damages, incidental, consequential or otherwise.

This Limited Product Warranty extends to the original end-user purchaser of Atlona's products and is non-transferrable to any subsequent purchaser(s) or owner(s) of these products.

Coverage Periods

Atlona's Limited Product Warranty Period begins on the date of purchase by the end-purchaser. The date contained on the end-purchaser's sales or delivery receipt is the proof purchase date.

Limited Product Warranty Terms – New Products

- 10 years from proof of purchase date for hardware/electronics products purchased on or after June 1, 2013
- 3 years from proof of purchase date for hardware/electronics products purchased before June 1, 2013
- Lifetime Limited Product Warranty for all cable products

Limited Product Warranty Terms – Refurbished (B-Stock) Products

- 3 years from proof of purchase date for all Refurbished (B-Stock) hardware and electronic products purchased on or after June 1, 2013

Remedy

Atlona recommends that end-purchasers contact their authorized Atlona dealer or reseller from whom they purchased their products. Atlona can also be contacted directly. Visit www.atlona.com for Atlona's contact information and hours of operation. Atlona requires that a dated sales or delivery receipt from an authorized dealer, reseller or end-purchaser is provided before Atlona extends its warranty services. Additionally, a return merchandise authorization (RMA) and/or case number, is required to be obtained from Atlona in advance of returns.

Atlona requires that products returned are properly packed, preferably in the original carton, for shipping. Cartons not bearing a return authorization or case number will be refused. Atlona, at its sole discretion, reserves the right to reject any products received without advanced authorization. Authorizations can be requested by calling 1-877-536-3976 (US toll free) or 1-408-962-0515 (US/international) or via Atlona's website at www.atlona.com.

Exclusions

This Limited Product Warranty excludes:

- Damage, deterioration or malfunction caused by any alteration, modification, improper use, neglect, improper packing or shipping (such claims must be presented to the carrier), lightning, power surges, or other acts of nature.
- Damage, deterioration or malfunction resulting from the installation or removal of this product from any installation, any unauthorized tampering with this product, any repairs attempted by anyone unauthorized by Atlona to make such repairs, or any other cause which does not relate directly to a defect in materials and/or workmanship of this product.
- Equipment enclosures, cables, power supplies, batteries, LCD displays, and any accessories used in conjunction with the product(s).
- Products purchased from unauthorized distributors, dealers, resellers, auction websites and similar unauthorized channels of distribution.

Disclaimers

This Limited Product Warranty does not imply that the electronic components contained within Atlona's products will not become obsolete nor does it imply Atlona products or their electronic components will remain compatible with any other current product, technology or any future products or technologies in which Atlona's products may be used in conjunction with. Atlona, at its sole discretion, reserves the right not to extend its warranty offering in instances arising outside its normal course of business including, but not limited to, damage inflicted to its products from acts of god.

Limitation on Liability

The maximum liability of Atlona under this limited product warranty shall not exceed the original Atlona MSRP for its products. To the maximum extent permitted by law, Atlona is not responsible for the direct, special, incidental or consequential damages resulting from any breach of warranty or condition, or under any other legal theory. Some countries, districts or states do not allow the exclusion or limitation of relief, special, incidental, consequential or indirect damages, or the limitation of liability to specified amounts, so the above limitations or exclusions may not apply to you.

Exclusive Remedy

To the maximum extent permitted by law, this limited product warranty and the remedies set forth above are exclusive and in lieu of all other warranties, remedies and conditions, whether oral or written, express or implied. To the maximum extent permitted by law, Atlona specifically disclaims all implied warranties, including, without limitation, warranties of merchantability and fitness for a particular purpose. If Atlona cannot lawfully disclaim or exclude implied warranties under applicable law, then all implied warranties covering its products including warranties of merchantability and fitness for a particular purpose, shall provide to its products under applicable law. If any product to which this limited warranty applies is a "Consumer Product" under the Magnuson-Moss Warranty Act (15 U.S.C.A. §2301, ET SEQ.) or other applicable law, the foregoing disclaimer of implied warranties shall not apply, and all implied warranties on its products, including warranties of merchantability and fitness for the particular purpose, shall apply as provided under applicable law.

Other Conditions

Atlona's Limited Product Warranty offering gives legal rights, and other rights may apply and vary from country to country or state to state. This limited warranty is void if (i) the label bearing the serial number of products have been removed or defaced, (ii) products are not purchased from an authorized Atlona dealer or reseller. A comprehensive list of Atlona's authorized distributors, dealers and resellers can be found at www.atlona.com.

Atlona, Inc Product Registration

Thank you for purchasing this Atlona product. - We hope you enjoy it and will take an extra few moments to register your new purchase.

Registration creates an ownership record if your product is lost or stolen and helps ensure you'll receive notification of performance issues and firmware updates.

At Atlona we respect and protect your privacy, assuring you that your registration information is completely secure. Atlona product registration is completely voluntary and failure to register will not diminish your limited warranty rights.

To register go to: <http://www.atlona.com/registration>