



KRAMER ELECTRONICS LTD.

USER MANUAL

MODEL:

VS-62HA
6x2 HDMI/Audio Matrix
Switcher

P/N: 2900-300469 Rev 1



VS-62HA Quick Start Guide

This guide helps you install and use your product for the first time. For more detailed information, go to <http://www.kramerav.com/manual/VS-62HA> to download the latest manual or scan the QR code on the left.

Step 1: Check what's in the box

- VS-62HA** 6x2 HDMI/Audio Matrix Switcher
- 1 Power cord
- 4 Rubber feet

- 1 Quick Start sheet
- Kramer **RC-IR3** Infrared Remote Control Transmitter with batteries and user manual

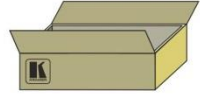

Step 2: Install the VS-62HA

Mount the **VS-62HA** in a rack (using the included rack "ears") or attach the rubber feet and place on a table.

Step 3: Connect the inputs and outputs

Always switch off the power on each device before connecting it to your **VS-62HA**.

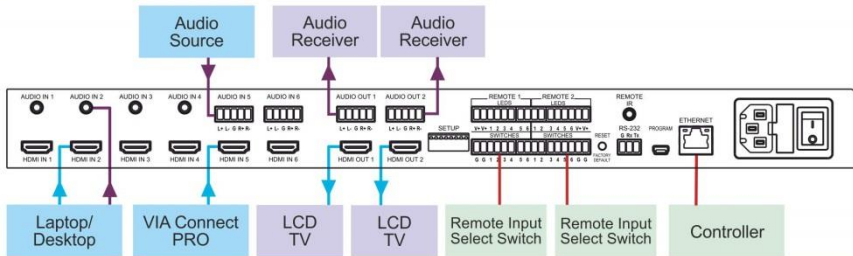

Always use Kramer high-performance cables for connecting AV equipment to the **VS-62HA**.

Step 4: Connect the power

Connect the power cord to the **VS-62HA** and plug it into the mains electricity.



Step 5: Operate the VS-62HA

Switch an Input to an Output:

- Press an input button on the top row (To OUT1) to switch that input to output 1
- Press an input button on the bottom row (To OUT2) to switch that input to output 2

Switch to analog audio:

- Press the ANALOG button for the given output to use the analog audio from the selected input

Copy an EDID from an Output to an Input:

1. Press the EDID button
2. Press the required Input button corresponding to either Output 1 or Output 2.
3. Press the EDID button

Change audio volume:

- Press VOL+/- to increase/decrease volume
- Press MUTE to turn audio off and on
- Press SWAP to switch audio between outputs

Contents

1	Introduction	1
2	Getting Started	2
2.1	Achieving the Best Performance	2
2.2	Safety Instructions	3
2.3	Recycling Kramer Products	3
3	Overview	4
3.1	Using the IR Transmitter	5
3.2	Defining the VS-62HA 6x2 HDMI/Audio Matrix Switcher	5
4	Installing in a Rack	9
5	Connecting the VS-62HA	10
5.1	Connecting a Serial Controller to the VS-62HA via RS-232	11
5.2	Connecting to the VS-62HA via Ethernet	11
5.3	Connecting the Remote Contact-Closure Switches and LEDs	15
6	Principles of Operation	17
6.1	Automatic Signal Detection	17
6.2	Input Switching Modes	17
6.3	EDID Operation	18
6.4	Step-in Functionality	18
7	Operating the VS-62HA 6x2 HDMI/Audio Matrix Switcher	19
7.1	Switching an Input to an Output	19
7.2	Switching Analog Audio	19
7.3	Acquiring an EDID from an Output	20
7.4	Locking and Unlocking the Front Panel Buttons	21
7.5	Generating a Test Pattern	22
8	Configuring and Maintaining the VS-62HA	23
8.1	Setting the DIP-Switches	23
8.2	Resetting the VS-62HA to Factory Default Settings	24
8.3	Upgrading the Firmware	24
9	Operating the VS-62HA Remotely via the Web Pages	25
9.1	Browsing the VS-62HA Web Pages	25
9.2	Video Switching Page	26
9.3	Analog Audio Switching	29
9.4	EDID Management	30
9.5	Device Setting Page	33
9.6	Firmware Upgrade Page	34
9.7	About Us Page	35
10	Wiring the Twisted Pair RJ-45 Connectors	36
11	Technical Specifications	37
12	Default Communication Parameters	38
13	Default EDID	39
14	Protocol 3000 Syntax	41
14.1	Host Message Format	41
14.2	Device Message Format	41
14.3	Command Terms	42
14.4	Entering Commands	43
14.5	Bidirectional Definition	43

14.6	Command Chaining	43
14.7	Maximum String Length	44
15	Protocol 3000 Commands	45
15.1	System Commands - Mandatory	46
15.2	System Commands	51
15.3	Switching/Routing Commands	59
15.4	Video Commands	62
15.5	Audio Commands	64
15.6	Communication Commands	66
15.7	EDID Handling Commands	70
15.8	Step-in Commands	73
16	Messages and Codes	74
16.1	Device Initiated Messages	74
16.2	Result and Error Codes	74
17	Packet Protocol Structure	76
17.1	Using the Packet Protocol	76
17.2	Calculating the CRC	77
18	Parameters	76
18.1	On/Off	76
18.2	Stage	76
18.3	Signal Type	76
18.4	Genlock Types	76
18.5	Video Port Type	77
18.6	Video Resolutions	77
18.7	Color Space	79
18.8	Image Properties	79
18.9	View Modes	79
18.10	Custom Resolution Parameters	80
18.11	Detail Timing Parameters	80
18.12	Video/Audio Signal Changes	80
18.13	Font Size	81
18.14	Layer Enumeration	81
18.15	Software Programmed	81
18.16	EDID Source	81
18.17	EDID Audio Capabilities	81
18.18	Signal Validation	82
18.19	Ethernet Port Types	82
18.20	HDCP Types	82
18.21	Parity Types	82
18.22	Serial Types	82
18.23	Audio Signal Types	83
18.24	Frequency Number	83
18.25	Audio Level	83
18.26	Audio Delay	84
18.27	IR Transmit Status	84

Figures

Figure 1: VS-62HA 6x2 HDMI/Audio Matrix Switcher Front Panel	6
Figure 2: VS-62HA 6x2 HDMI/Audio Matrix Switcher Rear Panel	8
Figure 3: Connecting the VS-62HA 6x2 HDMI/Audio Matrix Switcher	10
Figure 4: Local Area Connection Properties Window	13
Figure 5: Internet Protocol Version 4 Properties Window	14
Figure 6: Internet Protocol Properties Window	15
Figure 7: Remote Contact-closure Switch and LED Connections	16
Figure 8: Test Patterns	22
Figure 9: Video Switching Page	26
Figure 10: The Remote Device Control Window	27
Figure 11: Test Pattern Tab	28
Figure 12: EDID Page	31
Figure 13: The Device Setting Page	33
Figure 14: The Firmware Upgrade Page	34
Figure 15: About Page	35
Figure 16: TP Pinout Wiring	36

1 Introduction

Welcome to Kramer Electronics! Since 1981, Kramer Electronics has been providing a world of unique, creative, and affordable solutions to the vast range of problems that confront video, audio, presentation, and broadcasting professionals on a daily basis. In recent years, we have redesigned and upgraded most of our line, making the best even better!

Our 1,000-plus different models now appear in 14 groups that are clearly defined by function: GROUP 1: Distribution Amplifiers; GROUP 2: Switchers and Routers; GROUP 3: Control Systems; GROUP 4: Format/Standards Converters; GROUP 5: Range Extenders and Repeaters; GROUP 6: Specialty AV Products; GROUP 7: Scan Converters and Scalers; GROUP 8: Cables and Connectors; GROUP 9: Room Connectivity; GROUP 10: Accessories and Rack Adapters; GROUP 11: Sierra Video Products; GROUP 12: Digital Signage; GROUP 13: Audio; and GROUP 14: Collaboration.

Congratulations on purchasing your Kramer **VS-62HA** 6x2 *HDMI/Audio Matrix Switcher*, which is ideal for the following typical applications:

- Conference rooms
- Entertainment
- Hospitality

2 Getting Started

We recommend that you:

- Unpack the equipment carefully and save the original box and packaging materials for possible future shipment
- Review the contents of this user manual



Go to <http://www.kramerav.com/downloads/VS-62HA> to check for up-to-date user manuals, application programs, and to check if firmware upgrades are available (where appropriate).

2.1 Achieving the Best Performance

To achieve the best performance:

- Use only good quality connection cables (we recommend Kramer high-performance, high-resolution cables) to avoid interference, deterioration in signal quality due to poor matching, and elevated noise levels (often associated with low quality cables)
- Do not secure the cables in tight bundles or roll the slack into tight coils
- Avoid interference from neighboring electrical appliances that may adversely influence signal quality
- Position your Kramer **VS-62HA** away from moisture, excessive sunlight and dust



This equipment is to be used only inside a building. It may only be connected to other equipment that is installed inside a building.

2.2 Safety Instructions



Caution: There are no operator serviceable parts inside the unit

Warning: Use only the power cord that is supplied with the unit

Warning: Do not open the unit. High voltages can cause electrical shock! Servicing by qualified personnel only

Warning: Disconnect the power and unplug the unit from the wall before installing

2.3 Recycling Kramer Products

The Waste Electrical and Electronic Equipment (WEEE) Directive 2002/96/EC aims to reduce the amount of WEEE sent for disposal to landfill or incineration by requiring it to be collected and recycled. To comply with the WEEE Directive, Kramer Electronics has made arrangements with the European Advanced Recycling Network (EARN) and will cover any costs of treatment, recycling and recovery of waste Kramer Electronics branded equipment on arrival at the EARN facility. For details of Kramer's recycling arrangements in your particular country go to our recycling pages at <http://www.kramerelectronics.com/support/recycling/>.

3 Overview

The **VS-62HA** is a 4K UHD 6x2 matrix switcher for HDMI and analog audio signals. It reclocks and equalizes the signals and can route any input to either or both outputs simultaneously. It supports resolutions of up to 4K UHD including 4K@60Hz (4:2:0).

In particular, the **VS-62HA** features:

- Up to 8.91Gbps data rate (2.97Gbps per graphics channel)
- Maximum resolution of up to 4K@60Hz UHD (4:2:0).
- Support for HDCP (High Definition Digital Content Protection)
- HDMI Support – 3D, Deep Color, x.v.Color™, Lip Sync, ARC, Dolby® TrueHD, Dolby Digital Plus, DTS-HD®, and 7.1 multi-channel audio
- Four unbalanced and two balanced audio inputs and two balanced audio outputs on a matrix switcher
- Contact closures to mirror front panel switching selection buttons and LEDs
- Per input EDID capture that copies and stores the EDID from a display device
- Independent (breakaway) audio routing of HDMI and analog audio content to two balanced audio ports
- Programmable step-in functionality when used in conjunction with compatible step-in devices, such as the **SID-X3N** and **DIP-30** (using an HDMI cable that supports HEC, the HDMI Ethernet Channel)
- True video clock detection
- Advanced auto AV switching modes (last connected and priority switching)
- Non-volatile EDID storage
- Kramer reClocking™ & Equalization Technology that rebuilds the digital signal to travel longer distances
- A lock button to prevent unwanted tampering with the buttons on the front panel
- Internal pattern generator

- Support for Kramer Protocol 3000
- Static or dynamic DHCP IP addressing
- Flexible control options including front panel buttons, IR remote (included), optional external remote IR receiver, RS-232, Ethernet, buttons and LED over contact closure, embedded Web server and step-in.
- Mini-USB port for upgrading firmware
- 19" 1U enclosure for rack mounting

3.1 Using the IR Transmitter

You can use the **RC-IR3** IR transmitter to control the machine via an optional external IR receiver (for example, P/N C-A35M/IRR-50). The external IR receiver can be located up to 15m away from the machine. This distance can be extended to up to 60m when used with three extension cables (for example, P/N C-A35M/A35F-50).

Before using the external IR receiver, be sure to arrange for your Kramer dealer to insert the internal IR connection cable (for example, P/N: 505-70434010-S) with the 3.5mm connector that fits into the REMOTE IR opening on the rear panel. Connect the external IR receiver to the REMOTE IR 3.5mm connector.

3.2 Defining the VS-62HA 6x2 HDMI/Audio Matrix Switcher

This section defines the **VS-62HA**.

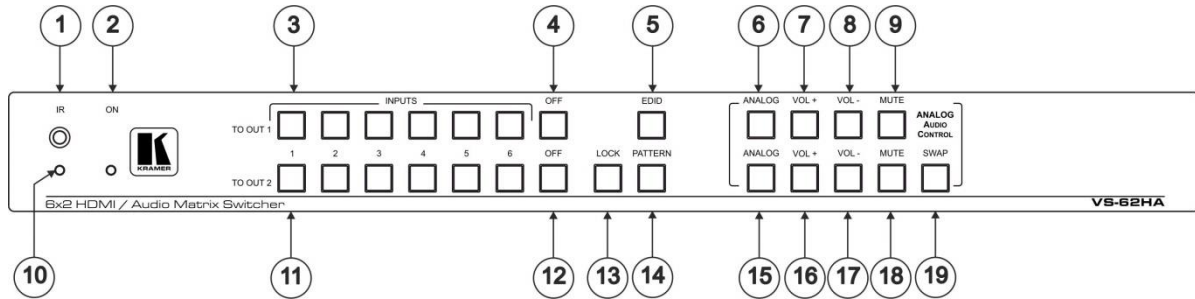

Figure 1: VS-62HA 6x2 HDMI/Audio Matrix Switcher Front Panel

#	Feature	Function	
1	IR Sensor	Signal receiver for the infrared remote control transmitter	
2	ON LED	Lights green when the device is powered on	
3	INPUT Selector Buttons (1 to 6)	TO OUT 1 Press one of the six inputs to switch it to Output 1	
4	OFF Button		Press to turn off HDMI output 1
5	EDID Button		Press to capture the EDID (see Section 7.2)
6	ANALOG Button		Press to select/de-select the analog audio of output 1, colors are as follows: green – analog audio follows HDMI video input red – analog audio breakaway (Web control only) off – outputs HDMI audio of the selected HDMI input
7	VOL+ Button		Press to increase output 1 volume
8	VOL- Button		Press to decrease output 1 volume
9	MUTE Button		Press to toggle muting of output 1 audio
10	IR LED		Lights yellow when receiving an IR signal

#	Feature		Function
11	<i>INPUT</i> Selector Buttons (1 to 6)	TO OUT 2	Press one of the six inputs to switch it to Output 2
12	<i>OFF</i> Button		Press to turn off output 2
13	<i>LOCK</i> Button		Press to inactivate/activate all front panel buttons to prevent tampering
14	<i>PATTERN</i> Button		Press to activate the test pattern generator. When the generator is active, press one of the input buttons to select a test pattern
15	<i>ANALOG</i> Button		Press to select the analog audio of output 2
16	<i>VOL+</i> Button		Press to increase output 2 volume
17	<i>VOL-</i> Button		Press to decrease output 2 volume
18	<i>MUTE</i> Button		Press to toggle muting of output 2 audio
19	<i>SWAP</i> Button		Press to swap output 1 and output 2

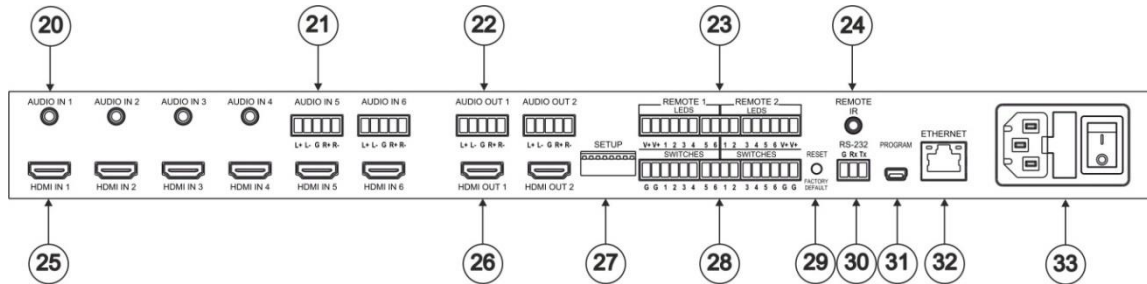

Figure 2: VS-62HA 6x2 HDMI/Audio Matrix Switcher Rear Panel

#	Feature	Function
20	AUDIO IN (1-4) 3.5mm Mini Jacks	Connect to unbalanced stereo audio sources (1-4)
21	AUDIO IN (5-6) 5-pin Terminal Blocks	Connect to balanced stereo audio sources (5-6)
22	AUDIO OUT (1-2) 5-pin Terminal Blocks	Connect to balanced stereo audio acceptors (1-2)
23	REMOTE LEDS (1-2) Terminal Blocks	Connect to LEDS that display the selected input channel (1-6)
24	REMOTE IR 3.5mm Mini Jack	Connect to an external IR receiver for controlling the device via an IR remote controller (see Section 3.1). Covered by a cap. The 3.5mm mini jack at the end of the internal IR connection cable fits into this opening
25	HDMI IN (1-6) Connectors	Connect to HDMI sources (1-6)
26	HDMI OUT (1-2) Connectors	Connect to HDMI acceptors (1-2)
27	SETUP DIP-Switches	Sets the device configuration (see Section 8.1)
28	REMOTE SWITCHES (1-2)	Connect to up to six remote, contact-closure input selection switches for Output 1 and Output 2 (see Section 5.3)
29	RESET/FACTORY DEFAULT Button	Press while power-cycling the device to reset to factory default parameters (see Section 12)
30	RS-232 3-pin Terminal Block	Connect to a PC/serial controller (see Section 5.1)
31	PROGRAM USB Connector	Connect to a PC to upgrade the firmware (see Section 8.3)
32	ETHERNET RJ-45 Connector	Connect to a PC via a LAN (see Section 5.2)
33	Power Module (Socket, Fuse, On/Off Switch)	Connects to mains power and turns the unit on and off

4 Installing in a Rack

This section provides instructions for rack mounting the unit.

Before installing in a rack, be sure that the environment is within the recommended range:

OPERATING TEMPERATURE:	0° to +40°C (32° to 104°F)
STORAGE TEMPERATURE:	-40° to +70°C (-40° to 158°F)
HUMIDITY:	10% to 90%, RHL non-condensing



CAUTION!

When installing on a 19" rack, avoid hazards by taking care that:

1. It is located within the recommended environmental conditions, as the operating ambient temperature of a closed or multi unit rack assembly may exceed the room ambient temperature.
2. Once rack mounted, enough air will still flow around the machine.
3. The machine is placed straight in the correct horizontal position.
4. You do not overload the circuit(s). When connecting the machine to the supply circuit, overloading the circuits might have a detrimental effect on overcurrent protection and supply wiring. Refer to the appropriate nameplate ratings for information. For example, for fuse replacement, see the value printed on the product label.
5. The machine is earthed (grounded) in a reliable way and is connected only to an electricity socket with grounding. Pay particular attention to situations where electricity is supplied indirectly (when the power cord is not plugged directly into the socket in the wall), for example, when using an extension cable or a power strip, and that you use only the power cord that is supplied with the machine.

To rack-mount a machine:

1. Attach both ear brackets to the machine. To do so, remove the screws from each side of the machine (3 on each side), and replace those screws through the ear brackets.

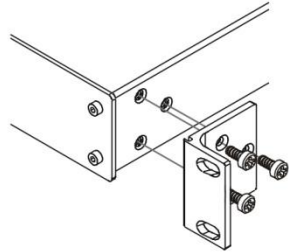

2. Place the ears of the machine against the rack rails, and insert the proper screws (not provided) through each of the four holes in the rack ears.

Note:

- In some models, the front panel may feature built-in rack ears
- Detachable rack ears can be removed for desktop use
- Always mount the machine in the rack before you attach any cables or connect the machine to the power
- If you are using a Kramer rack adapter kit (for a machine that is not 19"), see the Rack Adapters user manual for installation instructions available from our Web site

5 Connecting the VS-62HA



Always switch off the power to each device before connecting it to your **VS-62HA**. After connecting your **VS-62HA**, connect its power and then switch on the power to each device.

To connect the **VS-62HA** as illustrated in the example in [Figure 3](#):

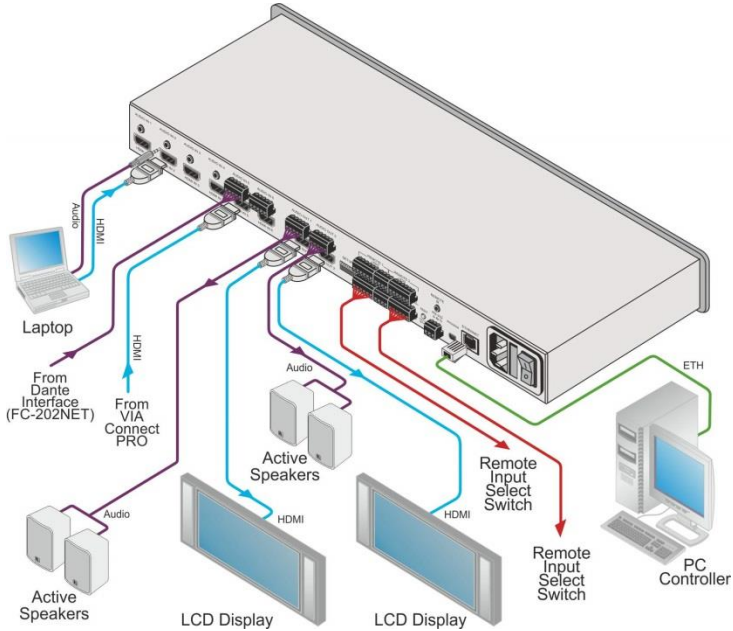

Figure 3: Connecting the VS-62HA 6x2 HDMI/Audio Matrix Switcher

1. Connect up to six HDMI sources, (for example, a laptop, desktop, VIA Connect PRO) to the HDMI In connectors.
2. Connect up to six analog audio sources, (for example, a laptop, desktop, a Dante interface) to the AUDIO IN connectors. AUDIO IN 1 through 4 are unbalanced stereo on 3.5mm mini jacks. AUDIO IN 5 and 6 are balanced stereo audio on 5-pin terminal block connectors.

3. Connect the two HDMI OUT connectors to up to two HDMI acceptors, (for example, LCD displays).
4. Connect the two balanced AUDIO OUT 5-pin terminal block connectors to up to two analog audio acceptors, (for example, audio receivers).
5. If required, connect a PC/controller to the RS-232 port (see [Section 5.1](#)) and/or the Ethernet port (see [Section 5.2](#)).
6. If required for remote switching, connect up to 6 contact closure switches per channel to their terminal block connectors (Remote 1 and 2 Switches).
7. If required for remote switch indication, connect up to 6 LEDs per channel to their terminal block connectors (Remote 1 and 2 LEDs).
8. Connect a power cord to the device and plug it into the mains electricity (not shown in [Figure 3](#)).
9. If required, acquire the EDID (see [Section 7.1](#)).

5.1 Connecting a Serial Controller to the VS-62HA via RS-232

To connect a serial controller to the VS-62HA:

- From the RS-232 9-pin D-sub serial port on the serial controller connect:
 - Pin 2 to the TX pin on the **VS-62HA** RS-232 terminal block
 - Pin 3 to the RX pin on the **VS-62HA** RS-232 terminal block
 - Pin 5 to the GND pin on the **VS-62HA** RS-232 terminal block

5.2 Connecting to the VS-62HA via Ethernet

You can connect to the **VS-62HA** via Ethernet using either of the following methods:

- Directly to the PC using a crossover cable (see [Section 5.2.1](#))
- Via a network hub, switch, or router, using a straight-through cable (see [Section 5.2.2](#))

Note: If you want to connect via a router and your IT system is based on IPv6, speak to your IT department for specific installation instructions.

5.2.1 Connecting the Ethernet Port Directly to a PC

You can connect the Ethernet port of the **VS-62HA** directly to the Ethernet port on your PC using a crossover cable with RJ-45 connectors.



This type of connection is recommended for identifying the **VS-62HA** with the factory configured default IP address.

After connecting the VS-62HA to the Ethernet port, configure your PC as follows:

1. Click **Start > Control Panel > Network and Sharing Center**.
2. Click **Change Adapter Settings**.
3. Highlight the network adapter you want to use to connect to the device and click **Change settings of this connection**.

The Local Area Connection Properties window for the selected network adapter appears as shown in [Figure 4](#).

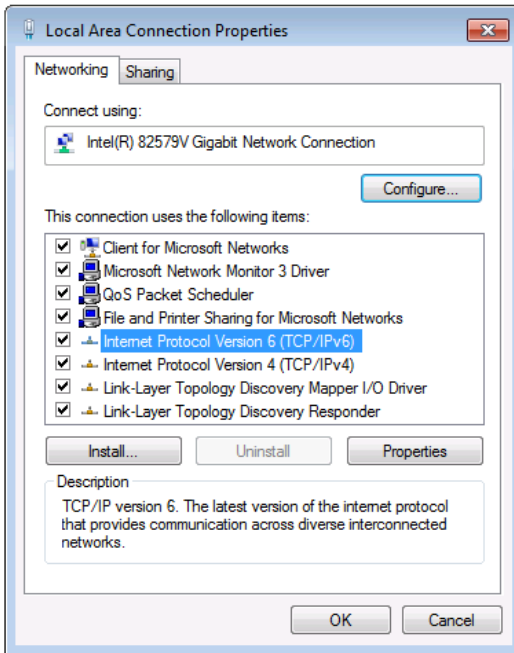

Figure 4: Local Area Connection Properties Window

4. Highlight **Internet Protocol Version 4 (TCP/IPv4)** by clicking on the item.
5. Click **Properties**.

The Internet Protocol Properties window appears as shown in [Figure 5](#).

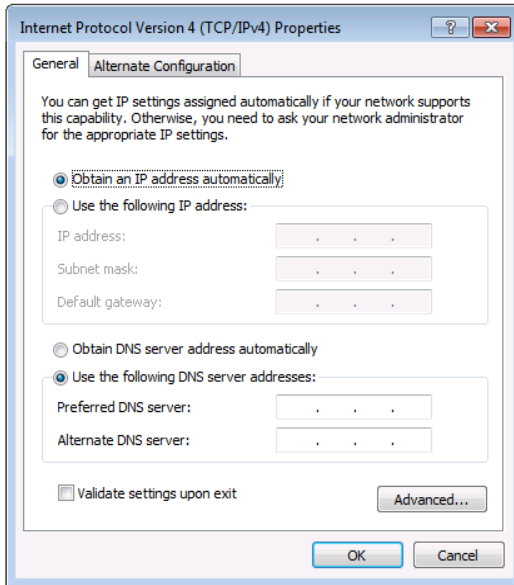

Figure 5: Internet Protocol Version 4 Properties Window

6. Select **Use the following IP Address** for static IP addressing and fill in the details as shown in [Figure 6](#).
For TCP/IPv4 you can use any IP address in the range 192.168.1.1 to 192.168.1.255 (excluding 192.168.1.39) that is provided by your IT department.

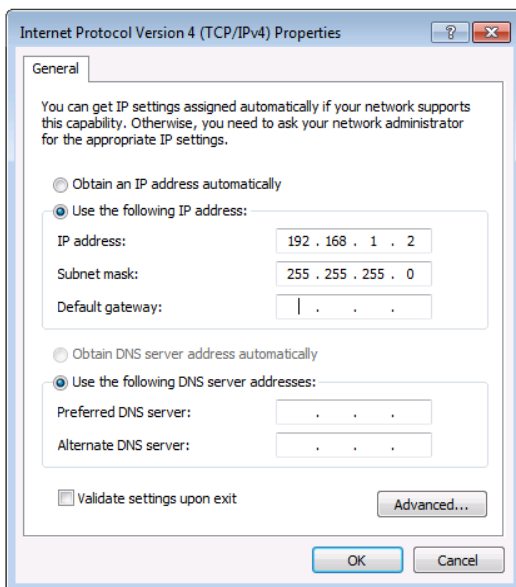

Figure 6: Internet Protocol Properties Window

7. Click **OK**.
8. Click **Close**.

5.2.2 Connecting the Ethernet Port via a Network Hub or Switch

You can connect the Ethernet port of the **VS-62HA** to the Ethernet port on a network hub or using a straight-through cable with RJ-45 connectors.

5.3 Connecting the Remote Contact-Closure Switches and LEDs

You can connect up to six remote, contact-closure switches and LEDs per output to control the **VS-62HA** remotely. These switches replicate the Input selection buttons on the front panel of the **VS-62HA**.

Figure 7 illustrates the wiring of the switch connections to the terminal block.

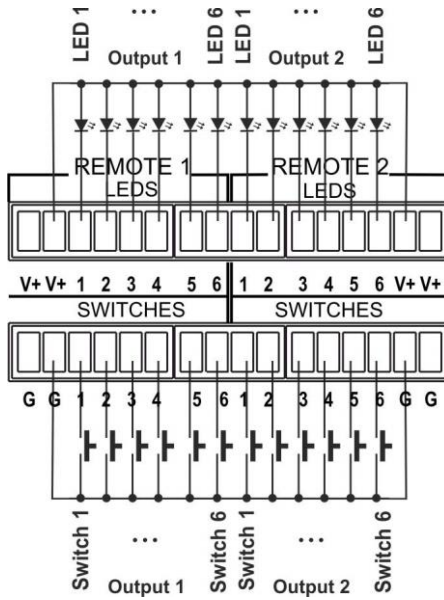

Figure 7: Remote Contact-closure Switch and LED Connections

6 Principles of Operation

This section describes the operating theory of the **VS-62HA** and includes:

- Automatic signal detection (see [Section 6.1](#))
- Input switching modes (see [Section 6.2](#))
- EDID operation (see [Section 6.3](#))

6.1 Automatic Signal Detection

The **VS-62HA** can automatically detect the presence of a video signal on an input based on the presence of a video sync or clock signal.

6.2 Input Switching Modes

6.2.1 Manual Mode

In Manual switching mode, routing is performed according to the front panel button selection or according to the remote command selection.

6.2.2 Automatic Mode

Automatic switching can be performed in either of the following ways:

- **Input priority.** Upon detection of an active input, the input with the highest priority is automatically selected. Input priority is from the lowest input number (1) to the highest (6)
- **Last Connected.** The device automatically selects the most recently connected input. Should this source become inactive, the device automatically switches to the last connected input that was active. When turning the device on and more than one input is active, the input with the highest priority is selected

If a manual selection is made when the device is in Automatic mode, the device enters Manual Override mode. The manually selected input remains selected as long as it is active. When a manually selected input becomes inactive, the device returns to Automatic mode.

6.3 EDID Operation

The **VS-62HA** has a default EDID (see [Section 13](#)) stored on all inputs. This EDID can be exchanged for either:

- A custom EDID which is uploaded to one or more inputs using Protocol 3000 commands (see [Section 15](#))
–OR–
- The EDID of a display device connected to an output by using either the front panel buttons (see [Section 7.2](#)), a Protocol 3000 command, or the Web pages

The EDID is non-volatile and the last valid EDID is used when the device is powered up.

6.4 Step-in Functionality

The **VS-62HA** can function as a step-in switcher when connected to a suitable HDMI transmitter, (for example, the **SID-X3N**), using the correct HDMI cable with HEC support.

Use the Web pages (see [Section 9.2.2](#)) to assign remote device button actions. The default button actions are shown in the following table. Up to three buttons can be active at the same time.

Command	Action
Echo	Allows a connected controller to be programmed to perform a variety of tasks triggered by the user buttons, such as, room control, (lights, screen, and so on)
Out1	Step in current input to Output 1
Out2	Step in current input to Output 2

7 Operating the VS-62HA 6x2 HDMI/Audio Matrix Switcher

This section describes operating the **VS-62HA** and consists of:

- Switching an input to an output (see [Section 7.1](#))
- Switching Analog Audio (see [Section 7.2](#))
- Acquiring an EDID from an output (see [Section 7.3](#))
- Locking and unlocking the front panel buttons (see [Section 7.4](#))
- Generating a test pattern (see [Section 7.5](#))

7.1 Switching an Input to an Output

To switch an input to an output, (for example, Input 5 to Output 2):

- Press the Input 5 button in the bottom Output (To OUT 2) row.
The LED lights red and Input 5 is switched to Output 2
After cycling power, auto-switching is only predictable after the first active switching.

7.2 Switching Analog Audio

This section describes analog audio switching by means of the front panel buttons. The front panel buttons only control AFV analog switching. Breakaway analog switching is only available over Web control. For a description of analog audio switching over the Web, see [Section 9.3](#).

To output an analog audio source associated with a given HDMI input:

- Press the ANALOG button for the desired output
The ANALOG button lights green and the analog audio for the selected HDMI input is routed to the output instead of the embedded HDMI audio

To change the volume of the selected audio input (HDMI or analog):

- Press VOL+ to increase and VOL- to decrease the output volume

To mute the output volume:

- Press the MUTE button for the desired output
The button lights and the volume is turned off
- Press the MUTE button again for the desired output
The button goes off and the volume is turned on

To exchange audio outputs:

- Press SWAP
Audio OUT 1 routes to OUT 2 and audio OUT 2 routes to OUT 1
- To return the audio outputs to their normal place, press SWAP again to unswap the audio outputs

7.3 Acquiring an EDID from an Output

You can acquire the EDID from OUT 1 or OUT 2 and copy it to any or all of the six inputs to be stored in non-volatile memory. You can also reset any or all of the inputs to the default EDID.

To copy the EDID from an Output to one or more Inputs:

1. Press the EDID button to enter the EDID setting mode.
The EDID button lights.

Note: If there is no button activity for 10 seconds, the device automatically exits the EDID setting mode to normal operation, the EDID button no longer lights and any changes made are lost.

2. From the To OUT 1 (top) row, press each of the Inputs to which you want to copy the EDID from Output 1.
Each selected Input LED lights.
3. From the To OUT 2 (bottom) row, press each of the Inputs into which you want to copy the EDID from Output 2.
Each selected Input LED lights.

Note: If the **VS-62HA** reads a corrupted EDID from the sink connected to output 1 or 2, it writes the default EDID to the input.

4. Press the EDID button.
The button no longer lights and the EDID changes are saved.

To copy the default EDID to one or more Inputs:

1. Press the EDID button to enter the EDID setting mode.
The EDID button lights.
2. For each Input to which you want to copy the default EDID, press both the To OUT 1 and To OUT 2 buttons simultaneously.
Both top row and bottom row Input LEDs light.
3. Press the EDID button.
The button no longer lights and the EDID changes are saved.

7.4 Locking and Unlocking the Front Panel Buttons

To lock and unlock the front panel buttons:

1. Press and hold the Lock button.
The front panel buttons are locked and the button lights.
2. Press and hold the Lock button again.
The front panel buttons are unlocked and the button no longer lights.

7.5 Generating a Test Pattern

For diagnostic purposes, the **VS-62HA** can generate a number of test patterns on the outputs.

To generate a test pattern on the outputs:

1. Press the Pattern button.
The button lights.
2. Press any of the Input buttons to select a test pattern.
The selected test pattern is generated on the outputs.

To exit the test pattern generator:

- Press the lit Pattern button.
The test pattern generation ceases and the button no longer lights.

[Figure 8](#) shows the test patterns available.

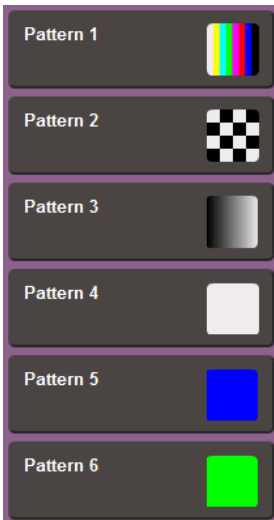

Figure 8: Test Patterns

8 Configuring and Maintaining the VS-62HA

This section describes the configuration and maintenance of the **VS-62HA** and consists of:

- Setting the DIP-switches (see [Section 8.1](#))
- Resetting the device to factory default settings (see [Section 8.2](#))
- Upgrading the firmware (see [Section 8.3](#))

8.1 Setting the DIP-Switches

The Setup DIP-switches dictate the behavior of the **VS-62HA**.

All DIP-switches are off by default.

#	Feature	Description
1	HDCP support on inputs	On—Disable HDCP support on all inputs Off—Enable HDCP support which is defined by P3000 commands
2	Video mode switching Output 1	On—Auto Off—Manual
3	Last connected/Priority mode Output 1	When DIP-switch 2 is set to Auto (ON): On—Enable Last Connected mode Off—Enable Priority mode where the priority of each input is defined by the input number, (1 is the highest priority)
4	Video mode switching Output 2	On—Auto Off—Manual
5	Last connected/Priority mode Output 2	When DIP-switch 4 is set to Auto (ON): On—Enable Last connected mode Off—Enable Priority mode where the priority of each input is defined by the input number, (1 is the highest priority)
6	N/A	N/A
7	N/A	N/A
8	N/A	N/A

8.2 Resetting the VS-62HA to Factory Default Settings

To reset the device to factory default settings:

1. Power off the device.
2. Press and hold down the Reset button on the rear panel.
3. While holding down the Reset button, power on the device.
4. Wait a few seconds and release the button.
The device is reset to its factory settings.

8.3 Upgrading the Firmware

The **VS-62HA** can be upgraded via any of the following:

- Mini USB
- RS-232
- Ethernet

For instructions on upgrading the firmware see “*K-Upload Software*”.

9 Operating the VS-62HA Remotely via the Web Pages

The **VS-62HA** can be operated remotely using the embedded Web pages. The Web pages are accessed using a Web browser and an Ethernet connection.

Before attempting to connect:

- Perform the procedures in [Section 5.2](#)
- Ensure that JavaScript is enabled

9.1 Browsing the VS-62HA Web Pages

Note: In the event that a Web page does not update correctly, clear your Web browser's cache (by pressing CTRL-F5).

To browse the VS-62HA Web pages:

1. Open your Internet browser.
2. Type the IP number of the device (see [Section 5.2](#)) in the Address bar of your browser.



There are six Web pages:

- Video Switching (see [Section 9.2](#))
- Analog Audio Switching (see [Section 9.3](#))
- EDID Management (see [Section 9.4](#))
- Device Settings (see [Section 9.5](#))
- Firmware Upgrade (see [Section 9.6](#))
- About (see [Section 9.7](#))

9.2 Video Switching Page

The **VS-62HA** video switching page lets you perform operational actions, such as, switching inputs/outputs and selecting HDCP support.

The following illustration explains the elements of the video switching page.

Note: Most elements have tool tips that appear when the element is touched.

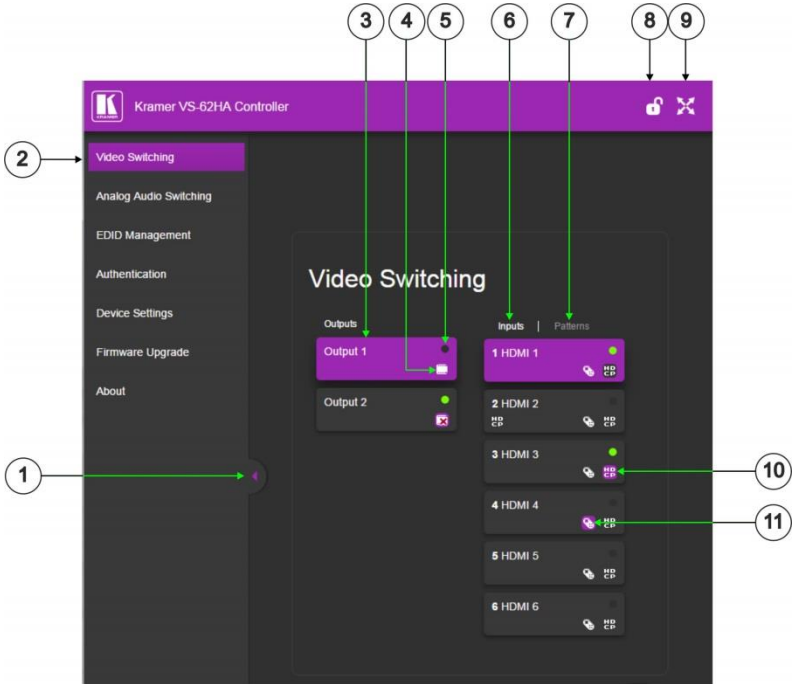

Figure 9: Video Switching Page

#	Item	Description
1	Show/Hide Panel	Click to show or hide the Web page panel
2	Web Page Selector	Click to show the desired Web page
3	Output Buttons 1 and 2	2 buttons to select the output (highlighted when selected)
4	Mute/Unmute Video	Click to turn off/on
5	Connection Indicator	Lights green when connected, grey when off
6	Inputs Tab	Click to display the 6 input buttons for input selection, and port and signal identification (see Section 9.2.1)
7	Patterns Button Tab	Click to display 6 test patterns (see Section 9.2.3)

#	Item	Description
8	Security Icon	Open lock indicates security not active, closed lock indicates active security (set security on the Authentication tab)
9	Full Screen Icon	Click to toggle full screen on/off
10	HDCP Icon	Click to toggle HDCP on/off (highlighted when active)
11	Remote Device Icon	Click to setup remote device (see Section 9.2.2) (highlighted when active)

9.2.1 Switching an Input to an Output

To switch an Input to an Output, (for example, Input 2 to Output 2):

1. Click on Output button 2.
The button changes color to purple and the Output is selected.
2. Click on Input button 2.
The button changes color to purple and the output is switched.

9.2.2 Controlling a Remote Transmitter

Compatible remote transmitters, (for example, the **SID-X3N**) that are connected to the **VS-62HA** can be controlled using the Web pages.

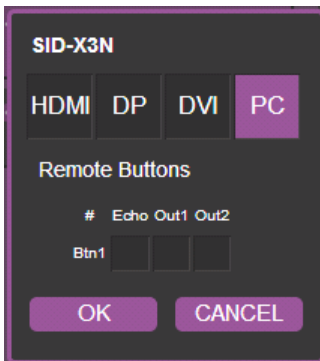

Figure 10: The Remote Device Control Window

The **VS-62HA** allows you to program the general purpose buttons on remote modules. The table shows the functionality defined for each button. The options are:

- HDMI, DP, DVI, PC—selects one of the inputs

- Echo—allows a connected controller to be programmed to perform a variety of tasks triggered by the user buttons, such as, room control, (lights, screen, and so on)
- Out 1—step-in current input to output 1
- Out 2—step-in current input to output 2

Note: These settings are per input and remain valid even if the remote **SID-X3N** is exchanged for another **SID-X3N**.

Up to three of the Echo, Out 1 and Out 2 buttons can be active at the same time.

9.2.3 Using Test Patterns as Video Inputs

You can use one of six built-in, video test patterns as a video Input.

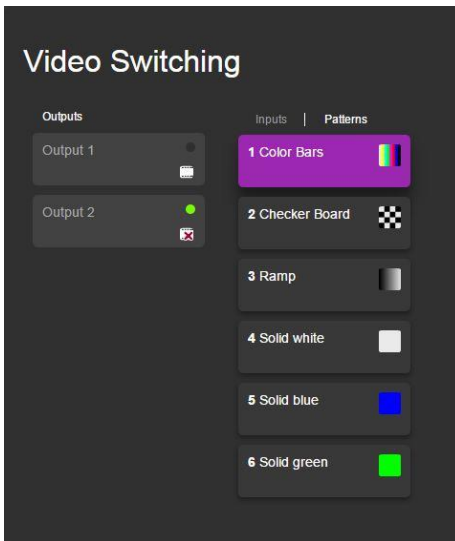

Figure 11: Test Pattern Tab

To select a test pattern as an Input for an Output:

1. Click the Patterns tab.
The six test pattern buttons are shown.

2. Click the required Output to select it.
The button changes color.
3. Click the required test pattern button.
The button changes color and the selected test pattern is switched to the Output.

9.3 Analog Audio Switching

The Analog Audio Switching page allows you to switch analog audio inputs to the outputs.

The following illustration explains the elements of the analog audio switching page. **Note:** Most elements have tool tips that appear when the element is touched.

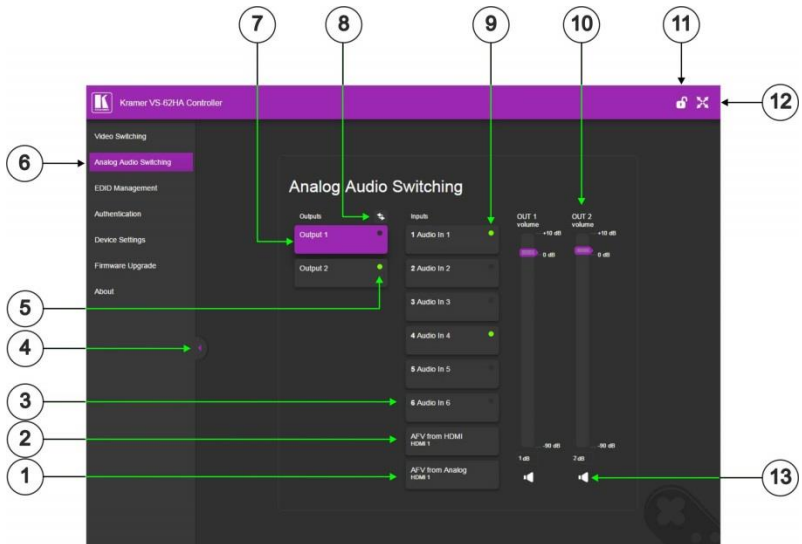

#	Item	Description
1	AFV from Analog	Click to output embedded audio from HDMI 1 or 2 inputs as selected by output 1 or 2
2	AFV from HDMI	Click to output analog audio from HDMI 1 or 2 inputs as selected by output 1 or 2
3	Input Buttons 1 to 6	Click to select analog audio input. Breakaway mode is enabled
4	Show/Hide Panel	Click to show or hide the Web page panel
5	Connection Indicator	Lights green when connected, grey when off

#	Item	Description
6	Web Page Selector	Click to show the desired Web page
7	Output Buttons 1 and 2	2 buttons to select the output (highlighted when selected)
8	Swap Audio Outputs	Click to swap Out 1 to Out 2 and Out 2 to Out 1, click again to unswap. When swap is active, the button lights
9	Selection Indicator	Lights green when selected
10	OUT Volume Slider 1 and 2	Click and drag the purple slider to the desired volume level. Click above or below the slider to increase or decrease the setting by 10dB. The set level shows at the bottom of the slider
11	Security Icon	Open lock indicates security not active, closed lock indicates active security (set security on the Authentication tab)
12	Full Screen Icon	Click to toggle full screen on/off
13	Mute/Unmute Output	Click to turn off/on

9.4 EDID Management

The **VS-62HA** EDID page lets you copy EDID data to one or more Inputs from an:

- Output
- Input
- Default EDID
- EDID data file

The following illustration explains the elements of the video switching page.

Note: Most elements have tool tips that appear when the element is touched.

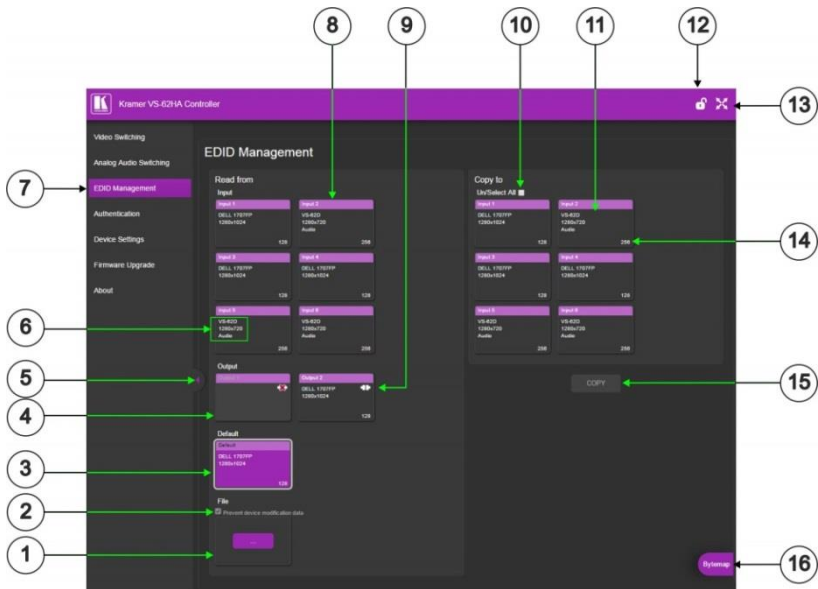

Figure 12: EDID Page

#	Item	Description
1	File Selector (...)	Click to browse saved EDID files on the computer
2	Prevent Modification Checkbox	Click to prevent modification of data
3	Default EDID Button	Click to read the default EDID
4	Output Buttons 1 and 2	2 buttons to select the output (highlighted when selected)
5	Show/Hide Panel	Click to show or hide the Web page panel
6	EDID Source Information	Device model, resolution, if audio connected
7	Web Page Selector	Click to show the desired Web page
8	Input Buttons (1-6)	Click to display the 6 input buttons for input selection, and port and signal identification (see Section 9.2.1)
9	Output Connection Status	Shows whether output is connected or not
10	Un/Select All Checkbox	Check to select or unselect copying EDID to all inputs
11	Copy To Section	From this section select the required EDID destination to copy to
12	Security Icon	Open lock indicates security not active, closed lock indicates active security (set security on the Authentication tab)
13	Full Screen Icon	Click to toggle full screen on/off
14	Audio Bitrate	Indicates the audio bitrate on the input or output
15	Copy Button	Click to copy the EDID from the selected source to the selected input
16	Bytemap Button	Click to open a window showing the selected EDID raw information

Note: The display is not updated automatically when the status of an EDID changes on the device due to outputs being exchanged. Click Refresh to update the display.

To copy EDID data from an Output or Input to one or more inputs:

1. Click the source button from which to copy the EDID (Output or Input).
The button changes color and the EDID summary information reflects the EDID data.
2. Click one or more destination Inputs, or select all Inputs by checking the Inputs check-box.
All selected Input buttons change color and the EDID summary information reflects the Input selection(s).
3. Click the Copy button.
The “EDID was copied” success message is displayed and the EDID data are copied to the selected Input(s).
4. Click OK.

To copy EDID data to an Input from an EDID data file:

1. Click the source Browse button.
The Windows Browser opens.
2. Browse to the required file.
3. Select the required file and click Open.
The EDID summary information reflects the selection.
4. Click one or more destination Inputs, or select all Inputs by checking the Inputs check-box.
All selected Input buttons change color and the EDID summary information reflects the Input selection(s).
5. Click the Copy button.
The “EDID was copied” success message is displayed and the EDID data are copied to the selected Input(s).

6. Click OK.

9.5 Device Setting Page

The **VS-62HA** Device Settings page lets you modify some communication parameters and view others.

Device Settings

Unit name

Model **VS-62HA**

Firmware version **R1.1.17317**

Serial number **12345678901**

Ethernet Settings

DHCP

IP address

Mask address

Gateway address

Mac address **00-1d-56-01-56-1b**

UDP port

All settings

Figure 13: The Device Setting Page

To modify serial or Ethernet communication parameters:

1. Adjust the parameters as required, either by entering the parameters directly or by using the drop-down list.
2. Click Set.
The changes are saved.

9.6 Firmware Upgrade Page

The Firmware Upgrade page lets you perform a firmware upgrade from a firmware file.

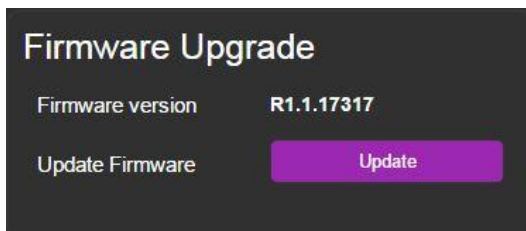

Figure 14: The Firmware Upgrade Page

To upgrade the firmware:

1. Click the Choose File button.
The Windows Browser opens.
2. Browse to the required file.
3. Select the required file and click Open.
The firmware file name is displayed in the Firmware Upgrade page.
4. Click Start Upgrade.
The firmware file is loaded and a progress bar is displayed.



Do not interrupt the process or the **VS-62HA** may be damaged.

5. When the process is complete reboot the device.
The firmware is upgraded.

9.7 About Us Page

The **VS-62HA** About Us page displays the Web page version and Kramer Electronics Ltd company details.



Figure 15: About Page

10 Wiring the Twisted Pair RJ-45 Connectors

Connect/solder the cable shield to the RJ-45 connector shield.



Do not use a crossed TP cable with this product.

Using a TP cable that is incorrectly wired may cause permanent damage to the device

Do not use unshielded TP cables with this product

[Figure 16](#) defines the TP pinout using a straight pin-to-pin cable with RJ-45 connectors.

EIA /TIA 568B	
PIN	Wire Color
1	Orange / White
2	Orange
3	Green / White
4	Blue
5	Blue / White
6	Green
7	Brown / White
8	Brown
Pair 1	4 and 5
Pair 2	1 and 2
Pair 3	3 and 6
Pair 4	7 and 8

Figure 16: TP Pinout Wiring

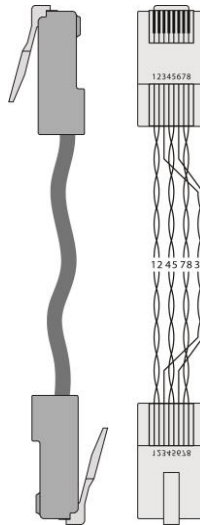

11 Technical Specifications

INPUTS:	6 HDMI connectors, 4 unbalanced stereo audio on 3.5mm mini jacks, 2 balanced stereo audio on 5-pin terminal blocks,
OUTPUTS:	2 HDMI connectors, 2 balanced stereo audio on 5-pin terminal blocks
PORTS:	1 RS-232 on a 3-pin terminal block, 1 Ethernet on an RJ-45 connector, 1 USB Type-C, 1 remote IR on a 3.5mm mini jack, 2 x 6 remote LED outputs on terminal blocks, 2 x 6 remote contact closure switches on terminal blocks
CONTROLS:	Front panel buttons, infrared remote control transmitter, RS-232, Ethernet, remote input selection switches and LEDs, built-in Web browser
LED INDICATORS:	IR active - red, ON - green
MAX. DATA RATE:	Up to 8.91Gbps data rate (2.97Gbps per graphic channel)
COMPLIANCE WITH HDMI STANDARD:	HDMI and HDCP
RESOLUTION:	Up to 4K@60Hz UHD (4:2:0)
SUPPORTED BAUD RATES:	9600, 115200bps
SUPPORTED WEB BROWSERS:	The following operating systems and Web browsers are supported: <ul style="list-style-type: none"> • Windows 7: <ul style="list-style-type: none"> ◦ Google Chrome v25 ◦ FireFox v15 ◦ Opera v12 ◦ Microsoft Internet Explorer v9 • Windows XP: <ul style="list-style-type: none"> ◦ Google Chrome v25 ◦ FireFox v15 • Apple Mac: <ul style="list-style-type: none"> ◦ Google Chrome v25 ◦ FireFox v20 ◦ Opera v12.14 ◦ Safari v6
POWER CONSUMPTION:	100-240V AC, 22VA
OPERATING TEMPERATURE:	0° to +40°C (32° to 104°F)
STORAGE TEMPERATURE:	-40° to +70°C (-40° to 158°F)
HUMIDITY:	10% to 90%, RHL non-condensing
DIMENSIONS:	43.6cm x 18.3cm x 4.36cm (17.2" x 7.2" x 1.7") W, D, H
WEIGHT:	1.65kg (3.63lb)
SHIPPING DIMENSIONS:	55cm x 27.6cm x 10.7cm (21.7" x 10.9" x 4.2") W, D, H
SHIPPING WEIGHT:	2.5kg (5.5lb)
INCLUDED ACCESSORIES:	Power cord, rack "ears"
OPTIONAL:	External remote IR receiver cable
Specifications are subject to change without notice at http://www.kramerelectronics.com	

12 Default Communication Parameters

RS-232	
Protocol 3000	
Baud Rate:	115,200
Data Bits:	8
Stop Bits:	1
Parity:	None
Command Format:	ASCII
TCP/IP Parameters	
IP Address:	192.168.1.39
Netmask:	255.255.0.0
Gateway:	0.0.0.0
TCP Port #:	5000
UDP Port #:	50000

13 Default EDID

Monitor

Model name..... VS-62H
Manufacturer..... KMR
Plug and Play ID..... KMR0200
Serial number..... 1
Manufacture date..... 2010, ISO week 24
Filter driver..... None

EDID revision..... 1.3
Input signal type..... Digital (DVI)
Color bit depth..... Undefined
Display type..... RGB color
Screen size..... 700 x 390 mm (31.5 in)
Power management..... Not supported
Extension blocs..... 1 (CEA-EXT)

DDC/CI..... n/a

Color characteristics

Default color space..... Non-sRGB
Display gamma..... 2.20
Red chromaticity..... Rx 0.640 - Ry 0.341
Green chromaticity..... Gx 0.286 - Gy 0.610
Blue chromaticity..... Bx 0.146 - By 0.069
White point (default).... Wx 0.284 - Wy 0.293
Additional descriptors... None

Timing characteristics

Horizontal scan range.... 31-94kHz
Vertical scan range..... 50-85Hz
Video bandwidth..... 170MHz
CVT standard..... Not supported
GTF standard..... Not supported
Additional descriptors... None
Preferred timing..... Yes
Native/preferred timing., 1280x720p at 60Hz
Modeline..... *1280x720* 74.250 1280 1390 1430 1650 720 725 730 746 +hsync -vsync
Detailed timing #1..... 1920x1080p at 60Hz (16:9)
Modeline..... *1920x1080* 148.500 1920 2008 2052 2200 1080 1084 1089 1125 +hsync +vsync

Standard timings supported

720 x 400p at 70Hz - IBM VGA
720 x 400p at 88Hz - IBM XGA2
640 x 480p at 60Hz - IBM VGA
640 x 480p at 67Hz - Apple Mac II
640 x 480p at 72Hz - VESA
640 x 480p at 75Hz - VESA
800 x 600p at 56Hz - VESA
800 x 600p at 60Hz - VESA
800 x 600p at 72Hz - VESA
800 x 600p at 75Hz - VESA
832 x 624p at 75Hz - Apple Mac II
1024 x 768i at 87Hz - IBM
1024 x 768p at 60Hz - VESA
1024 x 768p at 70Hz - VESA
1024 x 768p at 75Hz - VESA
1280 x 1024p at 75Hz - VESA
1152 x 870p at 75Hz - Apple Mac II
1280 x 720p at 60Hz - VESA STD
1280 x 800p at 60Hz - VESA STD
1440 x 900p at 60Hz - VESA STD
1280 x 960p at 60Hz - VESA STD
1280 x 1024p at 60Hz - VESA STD
1400 x 1050p at 60Hz - VESA STD
1680 x 1050p at 60Hz - VESA STD
1600 x 1200p at 60Hz - VESA STD

EIA/CEA-861 Information

Revision number..... 3
IT underscan..... Not supported
Basic audio..... Supported
YCbCr 4:4:4..... Supported
YCbCr 4:2:2..... Supported
Native formats..... 1

Detailed timing #1..... 720x480p at 60Hz (4:3)
 Modeline..... "720x480" 27.000 720 736 798 858 480 489 495 525 -hsync -vsync
 Detailed timing #2..... 1920x1080i at 60Hz (16:9)
 Modeline..... "1920x1080" 74.250 1920 2008 2052 2200 1080 1084 1094 1124 interlace +hsync +vsync
 Detailed timing #3..... 1920x1080i at 50Hz (16:9)
 Modeline..... "1920x1080" 74.250 1920 2048 2492 2640 1080 1084 1094 1124 interlace +hsync +vsync
 Detailed timing #4..... 1280x720p at 60Hz (16:9)
 Modeline..... "1280x720" 74.250 1280 1390 1430 1650 720 725 730 750 +hsync +vsync
 Detailed timing #5..... 1280x720p at 50Hz (16:9)
 Modeline..... "1280x720" 74.250 1280 1720 1760 1980 720 725 730 750 +hsync +vsync

CE video identifiers (VICs) - timing/formats supported

720 x 576p at 50Hz - EDTV (4:3, 16:15)
 1280 x 720p at 50Hz - HDTV (16:9, 1:1)
 1920 x 1080i at 60Hz - HDTV (16:9, 1:1)
 1920 x 1080i at 50Hz - HDTV (16:9, 1:1)
 1280 x 720p at 60Hz - HDTV (16:9, 1:1) [Native]
 1920 x 1080p at 60Hz - HDTV (16:9, 1:1)
 1920 x 1080p at 50Hz - HDTV (16:9, 1:1)
 NB: NTSC refresh rate = (Hz*1000)/1001

CE audio data (formats supported)

LPCM 3-channel, 24-bits at 44/48 kHz

CE speaker allocation data

Channel configuration.... 3,0
 Front left/right..... Yes
 Front LFE..... No
 Front center..... Yes
 Rear left/right..... No
 Rear center..... No
 Front left/right center.. No
 Rear left/right center... No
 Rear LFE..... No

CE vendor specific data (VSDB)

IEEE registration number. 0x000C03
 CEC physical address..... 1.0.0.0
 Maximum TMDS clock..... 165MHz

Raw data

00,FF,FF,FF,FF,FF,FF,00,2E,4D,00,02,01,00,00,00,18,14,01,03,81,46,27,78,0A,D5,7C,A3,57,49,9C,25,
 11,48,4B,FF,FF,80,81,C0,81,00,95,00,81,40,81,80,90,40,B3,00,A9,40,01,1D,00,72,51,D0,1A,20,6E,28,
 55,00,7E,88,42,00,00,1A,02,3A,80,18,71,38,2D,40,58,2C,45,00,C4,8E,21,00,00,1E,00,00,00,FC,00,56,
 53,2D,34,32,48,4E,0A,20,20,00,00,00,00,00,FD,00,32,55,1F,5E,11,00,0A,20,20,20,20,20,01,7B,
 02,03,1A,71,47,11,13,05,14,84,10,1F,23,0A,06,04,83,05,00,00,65,03,0C,00,10,00,8C,0A,D0,8A,20,E0,
 2D,10,10,3E,96,00,58,C2,21,00,00,18,01,1D,80,18,71,1C,16,20,58,2C,25,00,C4,8E,21,00,00,9E,01,1D,
 80,D0,72,1C,16,20,10,2C,25,80,C4,8E,21,00,00,9E,01,1D,00,72,51,D0,1E,20,6E,28,55,00,C4,8E,21,00,
 00,1E,01,1D,00,BC,52,D0,1E,20,B8,28,55,40,C4,8E,21,00,00,1E,00,00,00,00,00,00,00,00,00,00,90

14 Protocol 3000 Syntax

With Kramer Protocol 3000 you can control a device from any standard terminal software (for example, the Windows® HyperTerminal Application) or from TCP/UDP clients connected to default TCP port 5000 or UDP port 50000 (port numbers can be changed by the user). RS-232/RS-485 communications protocol uses a data rate of 115200 bps, no parity, 8 data bits, and 1 stop bit.

14.1 Host Message Format

Start	Address (opt)	Body	Delimiter
#	Destination_id@	Message	CR

14.1.1 Simple Command

Command string with only one command without addressing:

Start	Body	Delimiter
#	Command SP Parameter_1,Parameter_2,...	CR

14.1.2 Command String

Formal syntax with commands concatenation and addressing:

Start	Address	Body	Delimiter
#	Destination_id@	Command_1 Parameter1_1,Parameter1_2,... Command_2 Parameter2_1,Parameter2_2,... Command_3 Parameter3_1,Parameter3_2,...	CR

14.2 Device Message Format

Start	Address (opt)	Body	Delimiter
~	Sender_id@	Message	CR LF

14.2.1 Device Long Response

Echoing command:

Start	Address (opt)	Body	Delimiter
~	Sender_id@	Command SP [Param1,Param2 ...] result	CR LF

CR = Carriage return (ASCII 13 = 0x0D)

LF = Line feed (ASCII 10 = 0x0A)

SP = Space (ASCII 32 = 0x20)

14.3 Command Terms

Command

A sequence of ASCII letters ('A'-'Z', 'a'-'z' and '-').

Command and parameters must be separated by at least one space.

Parameters

A sequence of alphanumeric ASCII characters ('0'-'9', 'A'-'Z', 'a'-'z' and some special characters for specific commands). Parameters are separated by commas.

Message string

Every command entered as part of a message string begins with a **message starting character** and ends with a **message closing character**.

Note: A string can contain more than one command. Multiple commands are separated by a pipe (|) character.

Message starting character

'#' - For host command/query

'-' - For machine response or machine command performed by keystroke operation on the front panel or IR remote controller.

Device address (Optional when directly connected to the device)

K-Net Device ID or MACHINE NUMBER followed by '@'

(ex. #02@**CR LF**)

Query sign

'?' follows some commands to define a query request.

All outputs sign

'*' defines all outputs.

Message closing character

CR - For host messages; carriage return (ASCII 13)

`CR LF` - For machine messages; carriage return (ASCII 13) + line-feed (ASCII 10)

Command chain separator character

When a message string contains more than one command, a pipe (|) character separates each command.

Spaces between parameters or command terms are ignored.

14.4 Entering Commands

You can directly enter all commands using a terminal with ASCII communication software, such as HyperTerminal, Hercules, etc. Connect the terminal to the serial, Ethernet, or USB port on the Kramer device. To enter CR, press the Enter key. (LF is also sent but is ignored by the command parser).

For commands sent from some non-Kramer controllers such as Crestron, some characters require special coding (such as, /X##). Refer to the controller manual.

14.5 Bidirectional Definition

All commands are bidirectional. That is, if the device receives the code, it performs the instruction. If the instruction is performed (due to a keystroke operation on the front panel or IR controller) these codes are sent to the PC or other RS-232 / Ethernet / USB controller.

14.6 Command Chaining

Multiple commands can be chained in the same string. Each command is delimited by a pipe character (|). When chaining commands, enter the **message starting character** and the **message closing character** once only, at the beginning of the string and at the end.

Commands in the string do not execute until the closing character is entered. A separate response is sent for every command in the chain.

14.7 Maximum String Length

64 characters (except for special commands that are defined in the command syntax description).

15 Protocol 3000 Commands

This section lists and describes all the commands of Protocol 3000.

- System Commands - Mandatory (see [Section 15.1](#))
- System Commands (see [Section 15.2](#))
- Switching/Routing Commands (see [Section 15.3](#))
- Video Commands (see [Section 15.4](#))
- Audio Commands (see [Section 15.5](#))
- Communication Commands (see [Section 15.6](#))
- EDID Handling Commands (see [Section 15.7](#))
- Step-in Commands (see [Section 15.8](#))

15.1 System Commands - Mandatory

All devices running Protocol 3000 use these commands.

Command	Description	Type	Permission
#	Protocol handshaking	System-mandatory	End User
BUILD-DATE?	Get device build date	System-mandatory	End User
FACTORY	Reset to factory default configuration	System-mandatory	End User
HELP	Get command list	System-mandatory	End User
MODEL?	Get device model	System-mandatory	End User
PROT-VER?	Get device protocol version	System-mandatory	End User
RESET	Reset device	System-mandatory	Administrator
SN?	Get device serial number	System-mandatory	End User
VERSION?	Get device firmware version	System-mandatory	End User

Command - #		Command Type - System-mandatory	
Command Name		Permission	Transparency
Set:	#	End User	Public
Get:	-	-	-
Description		Syntax	
Set:	Protocol handshaking	#	
Get:	-	-	
Response			
~nn@spok _{CR LF}			
Parameters			
Response Triggers			
Notes			
Validates the Protocol 3000 connection and gets the machine number Step-in master products use this command to identify the availability of a device			

Command - BUILD-DATE		Command Type - System-mandatory	
Command Name		Permission	Transparency
Set:	-	-	-
Get:	BUILD-DATE?	End User	Public
Description		Syntax	
Set:	Get device build date	# BUILD-DATE <input type="checkbox"/>	
Get:	-	-	
Response			
- <input type="checkbox"/> @ BUILD-DATE <input type="checkbox"/> _ <input type="checkbox"/> date <input type="checkbox"/> _ <input type="checkbox"/> time <input type="checkbox"/> <input type="checkbox"/>			
Parameters			
<i>date</i> - Format: YYYY/MM/DD where YYYY = Year, MM = Month, DD = Day			
<i>time</i> - Format: hh:mm:ss where hh = hours, mm = minutes, ss = seconds			
Response Triggers			
Notes			

Command - FACTORY		Command Type - System-mandatory	
Command Name		Permission	Transparency
Set:	FACTORY	End User	Public
Get:	-	-	-
Description		Syntax	
Set:	Reset device to factory default configuration	# FACTORY <input type="checkbox"/>	
Get:	-	-	
Response			
- <input type="checkbox"/> @ FACTORY <input type="checkbox"/> _ <input type="checkbox"/> OK <input type="checkbox"/> <input type="checkbox"/>			
Parameters			
Response Triggers			
Notes			
This command deletes all user data from the device. The deletion can take some time. Your device may require powering off and powering on for the changes to take effect.			

Command - HELP		Command Type - System-mandatory	
Command Name		Permission	Transparency
Set:	-	-	-
Get:	HELP	End User	Public
Description		Syntax	
Set:	-	-	
Get:	Get command list or help for specific command	2 options: 1. #HELP _{CR} 2. #HELP _{SP} <i>command_name</i> _{CR}	
Response			
1. Multi-line: ~ _{nn} @ Device available protocol 3000 commands: _{CR LF} <i>command</i> _{SP} <i>command...</i> _{CR LF} To get help for command use: HELP (COMMAND_NAME) _{CR LF}			
2. Multi-line: ~ _{nn} @ HELP _{SP} <i>command</i> : _{CR LF} <i>description</i> _{CR LF} USAGE : <i>usage</i> _{CR LF}			
Parameters			
Response Triggers			
Notes			

Command - MODEL?		Command Type - System-mandatory	
Command Name		Permission	Transparency
Set:	-	-	-
Get:	MODEL?	End User	Public
Description		Syntax	
Set:	-	-	
Get:	Get device model	#MODEL? _{CR}	
Response			
~ _{nn} @ MODEL _{SP} <i>model_name</i> _{CR LF}			
Parameters			
model_name - String of up to 19 printable ASCII chars			
Response Triggers			
Notes			
This command identifies equipment connected to Step-in master products and notifies of identity changes to the connected equipment. The Matrix saves this data in memory to answer REMOTE-INFO requests			

Command - PROT-VER?		Command Type - System-mandatory	
Command Name		Permission	Transparency
Set:	-	-	-
Get:	PROT-VER?	End User	Public
Description		Syntax	
Set:	-	-	
Get:	Get device protocol version	# PROT-VER? <input type="checkbox"/> CR	
Response			
~nn@ PROT-VER <input type="checkbox"/> SP3000:version <input type="checkbox"/> CR LF			
Parameters			
Version - XX.XX where X is a decimal digit			
Response Triggers			
Notes			

Command - RESET		Command Type - System-mandatory	
Command Name		Permission	Transparency
Set:	RESET	Administrator	Public
Get:	-	-	-
Description		Syntax	
Set:	Reset device	# RESET <input type="checkbox"/> CR	
Get:	-	-	
Response			
~nn@ RESET <input type="checkbox"/> SPOK <input type="checkbox"/> CR LF			
Parameters			
Response Triggers			
Notes			
To avoid locking the port due to a USB bug in Windows, disconnect USB connections immediately after running this command. If the port was locked, disconnect and reconnect the cable to reopen the port.			

Command - SN?		Command Type - System-mandatory	
Command Name		Permission	Transparency
Set:	-	-	-
Get:	SN?	End User	Public
Description		Syntax	
Set:	-	-	
Get:	Get device serial number	# SN? _{CR}	
Response			
~ nn @ SN _{SP} serial_number _{CR LF}			
Parameters			
serial_number - 11 decimal digits, factory assigned			
Response Triggers			
Notes			
For new products with 14 digit serial numbers, use only the last 11 digits			

Command - VERSION?		Command Type - System-mandatory	
Command Name		Permission	Transparency
Set:	-	-	-
Get:	VERSION?	End User	Public
Description		Syntax	
Set:	-	-	
Get:	Get firmware version number	# VERSION? _{CR}	
Response			
~ nn @ VERSION _{SP} firmware_version _{CR LF}			
Parameters			
firmware_version - XX.XX.XXXX where the digit groups are: major.minor.build version			
Response Triggers			
Notes			

15.2 System Commands

Command	Description	Type	Permission
AV-SW-MODE	Set/get auto switch mode	System	End user
BAUD	Set/get protocol serial port baud rate	System	End User
DISPLAY?	Get output HPD status	Switch	End User
HDCP-MOD	Set/get HDCP mode	System	Administrator
HDCP-STAT?	Get HDCP signal status	System	End user
LDFW	Load new firmware file	System	End User Internal SW
LOCK-FP	Set/get front panel lock	System	Administrator
NAME	Set/get machine (DNS) name	System	Administrator
NAME-RST	Reset machine name to factory default (DNS)	System	Administrator
PRI0	Set/get input priority	System	Administrator
SIGNAL?	Get input signal lock status	System	End User

Command - AV-SW-MODE		Command Type - System	
Command Name		Permission	Transparency
Set:	AV-SW-MODE	End user	Public
Get:	AV-SW-MODE?	End user	Public
Description		Syntax	
Set:	Set input auto switch mode (per output)	# AV-SW-MODE _[SP] layer,output_id,mode _[CR]	
Get:	Get input auto switch mode (per output)	# AV-SW-MODE? _[SP] layer,output_id _[CR]	
Response			
~nn@AV-SW-MODE _[SP] layer,output_id,mode _[CR] LF			
Parameters			
<i>layer</i> – see Section 18.14 Layer Enumeration <i>output_id</i> - 1....num of system outputs <i>mode</i> - 0 - manual 1 - priority switch 2 - last connected switch			
Response Triggers			
Notes			

Command - BAUD		Command Type - System	
Command Name		Permission	Transparency
Set:	BAUD	Administrator	Public
Get:	BAUD?	Administrator	Public
Description		Syntax	
Set:	Set protocol serial port baud rate	# BAUD _{SP} <i>baud_rate</i> _{CR}	
Get:	Get protocol serial port baud rate (Option 1 - for current baud rate, Option 2 - for list of supported baud rates)	Option 1: # BAUD? _{CR} Option 2: # BAUD? _{SP} <i>baud_param</i> _{CR}	
Response			
~ _{nn} @ BAUD _{SP} <i>baud_rate</i> _{CR LF}			
Option 1: ~ _{nn} @ BAUD _{SP} <i>current_baud_rate</i> _{CR LF}			
Option 2: ~ _{nn} @ BAUD _{SP} <i>baud_rate1, baud_rate2,...</i> _{CR LF}			
Parameters			
<i>baud_rate</i> - 9600 / 115200 / else - new baud rate to set			
<i>current_baud_rate</i> - 9600 / 115200 / else - current protocol serial port baud rate			
<i>baud_param</i> - 0 - get the list of supported baud rates			
<i>baud_rate1, baud_rate2, ...</i> - list of supported baud rates			
Response Triggers			
Notes			
The new defined baud rate is stored in the EEPROM and used when powering up			
Default baud rate is 115200 (on factory reset)			
Only works with devices supporting this command (if <i>ERR 002</i> is returned, the default baud rate is used)			

Command - DISPLAY?		Command Type - System	
Command Name		Permission	Transparency
Set:	-	-	-
Get	DISPLAY?	End User	Public
Description		Syntax	
Set:	-	-	
Get:	Get output HPD status	# DISPLAY? _[SP] <i>out_id</i> _[CR]	
Response			
~ _[nn] @ DISPLAY? _[SP] <i>out_id,status</i> _[CR LF]			
Parameters			
<i>out_id</i> - output number <i>status</i> - HPD status according to signal validation (see Section 18.18 Signal Validation)			
Response Triggers			
After execution, response is sent to the com port from which the Get was received Response is sent after every change in output HPD status ON to OFF Response is sent after every change in output HPD status OFF to ON and ALL parameters (new EDID, etc.) are stable and valid			
Notes			

Command - HDCP-MOD		Command Type - System	
Command Name		Permission	Transparency
Set:	HDCP-MOD	Administrator	Public
Get:	HDCP-MOD?	End User	Public
Description		Syntax	
Set:	Set HDCP mode	# HDCP-MOD _[SP] <i>inp_id,mode</i> _[CR]	
Get:	Get HDCP mode	# HDCP-MOD? _[SP] <i>stage_id</i> _[CR]	
Response			
Set / Get: ~ _[nn] @ HDCP-MOD _[SP] <i>stage_id,mode</i> _[CR LF]			
Parameters			
<i>inp_id</i> - input number (1.. max number of inputs) <i>mode</i> - HDCP mode (see Section 18.20 - HDCP Types)			
Response Triggers			
Response is sent to the com port from which the Set (before execution) / Get command was received Response is sent to all com ports after execution if HDCP-MOD was set by any other external control device (button press, device menu and similar) or HDCP mode changed			
Notes			
Set HDCP working mode on the device input: HDCP supported - HDCP_ON [default] HDCP not supported - HDCP OFF HDCP support changes following detected sink - MIRROR OUTPUT			

Command - HDCP-STAT		Command Type - System	
Command Name		Permission	Transparency
Set:	-	-	-
Get:	HDCP-STAT?	End User	Public
Description		Syntax	
Set:	None	-	
Get:	Get HDCP signal status	#HDCP-STAT? <input type="checkbox"/> stage,stage_id <input type="checkbox"/>	
Response			
Set / Get: ~ <input type="checkbox"/> @HDCP-STAT <input type="checkbox"/> stage,stage_id,mode <input type="checkbox"/> LF			
Parameters			
<i>stage</i> – input/output (see Section 18.2 Stage) <i>stage_id</i> - number of chosen stage (1.. max number of inputs/outputs) <i>actual_status</i> - signal encryption status - valid values ON/OFF (see Section 18.20 HDCP Types)			
Response Triggers			
Response is sent to the com port from which the Set (before execution) / Get command was received Response is sent to all com ports after execution if HDCP-STAT was set by any other external control device (button press, device menu and similar) or HDCP mode changed			
Notes			
On output – sink status On input – signal status			

Command - LDFW		Command Type - System - Packets	
Command Name		Permission	Transparency
Set:	LDFW	Internal SW	Public
Get:	-	-	-
Description		Syntax	
Set:	Load new firmware file	Step 1: #LDFW _{SP} size _{CR} Step 2: If ready was received, send <u>FIRMWARE_DATA</u>	
Get:	-	-	
Response			
Response 1: ~hn@LDFW _{SP} size _{SP} READY _{CR LF} or ~hn@LDFW _{SP} ERRnn _{CR LF}			
Response 2: ~hn@LDFW _{SP} size _{SP} OK _{CR LF}			
Parameters			
size - size of firmware data that is sent			
<u>FIRMWARE_DATA</u> - HEX or KFW file in protocol packets (see Section 4)			
Response Triggers			
Notes			
In most devices firmware data is saved to flash memory, but the memory does not update until receiving the "UPGRADE" command and is restarted. See Protocol Packet reference in Section 17 . Use this command in dedicated SW application			

Command - LOCK-FP		Command Type - System	
Command Name		Permission	Transparency
Set:	LOCK-FP	End User	Public
Get:	LOCK-FP?	End User	Public
Description		Syntax	
Set:	Lock front panel	Option 1: # LOCK-FP _[SP] /lock_mode _[CR] Option 2: # LOCK-FP _[SP] device_id,lock_mode _[CR]	
Get:	Get front panel lock state	Option 1: # LOCK-FP? _[CR] Option 2: # LOCK-FP? _[SP] device_id _[CR]	
Response			
Set: Option 1: ~nn@ LOCK-FP _[SP] /lock_mode _[SP] OK _[CR LF] Option 2: ~01@ LOCK-FP _[SP] device_id,lock_mode _[SP] OK _[CR LF]			
Get: Option 1: ~nn@ LOCK-FP _[SP] /lock_mode _[CR LF] Option 2: ~01@ LOCK-FP _[SP] device_id,lock_mode _[CR LF]			
Parameters			
<i>lock_mode</i> - 0/OFF - unlocks the front panel buttons, 1/ON - locks the front panel buttons <i>device_id</i> - for K-Net controllers, select the button panel to lock. Locking is allowed only from the master			
Response Triggers			
Notes			

Command - NAME		Command Type - System (Ethernet)	
Command Name		Permission	Transparency
Set:	NAME	Administrator	Public
Get:	NAME?	End User	Public
Description		Syntax	
Set:	Set machine (DNS) name	#NAME _[SP] machine_name _[CR LF]	
Get:	Get machine (DNS) name	#NAME? _[CR]	
Response			
Set:	~nn@NAME _[SP] machine_name _[CR LF]		
Get:	~nn@NAME? _[SP] machine_name _[CR LF]		
Parameters			
<i>machine_name</i> - String of up to 14 alpha-numeric chars (can include hyphen, not at the beginning or end)			
Response Triggers			
Notes			
The machine name is not the same as the model name. The machine name is used to identify a specific machine or a network in use (with DNS feature on)			

Command - NAME-RST		Command Type - System (Ethernet)	
Command Name		Permission	Transparency
Set:	NAME-RST	Administrator	Public
Get:	-	-	-
Description		Syntax	
Set:	Reset machine (DNS) name to factory default	#NAME-RST _[CR]	
Get:	-	-	
Response			
	~nn@NAME-RST _[SP] OK _[CR LF]		
Parameters			
Response Triggers			
Notes			
Factory default of machine (DNS) name is "KRAMER_" + 4 last digits of device serial number			

Command - PRIO		Command Type - System	
Command Name		Permission	Transparency
Set:	PRIO	Administrator	Public
Get	PRIO?	Administrator	Public
Description		Syntax	
Set:	Set input priority	#PRIO _{SP} input_id,prio _{CR}	
Get:	Get input priority	#PRIO? _{SP} input_id _{CR}	
Response			
~ _{nn} @PRIO _{SP} input_id,prio _{CR LF}			
Parameters			
<i>input_id</i> - window number setting new source <i>prio</i> - assigned priority (1.. max priority)			
Response Triggers			
After execution, response is sent to the com port from which the Set/Get was received After execution, response is sent to all com ports if PRIO was set by any other external control device (button press, device menu and similar)			
Notes			
The PRIO max value may vary for different devices			

Command - SIGNAL		Command Type - System	
Command Name		Permission	Transparency
Set:	-	-	-
Get	SIGNAL?	End User	Public
Description		Syntax	
Set:	-	-	
Get:	Get input signal lock status	#SIGNAL? _{SP} inp_id _{CR}	
Response			
~ _{nn} @SIGNAL _{SP} inp_id,status _{CR LF}			
Parameters			
<i>inp_id</i> - input number <i>status</i> - lock status according to signal validation (see Section 18.18 Signal Validation)			
Response Triggers			
After execution, a response is sent to the com port from which the Get was received Response is sent after every change in input signal status ON to OFF, or OFF to ON			
Notes			

15.3 Switching/Routing Commands

Note: Use the **ROUTE** command in preference to legacy AUD, VID, and AV commands (see below).

Command	Description	Type	Permission
AFV	Set/get audio follow video mode	Switching	End User
AUD	Set/get audio switch state	Switching	End User
ROUTE	Set/get layer routing	Routing	End User
VID	Set/get video switch state	Switching	End User

Command - AFV		Command Type - Switching	
Command Name		Permission	Transparency
Set:	AFV	End User	Public
Get:	AFV?	End User	Public
Description		Syntax	
Set:	Set audio follow video/audio breakaway mode	#AFV _{SP} afv_mode _{CR}	
Get:	Get audio follow video mode status	#AFV? _{CR}	
Response			
~nn@AFV _{SP} afv_mode _{CR LF}			
Parameters			
afv_mode - front panel AFV mode 0/afv - sets the unit to the audio-follow-video switching mode 1/brk - sets the unit to the audio breakaway switching mode			
Response Triggers			
Notes			
When the unit moves from breakaway to audio follow video switching mode, all audio switch settings are reset according to the video switch settings.			

Command - AUD		Command Type - Switching	
Command Name		Permission	Transparency
Set:	AUD	End User	Public
Get:	AUD?	End User	Public
Description		Syntax	
Set:	Set audio switch state	#AUD _{SP} in>out, in>out,... _{CR}	
Get:	Get audio switch state	#AUD? _{SP} out _{CR} #AUD? _{SP} * _{CR}	
Response			
Set: ~nn@AUD _{SP} in>out _{CR LF} ~nn@AUD _{SP} in>out _{CR LF} ... Get: ~nn@AUD _{SP} in>out _{CR LF} ~nn@AUD _{SP} in>1,in>2,... _{CR LF}			
Parameters			
<i>In</i> - input number or '0' to disconnect output > - connection character between in and out parameters <i>out</i> - output number or '*' for all outputs			
Response Triggers			
Notes			
When AFV switching mode is active, this command also switches video and the unit replies with command ~AV			

Command - ROUTE		Command Type - Routing	
Command Name		Permission	Transparency
Set:	ROUTE	End User	Public
Get:	ROUTE?	End User	Public
Description		Syntax	
Set:	Set layer routing	# ROUTE _[SP] <i>layer, dest, src</i> _[CR]	
Get:	Get layer routing	# ROUTE? _[SP] <i>layer, dest</i> _[CR]	
Response			
~ _[nn] @ ROUTE _[SP] <i>layer, dest, src</i> _[CR LF]			
Parameters			
<i>layer</i> - see Section 18.14 Layer Enumeration			
<i>dest</i> - * - ALL x - disconnect, otherwise destination id			
<i>src</i> - source id			
Response Triggers			
Notes			
This command replaces all other routing commands			
The GET command identifies input switching on Step-in clients			
The SET command is for remote input switching on Step-in clients (essentially via by the Web)			

Command - VID		Command Type - Switching	
Command Name		Permission	Transparency
Set:	VID	End User	Public
Get:	VID?	End User	Public
Description		Syntax	
Set:	Set video switch state	# VID _[SP] <i>in>out</i> _[CR]	
Get:	Get video switch state	# VID? _[SP] <i>out</i> _[CR]	
Response			
Set: ~ _[nn] @ VID _[SP] <i>in>out</i> _[CR LF]			
Get: ~ _[nn] @ VID _[SP] <i>in>out</i> _[CR LF]			
Parameters			
<i>in</i> - input number or '0' to disconnect output			
> - connection character between in and out parameters			
<i>out</i> - output number or '*' for all outputs			
Response Triggers			
Notes			
The GET command identifies input switching on Step-in clients			
The SET command is for remote input switching on Step-in clients (essentially via by the Web)			
This is a legacy command. New Step-in modules support the ROUTE command			

15.4 Video Commands

Command	Description	Type	Permission
DEF-RES	Set/get custom defined scaled video output resolution to "VIC" index	Video	Administrator
VID-PATTERN	Set/get test pattern on output	Video	End User
VMUTE	Set/get video on output mute	Video	End User

Command - DEF-RES		Command Type - Video	
Command Name		Permission	Transparency
Set	DEF-RES	Administrator	Public
Get	DEF-RES?	End User	Public
Description		Syntax	
Set:	Set custom defined scaled video output resolution to ID index	#DEF-RES _{SP} Table_id,Width,Height,Htotal,VTotol,HSyncW,HSyncBackPorch, VSyncW,VSyncBackPorch,FrRate,Interlaced _{CR}	
Get:	Get custom defined video resolution	#DEF-RES? _{SP} Table_id,stage,stage_id _{CR}	
Response			
~ _{nn} @DEF-RES _{SP} Table_id,Width,Height,Htotal,VTotol,HSyncW,HSyncBackPorch,VSyncW,VSyncBackPorch,FrRate,Interlaced _{CR LF}			
Parameters			
<p><i>Table_id</i> - index in resolution table (see Section 18.5 Video Port Type)). Valid indexes for SET are 100-104 only <i>Custom resolution parameters</i> - by name (self-explanatory), numeric value <i>Interlaced</i> - interlaced/progressive according to Section 18.1 On/Off ("ON"- I, "OFF" - P) <i>Stage</i> - input/output (see Section 18.2 Stage) <i>Stage_id</i> - number of chosen stage (1...max number of inputs/outputs)</p>			
Response Triggers			
After execution, response is sent to the com port from which the Set/Get was received After execution, response is sent to all com ports if DEF-RES was set by any other external control device (button press, device menu and similar)			
Notes			
If a requested custom resolution is not defined, yet is in the device, it returns ERR _{SP} 003 (out of range) Only indexes 100-104 are valid for custom defined resolution In Get command when sending: index 0 - device replies with detailed info of native resolution index 255 - device replies with detailed info of current resolution			

Command – VID-PATTERN		Command Type – Video	
Command Name		Permission	Transparency
Set:	VID-PATTERN	End User	Public
Get:	VID-PATTERN?	End User	Public
Description		Syntax	
Set:	Set test pattern on output	#VID-PATTERN _[SP] output_id,pattern_id _[CR]	
Get :	Get test pattern on output	#VID-PATTERN? _[SP] output_id _[CR]	
Response			
~nn@VID-PATTERN _[SP] output_id,pattern_id _[CR]			
Parameters			
output_id - 1....num of system outputs pattern_id - 1....num of system patterns			
Response Triggers			
After execution, response is sent to the com port from which the Set/Get was received After execution, response is sent to all com ports if VID-PATTERN was set by any other external control device (button press, WEB, device menu and similar)			
Notes			

Command - VMUTE		Command Type - Video	
Command Name		Permission	Transparency
Set:	VMUTE	End User	Public
Get:	VMUTE?	End User	Public
Description		Syntax	
Set:	Set enable/disable video on output	#VMUTE _[SP] output_id, flag _[CR]	
Get:	Get video on output status	#VMUTE? _[SP] output_id _[SP] _[CR]	
Response			
Set / Get: ~nn@ VMUTE _[SP] output_id, flag _[CR LF]			
Parameters			
output_id - 1....num of system outputs flag - 0 - disable video on output 1 - enable video on output 2 - blank video			
Response Triggers			
Notes			

15.5 Audio Commands

These commands are used by audio devices running Protocol 3000.

Command	Description	Type	Permission
AUD-SIGNAL?	Get audio input signal status	Audio	End user
MUTE	Set/get audio mute	Audio	End User

Command - AUD-SIGNAL		Command Type - Audio	
Command Name		Permission	Transparency
Set:	-	-	-
Get	AUD-SIGNAL?	End User	Public
Description		Syntax	
Set:	-	-	
Get:	Get audio input signal status	# AUD-SIGNAL? _{SP} <i>inp_id</i> _{CR}	
Response			
~ nn @ AUD-SIGNAL _{SP} <i>inp_id</i> , <i>status</i> _{CR LF}			
Parameters			
<i>inp_id</i> - input number (1 .. max input number)			
<i>status</i> - 0 - OFF (no signal)			
1 - ON (signal present)			
Response Triggers			
After execution, response is sent to the com port from which the Get was received			
Response is sent to all com ports if audio status state was changed on any input			
Notes			

Command - MUTE		Command Type - Audio	
Command Name		Permission	Transparency
Set:	MUTE	End User	Public
Get:	MUTE?	End User	Public
Description		Syntax	
Set:	Set audio mute	#MUTE _{SP} channel,mute_mode _{CR}	
Get:	Get audio mute	#MUTE? _{SP} channel _{CR}	
Response			
~nn@MUTE _{SP} channel,mute_mode _{CR LF}			
Parameters			
<i>channel</i> - output number			
<i>mute_mode</i> - 0 or OFF / 1 or ON			
Response Triggers			
Notes			

15.6 Communication Commands

These commands are used by network devices running Protocol 3000.

Command	Description	Type	Permission
ETH-PORT	Set/get Ethernet port protocol	Communication	Administrator
NET-DHCP	Set/get DHCP mode	Communication	Administrator
NET-GATE	Set/get gateway IP	Communication	Administrator
NET-IP	Set/get IP address	Communication	Administrator
NET-MAC?	Get MAC address	Communication	End User
NET-MASK	Set/get subnet mask	Communication	Administrator

Command - ETH-PORT		Command Type - Communication	
Command Name		Permission	Transparency
Set:	ETH-PORT	Administrator	Public
Get:	ETH-PORT?	End User	Public
Description		Syntax	
Set:	Set Ethernet port protocol	# ETH-PORT _{SP} <i>portType</i> , <i>ETHPort</i> _{CR}	
Get:	Get Ethernet port protocol	# ETH-PORT? _{SP} <i>portType</i> _{CR}	
Response			
~ nn @ ETH-PORT _{SP} <i>portType</i> , <i>ETHPort</i> _{CR LF}			
Parameters			
<i>portType</i> - TCP/UDP			
<i>ETHPort</i> - TCP/UDP port number			
Response Triggers			
Notes			

Command - NET-DHCP		Command Type - Communication	
Command Name		Permission	Transparency
Set:	NET-DHCP	Administrator	Public
Get:	NET-DHCP?	End User	Public
Description		Syntax	
Set:	Set DHCP mode	# NET-DHCP _{SP} mode _{CR}	
Get:	Get DHCP mode	# NET-DHCP? _{CR}	
Response			
- _{nn} @ NET-DHCP _{SP} mode _{CR LF}			
Parameters			
mode - 0 - Do not use DHCP. Use the IP set by the factory or using the IP set command 1 - Try to use DHCP. If unavailable, use IP as above			
Response Triggers			
Notes			
Connecting Ethernet to devices with DHCP may take more time in some networks To connect with a randomly assigned IP by DHCP, specify the device DNS name (if available) using the command "NAME". You can also get an assigned IP by direct connection to USB or RS-232 protocol port if available For proper settings consult your network administrator			

Command - NET-GATE		Command Type - Communication	
Command Name		Permission	Transparency
Set:	NET-GATE	Administrator	Public
Get:	NET-GATE?	End User	Public
Description		Syntax	
Set:	Set gateway IP	# NET-GATE _{SP} ip_address _{CR}	
Get:	Get gateway IP	# NET-GATE? _{CR}	
Response			
- _{nn} @ NET-GATE _{SP} ip_address _{CR LF}			
Parameters			
ip_address - format: xxx.xxx.xxx.xxx			
Response Triggers			
Notes			
A network gateway connects the device via another network and maybe over the Internet. Be careful of security problems. For proper settings consult your network administrator			

Command - NET-IP		Command Type - Communication	
Command Name		Permission	Transparency
Set:	NET-IP	Administrator	Public
Get:	NET-IP?	End User	Public
Description		Syntax	
Set:	Set IP address	#NET-IP _[SP] ip_address _[CR]	
Get:	Get IP address	#NET-IP? _[CR]	
Response			
- _[n] @NET-IP _[SP] ip_address _[CR LF]			
Parameters			
ip_address - format: xxx.xxx.xxx.xxx			
Response Triggers			
Notes			
For proper settings consult your network administrator			

Command - NET-MAC?		Command Type - Communication	
Command Name		Permission	Transparency
Set:	-	-	-
Get:	NET-MAC?	End User	Public
Description		Syntax	
Set:	-	-	
Get:	Get MAC address	#NET-MAC? _[CR]	
Response			
- _[n] @NET-MAC _[SP] mac_address _[CR LF]			
Parameters			
mac_address - Unique MAC address. Format: XX-XX-XX-XX-XX-XX where X is hex digit			
Response Triggers			
Notes			

Command - NET-MASK		Command Type - Communication	
Command Name		Permission	Transparency
Set:	NET-MASK	Administrator	Public
Get:	NET-MASK?	End User	Public
Description		Syntax	
Set:	Set subnet mask	#NET-MASK _{SP} net_mask _{CR}	
Get:	Get subnet mask	#NET-MASK? _{CR}	
Response			
~nn@NET-MASK _{SP} net_mask _{CR LF}			
Parameters			
net_mask - format: xxx.xxx.xxx.xxx			
Response Triggers			
The subnet mask limits the Ethernet connection within the local network For proper settings consult your network administrator			
Notes			

15.7 EDID Handling Commands

Command	Description	Type	Permission
CPEDID	Copy EDID data from the output to the input EEPROM	EDID Handling	End User
GEDID	Set/get EDID data	EDID Handling	End User
LDEDID	Load EDID data	EDID Handling	End User

Command - CPEDID		Command Type - EDID Handling	
Command Name		Permission	Transparency
Set:	CPEDID	End User	Public
Get:	-	-	-
Description		Syntax	
Set:	Copy EDID data from the output to the input EEPROM	#CPEDID _{SP} src_type, src_id, dst_type, dest_bitmap _{CR}	
Get:	-	-	
Response			
~hh@CPEDID _{SP} src_stg, src_id, dst_type, dest_bitmap _{CR LF}			
Parameters			
<p>src_type - EDID source type (usually output) (see Section 18.16 EDID Source)</p> <p>src_id - number of chosen source stage (1.. max number of inputs/outputs)</p> <p>dst_type - EDID destination type (usually input) (see Section 18.16 EDID Source)</p> <p>dest_bitmap - bitmap representing destination IDs. Format: XXXX...X, where X is hex digit. The binary form of every hex digit represents corresponding destinations. Setting '1' says that EDID data has to be copied to this destination</p>			
Response Triggers			
Response is sent to the com port from which the Set was received (before execution)			
Notes			
<p>Destination bitmap size depends on device properties (for 64 inputs it is a 64-bit word)</p> <p>Example: bitmap 0x0013 means inputs 1,2 and 5 are loaded with the new EDID</p>			

Command - GEDID		Command Type - EDID Handling	
Command Name		Permission	Transparency
Set:	GEDID	Administrator	Public
Get:	GEDID?	End User	Public
Description		Syntax	
Set:	Set EDID data from device	# GEDID _[SP] <i>stage, stage_id</i> _[CR]	
Get:	Get EDID support on certain input/output	# GEDID? _[SP] <i>stage, stage_id</i> _[CR]	
Response			
Set:			
Multi-line response:			
~ nn @ GEDID _[SP] <i>stage,stage_id,size</i> _[CR LF]			
EDID_data _[CR LF]			
~ nn @ GEDID _[SP] <i>stage,stage_id</i> _[SP] OK _[CR LF]			
Get:			
~ nn @ GEDID _[SP] <i>stage,stage_id,size</i> _[CR LF]			
Parameters			
<i>stage</i> - input/output (see Section 18.16 EDID Source)			
<i>stage_id</i> - number of chosen stage (1.. max number of inputs/outputs)			
<i>size</i> - EDID data size. For Set, size of data to be sent from device, for Get, 0 means no EDID support			
Response Triggers			
Response is sent to the com port from which the Set (before execution) / Get command was received			
Notes			
For Get, size=0 means EDID is not supported			
For old devices that do not support this command, ~ nn @ ERR 002 _[CR LF] is received			

Command - LDEDID		Command Type - EDID Handling	
Command Name		Permission	Transparency
Set:	LDEDID	End User	Public
Get:	-	-	-
Description		Syntax	
Set:	Write EDID data from external application to device	Multi-step syntax (see following steps)	
Get:	None	None	
Communication Steps (Command and Response)			
Step 1: # LDEDID _{SP} <i>dst_type, dest_bitmask, size, safe_mode</i> _{CR}			
Response 1: ~ <i>nn</i> @ LDEDID _{SP} <i>dst_type, dest_bitmask, size, safe_mode</i> _{SP} READY _{CR LF} or ~ <i>nn</i> @ LDEDID _{SP} ERR <i>nn</i> _{CR LF}			
Step 2: If ready was received, send EDID_DATA			
Response 2: ~ <i>nn</i> @ LDEDID _{SP} <i>dst_type, dest_bitmask, size, safe_mode</i> _{SP} OK _{CR LF} or ~ <i>nn</i> @ LDEDID _{SP} ERR <i>nn</i> _{CR LF}			
Parameters			
<i>dst_type</i> - EDID destination type (usually input) (see Section 18.16 EDID Source)			
<i>dest_bitmask</i> - bitmap representing destination IDs. Format: 0x*****, where * is ASCII presentation of hex digit. The binary presentation of this number is a bit mask for destinations. Setting '1' means EDID data has to be copied to this destination			
<i>size</i> - EDID data size			
<i>safe_mode</i> - 0 - Device accepts the EDID as is without trying to adjust 1 - Device tries to adjust the EDID			
EDID_DATA - data in protocol packets (see Section 17)			
Response Triggers			
Response is sent to the com port from which the Set (before execution)			
Notes			
When the unit receives the LDEDID command it replies with READY and enters the special EDID packet wait mode. In this mode the unit can receive only packets and not regular protocol commands. If the unit does not receive correct packets for 30 seconds or is interrupted for more than 30 seconds before receiving all packets, it sends timeout error ~ <i>nn</i> @ LDEDID _{SP} ERR01 _{CR LF} and returns to the regular protocol mode. If the unit received data that is not a correct packet, it sends the corresponding error and returns to the regular protocol mode. See Protocol Packet reference in Section 17			

15.8 Step-in Commands

Command	Description	Type	Permission
PROG-ACTION	Set/get step-in button action list	Step-in	End User

Command - PROG-ACTION		Command Type - Step-in	
Command Name		Permission	Transparency
Set:	PROG-ACTION	End user	Public
Get:	PROG-ACTION?	End user	Public
Description		Syntax	
Set:	Set step-in button action bitmap	# PROG-ACTION _{SP} <i>type, port_id, button_id, actions_bitmap</i> _{CR}	
Get:	Get step-in button action bitmap	# PROG-ACTION? _{SP} <i>port_type, port_id, button_id</i> _{CR}	
Response			
~ _{nn} @ PROG-ACTION _{SP} <i>port_type, port_id, button_id, actions_bitmap</i> _{CR LF}			
Parameters			
<p><i>port_type</i> - input/output (see Section 18.2 Stage)</p> <p><i>port_id</i> - port id</p> <p><i>button_id</i> - external programmable button ID</p> <p><i>actions_bitmap</i> – bitmap representing actions to perform after receiving <i>button_id</i>. format: XXXX...X, where X is a hex digit. The binary form of every hex digit represents actions from the table (see Section 18.15 Software Programmed). Setting '1' says that the corresponding action must be executed</p>			
Response Triggers			
Notes			
Programs matrix action as a response for external event (programmable button pressed)			

16 Messages and Codes

16.1 Device Initiated Messages

Command	Syntax
Start message	~nn@Protocol Start<CR><LF>
Switcher actions:	
Audio-video channel has switched (AFV mode)	~nn@AV<SP>in>out<CR><LF>
Video channel has switched (breakaway mode)	~nn@VID<SP>in>out<CR><LF>
Audio channel has switched (breakaway mode)	~nn@AUD<SP>in>out<CR><LF>

16.2 Result and Error Codes

16.2.1 Syntax

In case of an error, the device responds with an error message. The error message syntax:

~NN@ ERR XXX<CR><LF> - when general error, no specific command

~NN@CMD ERR XXX<CR><LF> - for specific command

NN - machine number of device, default = 01

XXX - error code

16.2.2 Error Codes

Error	Description
0	No error
1	Protocol syntax
2	Command not available
3	Parameter out of range
4	Unauthorized access
5	Internal FW error
6	Protocol busy
7	Wrong CRC
8	Timeout
9	(Reserved)
10	Not enough space for data (firmware, FPGA...)
11	Not enough space - file system
12	File does not exist
13	File can't be created
14	File can't open
15-20	(Reserved)
21	Packet CRC error
22	Packet number isn't expected (missing packet)
23	Packet size wrong
24-29	(Reserved)
30	EDID corrupted
31-39	Device specific errors

17 Packet Protocol Structure

The packet protocol is designed to transfer large amounts of data, such as files, IR commands, EDID data, etc.

17.1 Using the Packet Protocol

To use the packet protocol:

10. Send a command: LDRV, LOAD, IROUT, LDEDID

11. Receive Ready or ERR###

12. If Ready:

- Send a packet
- Receive OK on the last packet
- Receive OK for the command

13. Packet structure:

- Packet ID (1, 2, 3...) (2 bytes in length)
- Length (data length + 2 for CRC) - (2 bytes in length)
- Data (data length -2 bytes)
- CRC - 2 bytes

01	02	03	04	05...	
Packet ID		Length		Data	CRC

14. Response:

~NNNN **S** **P** **O** **K** **C** **R** **L** **F**

Where NNNN is the received packet ID in ASCII hex digits.

17.2 Calculating the CRC

The polynomial for the 16-bit CRC is:

CRC-CCITT: $0x1021 = x^{16} + x^{12} + x^5 + 1$

Initial value: 0000

Final XOR Value: 0

For a code example, see:

http://sanity-free.org/133/crc_16_ccitt_in_csharp.html

CRC example:

Data = "123456789"

Result => 0x31C3

18 Parameters

18.1 On/Off

Number	Value
0	Off
1	On

18.2 Stage

Number	Value
0	Input
1	Output
2	(Reserved)
3	(Reserved)

18.3 Signal Type

Number	Value
0	No signal
1	DVI
2	HDMI
3	DisplayPort
4	HDBaseT
5	SDI
6	VGA
7	Follow output
8	DGKat

18.4 Genlock Types

Number	Value
0	Free run
1	Digital
2	Analog

18.5 Video Port Type

Number	Value
0	Undefined
1	DVI
2	HDMI
3	DisplayPort
4	HDBaseT
5	SDI
6	VGA
7	DGKat

18.6 Video Resolutions

VIC Number	Resolution
0	No Signal (for input) / Native - EDID (for output)
1	640x480p @59.94Hz/60Hz
2	720x480p @59.94Hz/60Hz
3	720x480p @59.94Hz/60Hz
4	1280x720p @59.94Hz/60Hz
5	1920x1080i @59.94Hz/60Hz
6	720(1440)x480i @59.94Hz/60Hz
7	720(1440)x480i @59.94Hz/60Hz
8	720(1440)x240p @59.94Hz/60Hz
9	720(1440)x240p @59.94Hz/60Hz
10	2880x480i @59.94Hz/60Hz
11	2880x480i @59.94Hz/60Hz
12	2880x240p @59.94Hz/60Hz
13	2880x240p @59.94Hz/60Hz
14	1440x480p @59.94Hz/60Hz
15	1440x480p @59.94Hz/60Hz
16	1920x1080p @59.94Hz/60Hz
17	720x576p @50Hz
18	720x576p @50Hz
19	1280x720p @50Hz
20	1920x1080i @50Hz
21	720(1440)x576i @50Hz
22	720(1440)x576i @50Hz
23	720(1440)x288p @50Hz
24	720(1440)x288p @50Hz
25	2880x576i @50Hz
26	2880x576i @50Hz

VIC Number	Resolution
27	2880x288p @50Hz
28	2880x288p @50Hz
29	1440x576p @50Hz
30	1440x576p @50Hz
31	1920x1080p @50Hz
32	1920x1080p @23.97Hz/24Hz
33	1920x1080p @25Hz
34	1920x1080p @29.97Hz/30Hz
35	2880x480p @59.94Hz/60Hz
36	2880x480p @59.94Hz/60Hz
37	2880x576p @50Hz
38	2880x576p @50Hz
39	1920x1080i @50Hz
40	1920x1080i @100Hz
41	1280x720p @100Hz
42	720x576p @100Hz
43	720x576p @100Hz
44	720(1440)x576i @100Hz
45	720(1440)x576i @100Hz
46	1920x1080i @119.88/120Hz
47	1280x720p @119.88/120Hz
48	720x480p @119.88/120Hz
49	720x480p @119.88/120Hz
50	720(1440)x480i @119.88/120Hz
51	720(1440)x480i @119.88/120Hz
52	720x576p @200Hz
53	720x576p @200Hz
54	720(1440)x576i @200Hz
55	720(1440)x576i @200Hz
56	720x480p @239.76/240Hz
57	720x480p @239.76/240Hz
58	720(1440)x480i @239.76/240Hz
59	720(1440)x480i @239.76/240Hz
60	1280x720p @23.97Hz/24Hz
61	1280x720p @25Hz
62	1280x720p @29.97Hz/30Hz
63	1920x1080p @119.88/120Hz
64	1920x1080p @100Hz
65-100	(Reserved)
100	Custom resolution 1
101	Custom resolution 2
102	Custom resolution 3

VIC Number	Resolution
103	Custom resolution 4
104	Custom resolution 5
104-254	(Reserved)

18.7 Color Space

Number	Value
0	RGB
1	YCbCr 4:2:2
2	YCbCr 4:4:4

18.8 Image Properties

Number	Value
0	Overscan
1	Full
2	Best fit
3	Panscan
4	Letterbox
5	Underscan 2
6	Underscan 1

18.9 View Modes

Number	Value
0	PIP off (matrix)
1	PIP on (dual PIP)
2	Preview (not applicable)
3	Quad
4	Video wall
5	POP

18.10 Custom Resolution Parameters

Number	Value
0	Width
1	Height
2	HTotal
3	VTTotal
4	HSync width
5	HSync back porch
6	VSyn width
7	VSyn back porch
8	Frame rate
9	Interlaced (0)/Progressive (1)

18.11 Detail Timing Parameters

Number	Value
1	H-De-Start
2	H-De-Total
3	H-Total
4	V-De-Start
5	V-De-Total
6	Auto-DE-adjust
7	Auto-PHASE-adjust

18.12 Video/Audio Signal Changes

Number	Value
0	Video signal lost
1	New video signal detected
2	Audio signal lost
3	Audio signal detected
4	Disable 5V on video output if no input signal detected
5	Video cable unplugged
6	Audio cable unplugged

18.13 Font Size

Number	Value
0	Small
1	Medium
2	Large

18.14 Layer Enumeration

Number	Value
1	Video
2	Audio
3	Data

18.15 Software Programmed

Number	Value
0	Do nothing
1	Step-in out 1
2	Step-in out 2
...	...
128	Step-in out 128
129	Echo to controller

18.16 EDID Source

Number	Value
0	Input
1	Output
2	Default EDID

18.17 EDID Audio Capabilities

Number	Value
0	LPCM 2CH
1	LPCM 6CH
2	LPCM 8CH
3	Bitstream
4	HD

18.18 Signal Validation

Number	Value
0	Signal or sink is not valid
1	Signal or sink is valid
2	Sink and EDID is valid

18.19 Ethernet Port Types

Number	Value
0	TCP
1	UDP

18.20 HDCP Types

Number	Value
0	HDCP Off
1	HDCP On
2	Follow input
3	Mirror output ("MAC mode")

18.21 Parity Types

Number	Value
0	No
1	Odd
2	Even
3	Mark
4	Space

18.22 Serial Types

Number	Value
0	232
1	485

18.23 Audio Signal Types

Number	Value
0	No info
1	PCM
2	AC-3
3	MPEG1
4	MP3
5	MPEG2
6	AAC LC
7	DTS
8	ATRAC
9	DSD
10	E-AC-3
11	DTS-HD
12	MLP
13	DST
14	WMA Pro

18.24 Frequency Number

Number	Value
0	120
1	200
3	500
4	1200
5	3000
6	7500
8	12000

18.25 Audio Level

Number	Value
0	-10dB
20	0dB
40	+10dB

18.26 Audio Delay

Number	Value
0	Off
1	10ms
2	20ms
3	30ms
4	40ms
5	50ms
6	60ms
7	70ms
8	80ms
9	Auto

18.27 IR Transmit Status

Number	Value
0	IR sent
1	IR stop
2	IR busy
3	IR wrong parameter
4	IR nothing to stop

LIMITED WARRANTY

The warranty obligations of Kramer Electronics for this product are limited to the terms set forth below:

What is Covered

This limited warranty covers defects in materials and workmanship in this product.

What is Not Covered

This limited warranty does not cover any damage, deterioration or malfunction resulting from any alteration, modification, improper or unreasonable use or maintenance, misuse, abuse, accident, neglect, exposure to excess moisture, fire, improper packing and shipping (such claims must be presented to the carrier), lightning, power surges, or other acts of nature. This limited warranty does not cover any damage, deterioration or malfunction resulting from the installation or removal of this product from any installation, any unauthorized tampering with this product, any repairs attempted by anyone unauthorized by Kramer Electronics to make such repairs, or any other cause which does not relate directly to a defect in materials and/or workmanship of this product. This limited warranty does not cover cartons, equipment enclosures, cables or accessories used in conjunction with this product.

Without limiting any other exclusion herein, Kramer Electronics does not warrant that the product covered hereby, including, without limitation, the technology and/or integrated circuit(s) included in the product, will not become obsolete or that such items are or will remain compatible with any other product or technology with which the product may be used.

How Long Does this Coverage Last

Seven years as of this printing; please check our Web site for the most current and accurate warranty information.

Who is Covered

Only the original purchaser of this product is covered under this limited warranty. This limited warranty is not transferable to subsequent purchasers or owners of this product.

What Kramer Electronics will do

Kramer Electronics will, at its sole option, provide one of the following three remedies to whatever extent it shall deem necessary to satisfy a proper claim under this limited warranty:

1. Elect to repair or facilitate the repair of any defective parts within a reasonable period of time, free of any charge for the necessary parts and labor to complete the repair and restore this product to its proper operating condition. Kramer Electronics will also pay the shipping costs necessary to return this product once the repair is complete.
2. Replace this product with a direct replacement or with a similar product deemed by Kramer Electronics to perform substantially the same function as the original product.
3. Issue a refund of the original purchase price less depreciation to be determined based on the age of the product at the time remedy is sought under this limited warranty.

What Kramer Electronics will not do Under This Limited Warranty

If this product is returned to Kramer Electronics or the authorized dealer from which it was purchased or any other party authorized to repair Kramer Electronics products, this product must be insured during shipment, with the insurance and shipping charges prepaid by you. If this product is returned uninsured, you assume all risks of loss or damage during shipment. Kramer Electronics will not be responsible for any costs related to the removal or re-installation of this product from or into any installation. Kramer Electronics will not be responsible for any costs related to any setting up this product, any adjustment of user controls or any programming required for a specific installation of this product.

How to Obtain a Remedy under this Limited Warranty

To obtain a remedy under this limited warranty, you must contact either the authorized Kramer Electronics reseller from whom you purchased this product or the Kramer Electronics office nearest you. For a list of authorized Kramer Electronics resellers and/or Kramer Electronics authorized service providers, please visit our web site at www.kramerelectronics.com or contact the Kramer Electronics office nearest you.

In order to pursue any remedy under this limited warranty, you must possess an original, dated receipt as proof of purchase from an authorized Kramer Electronics reseller. If this product is returned under this limited warranty, a return authorization number, obtained from Kramer Electronics, will be required. You may also be directed to an authorized reseller or a person authorized by Kramer Electronics to repair the product.

If it is decided that this product should be returned directly to Kramer Electronics, this product should be properly packed, preferably in the original carton, for shipping. Cartons not bearing a return authorization number will be refused.

Limitation on Liability

THE MAXIMUM LIABILITY OF KRAMER ELECTRONICS UNDER THIS LIMITED WARRANTY SHALL NOT EXCEED THE ACTUAL PURCHASE PRICE PAID FOR THE PRODUCT. TO THE MAXIMUM EXTENT PERMITTED BY LAW, KRAMER ELECTRONICS IS NOT RESPONSIBLE FOR DIRECT, SPECIAL, INCIDENTAL OR CONSEQUENTIAL DAMAGES RESULTING FROM ANY BREACH OF WARRANTY OR CONDITION, OR UNDER ANY OTHER LEGAL THEORY. Some countries, districts or states do not allow the exclusion or limitation of relief, special, incidental, consequential or indirect damages, or the limitation of liability to specified amounts, so the above limitations or exclusions may not apply to you.

Exclusive Remedy

TO THE MAXIMUM EXTENT PERMITTED BY LAW, THIS LIMITED WARRANTY AND THE REMEDIES SET FORTH ABOVE ARE EXCLUSIVE AND IN LIEU OF ALL OTHER WARRANTIES, REMEDIES AND CONDITIONS, WHETHER ORAL OR WRITTEN, EXPRESS OR IMPLIED. TO THE MAXIMUM EXTENT PERMITTED BY LAW, KRAMER ELECTRONICS SPECIFICALLY DISCLAIMS ANY AND ALL IMPLIED WARRANTIES, INCLUDING, WITHOUT LIMITATION, WARRANTIES OF MERCHANTABILITY AND FITNESS FOR A PARTICULAR PURPOSE. IF KRAMER ELECTRONICS CANNOT LAWFULLY DISCLAIM OR EXCLUDE IMPLIED WARRANTIES UNDER APPLICABLE LAW, THEN ALL IMPLIED WARRANTIES COVERING THIS PRODUCT, INCLUDING WARRANTIES OF MERCHANTABILITY AND FITNESS FOR A PARTICULAR PURPOSE, SHALL APPLY TO THIS PRODUCT AS PROVIDED UNDER APPLICABLE LAW.

IF ANY PRODUCT TO WHICH THIS LIMITED WARRANTY APPLIES IS A "CONSUMER PRODUCT" UNDER THE MAGNUSON-MOSS WARRANTY ACT (15 U.S.C.A. §2301, ET SEQ.) OR OTHER APPLICABLE LAW, THE FOREGOING DISCLAIMER OF IMPLIED WARRANTIES SHALL NOT APPLY TO YOU, AND ALL IMPLIED WARRANTIES ON THIS PRODUCT, INCLUDING WARRANTIES OF MERCHANTABILITY AND FITNESS FOR THE PARTICULAR PURPOSE, SHALL APPLY AS PROVIDED UNDER APPLICABLE LAW.

Other Conditions

This limited warranty gives you specific legal rights, and you may have other rights which vary from country to country or state to state.

This limited warranty is void if (i) the label bearing the serial number of this product has been removed or defaced, (ii) the product is not distributed by Kramer Electronics or (iii) this product is not purchased from an authorized Kramer Electronics reseller. If you are unsure whether a reseller is an authorized Kramer Electronics reseller, please visit our Web site at www.kramerelectronics.com or contact a Kramer Electronics office from the list at the end of this document.

Your rights under this limited warranty are not diminished if you do not complete and return the product registration form or complete and submit the online product registration form. Kramer Electronics thanks you for purchasing a Kramer Electronics product. We hope it will give you years of satisfaction.



For the latest information on our products and a list of Kramer distributors, visit our Web site where updates to this user manual may be found.

We welcome your questions, comments, and feedback.

Web site: www.kramerelectronics.com

E-mail: info@kramere.com

CE



SAFETY WARNING

Disconnect the unit from the power supply before opening and servicing



P/N: 2900-300469



Rev: 1