

# 4K / UHD Five-Input HDMI Switcher with Two HDBaseT Inputs and Mirrored HDMI / HDBaseT Outputs



## Version Information

---

Version	Release Date	Notes
1	Dec 2020	New format
2	Sep 2021	IR remote no longer shipping with unit; IR documentation is still included for units in the field.

## Welcome to Atlona!

---

Thank you for purchasing this Atlona product. We hope you enjoy it and will take a extra few moments to register your new purchase.

Registration only takes a few minutes and protects this product against theft or loss. In addition, you will receive notifications of product updates and firmware. Atlona product registration is voluntary and failure to register will not affect the product warranty.

To register your product, go to <http://atlona.com/registration>

## Sales, Marketing, and Customer Support

---

### Main Office

Atlona Incorporated  
70 Daggett Drive  
San Jose, CA 95134  
United States

Office: +1.877.536.3976 (US Toll-free)  
Office: +1.408.962.0515 (US/International)

Sales and Customer Service Hours  
Monday - Friday: 6:00 a.m. - 4:30 p.m. (PST)

<http://atlona.com/>

### International Headquarters

Atlona International AG  
Tödistrasse 18  
8002 Zürich  
Switzerland

Office: +41.43.508.4321

Sales and Customer Service Hours  
Monday - Friday: 09:00 - 17:00 (UTC +1)

## Operating Notes

---



**IMPORTANT:** Visit <http://atlona.com/product/AT-UHD-SW-5000ED> for the latest firmware updates and User Manual.



**NOTE:** The AT-UHD-SW-5000ED no longer ships with an IR remote control. However, IR documentation remains for units currently in the field.

# Atlona, Inc. (“Atlona”) Limited Product Warranty

---

## Coverage

Atlona warrants its products will substantially perform to their published specifications and will be free from defects in materials and workmanship under normal use, conditions and service.

Under its Limited Product Warranty, Atlona, at its sole discretion, will either:

- repair or facilitate the repair of defective products within a reasonable period of time, restore products to their proper operating condition and return defective products free of any charge for necessary parts, labor and shipping.

OR

- replace and return, free of charge, any defective products with direct replacement or with similar products deemed by Atlona to perform substantially the same function as the original products.

OR

- refund the pro-rated value based on the remaining term of the warranty period, not to exceed MSRP, in cases where products are beyond repair and/or no direct or substantially similar replacement products exist.

Repair, replacement or refund of Atlona products is the purchaser’s exclusive remedy and Atlona liability does not extend to any other damages, incidental, consequential or otherwise.

This Limited Product Warranty extends to the original end-user purchaser of Atlona products and is non-transferrable to any subsequent purchaser(s) or owner(s) of these products.

## Coverage Periods

Atlona Limited Product Warranty Period begins on the date of purchase by the end-purchaser. The date contained on the end-purchaser’s sales or delivery receipt is the proof purchase date.

### Limited Product Warranty Terms – New Products

- 10 years from proof of purchase date for hardware/electronics products purchased on or after June 1, 2013.
- 3 years from proof of purchase date for hardware/electronics products purchased before June 1, 2013.
- Lifetime Limited Product Warranty for all cable products.

### Limited Product Warranty Terms – Refurbished (B-Stock) Products and Discontinued Products

- 3 years from proof of purchase date for all Refurbished (B-Stock) and Discontinued hardware and electronic products purchased on or after June 1, 2013.

## Remedy

Atlona recommends that end-purchasers contact their authorized Atlona dealer or reseller from whom they purchased their products. Atlona can also be contacted directly. Visit [atlona.com](http://atlona.com) for Atlona’s contact information and hours of operation. Atlona requires that a dated sales or delivery receipt from an authorized dealer, reseller or end-purchaser is provided before Atlona extends its warranty services. Additionally, a return merchandise authorization (RMA) and/or case number, is required to be obtained from Atlona in advance of returns.

Atlona requires that products returned are properly packed, preferably in the original carton, for shipping. Cartons not bearing a return authorization or case number will be refused. Atlona, at its sole discretion, reserves the right to reject any products received without advanced authorization. Authorizations can be requested by calling 1-877-536-3976 (US toll free) or 1-408- 962-0515 (US/international) or via Atlona’s website at [atlona.com](http://atlona.com).

## Exclusions

This Limited Product Warranty excludes:

- Damage, deterioration or malfunction caused by any alteration, modification, improper use, neglect, improper packaging or shipping (such claims must be presented to the carrier), lightning, power surges, or other acts of nature.

## Atlona, Inc. (“Atlona”) Limited Product Warranty

---

- Damage, deterioration or malfunction resulting from the installation or removal of this product from any installation, any unauthorized tampering with this product, any repairs attempted by anyone unauthorized by Atlona to make such repairs, or any other cause which does not relate directly to a defect in materials and/or workmanship of this product.
- Equipment enclosures, cables, power supplies, batteries, LCD displays, and any accessories used in conjunction with the product(s).
- Products purchased from unauthorized distributors, dealers, resellers, auction websites and similar unauthorized channels of distribution.

### Disclaimers

This Limited Product Warranty does not imply that the electronic components contained within Atlona’s products will not become obsolete nor does it imply Atlona products or their electronic components will remain compatible with any other current product, technology or any future products or technologies in which Atlona’s products may be used in conjunction with. Atlona, at its sole discretion, reserves the right not to extend its warranty offering in instances arising outside its normal course of business including, but not limited to, damage inflicted to its products from acts of god.

### Limitation on Liability

The maximum liability of Atlona under this limited product warranty shall not exceed the original Atlona MSRP for its products. To the maximum extent permitted by law, Atlona is not responsible for the direct, special, incidental or consequential damages resulting from any breach of warranty or condition, or under any other legal theory. Some countries, districts or states do not allow the exclusion or limitation of relief, special, incidental, consequential or indirect damages, or the limitation of liability to specified amounts, so the above limitations or exclusions may not apply to you.

### Exclusive Remedy

To the maximum extent permitted by law, this limited product warranty and the remedies set forth above are exclusive and in lieu of all other warranties, remedies and conditions, whether oral or written, express or implied. To the maximum extent permitted by law, Atlona specifically disclaims all implied warranties, including, without limitation, warranties of merchantability and fitness for a particular purpose. If Atlona cannot lawfully disclaim or exclude implied warranties under applicable law, then all implied warranties covering its products including warranties of merchantability and fitness for a particular purpose, shall provide to its products under applicable law. If any product to which this limited warranty applies is a “Consumer Product” under the Magnuson-Moss Warranty Act (15 U.S.C.A. §2301, ET SEQ.) or other applicable law, the foregoing disclaimer of implied warranties shall not apply, and all implied warranties on its products, including warranties of merchantability and fitness for the particular purpose, shall apply as provided under applicable law.

### Other Conditions

Atlona’s Limited Product Warranty offering gives legal rights, and other rights may apply and vary from country to country or state to state. This limited warranty is void if (i) the label bearing the serial number of products have been removed or defaced, (ii) products are not purchased from an authorized Atlona dealer or reseller. A comprehensive list of Atlona’s authorized distributors, dealers and resellers can be found at [atlona.com](http://atlona.com).

## Safety and Certification



CAUTION: TO REDUCE THE RISK OF ELECTRIC SHOCK DO NOT OPEN ENCLOSURE OR EXPOSE TO RAIN OR MOISTURE. NO USER-SERVICEABLE PARTS INSIDE REFER SERVICING TO QUALIFIED SERVICE PERSONNEL.



The exclamation point within an equilateral triangle is intended to alert the user to the presence of important operating and maintenance instructions in the literature accompanying the product.



The information bubble is intended to alert the user to helpful or optional operational instructions in the literature accompanying the product.

1. Read these instructions.
2. Keep these instructions.
3. Heed all warnings.
4. Follow all instructions.
5. Do not use this product near water.
6. Clean only with a dry cloth.
7. Do not block any ventilation openings. Install in accordance with the manufacturer's instructions.
8. Do not install or place this product near any heat sources such as radiators, heat registers, stoves, or other apparatus (including amplifiers) that produce heat.
9. Do not defeat the safety purpose of a polarized or grounding-type plug. A polarized plug has two blades with one wider than the other. A grounding type plug has two blades and a third grounding prong. The wide blade or the third prong are provided for your safety. If the provided plug does not fit into your outlet, consult an electrician for replacement of the obsolete outlet.
10. Protect the power cord from being walked on or pinched particularly at plugs, convenience receptacles, and the point where they exit from the product.
11. Only use attachments/accessories specified by Atlona.
12. To reduce the risk of electric shock and/or damage to this product, never handle or touch this unit or power cord if your hands are wet or damp. Do not expose this product to rain or moisture.
13. Unplug this product during lightning storms or when unused for long periods of time.
14. Refer all servicing to qualified service personnel. Servicing is required when the product has been damaged in any way, such as power-supply cord or plug is damaged, liquid has been spilled or objects have fallen into the product, the product has been exposed to rain or moisture, does not operate normally, or has been dropped.



## FCC Compliance

FCC Compliance and Advisory Statement: This hardware device complies with Part 15 of the FCC rules. Operation is subject to the following two conditions: 1) this device may not cause harmful interference, and 2) this device must accept any interference received including interference that may cause undesired operation. This equipment has been tested and found to comply with the limits for a Class A digital device, pursuant to Part 15 of the FCC Rules. These limits are designed to provide reasonable protection against harmful interference in a commercial installation. This equipment generates, uses, and can radiate radio frequency energy and, if not installed or used in accordance with the instructions, may cause harmful interference to radio communications. However there is no guarantee that interference will not occur in a particular installation. If this equipment does cause harmful interference to radio or television reception, which can be determined by turning the equipment off and on, the user is encouraged to try to correct the interference by one or more of the following measures: 1) reorient or relocate the receiving antenna; 2) increase the separation between the equipment and the receiver; 3) connect the equipment to an outlet on a circuit different from that to which the receiver is connected; 4) consult the dealer or an experienced radio/TV technician for help. Any changes or modifications not expressly approved by the party responsible for compliance could void the user's authority to operate the equipment. Where shielded interface cables have been provided with the product or specified additional components or accessories elsewhere defined to be used with the installation of the product, they must be used in order to ensure compliance with FCC regulations.

## Copyright, Trademark, and Registration

© 2021 Atlona Inc. All rights reserved. "Atlona" and the Atlona logo are registered trademarks of Atlona Inc. Pricing, specifications and availability subject to change without notice. Actual products, product images, and online product images may vary from images shown here.

**HDMI**™ The terms HDMI, HDMI High-Definition Multimedia Interface, and the HDMI Logo are trademarks or registered trademarks of HDMI licensing Administrator, Inc.

Dolby, Dolby Atmos, and the double-D symbol are registered trademarks of Dolby Laboratories Licensing Corporation.

For DTS patents, see <http://patents.dts.com>. Manufactured under license from DTS, Inc. DTS, the Symbol, DTS and the Symbol together, and Digital Surround are registered trademarks and/or trademarks of DTS, Inc. in the United States and/or other countries. © DTS, Inc. All Rights Reserved.

All other trademark(s), copyright(s), and registered technologies mentioned(s) in this document are the properties of their respective owner(s).

# Table of Contents

---

<b>Introduction</b>	<b>9</b>
<b>Features</b>	<b>9</b>
<b>Package Contents</b>	<b>9</b>
<b>Panel Description</b>	<b>10</b>
Front Panel	10
Rear Panel	11
<b>Installation</b>	<b>12</b>
Power	12
Audio	12
RS-232	13
Connection Instructions	14
Connection Diagram	15
IP Configuration	16
Setting the IP Address using the Web Server	16
Auto IP (APIPA) Mode	16
<b>Device Operation</b>	<b>17</b>
LED Indicators	17
System Configuration	18
Getting the MAC Address	18
Changing the Network IP Mode	19
Setting Static IP Mode using the Front Panel	20
Changing the Telnet Port	21
Telnet Login Mode	22
Setting the Host Name	23
Video Switching	24
Enabling / Disabling Auto-Switching	24
Selecting the Input	25
Resetting to Factory-Defaults	26
Using the Web Server	26
Using the Front Panel	27
Audio Management	28
Adjusting Output Volume	28
Audio Output Muting	29
User Management	30
Changing the Administrator Password	30
Adding Users	31
Editing / Deleting Users	32
EDID Management	33
EDID Presets	33
Storing EDID Data	35
HDCP Content	37
<b>Configuration and Management Interfaces</b>	<b>38</b>
Introduction to the Web Server	38
Home Page	39
Network Setup Page	40
Settings Page	41
Config Page	42
EDID Page	44
Control Page	46
HDVS Page	49
Update Page	50
HDBT Page	51

<b>Appendix</b>	<b>52</b>
Updating the Firmware	52
Using the Web Server	52
Using the USB Interface	53
HDBaseT Testing	55
Mounting Instructions	56
Single Unit Rack Installation	56
Dual Unit Rack Installation	57
Flat Surface	58
IR Remote Control	59
Specifications	60



## Introduction

---

The Atlona **AT-UHD-SW-5000ED** is a 5x1 switcher with two HDBaseT™ inputs, three HDMI inputs, mirrored HDMI and HDBaseT outputs, balanced audio outputs, automatic input selection, and advanced display control capability. The HDBaseT inputs match perfectly with the HDVS-200-TX modules to enable VGA and HDMI sources to be easily integrated into a system. The switcher supports 4K/UHD @ 60 Hz, 4:2:0; (10.2 Gbps). It transmits AV signals along with Ethernet, power, and control over a single cable to displays up to 328 feet (100 meters) from the switcher. Control options include automatic input selection, front-panel buttons, and compatibility with IR, RS-232, or TCP/IP-based control systems. Displays are automatically turned on and off using CEC, IP, or RS-232. Advanced features also include a web-based GUI for easy set-up and management of EDID, HDCP, and display control. The switcher offers audio de-embedding of PCM audio over HDMI to two-channel, balanced +4 dBu analog audio outputs. The switcher is a cost-effective product for professional integration featuring a compact, 1U, half-rack width enclosure that is easily installed with included 19" rack-mount brackets. Two units can be mounted side-by-side.

The **AT-UHD-SW-5000ED** enables two HDVS transmitters to be used in a single system. With Ethernet enabled HDBaseT transmission to the HDVS transmitters and the receiver control, setup and maintenance is simplified. Automatic input selection and display control simplify the system, reducing cost, reducing setup time and resulting in a better end user experience.

## Features

---

- Two, Ethernet-enabled HDBaseT Inputs
- Mirrored, dual outputs on HDMI and HDBaseT
- Automatic display control
- Automatic input selection using hot plug detect and video detection technology
- Ethernet-enabled HDBaseT
- EDID management and HDCP management
- 4K/UHD capability
- AV, Ethernet, power and control over HDBaseT
- TCP/IP, RS-232, and IR control
- Easy, GUI-based configuration using integrated web server
- Volume controls
- Volume setting indicator
- Balanced, line level output
- Multi-channel audio compliant
- Rack-mountable, 1U, half rack width enclosure
- Works with Velocity with Integrated AMS

## Package Contents

---

- 1 x AT-UHD-SW-5000ED
- 2 x 5-pin captive screw connectors
- 1 x 3-pin captive screw connector
- 1 x 2-pin captive screw connector
- 1 x Rack ears set, 1-long, 1 short, 2 table mount
- 4 x Rack ears screws
- 1 x 48 V / 0.83 A DC power supply
- 1 x power cord

## Panel Description

### Front Panel

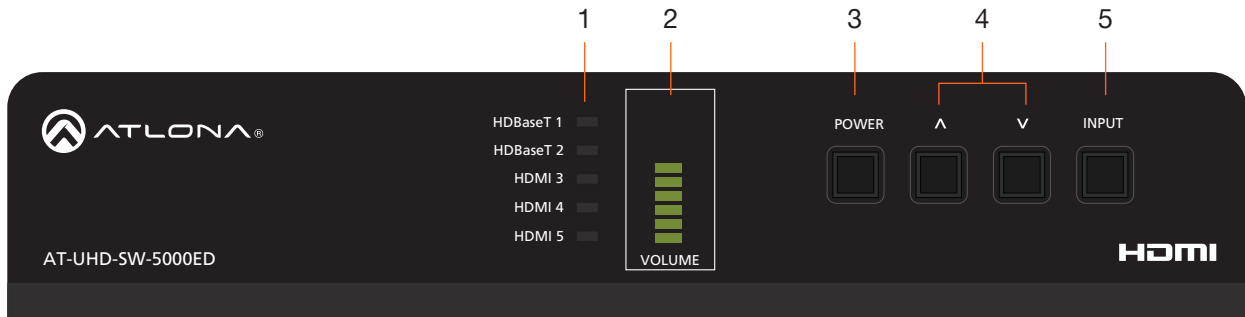

#### 1 Input LED Indicators

These LED indicators display which input is routed to the **HDMI OUT** port. A solid blue indicator represents the active input being used

#### 2 VOLUME

Displays the output audio level. Refer to [LED Indicators \(page 17\)](#) for more information.

#### 3 POWER

Press this button to toggle between “on” and “standby” power states. When in “standby”, A/V is muted. When “on”, A/V muting will be disabled.

#### 4 Cursor Buttons

Press and release these buttons to increase or decrease the audio output volume on the **ANALOG OUT** port.

#### 5 INPUT

Press and release this button to cycle through each of the inputs.

## Rear Panel

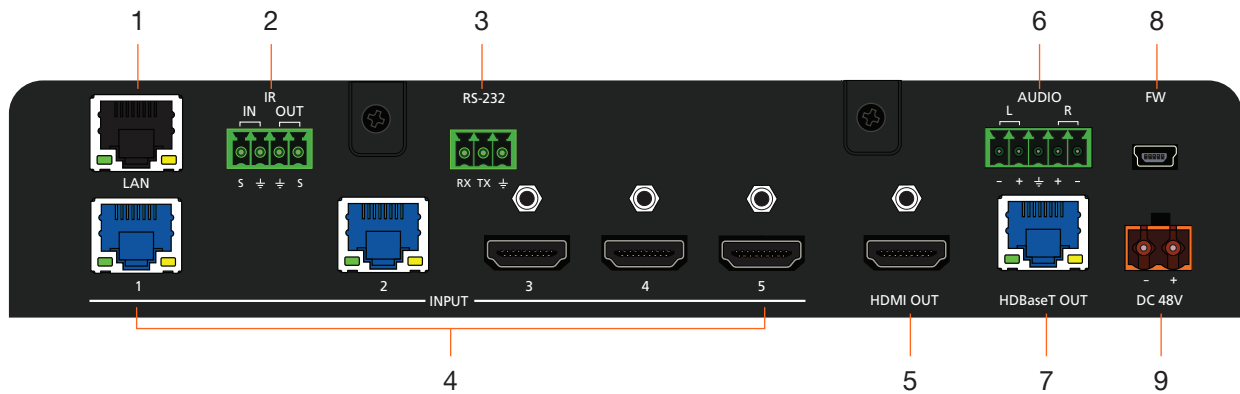

- 1 LAN**  
Connect an Ethernet cable from this port to the Local Area Network (LAN). The AT-UHD-SW-5000ED includes a built-in web server, which can be used to manage and configure the product.
- 2 IR IN/OUT**  
Connect the included 4-pin captive screw block to this port.
- 3 RS-232**  
Connect the included 3-pin captive screw block to an RS-232 controller to control the AT-UHD-SW-5000ED.
- 4 INPUT**  
Connect an category cable (CAT-5e or better) from **INPUT 1** and **INPUT 2** to HDBaseT transmitters. Connect an HDMI cable from **INPUT 3**, **INPUT 4**, and **INPUT 5** to UHD/HD HDMI sources.
- 5 HDMI OUT**  
Connect an HDMI cable from this port to an HD/UHD display.
- 6 AUDIO**  
Connect an audio output device to this port using the included captive screw block. Refer to [Audio \(page 12\)](#) for information on wiring.
- 7 HDBaseT OUT**  
Connect a category cable from this port to a the HDBaseT IN port of a compatible receiver unit.
- 8 FW**  
Connect a USB-to-mini USB cable to this port from a computer for firmware updates.
- 9 DC 48V**  
Connect the included 48 V DC power supply from this power receptacle to an available AC electrical outlet. Refer to [Power \(page 12\)](#) for more information on wiring the included captive screw connector.

# Installation

## Power

Connect the included 2-pin captive screw connector to the **DC 48V** power receptacle on the rear of the unit. Insert the positive and negative leads, from the power supply, into the terminals of the 2-pin captive screw connector block, as shown.

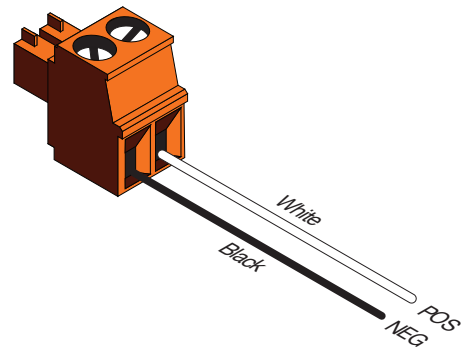
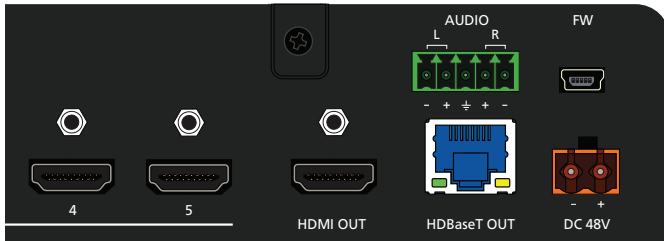

## Audio

The **AUDIO OUT** connector on the AT-UHD-SW-5000ED provides a separate output for balanced audio. Connect the included 5-pin captive-screw terminal block to the **AUDIO OUT** port. Balanced audio connections use two signal wires and a ground to minimize interference in audio signals. Unbalanced output audio is not supported.

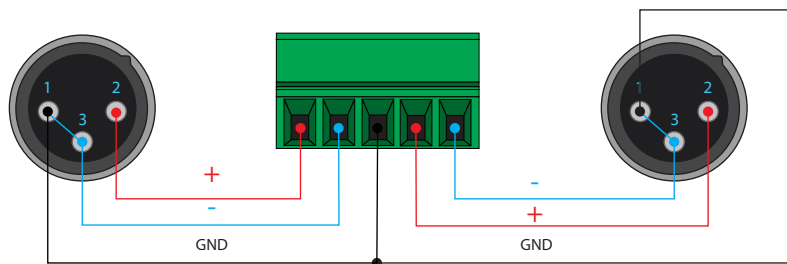
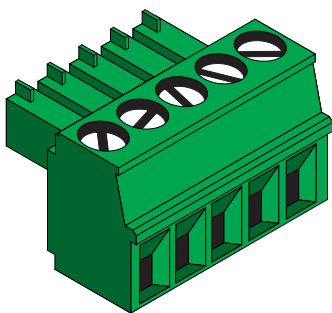

## RS-232

The AT-UHD-SW-5000ED provides an **RS-232** port which can be used to control a display connected to an HDMI output. Atlona recommends controlling the AT-UHD-SW-5000ED using IP and reserving the **RS-232** port for local display control.

1. Use wire strippers to remove a portion of the cable jacket.
2. Remove at least 3/16" (5 mm) of insulation from each of the wires.
3. Insert the wires into correct terminal using the included 3-pin captive screw connector.
4. Attach the 3-pin connector block to the **RS-232** port on the AT-UHD-SW-5000ED.

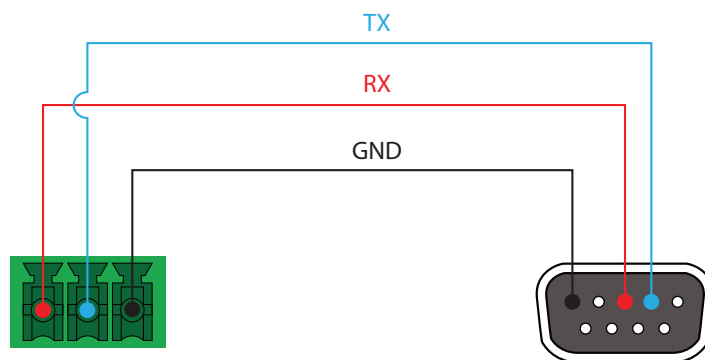
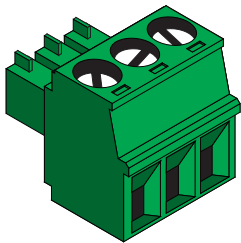

## Connection Instructions

1. Connect up to two HDBaseT transmitters to INPUT 1 and INPUT 2. Atlona recommends CAT-5e or better cabling.
2. Connect up to five UHD/HD HDMI sources to ports **INPUT 3** through **INPUT 5**.
3. Connect an HDMI cable from the **HDMI OUT** port to a UHD/HD display.
4. Connect a category cable (CAT-5e or better) from the **HDBaseT OUT** port to a compatible receiver.

Refer to the tables below for recommended cabling when using Atlona products with HDBaseT technology. The green bars indicate the signal quality when using each type of cable. Higher-quality signals are represented by more bars. *These tables are for guidance, only. Performance may vary, based on environmental factors.*

Core	Shielding	CAT5e	CAT6	CAT6a	CAT7
Solid	UTP (unshielded)	■	■■■	■■■■	N/A
	STP (sheilded)	■■	■■■■	■■■■■	■■■■■

Cable	Max. Distance @ 4K	Max. Distance @ 1080p
CAT5e	295 feet (90 meters)	330 feet (100 meters)
CAT6a / CAT6a / CAT7	330 feet (100 meters)	330 feet (100 meters)



**IMPORTANT:** Stranded or patch cable is not recommended due to performance issues. Shielded cables are strongly recommended to minimize signal noise and interference.

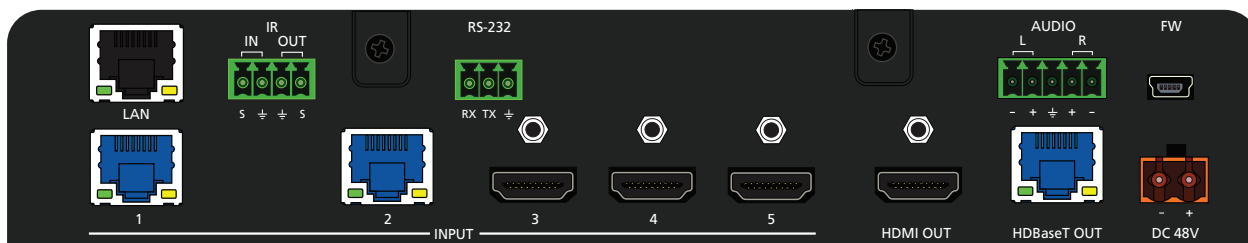

5. Connect an Ethernet cable from the **LAN** port to the Local Area Network (LAN).
6. OPTIONAL: Connect the included 5-pin captive screw connector to the **AUDIO OUT** port.
7. OPTIONAL: Connect the included 4-pin captive screw connector to the **IR IN/OUT** port.
8. OPTIONAL: Connect the included 3-pin captive screw block to the **RS-232** port.
9. Connect the included power supply to the **DC 48V** connector and connect the power cord to an available electrical outlet. Refer to [Power \(page 12\)](#) for more information.

### Connection Diagram

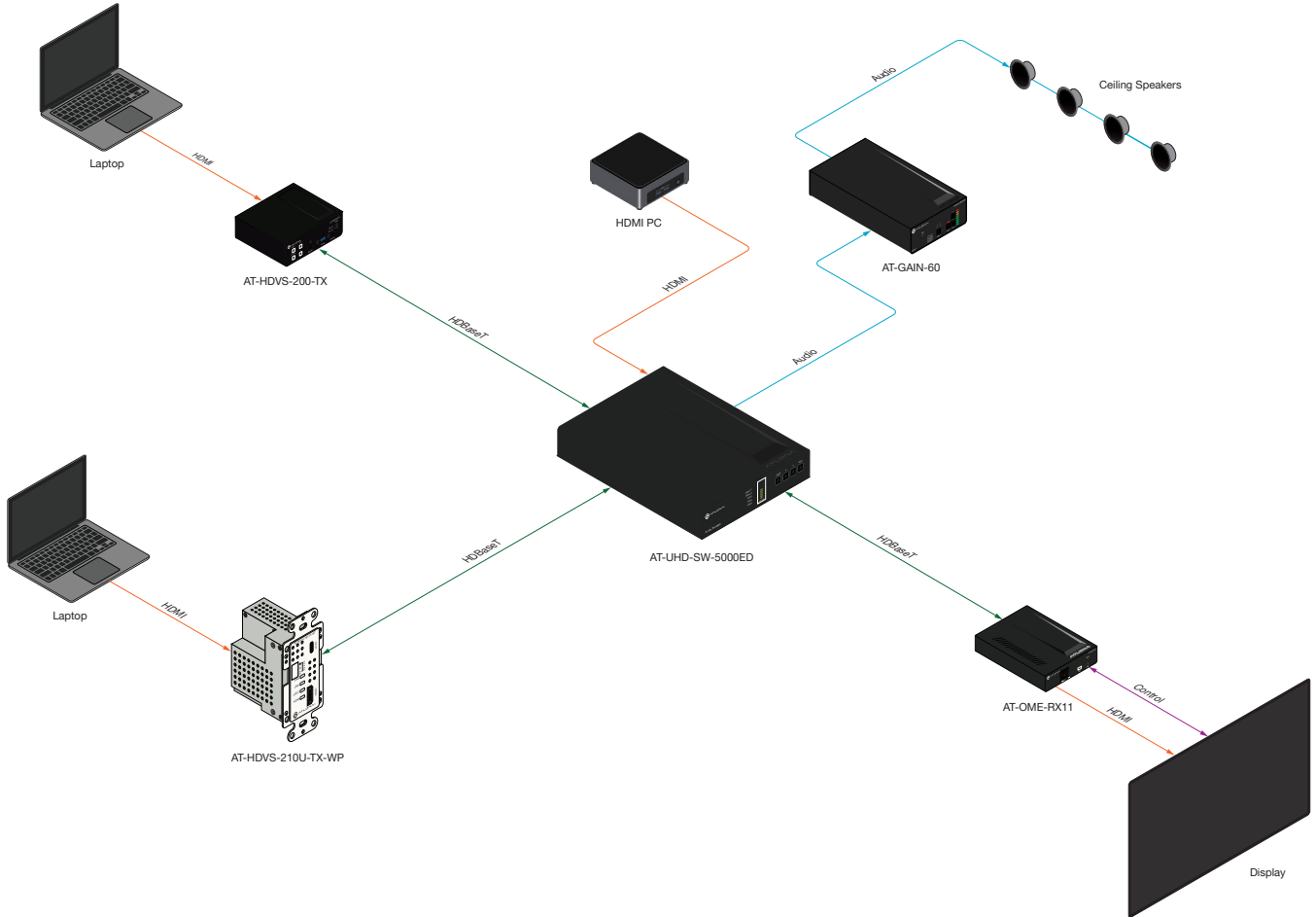

## IP Configuration

The AT-UHD-SW-5000ED is shipped with DHCP enabled. Once connected to a network, the DHCP server (if available), will automatically assign an IP address to the unit. If the AT-UHD-SW-5000ED is unable to detect a DHCP server within 15 seconds, then the unit will use a self-assigned IP address within the range of 169.254.xxx.xxx.

Use an IP scanner, along with the MAC address on the bottom of the unit, to identify the unit on the network. If a static IP address is desired, the unit can be switched to static IP mode. The default static IP address is 192.168.1.254.

### Setting the IP Address using the Web Server

The AT-UHD-SW-5000ED can be set to either DHCP or static IP mode. If changing the IP mode through the built-in web server, the IP address of the AT-UHD-SW-5000ED must be known. By default, the AT-UHD-SW-5000ED is set to DHCP mode and will automatically be assigned an IP address by a DHCP server. Refer to the [Changing the Network IP Mode \(page 19\)](#) for more information.

### Auto IP (APIPA) Mode

If the AT-UHD-SW-5000ED is unable to detect a DHCP server within 15 seconds, then the unit will use a self-assigned IP address within the range of 169.254.xxx.xxx. If this occurs, connect the AT-UHD-SW-5000ED to a computer running Microsoft Windows® and follow the procedure below.

1. Click **Start > Settings > Control Panel > Network and Sharing Center**.
2. Click **Change adapter settings**.
3. Right-click on the adapter that is used to establish a wired connection to the network, and select **Properties** from the context menu.
4. Under the **Ethernet Properties** dialog box, select **Internet Protocol Version 4** and then click the **Properties** button.
5. Click the **Use the following IP address** radio button.



**IMPORTANT:** Before continuing, write down the current IP settings in order to restore them, later. If **Obtain an IP address automatically** and **Obtain DNS server automatically** are selected, then this step is not required.









6. Enter the desired static IP address or the IP address provided by the network administrator. If the PC does not require Internet access or if a statically-assigned IP address is being used, then an IP address of 169.254.xxx.xxx can be entered.
7. Set the subnet mask to 255.255.0.0.
8. Click the **OK** button then close all **Control Panel** windows.



## Device Operation

### LED Indicators

The LED indicators on both the front and rear of the unit provide basic information on the current status of the AT-UHD-SW-5000ED.

LED	Description	
HDBaseT 1, HDBaseT 2, HDMI 3 - HDMI 5	Solid green 	The input is the currently selected (active) input.
	Off 	The input is not the active input.
VOLUME	Solid green 	Acceptable range for output volume.
	Solid amber 	Output volume level is approaching audio clipping.
	Solid red 	Audio clipping.
POWER	Solid blue 	Unit is powered and in normal operating mode. A/V muting is disabled.
	Solid red 	Unit is powered and in standby mode. In this mode, A/V will be muted. <ul style="list-style-type: none"> <li>Press the <b>POWER</b> button to place the unit in normal operating mode.</li> </ul>
	Off 	Unit is not powered. <ul style="list-style-type: none"> <li>Check the power supply and make sure it is securely fastened to the captive screw connector on the rear of the unit.</li> <li>Make sure that the power supply is connected to an available electrical outlet and that the outlet is “live” (some outlets are controlled by a wall switch).</li> </ul>

## System Configuration

The AT-UHD-SW-5000ED provides easy access to system configuration through the built-in web server, and is the recommended method to adjust network settings.

**NOTE:** When a setting within the **Network Settings** page is being modified, the background color will switch from white to gray. This indicates that a setting is being changed.

### Getting the MAC Address

1. Login to the web server. Refer to [Introduction to the Web Server \(page 38\)](#). The default username and password are listed below:

Username: root  
Password: Atlona

2. Click **Network Setup** in the menu bar.
3. Locate the MAC address field, as shown below. This is the hardware address of the AT-UHD-SW-5000ED.



The screenshot shows the AT-UHD-SW-5000ED Setup web interface. The 'Network Setup' page is displayed with various configuration fields. The MAC Address field is highlighted with a red box and labeled 'MAC address'. The MAC Address is shown as B8-98-B0-00-2A-CB. The Hostname is SW5000ED-002ACB. The Login Mode is ON. The background color of the MAC Address field is gray, indicating it is being modified.

Setting	Value
DHCP	<input checked="" type="checkbox"/> ON <input type="checkbox"/> OFF
IP Address	010.020.040.086
Subnet	255.255.255.000
Gateway	010.020.040.001
Telnet Port	23
Hostname	SW5000ED-002ACB
Login Mode	<input checked="" type="checkbox"/> ON <input type="checkbox"/> OFF
MAC Address	B8-98-B0-00-2A-CB

### Changing the Network IP Mode

By default, the AT-UHD-SW-5000ED is set to DHCP mode. Once connected to a network, and if a DHCP server is found (or available), the AT-UHD-SW-5000ED will be assigned an IP address on the network, and no further network configuration is required. However, if the AT-UHD-SW-5000ED is unable to detect a DHCP server within 15 seconds, then the unit will use a self-assigned IP address within the range of 169.254.xxx.xxx. The instructions below will focus on setting the AT-UHD-SW-5000ED to static IP mode.



**IMPORTANT:** Before assigning a static IP address to the AT-UHD-SW-5000ED, it is recommended to consult with the network or system administrator and obtain a available IP address. If the AT-UHD-SW-5000ED is assigned an IP address which is already in use by another device, it may cause either network issues and/or the AT-UHD-SW-5000ED will be not accessible.

1. Login to the web server. Refer to [Introduction to the Web Server \(page 38\)](#). The default username and password are listed below:

Username: root  
Password: Atlona

2. Click **Network Setup** in the menu bar.
3. Locate the **DHCP** section at the top of the page. The default setting is **ON**.
4. Click the **OFF** button to set the AT-UHD-SW-5000ED to static IP mode.
5. Enter the desired IP address for the AT-UHD-SW-5000ED in the **IP Address** field.
6. Enter the subnet mask and gateway address in the **Subnet** and **Gateway** fields, respectively.

DHCP	<u>ON</u>	<b>OFF</b> 
IP Address	<input type="text" value="010.020.040.086"/>	
Subnet	<input type="text" value="255.255.255.000"/>	
Gateway	<input type="text" value="010.020.040.001"/>	

7. Click **Save Setting** to commit changes. Click **Cancel** to abort changes. Changes will take effect immediately.

### Setting Static IP Mode using the Front Panel

By default, the AT-UHD-SW-5000ED is set to DHCP mode. Once connected to a network, and if a DHCP server is found (or available), the AT-UHD-SW-5000ED will be assigned an IP address on the network, and no further network configuration is required. However, in some cases, a static IP assignment may be desired. This procedure can be done through the web server (see previous page) or by using the front-panel buttons, as shown below.

1. Verify that the AT-UHD-SW-5000ED is powered.
2. Press and hold the **INPUT** button for 15 seconds, then release the button.

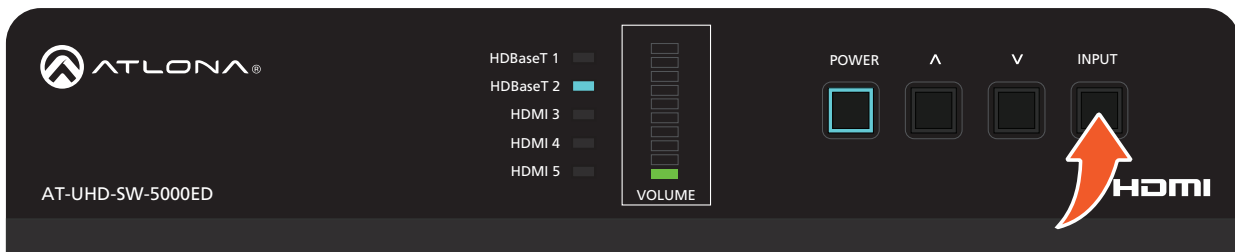

3. The **POWER** button will flash four times to indicate that the AT-UHD-SW-5000ED is in static IP mode. The following IP settings are assigned, automatically:

IP Address: 192.168.1.254  
Subnet: 255.255.0.0  
Gateway: 192.168.1.1

### Changing the Telnet Port

Typically, the Telnet service is assigned to TCP port 23. This is the default setting for the AT-UHD-SW-5000ED. However, depending upon the network environment, the default Telnet port can be changed.

1. Login to the web server. Refer to [Introduction to the Web Server \(page 38\)](#). The default username and password are listed below:

Username: root  
Password: Atlona

2. Click **Network Setup** in the menu bar.
3. Locate the **Telnet Port** field and enter the desired port in the field.

Gateway	010.020.040.001
Telnet Port	23
Hostname	SW5000ED-002ACB

4. Click **Save Settings** to commit changes. Click **Cancel** to abort changes.

### Telnet Login Mode

When a Telnet session is requested, the AT-UHD-SW-5000ED provides the option to prompt for user credentials or bypass authentication before the Telnet session begins. Prompting for credentials can be enabled or disabled. When prompting for user credentials, use the same login information required by the built-in web server.

1. Login to the web server. Refer to [Introduction to the Web Server \(page 38\)](#). The default username and password are listed below:

Username: root  
Password: Atlona

2. Click **Network Settings** in the menu bar.
3. Click the **Login Mode** button to **ON** or **OFF**.
  - Set this button to **ON** to prompt for user credentials.
  - Set this button to **OFF** to bypass user credentials request.

Gateway	010.020.040.001
Telnet Port	23
Hostname	SW5000ED-002ACB
Login Mode	<input type="radio"/> ON <input checked="" type="radio"/> OFF
MAC Address	B8-98-B0-00-2A-CB

4. Click **Save Setting** to commit changes. Click **Cancel** to abort changes.

### Setting the Host Name

By default, the AT-UHD-SW-5000ED is assigned a hostname, which is constructed as follows:

SW52ED-[last six digits of MAC address]

For example, a default hostname might look like this: SW52ED-006154. This value can be changed to easily identify the AT-UHD-SW-5000ED within the Atlona Management System (AMS) or a network. If using a custom hostname, it must meet the hostname standards defined here: <https://tools.ietf.org/html/rfc1123>

1. Login to the web server. Refer to [Introduction to the Web Server \(page 38\)](#). The default username and password are listed below:

Username: root  
Password: Atlona

2. Click **Network Settings** in the menu bar.
3. Click the **Hostname** field and enter the desired name.

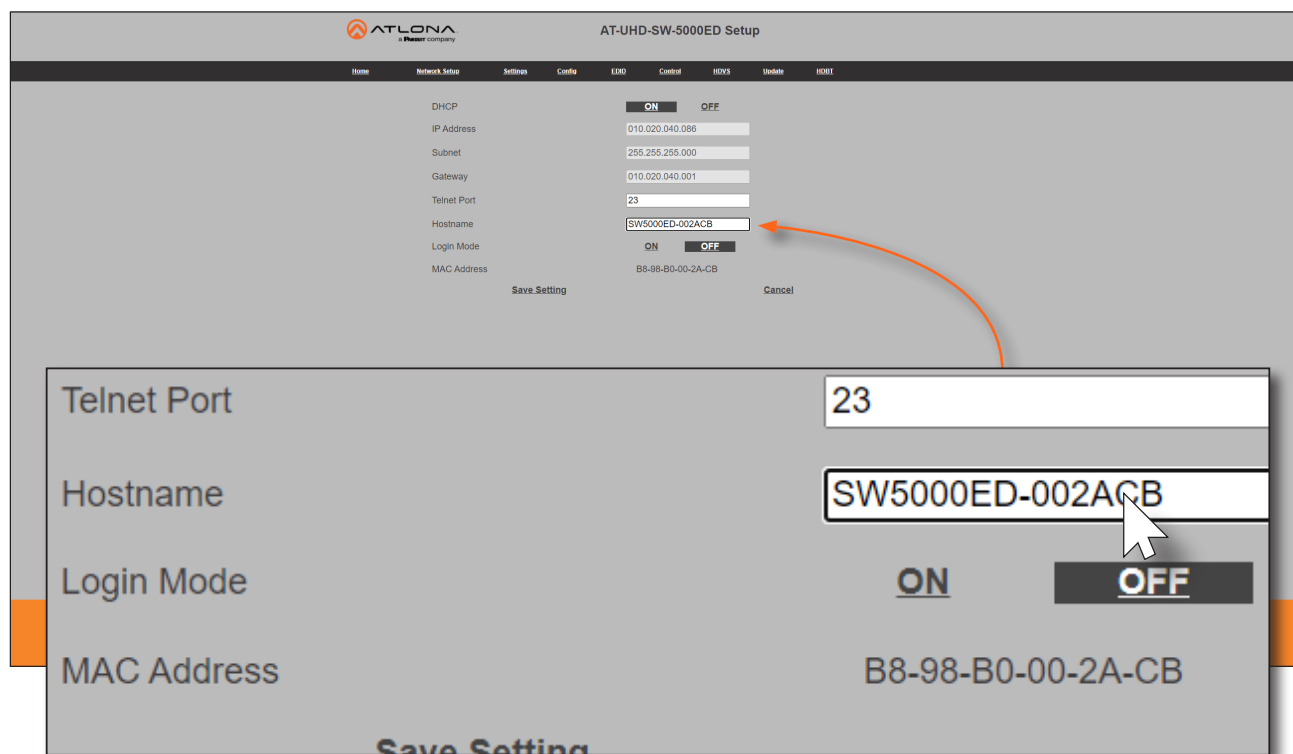

The screenshot displays the AT-UHD-SW-5000ED Setup web interface. The 'Network Setup' tab is active, showing various configuration options. The 'Hostname' field is highlighted with a red arrow and a mouse cursor, indicating it is the focus of the current step. The hostname is currently set to 'SW5000ED-002ACB'. Other visible settings include 'Telnet Port' set to 23, 'Login Mode' set to OFF, and 'MAC Address' set to B8-98-B0-00-2A-CB. The 'Save Setting' button is visible at the bottom of the form.

4. Click **Save Setting** to commit changes. Click **Cancel** to abort changes.

## Video Switching

### Enabling / Disabling Auto-Switching

The AT-UHD-SW-5000ED provides auto-switching capability, which is enabled by default. This feature will automatically switch the input to the most recently-connected source. If a source is disconnected, then the input will automatically be switched to the previously-connected source.

By default, auto-switching is enabled on the AT-UHD-SW-5000ED, allowing the unit to automatically switch between inputs when sources are connected or disconnected.

1. Login to the web server. Refer to [Introduction to the Web Server \(page 38\)](#). The default username and password are listed below:

Username: root  
Password: Atlona

2. Click **Settings** in the menu bar.
3. Click the **Auto Switch** drop-down list and select **On** to enable auto-switching. Auto-switching is disabled by default. If auto-switching is not desired, select **Off** from the drop-down list.



**NOTE:** The AT-UHD-SW-5000ED retains the currently selected input, even after the unit is powered-off then powered-on.

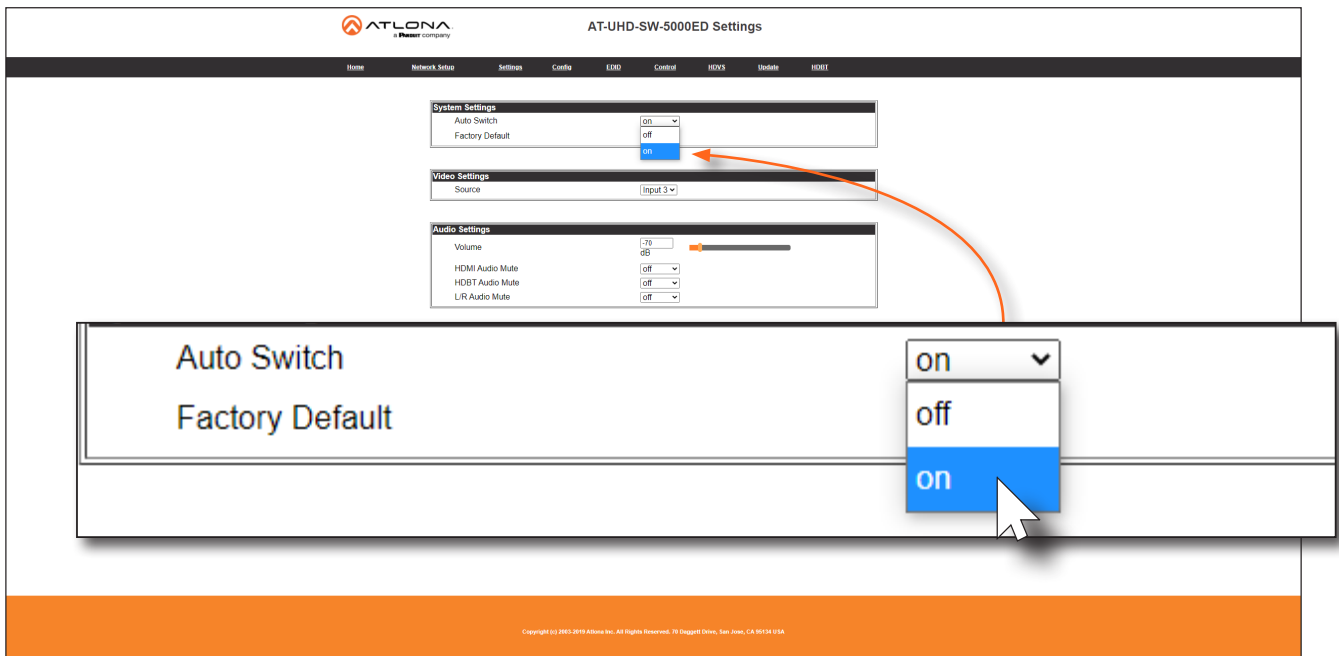

The screenshot shows the AT-UHD-SW-5000ED Settings page. The 'System Settings' section includes 'Auto Switch' (set to 'on') and 'Factory Default' (set to 'on'). The 'Video Settings' section includes 'Source' (set to 'Input 3'). The 'Audio Settings' section includes 'Volume' (set to -70 dB), 'HDMI Audio Mute' (set to 'off'), 'HDBT Audio Mute' (set to 'off'), and 'LR Audio Mute' (set to 'off'). A callout box highlights the 'Auto Switch' dropdown menu, which is open and shows 'on' selected. An orange arrow points from the 'on' option in the dropdown to the 'on' option in the 'Auto Switch' dropdown menu.

4. Auto-switching configuration is complete.



## Selecting the Input

The active input can be selected from the front panel, the built-in web server, or an API call. Refer to the AT-UHD-SW-5000ED Application Programming Interface for more information.

1. Login to the web server. Refer to [Introduction to the Web Server \(page 38\)](#). The default username and password are listed below:

Username: root  
 Password: Atlona

2. Click **Settings** in the menu bar.
3. Click the **Auto Switch** drop-down list and select **On** to enable auto-switching. Auto-switching is disabled by default. If auto-switching is not desired, select **Off** from the drop-down list.

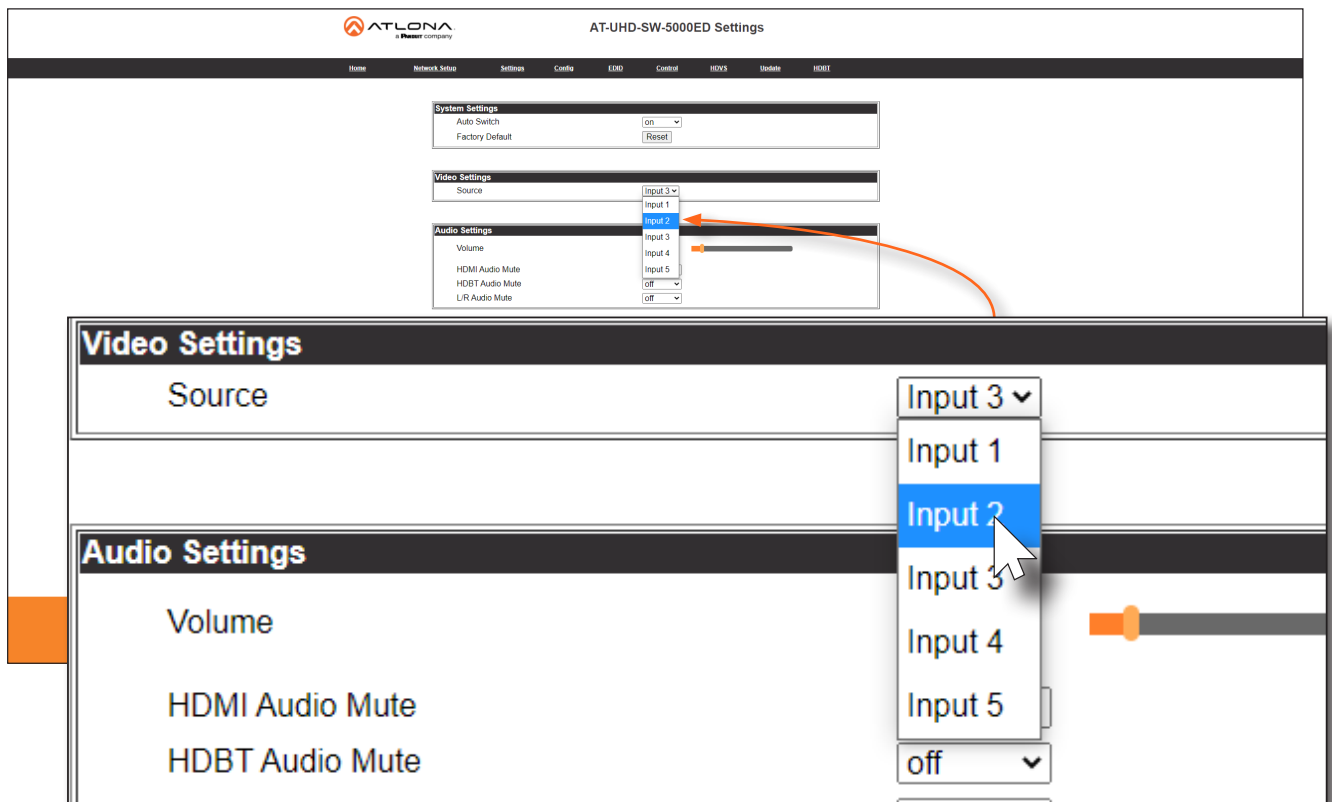

4. Selection of the active input is complete.
5. To select the input using the front panel buttons, press and release the **INPUT** button to cycle through each of the available inputs on the unit.

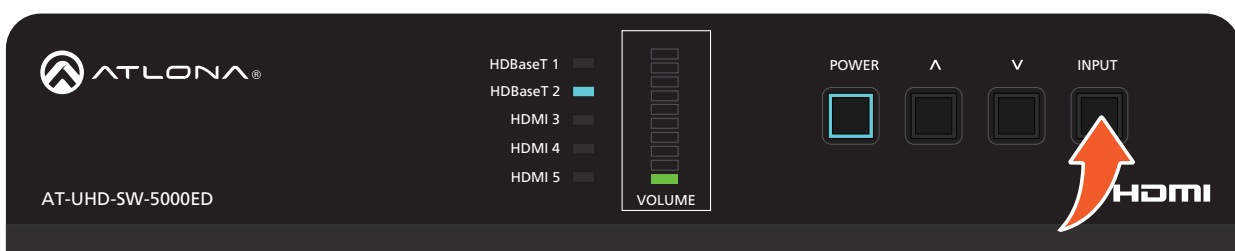

## Resetting to Factory-Defaults

The following procedure will reset the AT-UHD-SW-5000ED to factory-default settings. The network IP mode will be set to DHCP mode.

### Using the Web Server

1. Login to the web server. Refer to [Introduction to the Web Server \(page 38\)](#). The default username and password are listed below:

Username: root  
Password: Atlona

2. Click **Settings** in the menu bar.
3. Click the **Reset** button, next to **Factory Default**.

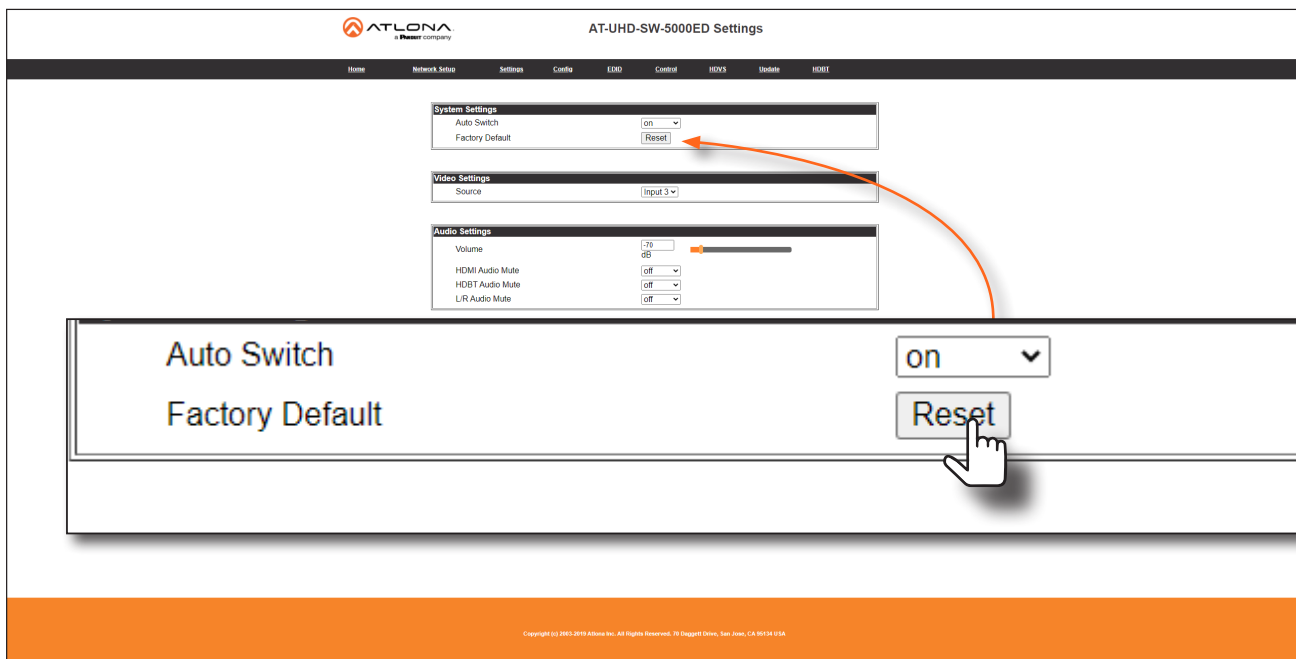

4. The following message will be displayed at the top of the screen. Click **OK** to continue with the factory-default reset procedure. Click **Cancel** to abort the process.

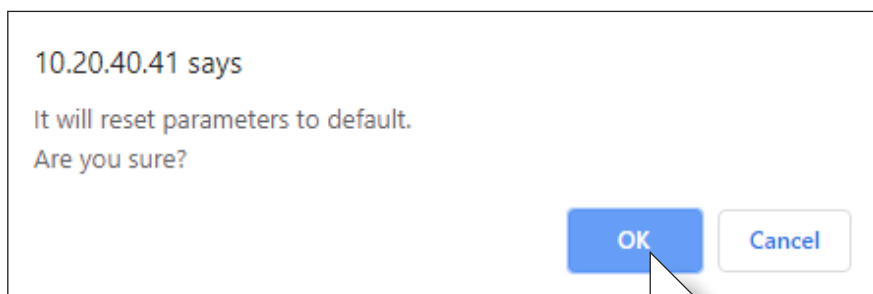

5. Once the factory-default process is complete, the web server **Login** screen will be displayed.
6. The factory-reset process is complete.

### Using the Front Panel

1. Verify that the AT-UHD-SW-5000ED is powered.
2. Simultaneously *press and hold* the **INPUT** and **POWER** buttons for 15 seconds.
3. The input indicator will switch to **HDBaseT 1**.

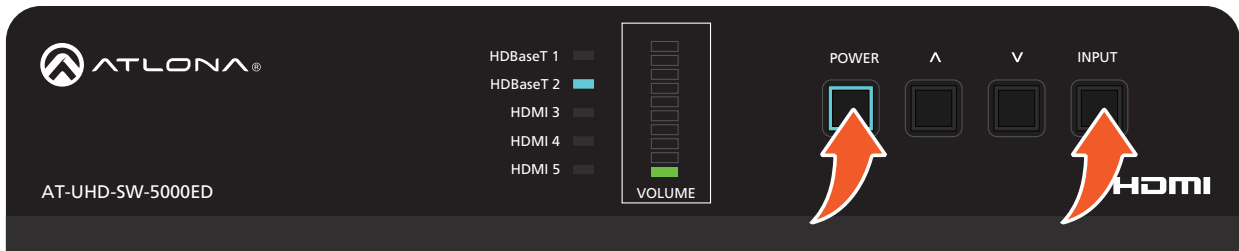

4. Factory reset is complete.

## Audio Management

The AT-UHD-SW-5000ED provides volume control and independent audio muting. Audio muting can be controlled on **HDMI OUT**, **HDBaseT OUT**, and **ANALOG OUT** ports. To de-embed the source audio on the **ANALOG OUT** port, connect the included 5-pin captive screw connector to the **ANALOG OUT** port. De-embedding audio is restricted to multichannel Linear PCM formats. Audio output is always downmixed to two-channel stereo.

### Adjusting Output Volume

1. Login to the web server. Refer to [Introduction to the Web Server \(page 38\)](#). The default username and password are listed below:

Username: root  
 Password: Atlona

2. Click **Settings** in the menu bar.
3. Under **Audio Settings**, click and drag the Volume slider to adjust the audio output level. The current output volume, in decibels, will be displayed in the Volume field, next to the slider bar. Audio output level can be set within the range of -80 dB to +15 dB. The default settings is 0 dB.

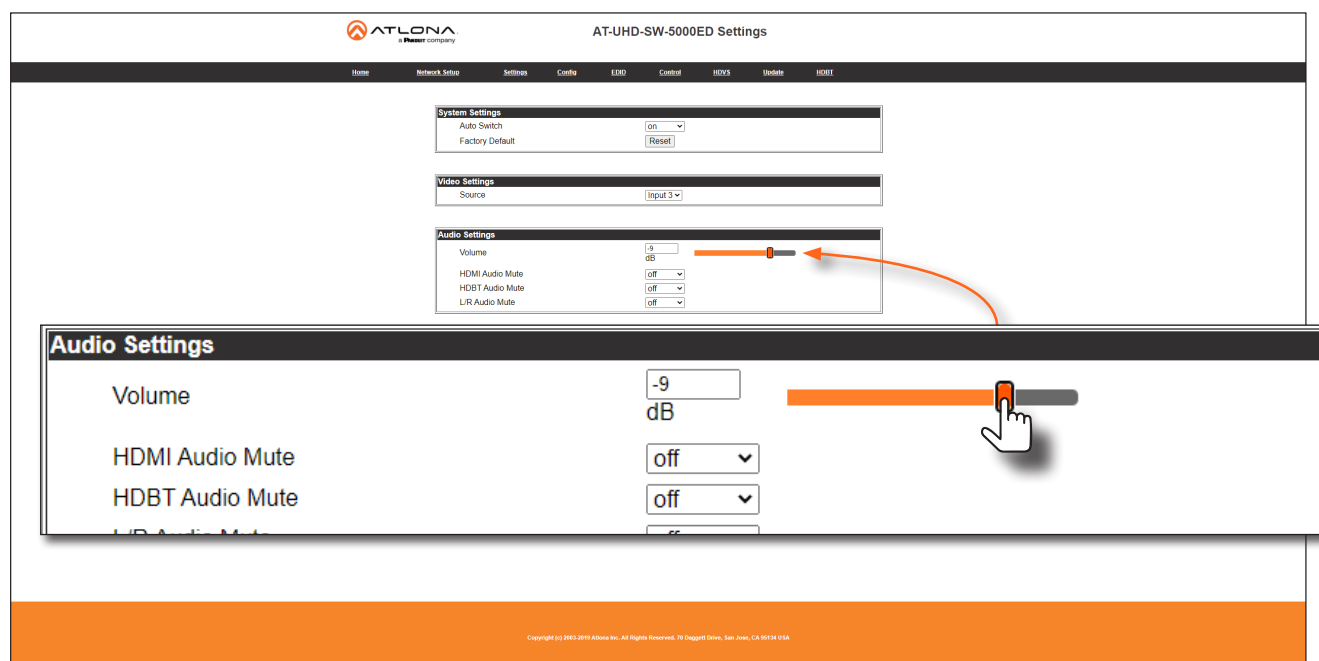

4. Output audio level adjustment is complete.

### Audio Output Muting

1. Login to the web server. Refer to [Introduction to the Web Server \(page 38\)](#). The default username and password are listed below:

Username: root  
Password: Atlona

2. Click **Settings** in the menu bar.
3. Locate the **Audio Settings** section.
4. Click the drop-down list for the desired output. For example, to mute the audio output on the **ANALOG OUT** port, click the **L/R Audio Mute** drop-down list and select **on**. To re-enable the audio for that output, select **off** from the drop-down list.

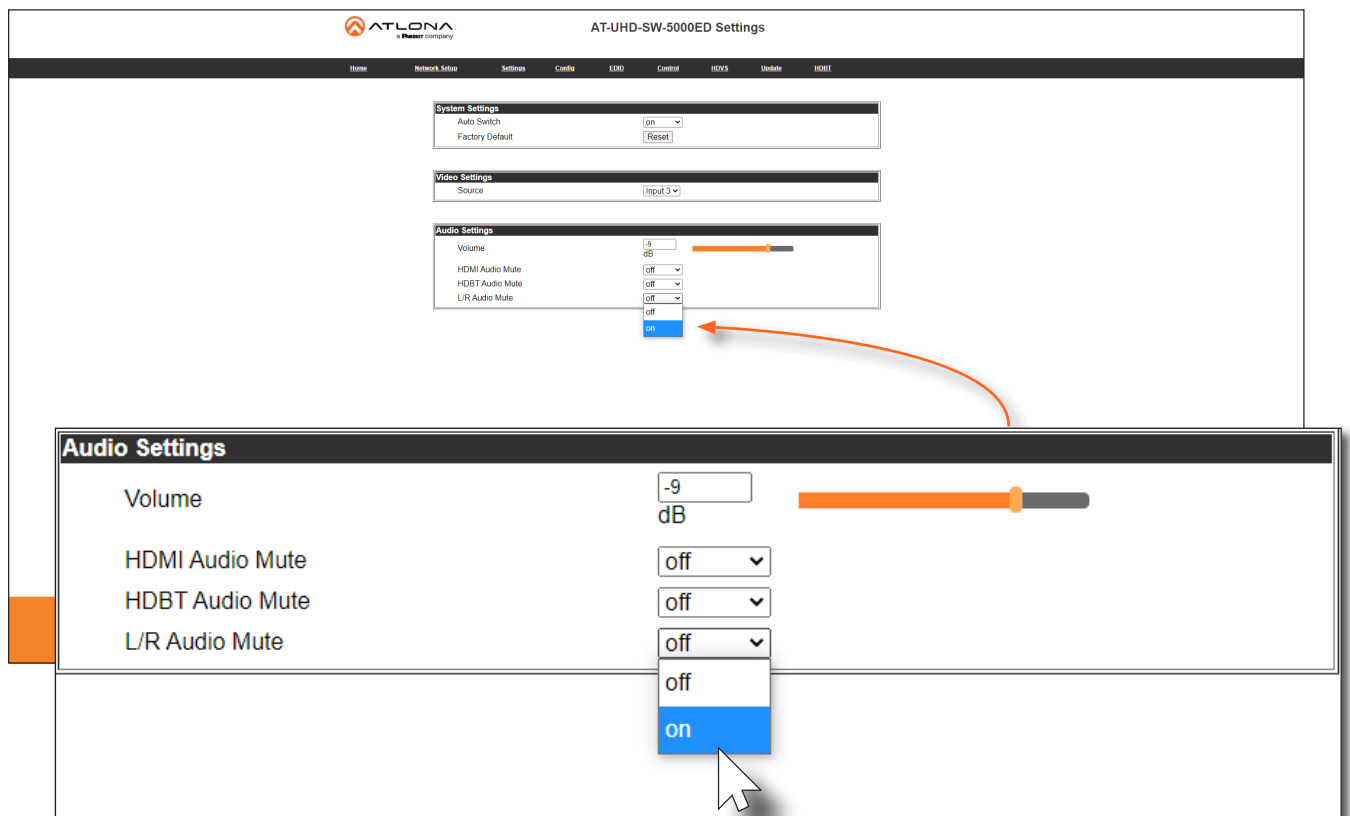

## User Management

The AT-UHD-SW-5000ED allows the administrator password to be changed. The password applies to both the web server and Telnet sessions. Note that the **Username** field cannot be changed. All users have the same level of access to control the AT-UHD-SW-5000ED. However, only the **root** user is allowed to manage other users. Up to three additional users can be created.

### Changing the Administrator Password

1. Login to the web server. Refer to [Introduction to the Web Server \(page 38\)](#). The default username and password are listed below:

Username: root  
 Password: Atlona

2. Click **Config** in the menu bar.
3. Click the **Password** field and enter the current password.



4. Under the **New user name and password** section, enter the new password in the **Password** field.
5. Verify the new password by entering it in the **PW again** field.
6. Click the **Save Settings** to commit changes. To login with the new username, close the web session, then enter the new password on the **Login** page.



**NOTE:** Password fields will always be masked for security purposes.

## Adding Users

1. Login to the web server. Refer to [Introduction to the Web Server \(page 38\)](#). The default username and password are listed below:

Username: root  
 Password: Atlona

2. Click **Config** in the menu bar.
3. Enter the desired username and password for the desired user field: **User 1**, **User 2**, and **User 3**.

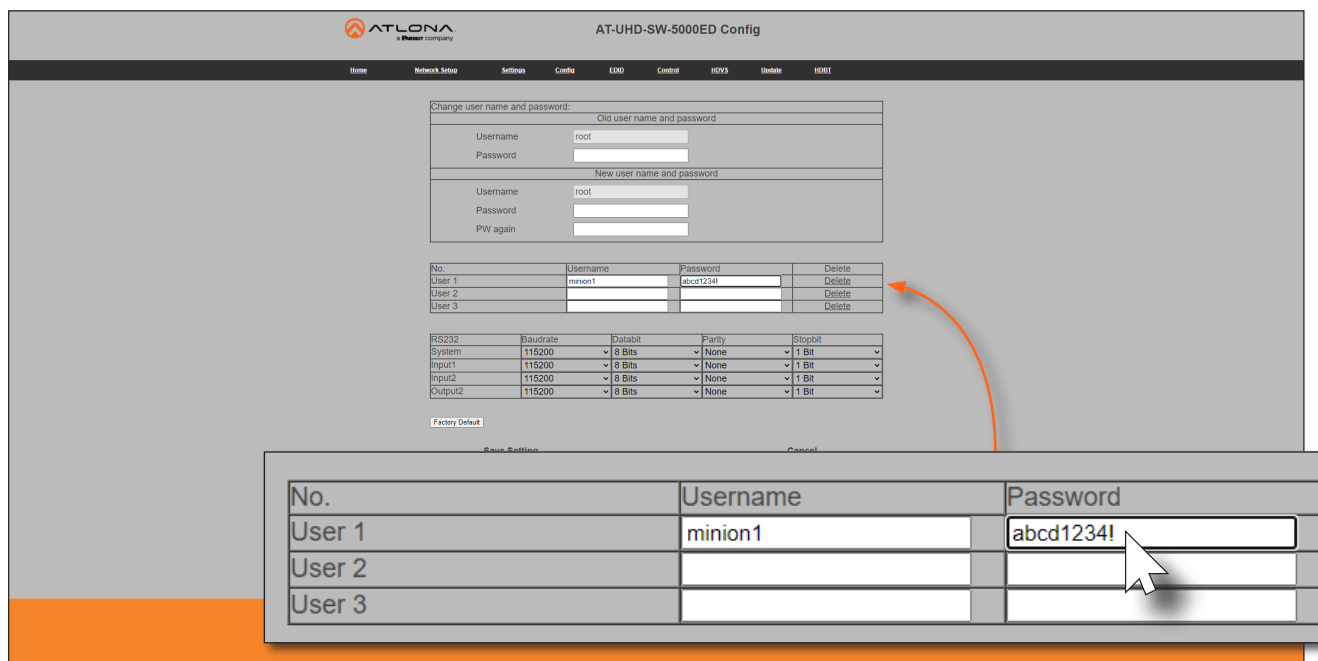

4. Click **Save Setting** to commit changes.
5. To login with the new username, close the web session, then enter the username and password on the **Login** page.

## Editing / Deleting Users

The username and password of a user can be changed using this method.

1. Login to the web server. Refer to [Introduction to the Web Server \(page 38\)](#). The default username and password are listed below:

Username: root  
Password: Atlona

2. Click **Config** in the menu bar.

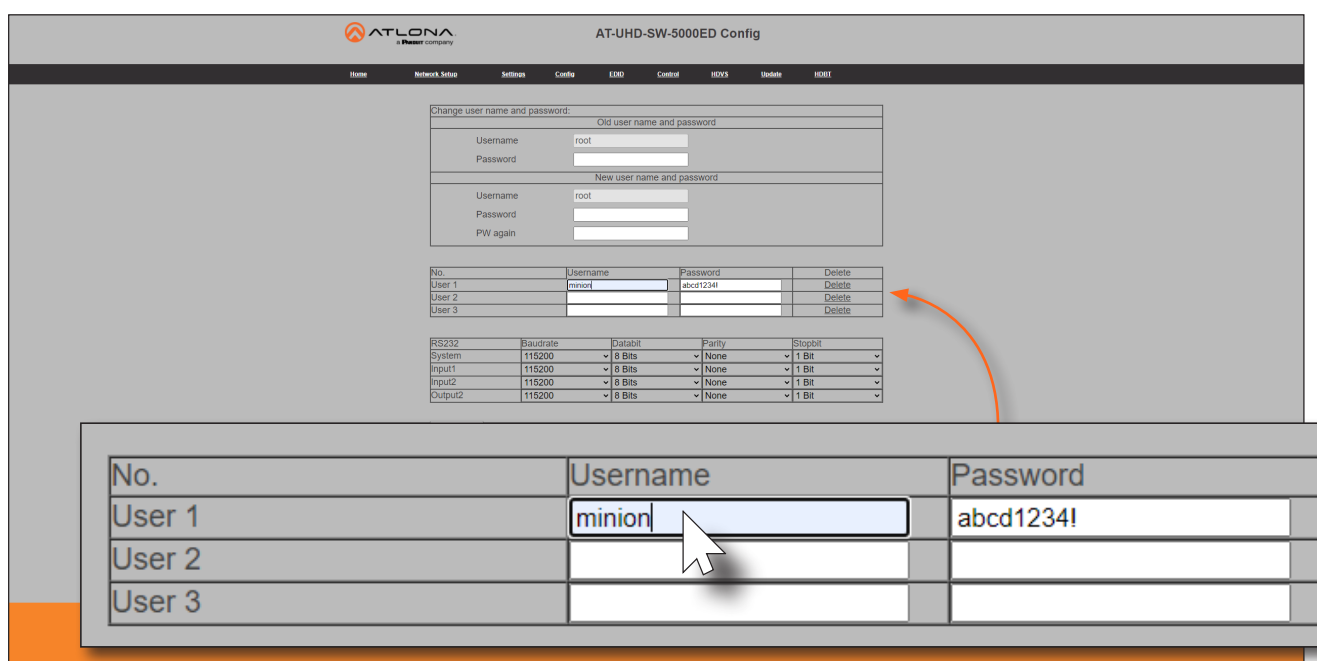

The screenshot shows the AT-UHD-SW-5000ED Config web interface. The 'Config' menu item is selected. The main content area displays a 'Change user name and password' form with fields for 'Old user name and password' (Username: root, Password: [redacted]) and 'New user name and password' (Username: root, Password: [redacted], PW again: [redacted]). Below the form is a table of users:

No.	Username	Password	Delete
User 1	minion	abcd1234!	Delete
User 2			Delete
User 3			Delete

Below the user table is a table of RS232 settings:

RS232	Baudrate	Databit	Parity	Stopbit
System	115200	8 Bits	None	1 Bit
Input1	115200	8 Bits	None	1 Bit
Input2	115200	8 Bits	None	1 Bit
Output2	115200	8 Bits	None	1 Bit

A red arrow points from the 'Delete' button in the user list to a magnified view of the table below:

No.	Username	Password
User 1	minion	abcd1234!
User 2		
User 3		

## Editing Users

- a. Click in the **Username** or **Password** field for the desired user and update the current information.
- b. Click **Save Setting** to commit changes. Click **Cancel** to abort changes.

## Deleting Users

- a. Click **Delete** in the row next to the user to be deleted. Note that no prompt will be provided to confirm the deletion of the desired user.



### EDID Management

Before a source can send picture and sound to a display device, the source reads the EDID (Extended Display Identification Data) structure, which is stored in the display. The EDID contains information about what type of video and audio formats are supported by the display. The AT-UHD-SW-5000ED can use either the downstream EDID (from the display/sink), and stored, or use a built-in EDID preset.

- EDID Presets
- Storing EDID Data

#### EDID Presets

The AT-UHD-SW-5000ED provides the option of selecting a preset EDID. The following presets are available. For information on **MEM\_1** through **MEM\_8** settings, refer to [Storing EDID Data \(page 35\)](#).



**IMPORTANT:** If problems are encountered when using an EDID preset, try selecting the **STD** EDID preset.

EDID listing	
STD	The default (generic) EDID for use with most displays.
ATL 1080P 2CH	1920 x 1080p @ 60 Hz with two-channel audio support.
ATL 1080P Multi CH	1920 x 1080p @ 60 Hz with multichannel audio support.
ATL 1080P DD	1920 x 1080p @ 60 Hz with Dolby® Digital audio support.
ATL 1080P 3D 2CH	1920 x 1080p @ 60 Hz with 3D and two-channel audio support.
ATL 1080P 3D Multi CH	1920 x 1080p @ 60 Hz with 3D and multichannel audio support.
ATL 1080P 3D DD	1920 x 1080p @ 60 Hz with 3D and Dolby® Digital audio support.
ATL 720P 2CH	1280 x 720p @ 60 Hz with two-channel audio support.
ATL 720P DD	1280 x 720p @ 60 Hz with Dolby® Digital audio support.
ATL 1280x800 RGB 2CH	1280 x 800 @ 60 Hz with RGB color space and two-channel audio support.
ATL 1366x768 RGB 2CH	1366 x 768 @ 60 Hz with RGB color space and two-channel audio support.
ATL 1080P DVI	1920 x 1080p @ 60 Hz DVI.
ATL 1280x800 RGB DVI	1280 x 800 with RGB color space DVI.
ATL 2160P 2CH	3840 x 2160 @ 60 Hz with two-channel audio support.
ATL 2160P Multi CH	3840 x 2160 @ 60 Hz with multichannel audio support.
ATL 4K420 (4:2:0) 2CH	4096 x 2160 (DCI) @ 60 Hz with 4:2:0 chroma and two-channel audio support.
ATL 4K420 (4:2:0) Multi CH	4096 x 2160 (DCI) @ 60 Hz with 4:2:0 chroma and multichannel audio support.
MEM_1 - MEM_8	Memory presets 1 through 8

1. Login to the web server. Refer to [Introduction to the Web Server \(page 38\)](#). The default username and password are listed below:

Username: root  
Password: Atlona

2. Click **EDID** in the menu bar.
3. Locate the **EDID Settings** section.

- Click the drop-down list, next to the port that is connected to the display device, and select the desired EDID preset. For example, if the **HDMI IN 3** port is connected to a display, click the **Input 3** drop-down list and select the EDID.

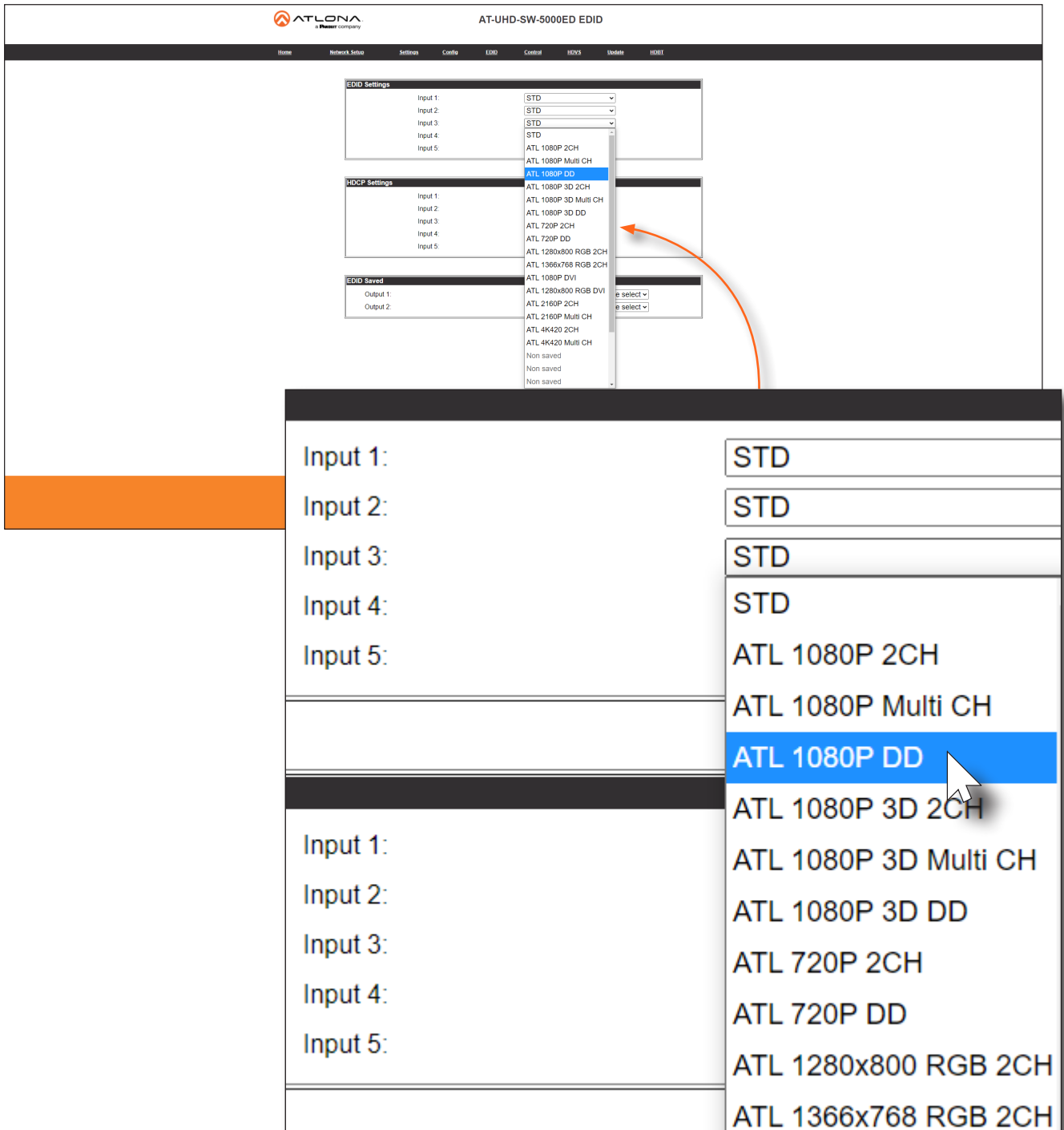

The screenshot displays the AT-UHD-SW-5000ED EDID configuration web interface. The main window shows settings for five inputs and two outputs. A dropdown menu is open for 'Input 3', listing various EDID presets. An orange arrow points from the 'Input 3' dropdown in the main window to the expanded menu. A mouse cursor is hovering over the 'ATL 1080P DD' option in the expanded menu.

Section	Input/Output	EDID Preset
EDID Settings	Input 1:	STD
	Input 2:	STD
	Input 3:	STD
	Input 4:	STD
	Input 5:	ATL 1080P 2CH
HDCP Settings	Input 1:	ATL 1080P 3D 2CH
	Input 2:	ATL 1080P 3D Multi CH
	Input 3:	ATL 1080P 3D DD
	Input 4:	ATL 720P 2CH
	Input 5:	ATL 720P DD
EDID Saved	Output 1:	ATL 1280x800 RGB 2CH
	Output 2:	ATL 1366x768 RGB 2CH

Input	EDID Preset
Input 1:	STD
Input 2:	STD
Input 3:	STD
Input 4:	STD
Input 5:	ATL 1080P 2CH
	ATL 1080P Multi CH
	<b>ATL 1080P DD</b>
	ATL 1080P 3D 2CH
	ATL 1080P 3D Multi CH
	ATL 1080P 3D DD
	ATL 720P 2CH
	ATL 720P DD
	ATL 1280x800 RGB 2CH
	ATL 1366x768 RGB 2CH

- EDID preset selection is complete.

### Storing EDID Data

The AT-UHD-SW-5000ED provides eight memory locations which can be used to store EDID data. Any downstream EDID can be captured and stored in these locations. Each memory location is non-volatile and captured EDID data is stored after power is disconnected from the unit.

1. Connect an HDMI cable from the **HDMI OUT** port on the AT-UHD-SW-5000ED to the HDMI input on the display, containing the EDID to be stored.



**NOTE:** The AT-UHD-SW-5000ED retains the currently selected input, even after the unit is powered-off then powered-on.

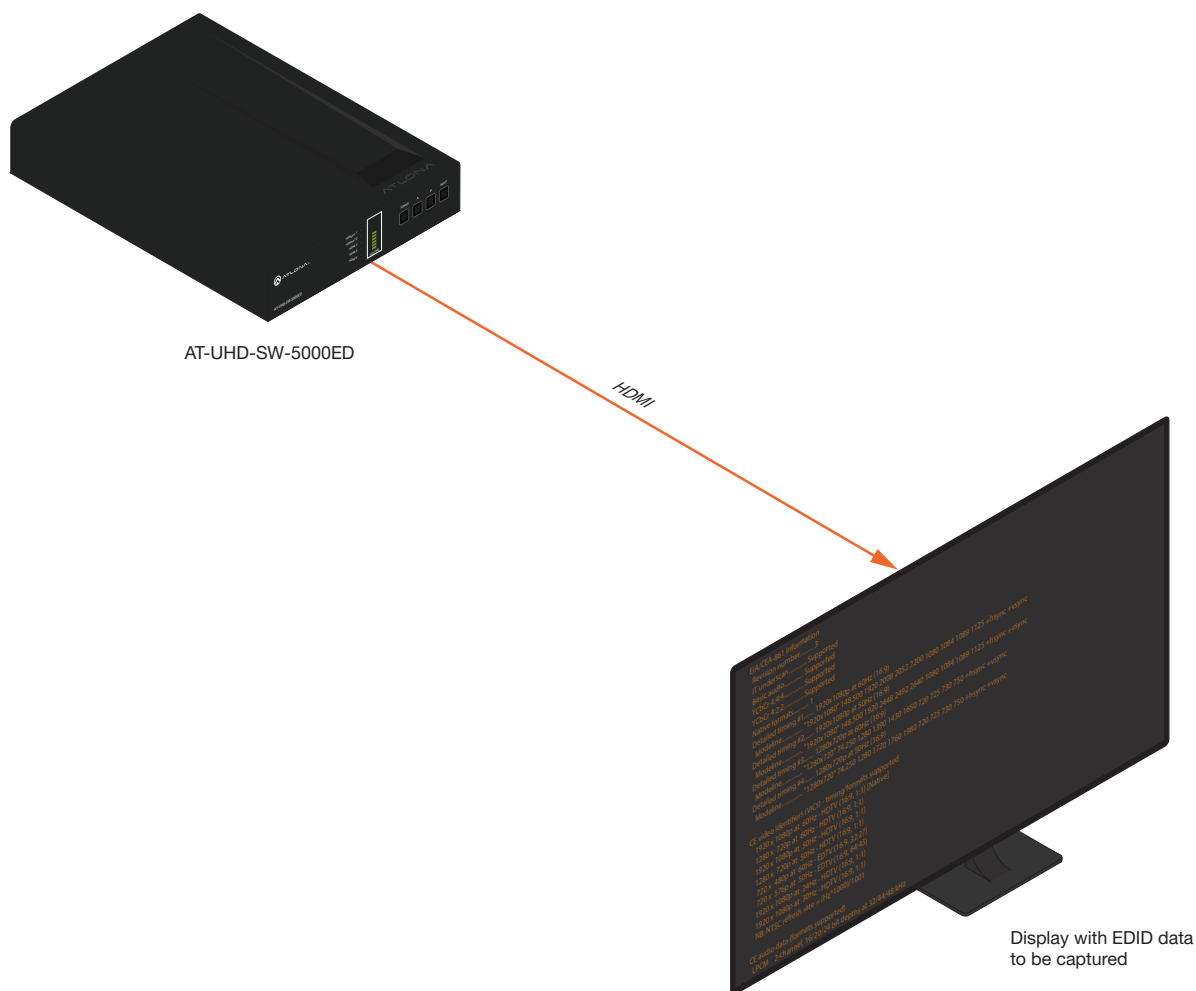

2. Login to the web server. Refer to [Introduction to the Web Server \(page 38\)](#). The default username and password are listed below:

Username: root  
Password: Atlona

3. Click **EDID** in the menu bar.
4. Locate the **EDID Saved** section.

- Click the drop-down list, next to the output which will be used to fetch the EDID. In this example, since the display is connected to the **HDMI OUT** port, a memory location next to the **Output 1** option is selected. Here, the EDID will be stored in **MEM\_1**.

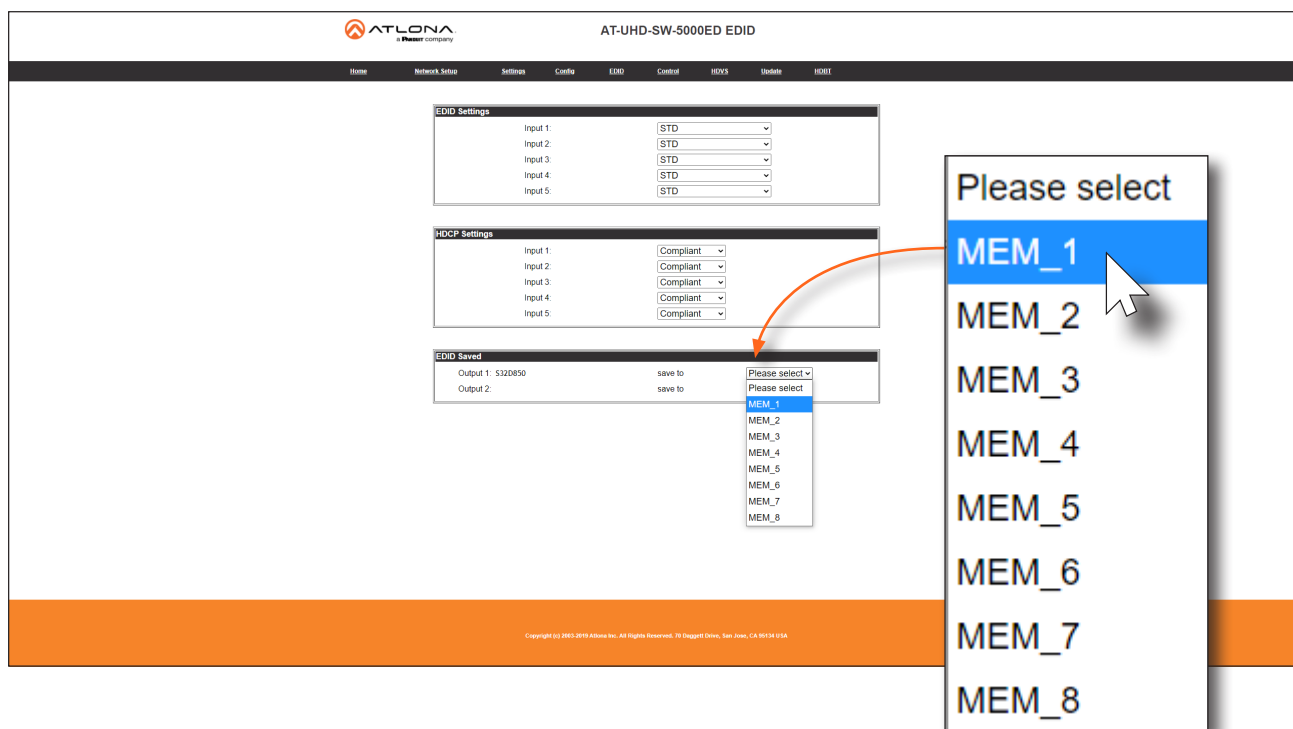

- The saved EDID will appear next to the memory location, as shown below.

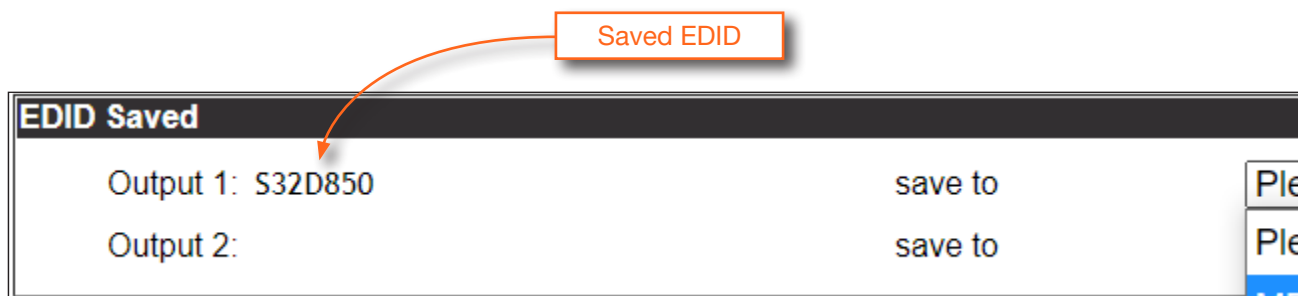

- Click any of the Input drop-down list boxes. Note that the stored EDID appears as an available EDID preset for each available input on the AT-UHD-SW-5000ED.
- The EDID storing procedure is completed.



**NOTE:** Once an EDID is written to a memory location, it can be overwritten with a different EDID, when desired. To overwrite an EDID with a different EDID, repeat steps 5 through 7, above.

## HDCP Content

Normally, if a source is transmitting HDCP content to a display that is not HDCP-compatible, then the resulting image on the display can be “snow”, image flickering, or no picture. For example, in the illustration below, a laptop source is connected to the AT-UHD-SW-5000ED. A non-compliant display is connected to a receiver, which is connected to the AT-UHD-EX-100CE-RX using HDBaseT.



**IMPORTANT:** Not all source devices are capable of transmitting non-HDCP content. For example, Sony PlayStation® gaming consoles and Mac® computers always transmit HDCP-encrypted content.

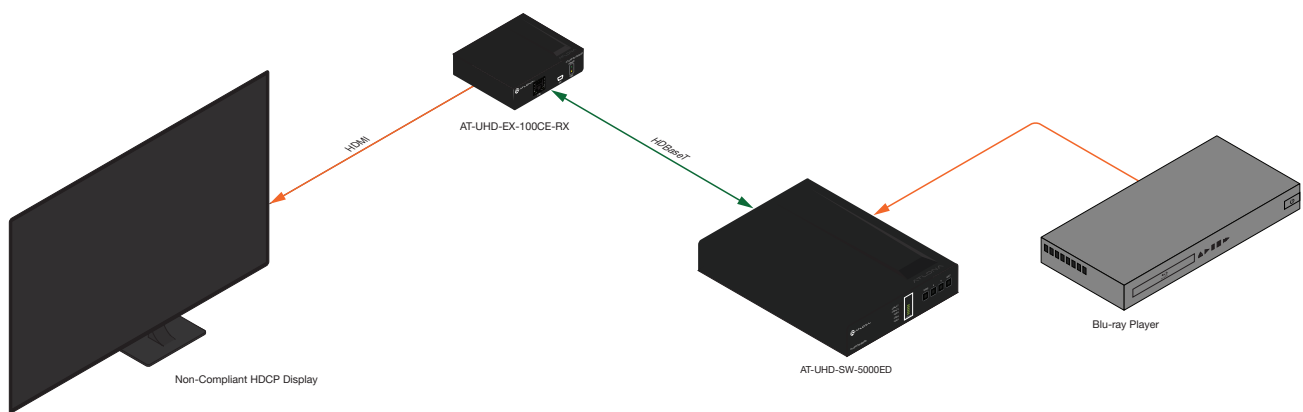

By default, the laptop may transmit HDCP content. However, when connected to a display that does not support HDCP, the laptop must be instructed to send non-HDCP content, in order for the content to be displayed.

1. Login to the web server. Refer to [Introduction to the Web Server \(page 38\)](#). The default username and password are listed below:  
  
 Username: root  
 Password: Atlona
2. Click **EDID** in the menu bar.
3. Locate the **HDCP Settings** section.
4. Click the drop-down list next to the desired input. For example, clicking the drop-down list, next to **Input 2**, and selecting **Noncompliant** will instruct the source device to send non-HDCP content, if possible.



# Configuration and Management Interfaces

## Introduction to the Web Server

The AT-UHD-SW-5000ED includes a built-in web server. Atlona recommends that the web server be used to set up the AT-UHD-SW-5000ED, as it provides intuitive management of all features. Follow the instructions below to access the webGUI.

1. Make sure that an Ethernet cable is connected between the LAN port on the AT-UHD-SW-5000ED and the network.
2. Launch a web browser and enter the IP address of the unit. If the default static IP address is being used, enter 192.168.1.254.
3. The AT-UHD-SW-5000ED **Login** page will be displayed.

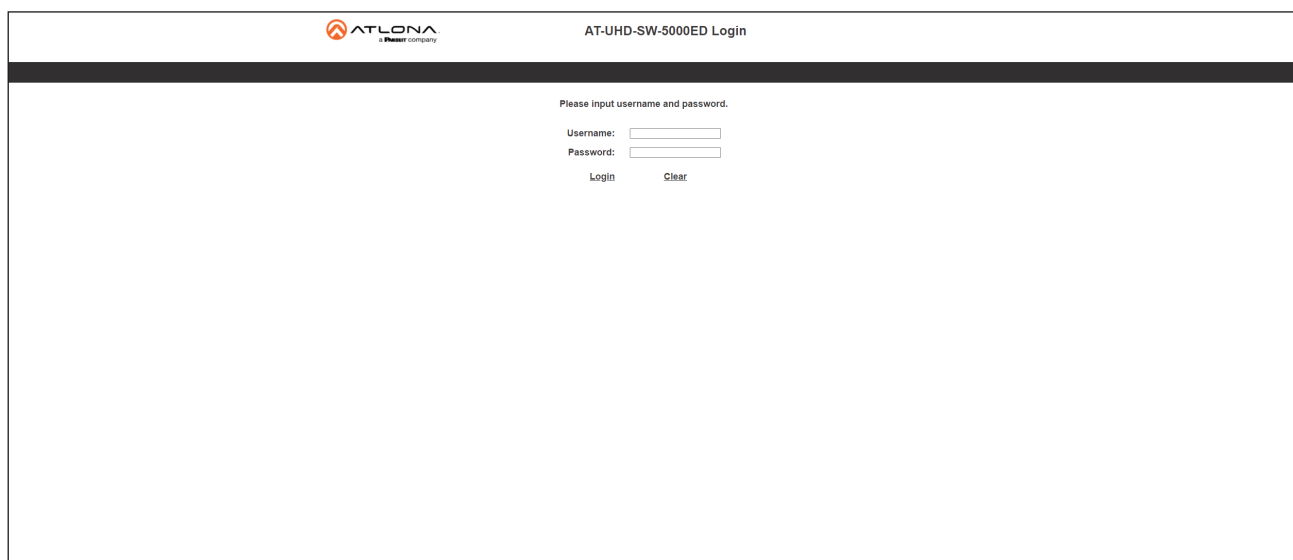

4. Enter the username and password in the **Username** and **Password** fields. The default username and password are listed below:

Username: root  
Password: Atlona

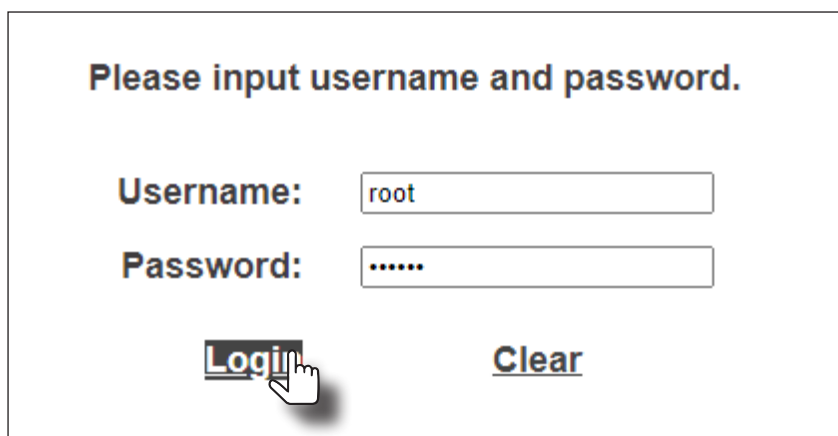

5. Click the **Login** button or press the ENTER key on the keyboard.

## Configuration and Management Interfaces

### Home Page

After logging in, the **Home** page will be displayed. The **Info** page provides various information about the AT-UHD-SW-5000ED, including software version and video information.

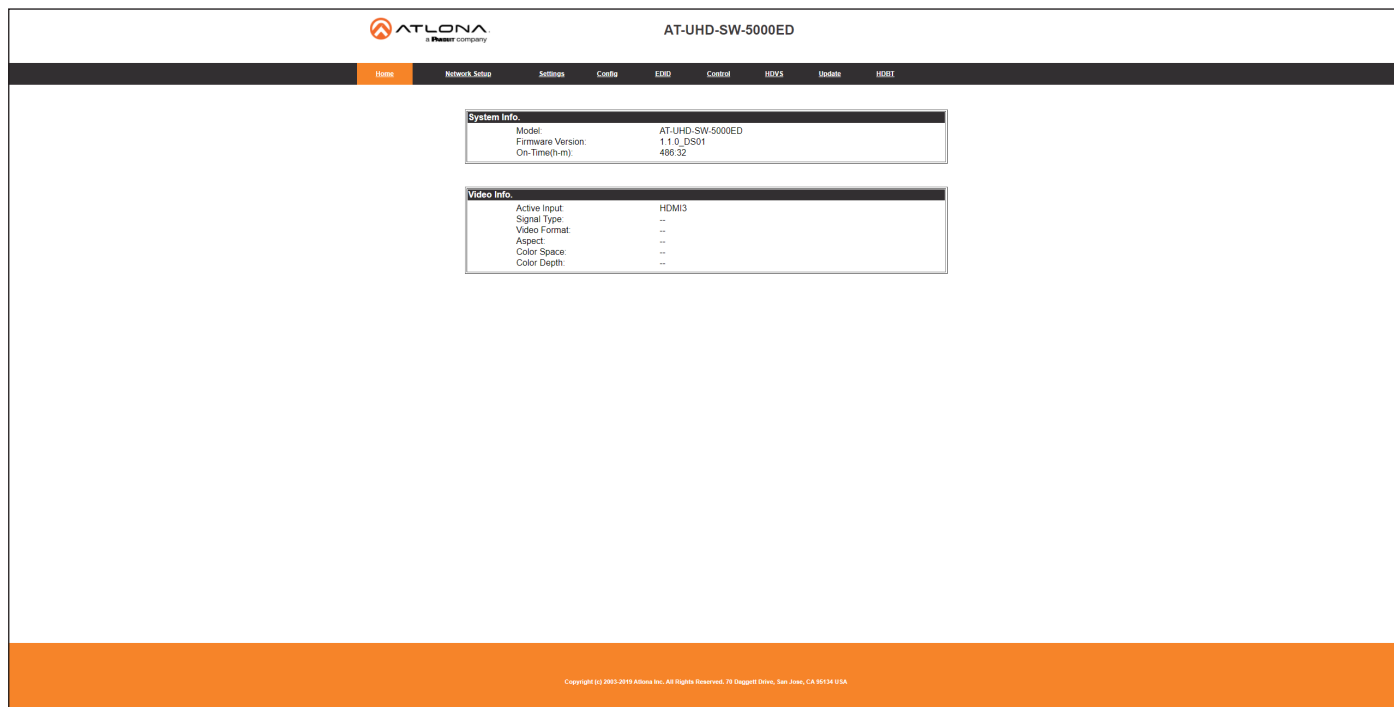

#### Model

The model SKU of this product.

#### Firmware Version

The version of firmware that the AT-UHD-SW-5000ED is running. Always make sure to check the AT-UHD-SW-5000ED product page, on the Atlona web site, for the latest version of firmware.

#### On-Time(h-m)

Displays how long the system has been powered since the last reboot/reset.

#### Active Input

The currently selected (active) input.

#### Signal Type

The type of input signal.

#### Video Format

The input resolution of the source device.

#### Aspect

Aspect ratio of the input signal.

#### Color Space

Displays the color space and chroma sub-sampling of the input signal.

#### Color Depth

The color depth of the input signal.

## Configuration and Management Interfaces

### Network Setup Page

The **Network Setup** page provides information about the current network settings of the AT-UHD-SW-5000ED. In addition, the network mode, Telnet port, and hostname can be assigned from this page.

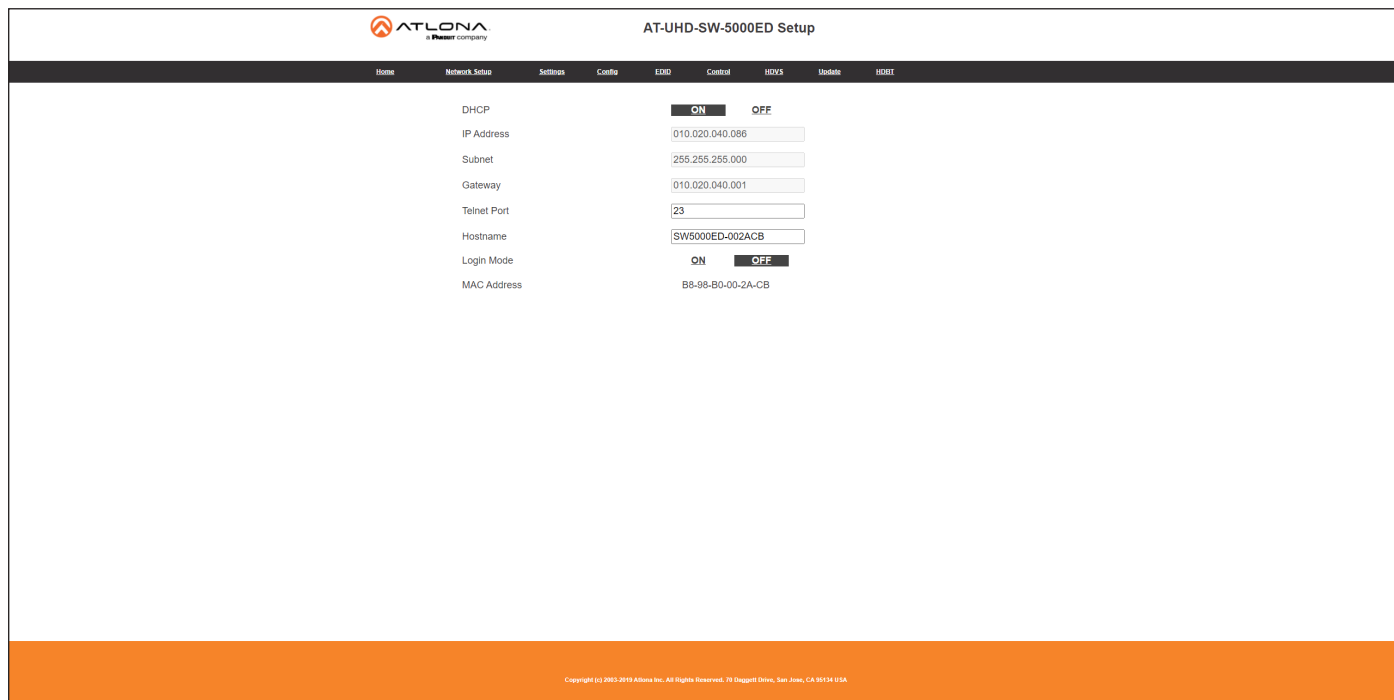

#### DHCP

Click the desired setting to switch the AT-UHD-SW-5000ED to **ON** or **OFF** mode. The default setting is **ON** mode. When set to **OFF**, the AT-UHD-SW52ED will be set to static IP mode. Refer to [Changing the Network IP Mode \(page 19\)](#) for more information.

#### IP Address

Enter the IP address of the AT-UHD-SW-5000ED in this field. This field will only be available when **DHCP** is set to **OFF**. The default static IP address of the AT-UHD-SW-5000ED is 192.168.1.254.

#### Subnet

Enter the subnet mask of the AT-UHD-SW-5000ED in this field. This field will only be available when **DHCP** is set to **OFF**.

#### Gateway

Enter the gateway (router) IP address in this field. This field will only be available when **DHCP** is set to **OFF**.

#### Telnet Port

Enter the desired Telnet port (for Telnet sessions) in this field. The default port is 23. Refer to [Changing the Telnet Port \(page 21\)](#) for more information.

#### Hostname

Displays the hostname of the AT-UHD-SW-5000ED, as it would appear on a network. To change the hostname, type the new hostname in this field. Refer to [Setting the Host Name \(page 23\)](#) for more information.

#### Login Mode

Click the desired setting to switch the Telnet Login Mode to **ON** or **OFF**. If set to **ON**, then login credentials (same as web server) will be required when starting a Telnet session.

#### MAC Address

This field displays the MAC address of the AT-UHD-SW-5000ED.



## Settings Page

The **Settings** page is divided into three sections: **Video**, **Audio**, and **HDCP**. The **Video** section provides controls for switching modes and input selection. The **Audio** section provides options to control the output audio volume and de-embedding. The **HDCP** section controls whether or not HDCP content is allowed to pass.

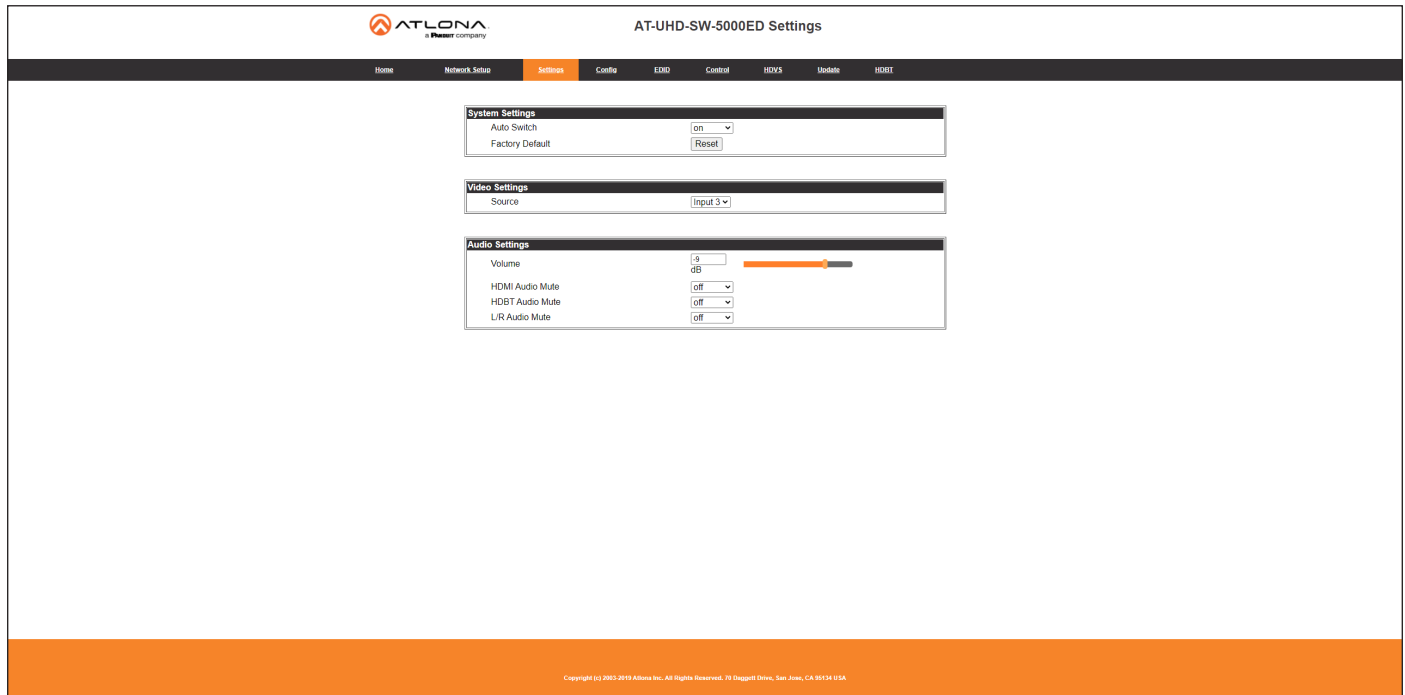

### Auto Switch

Click this drop-down list to set auto-switching to **on** or **off**. The default settings is **off**. When set to on, the AT-UHD-SW-5000ED will automatically switch to the last-connected port. Refer to [Enabling / Disabling Auto-Switching \(page 24\)](#).

### Factory Default

Click the **Reset** button to reset the AT-UHD-SW-5000ED to factory-default settings. Refer to [Resetting to Factory-Defaults \(page 26\)](#) for more information.

### Source

Click this drop-down list to select the desired input. Available inputs are **Input 1** through **Input 5**.

### Volume

Click and drag this slider to adjust the output volume. Output volume is measured in decibels (dB) and ranges from -80 to +15 dB. The default setting is 0 dB.

### HDMI Audio Mute

Click this drop-down list to control HDMI audio output muting. If set to **on**, then HDMI audio output will be muted.

### HDBaseT Audio Mute

Click this drop-down list to control HDBaseT audio output muting. If set to **on**, then HDBaseT audio output will be muted.

### L/R Audio Mute

Click this drop-down list to control analog audio output muting. If set to **on**, then the analog audio output will be muted.

### Factory Default

Click the **Factory Default** button to reset the current page to factory-default settings. Note that clicking this button *does not* reset the AT-UHD-SW-5000ED to factory settings.

## Configuration and Management Interfaces

### Config Page

The **Config** page provides management of the administrator password. The administrator username (“root”) cannot be changed. Refer to [User Management \(page 30\)](#) for more information. Up to three additional users can be managed within this page. This page also provides settings for both local and HDBaseT RS-232 control.

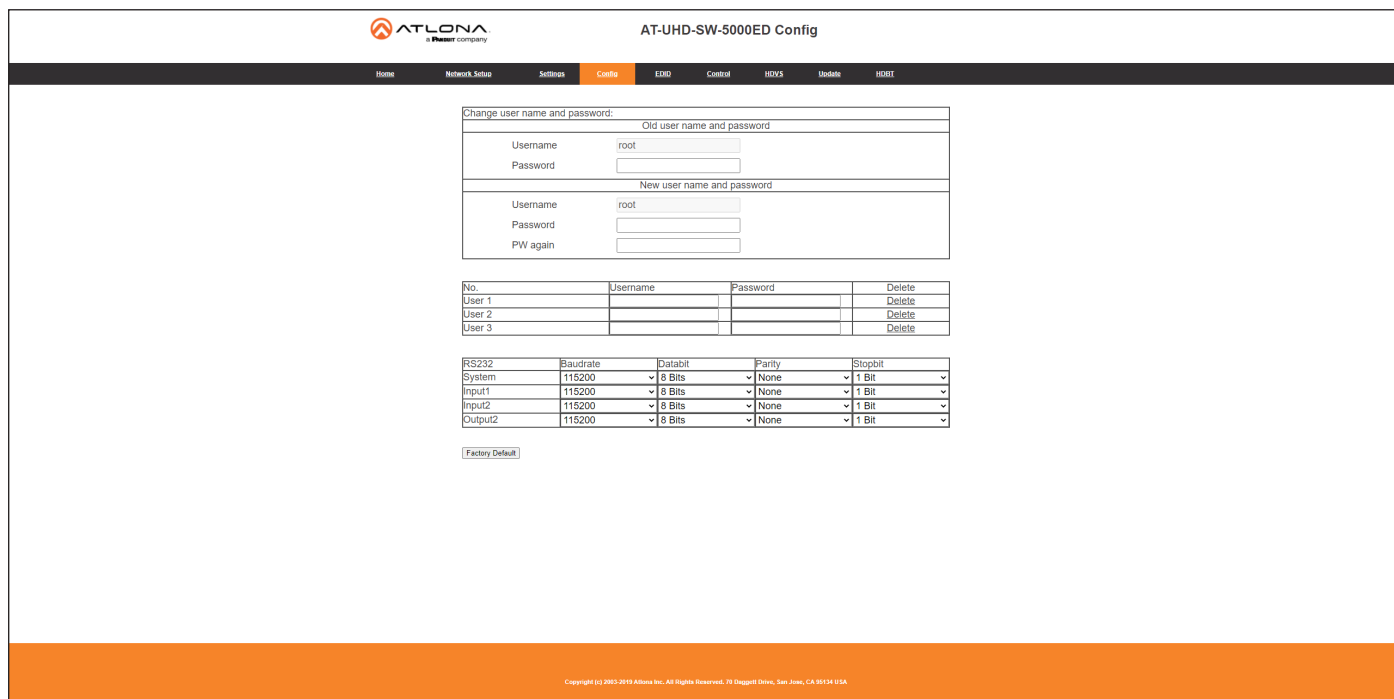

The screenshot shows the AT-UHD-SW-5000ED Config page with the following sections:

**Change user name and password:**

Old user name and password

Username	root
Password	

New user name and password

Username	root
Password	
PW again	

**User Management Table:**

No.	Username	Password	Delete
User 1			Delete
User 2			Delete
User 3			Delete

**RS232 Settings Table:**

RS232	Baudrate	Databit	Parity	Stopbit
System	115200	8 Bits	None	1 Bit
Input1	115200	8 Bits	None	1 Bit
Input2	115200	8 Bits	None	1 Bit
Output2	115200	8 Bits	None	1 Bit

Factory Default

Copyright (c) 2007-2019 Atlona Inc. All Rights Reserved. 70 Daguerre Drive, San Jose, CA 95134 USA

#### Username (old)

This field cannot be changed. “root” is the administrator user.

#### Password (old)

Enter the current password for the “root” username in this field. The default password is “Atlona”.

#### Username (new)

Enter the new username in this field.

#### Password (new)

Enter the new password in this field.

#### PW again

Verify the new password by retyping it in this field.

#### User 1 - User 3

Enter the username and password for each user in the respective fields. Click **Delete** to remove a user.

## Configuration and Management Interfaces

### System

Sets the RS-232 port settings and used for local control by a third-party control system.

### Output2

If the AT-UHD-SW-5000ED is connected to a device such as the AT-UHD-EX-100CE-RX-PSE, the drop-down list can be set to the baud rate of the HDBaseT RS-232 settings on the corresponding device. If the AT-UHD-SW-5000ED is connected to another HDBaseT device, such as the AT-UHD-CLSO-824, the drop-down list will be disabled and the HDBaseT baud rate will be locked at 115200.

Setting	Description
Baud rate	Sets the baud rate. The following options are available: 2400, 9600, 19200, 38400, 56000, 57600, 115200.
Data bit	Sets the number of data bits used to represent each character of data. The following options are available: 7 or 8.
Parity	Sets the parity bit, which can be included with each character to detect errors during the transmission of data. The following options are available: None, Odd, or Even.
Stop bit	Sets the stop bit. Stop bits are sent at the end of each character, allowing the client to detect the end of a character stream. The following options are available: 1 or 2.

### Factory Default

Click the **Factory Default** button to reset the current page to factory-default settings. Note that clicking this button *does not* reset the AT-UHD-SW-5000ED to factory settings.

### EDID Page

This page provides controls for selecting and storing EDID data. Refer to [EDID Management \(page 33\)](#) for more information.

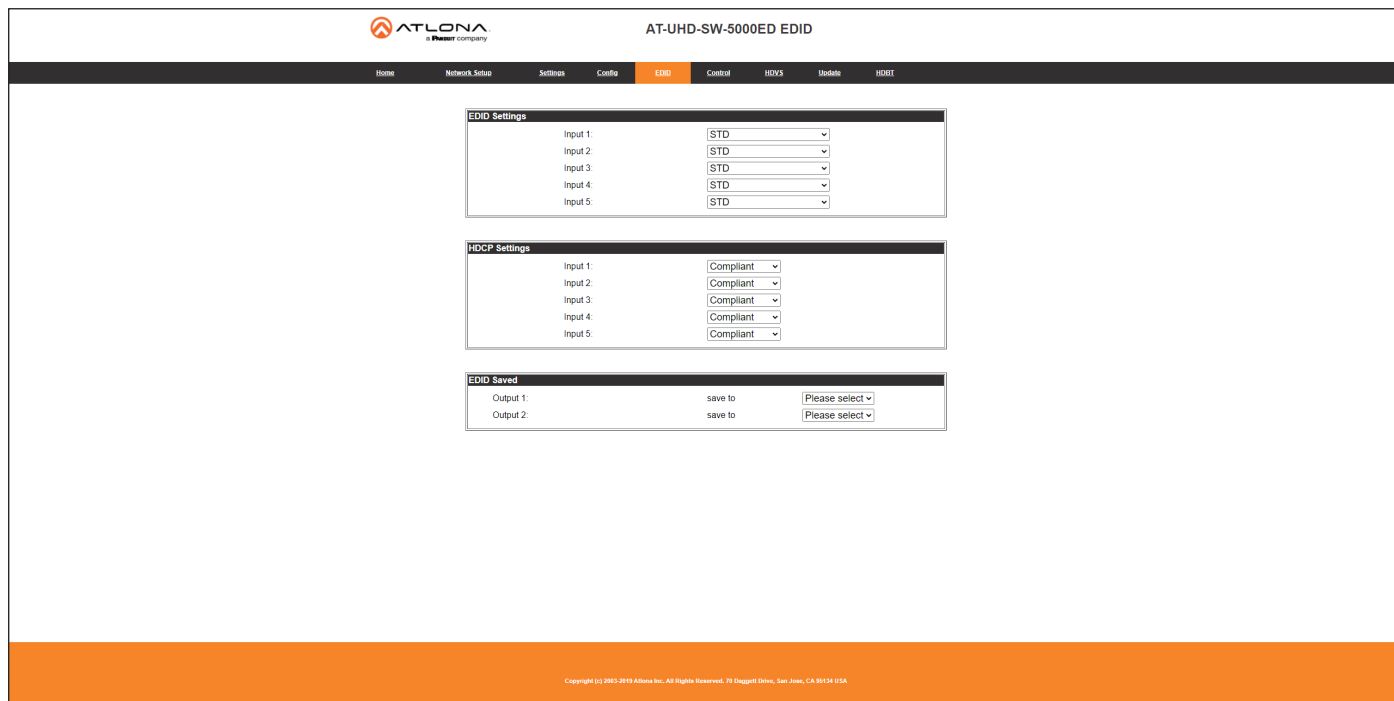

### EDID Settings

Click these drop-down lists to select the desired EDID to be used for each input. The following EDID presets are available. When selecting an EDID, make sure that the display/sink device is capable of supporting the resolution/timing. If the sink device is not able to support a feature, then the source will not be displayed. Selecting the **STD** EDID will provide the most compatible settings for most displays. In addition, eight memory locations are available for storing captured EDID data. If an EDID is stored in a memory location, it will also be added to the list available EDID selections.

EDID listing	
STD	ATL 2160P 2CH
ATL 1080P 2CH	ATL 2160P Multi CH
ATL 1080P Multi CH	ATL 4K420 (4:2:0) 2CH
ATL 1080P DD	ATL 4K420 (4:2:0) Multi CH
ATL 1080P 3D 2CH	MEM_1
ATL 1080P 3D Multi CH	MEM_2
ATL 1080P 3D DD	MEM_3
ATL 720P 2CH	MEM_4
ATL 720P DD	MEM_5
ATL 1280x800 RGB 2CH	MEM_6
ATL 1366x768 RGB 2CH	MEM_7
ATL 1080P DVI	MEM_8
ATL 1280x800 RGB DVI	

## Configuration and Management Interfaces

---

### HDCP Settings

Each input provides control of how HDCP content is handled. Some source devices will send HDCP content if an HDCP-compliant display (sink) is detected. However, there may be applications where sending HDCP content is not desired. Setting the port to the **OFF** position, will instruct the source to send non-HDCP content to the display. Note that not all sources have this capability.



**NOTE:** Setting this feature to **OFF**, for any source, does *not* provide decryption of HDCP content to non-HDCP compliant sink devices. Sources such as Mac<sup>®</sup> computers and the Sony PlayStation<sup>®</sup> will *always* transmit HDCP content.

- **Compliant**

When set to **Compliant**, the source will transmit HDCP content to the AT-UHD-SW-5000ED.

- **Noncompliant**

When set to **Noncompliant**, non-HDCP content will be transmitted (if possible) to the AT-UHD-SW-5000ED.

### EDID Saved

The AT-UHD-SW-5000ED provides eight memory locations used for storing captured EDID data. Click these drop-down lists to select and store the external EDID. Output 1 refers to the **HDMI OUT** port and Output 2 refers to the **HDBaseT OUT** port.

### Control Page

This page provides controls for CEC, device timers, and configuration for controlling external devices.



**NOTE:** To display all settings on the screen, as shown below, the **Display Auto Power** drop-down list must be set to **Enabled**.

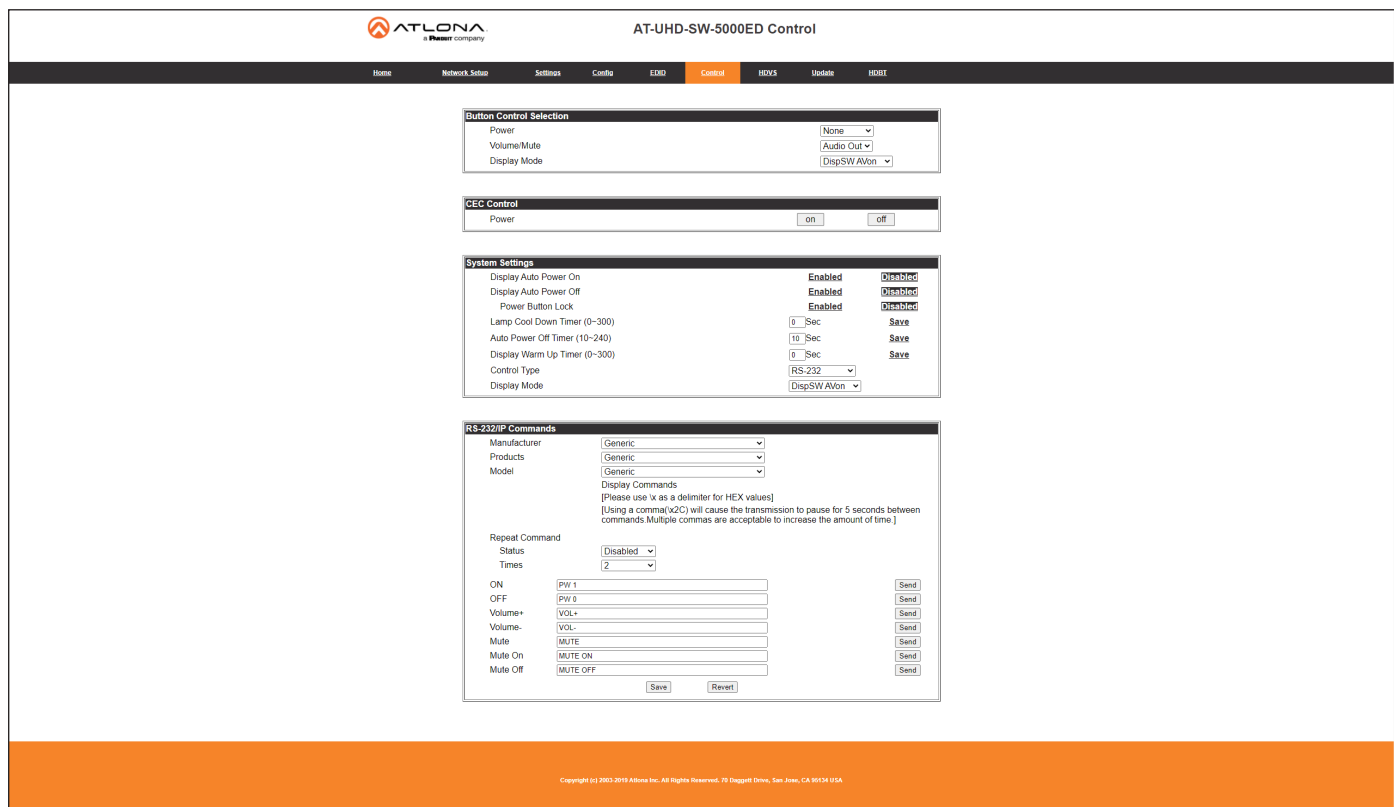

The screenshot shows the AT-UHD-SW-5000ED Control interface with the following sections:

- Button Control Selection:** Power (None), Volume/Mute (Audio Out), Display Mode (DispSW A/Won).
- CEC Control:** Power (on/off).
- System Settings:** Display Auto Power On (Enabled), Display Auto Power Off (Enabled), Power Button Lock (Enabled), Lamp Cool Down Timer (0-300) (0 Sec), Auto Power Off Timer (10-240) (10 Sec), Display Warm Up Timer (0-300) (0 Sec), Control Type (RS-232), Display Mode (DispSW A/Won).
- RS-232/IP Commands:** Manufacturer (Generic), Products (Generic), Model (Generic), Display Commands (Generic), Repeat Command Status (Disabled), Times (2), and various command fields (ON, OFF, Volume+, Volume-, Mute, Mute On, Mute Off) with Send buttons.

### Power

Click this drop-down list to select the control protocol for the **POWER** button on the front panel. Available options are **None**, **CEC**, **RS-232**, or **IP**. To power-on and power-off the AT-UHD-SW-5000ED, set this drop-down list to **None**.

### Volume/Mute

Click this drop-down list to select the control protocol for the **Volume/muting** buttons on the front panel. Available options are **Audio Out**, **RS-232**, or **IP**.

Setting	Description
Audio Out	Volume and mute buttons will control the volume output of the AT-UHD-SW-5000ED.
RS-232	Volume/Mute buttons will send RS-232 commands over HDBaseT to compatible receivers and displays.
IP	Volume/Mute buttons will send the commands over Ethernet using either the <b>LAN</b> port or the <b>CAT5e/6/7</b> (HDBaseT) port.

## Configuration and Management Interfaces

### Display Mode

Click this drop-down list to select the power mode for the source / display.

Setting	Description
DispSW AVon	Display switches on/off, source audio/video signal always on.
DispSW AVSW	Display switches on/off, source audio/video signal switches on/off.
AV SW	Display is always on, source audio/video signal switches on/off
Always ON	Both source and display are always on.

### CEC Control

Click the **on** and **off** buttons to test power-on and power-off CEC commands, respectively.

### Display Auto Power On

Set this toggle to **ENABLED** to allow the AT-UHD-SW-5000ED to send the power-on command to the display when an A/V signal is detected. When the AV signal is no longer present, the AT-UHD-SW-5000ED will send the power-off command to the display. If this feature is not desired, then set to **DISABLED**. This feature is disabled by default.

### Display Auto Power Off

Set this toggle to **ENABLED** to allow the AT-UHD-SW-5000ED to send the power-off command to the display when an A/V signal is detected. If this feature is not desired, then set to **DISABLED**. This feature is disabled by default.

### Power Button Lock

Set this toggle to **ENABLED** to prevent the AT-UHD-SW-5000ED from being powered-off, if the POWER button is accidentally pressed.

### Lamp cool down timer

Sets the cool-down interval, in seconds, before the projector is powered-off. During this time interval, the projector will not accept any "power on" or "power off" commands until the last "power off" command has been processed and the projector lamp has completed the cool-down cycle. Available values are 15 seconds to 15 minutes. The default setting is 10 seconds.

### Auto power off timer

Sets the time interval before the command to power-off the display is sent, when an A/V signal is no longer present. The default value is 15 seconds. Available values are 15 seconds to 15 minutes.

### Display Warm-Up Timer

Click this drop-down list to select the display warm-up time interval. Available values are 10 to 300 seconds. The default value is 10 seconds.

### Control Type

Click this drop-down to select the control type. Available settings are **CEC\***, **IP**, and **RS-232**. When this drop-down list is set to **CEC**, the **RS-232/IP Commands** window group will be hidden.

*\* Consumer Electronics Control (CEC): Atlona has confirmed proper CEC functionality with several current models of Samsung, Panasonic, and Sony displays. However, it is not guaranteed that CEC will work with all displays. Many manufacturers do not support the CEC "off" command, and older displays use proprietary commands. Atlona only supports displays that use the CEC command structure defined in HDMI 1.2a. It is recommended that dealers request an evaluation product from Atlona, before designing a system using the CEC protocol. If this is not possible, then other control methods will need to be considered, in order to control displays using Atlona products.*

## Configuration and Management Interfaces

### Display Mode

Click this drop-down list to select the power mode for the source / display.

Setting	Description
DispSW AVon	Display switches on/off, source audio/video signal always on.
DispSW AVSW	Display switches on/off, source audio/video signal switches on/off.
AV SW	Display is always on, source audio/video signal switches on/off

### IP Mode

If the device does not require a login, then set this drop-down value to **Non-Login**. If the device requires login credentials, select **Login** from the drop-down list. Note that if **Login** is selected, then the **Username** and **Password** fields will need to be populated with the required login credentials.

### IP Address

Enter the IP address of the device to be controlled.

### Port

Enter the port in this field.

### Username

This field is only required if **IP Mode** is set to **Login**. Enter the username in this field.

### Password

This field is only required if **IP Mode** is set to **Login**. Enter the required password in this field.

### ASCII / Hex

Click these radio buttons to set the desired data transmission method.

### Test

Click these buttons to send the appropriate data to the unit being controlled.

### On/Off/Volume+/Volume-/Mute/

Enter the appropriate ASCII or Hex data string in each of these fields. Refer to the user manual for the display or device being controlled, for the proper command strings.

### Feedback

Enter the desired feedback string in this field. This field can be any string value.



## Configuration and Management Interfaces

### HDVS Page

This page provides management for HDVS HDBaseT transmitters that may be connected to the AT-UHD-SW-5000ED. If a transmitter is connected, then the device will be displayed under the associated input. In the example below, an AT-HDVS-210U-TX-WP is connected to **INPUT 2** on the AT-UHD-SW-5000ED. If the transmitter is connected to the Local Area Network (LAN), then the IP address will be displayed as a hyperlink. Clicking on the IP address will open a new browser window with the login page of the device.

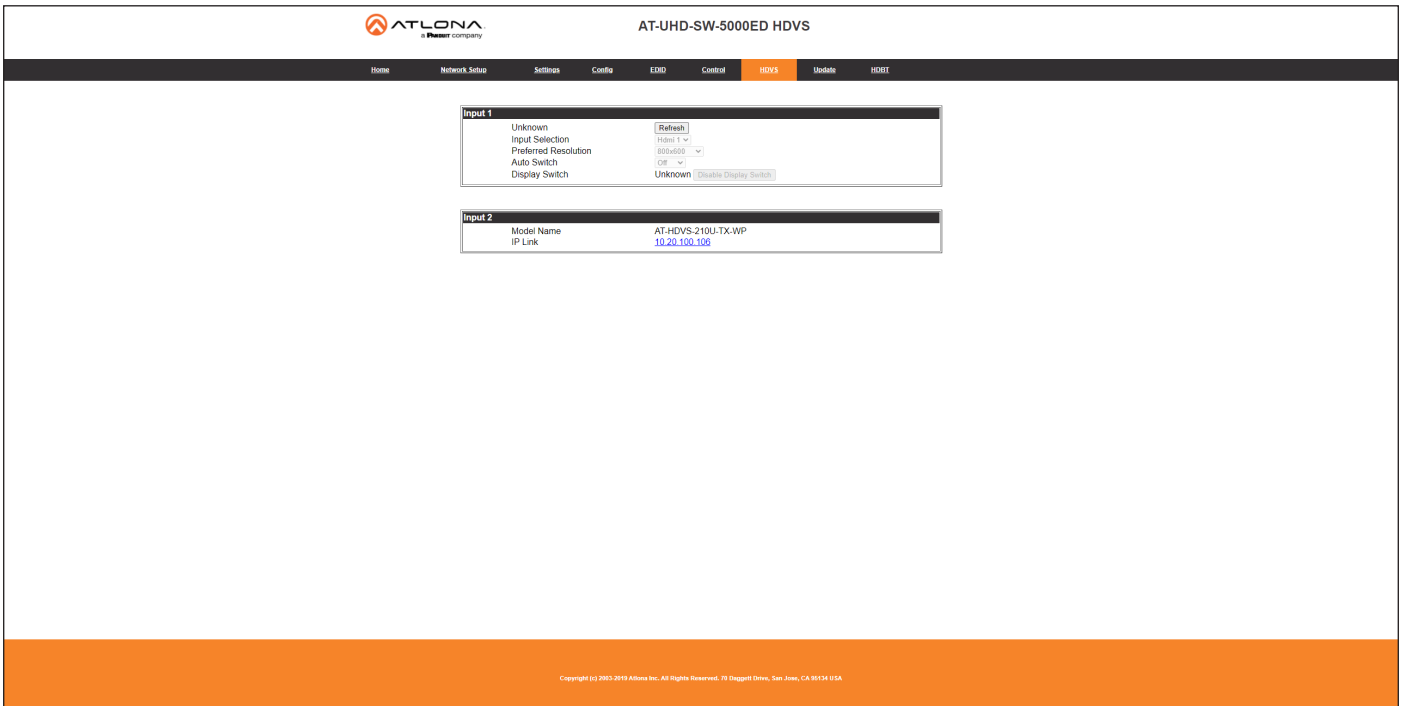

The screenshot displays the AT-UHD-SW-5000ED HDVS management interface. The top navigation bar includes links for Home, Network Setup, Settings, Config, EDID, Control, HDVS (active), Update, and HDBT. The main content area shows two input sections:

- Input 1:**
  - Unknown (Refresh)
  - Input Selection: HDBT 1
  - Preferred Resolution: 800x600
  - Auto Switch: OFF
  - Display Switch: Unknown (Disable Display Switch)
- Input 2:**
  - Model Name: AT-HDVS-210U-TX-WP
  - IP Link: [10.20.100.108](http://10.20.100.108)

Copyright © 2003-2019 Atlona Inc. All Rights Reserved. 70 Duggell Drive, San Jose, CA 95134 USA

### Refresh

Click this button to refresh the HDBaseT link on the associated input. This button will only be displayed if an HDVS unit is connected, but may not be recognized by the AT-UHD-SW-5000ED.

## Configuration and Management Interfaces

### Update Page

This page provides management for updating the AT-UHD-SW-5000ED firmware.

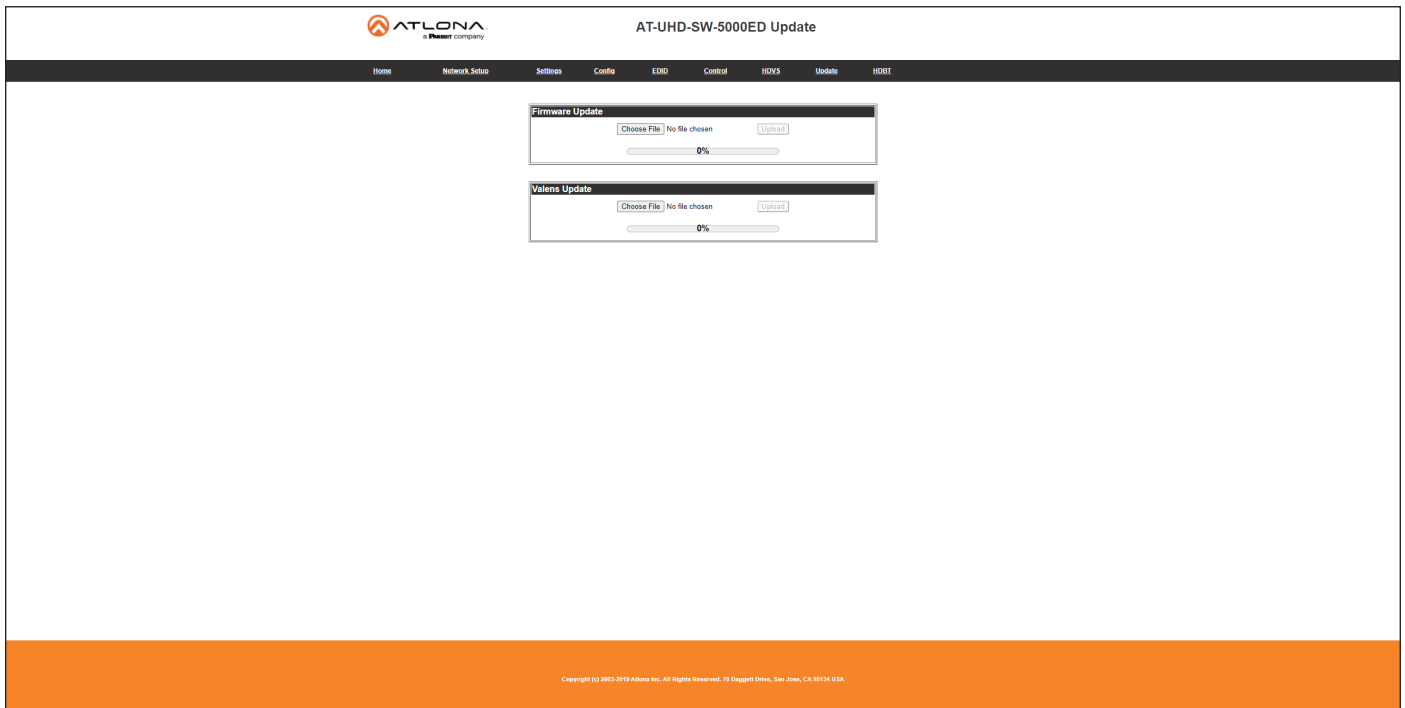

The screenshot shows the AT-UHD-SW-5000ED Update web interface. At the top, there is a navigation menu with the following items: Home, Network Setup, Settings, Config, EDD, Control, HDVS, Update, and HOST. Below the navigation menu, there are two update sections: 'Firmware Update' and 'Valens Update'. Each section contains a 'Choose File' button, the text 'No file chosen', an 'Upload' button, and a progress bar showing 0%.

#### Choose File

Click this button to select the firmware file to be uploaded to the AT-UHD-SW-5000ED. Note that this button is available for both the “master” firmware and Valens chip update.

#### Upload

Click this button to begin the firmware update process. Note that this button is available for both the “master” firmware and Valens chip update.

## HDBT Page

This page provides management for updating the AT-UHD-SW-5000ED firmware.

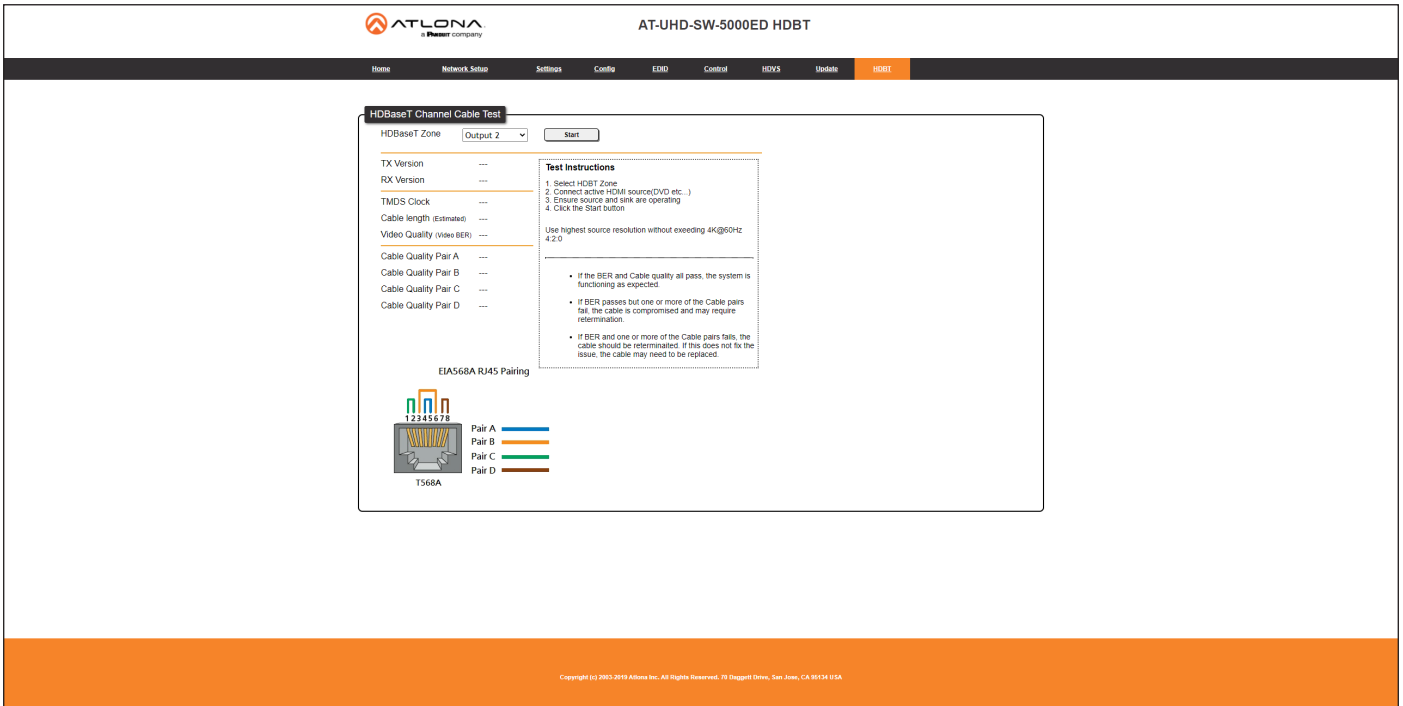

## HDBT Zone

Click this drop-down list to select the output channel (**ZONE OUT**) to test. Refer to [HDBaseT Testing \(page 55\)](#) for more information.

# Appendix

## Updating the Firmware

Updating the firmware can be completed using either the USB interface or the built-in web server. Atlona recommends using the web server for updating the firmware. However, if a network connection is not available, the AT-HDVS-210H-TX-WP firmware can be updated using a USB-A to USB mini-B cable.

### Using the Web Server

Requirements:

- AT-UHD-SW-5000ED
- Firmware file
- Computer on the same network as the AT-UHD-SW-5000ED

1. Download the firmware file from [atlona.com](http://atlona.com) and extract the contents of the .zip file to a folder on the computer desktop.
2. Connect an Ethernet cable from the computer, containing the firmware, to the same network where the AT-UHD-SW-5000ED is connected.
3. Login to the web server. Refer to [Introduction to the Web Server \(page 38\)](#). The default username and password are listed below:

Username: root  
 Password: Atlona

4. Click **Update** in the menu bar, then click the **Choose File** button, under the **Firmware Update** section.
5. Browse to the location of the firmware file, select it, and click the **Open** button.

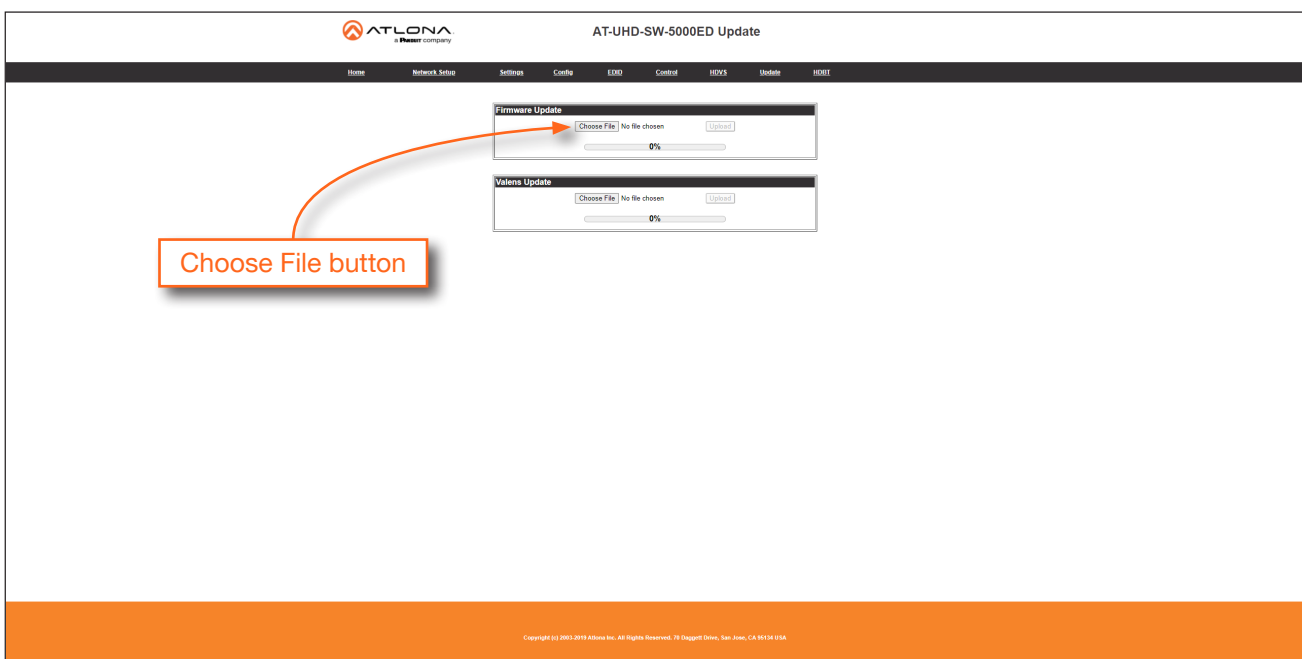

6. Click the **Upload** button, under the **Firmware Update** section.
7. A progress bar will be displayed during the update process. After the update is complete, and if a restart is required, the web server will display a prompt.
8. The AT-UHD-SW-5000ED is now ready for use.

### Using the USB Interface

Requirements:

- AT-UHD-SW-5000ED
- Firmware file
- Computer with a USB port
- USB-A to USB mini-B cable

1. Download the firmware file from [atlona.com](http://atlona.com) and extract the contents of the .zip file to a folder on the computer desktop.
2. Disconnect power from the AT-UHD-SW-5000ED.
3. Connect the USB-A to USB mini-B cable between the computer and the FW port on the AT-UHD-SW-5000ED.

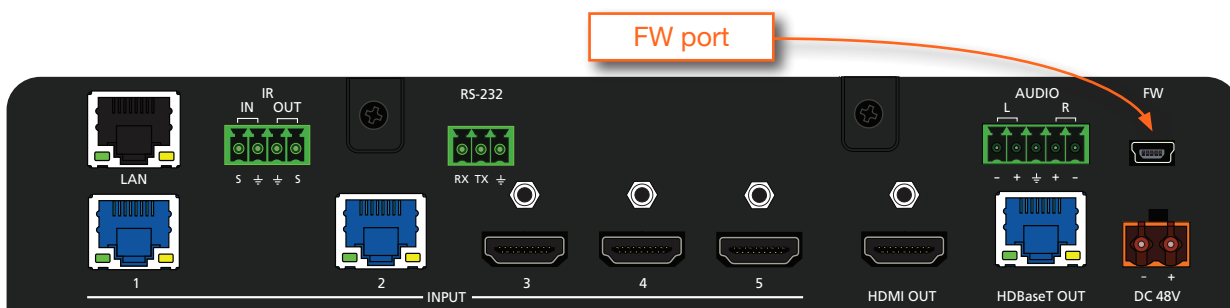

4. Simultaneously press and hold down the **INPUT** button on the front panel, while connecting the power supply to the AT-UHD-SW-5000ED. *Continue to hold down the **INPUT** key for five seconds AFTER the power supply has been connected.*
5. Release the **INPUT** key.

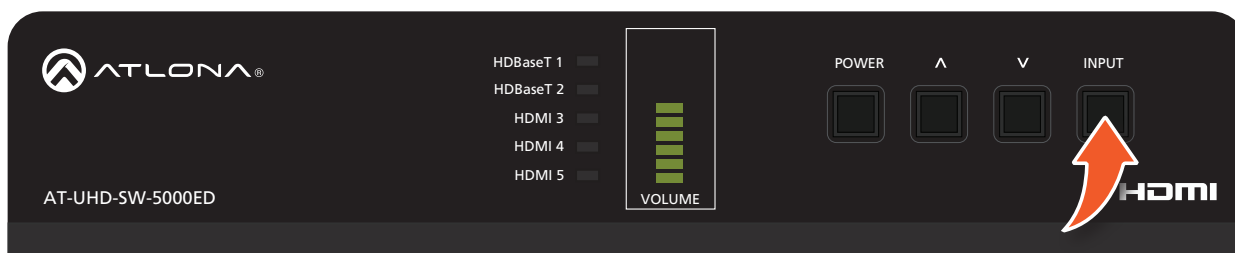

6. The USB UPDATE folder will be displayed.

If this folder is not displayed, automatically, select the USB UPDATE drive from Windows Explorer.

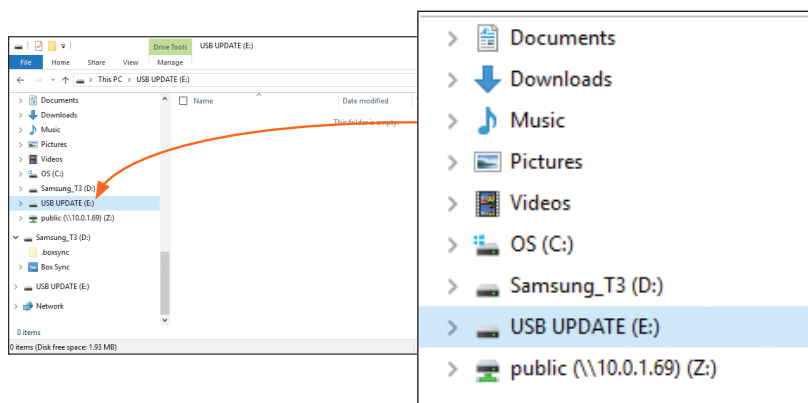

7. Delete all files from the USB UPDATE drive, if any are present.
8. Drag-and-drop the firmware file to the drive.
9. After the file has been copied, disconnect the USB cable from both the computer and the AT-UHD-SW-5000ED.
10. The firmware update process is complete and the AT-UHD-SW-5000ED is now ready for use.

## HDBaseT Testing

The web server of the AT-UHD-SW-5000ED provides a tool for testing the signal integrity of HDBaseT cables. This tool is useful for troubleshooting and identifying defective or damaged category cables which are connected from the HDBaseT INPUTS/OUTPUT ports to a receiver/transmitter.

1. Login to the web server. Refer to [Introduction to the Web Server \(page 38\)](#) for more information, if necessary.
2. Click **HDBT** in the top menu bar.
3. Click the **HDBT Zone** drop-down list and select the desired zone to test. Before testing a zone, make sure that an category cable is connected between the HDBaseT port (INPUT/OUTPUT) and a compatible transmitter/receiver.

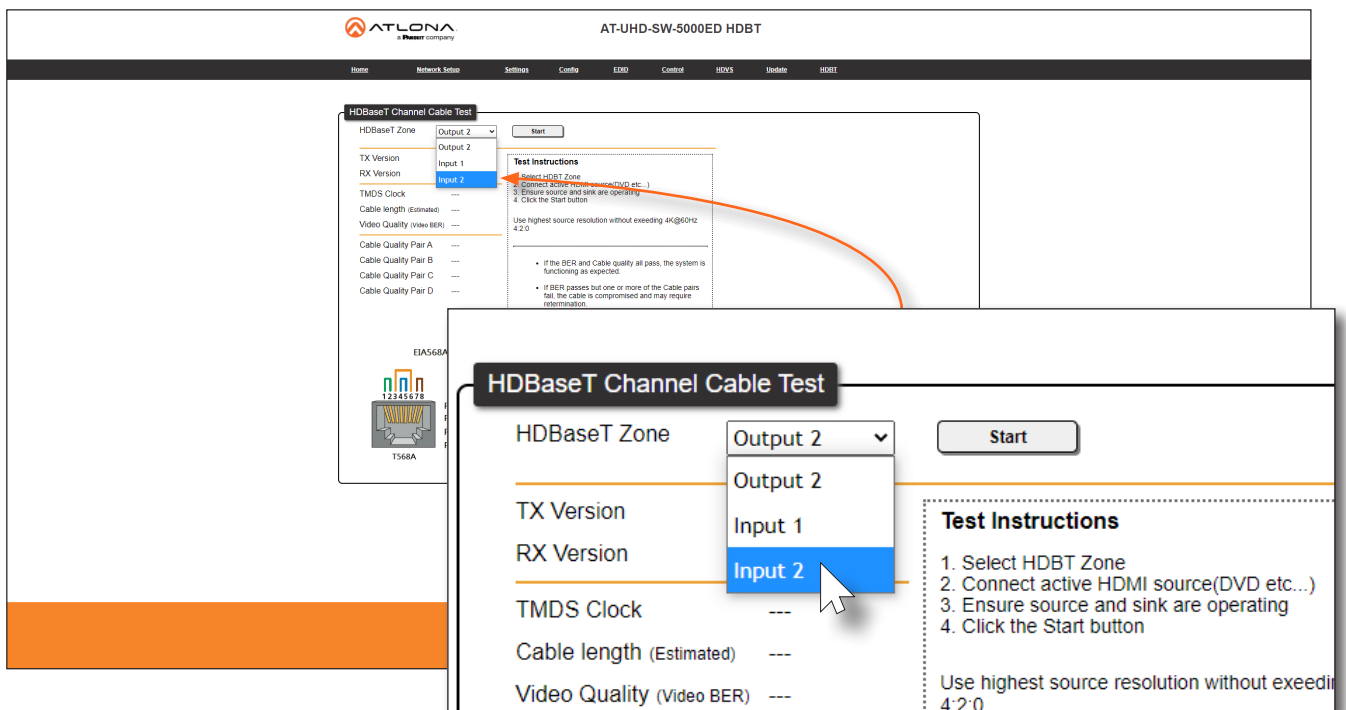

4. Click the **Start** button to begin testing the selected channel.
  - If the HDBaseT link integrity is good, then all tests will display as “Pass”.
  - If any part of the HDBaseT cable fails, then a numerical value, in decibels, will be displayed next to the associated pair, under the **Signal Quality** section. These values can be reported to Atlona Technical Support Engineers to help resolve possible issues.

## Mounting Instructions

The AT-UHD-SW-5000ED includes two mounting brackets, which can be used to attach the unit to any flat surface. Use the two enclosure screws, on the sides of the unit to attach the mounting brackets.

### Single Unit Rack Installation

1. Attach the included small rack ear to one side of the AT-UHD-SW-5000ED, using the included screws.
2. Attach the included longer rack ear to the opposite side of the AT-UHD-SW-5000ED using the included screws.

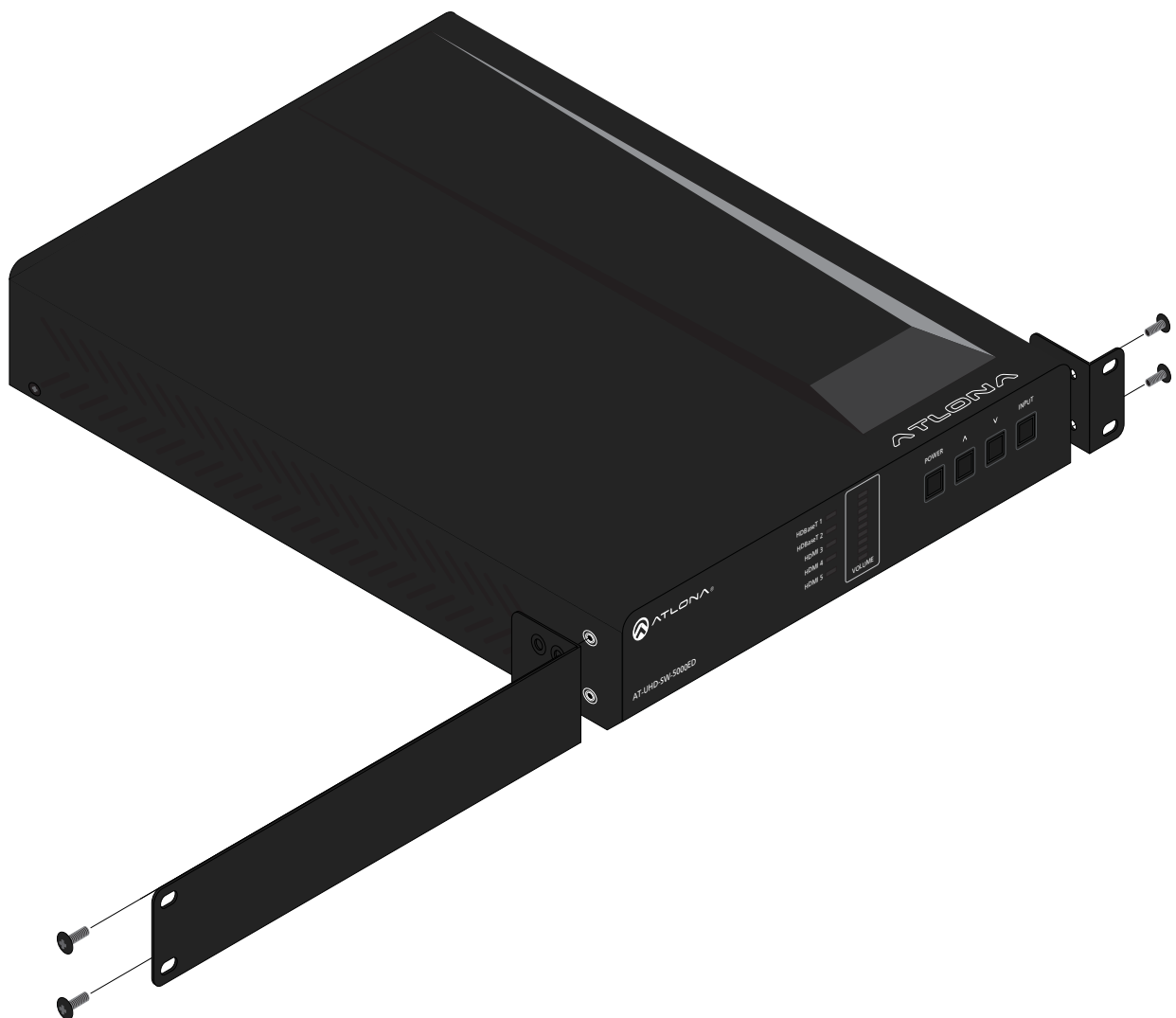



### Dual Unit Rack Installation

1. Turn both units upside-down on a flat surface, next to each other, as shown.
2. Position the included mounting plate over the pre-drilled holes on the bottom of the enclosure. When attaching the mounting plate, the countersink bevels on the mounting plate should face upward.

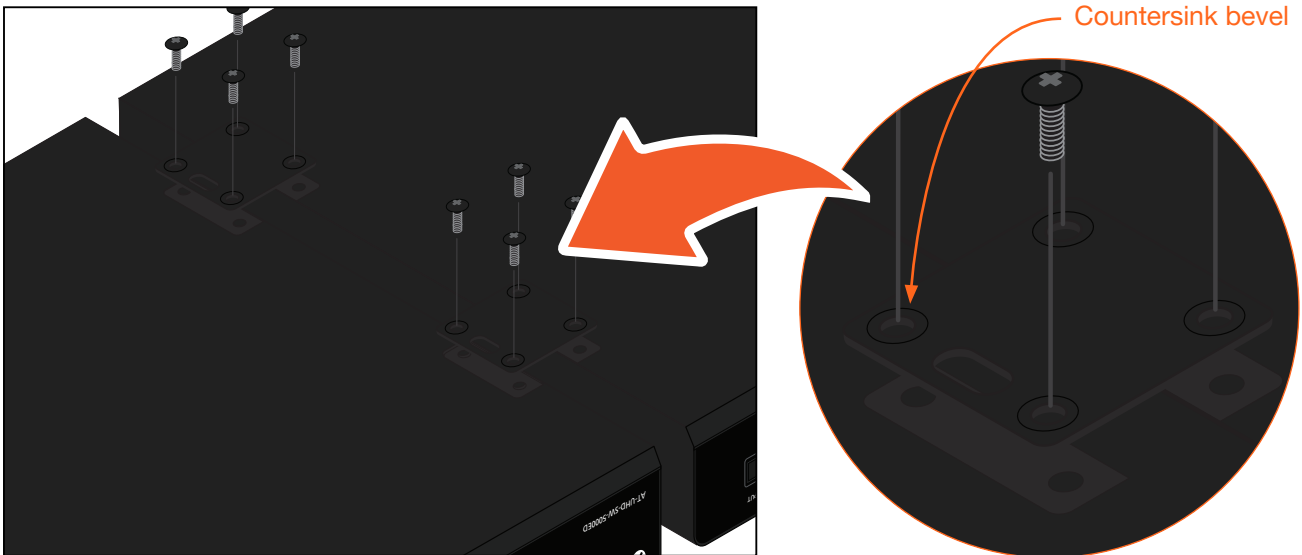

3. Turn the attached units over and install the rack ears (sold separately) to one side of each enclosure using the included screws.



### Flat Surface

1. Turn the unit upside down, on a flat surface.
2. Position the included mounting plates over the pre-drilled holes on the bottom of the enclosure. When attaching mounting plates, the countersink bevels on the mounting plates should face upward.

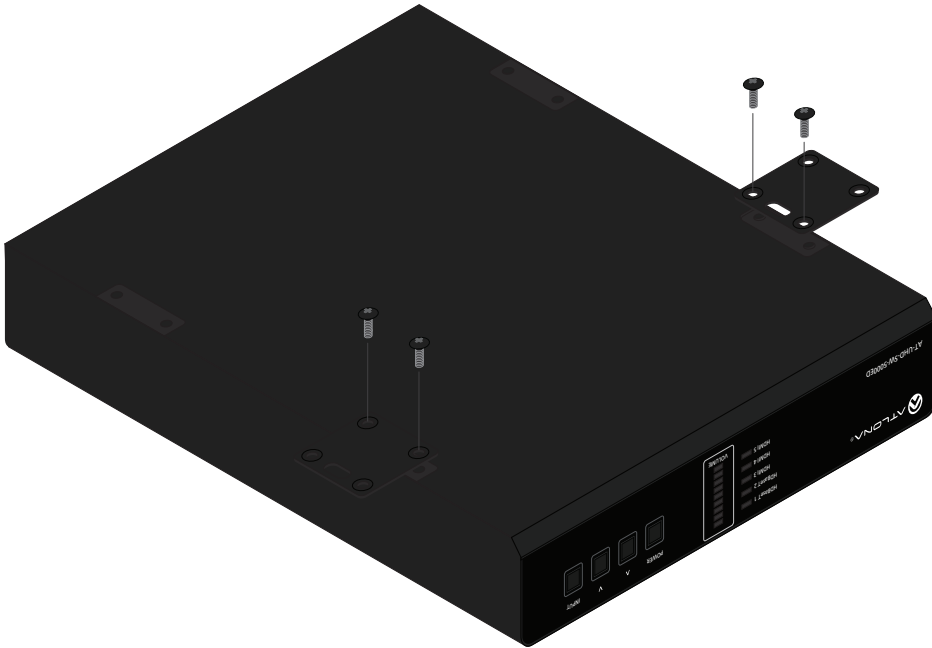

3. Mount the unit using the circular holes, on each mounting plate. If using a drywall surface, a #6 drywall screw is recommended. Mounting screws are not included.



**NOTE:** The unit can also be mounted under a flat surface, such as a table, by turning the unit upside down.

## IR Remote Control



**NOTE:** The AT-UHD-SW-5000ED no longer ships with an IR remote control. However, IR documentation remains for units currently in the field.



**IMPORTANT:** The AT-SW-R1 IR remote can be used to control the AT-UHD-SW-5000ED from a maximum distance of 15 feet (4.5 meters). Exceeding this distance may result in unreliable behavior. In addition, environmental lighting conditions, such as florecent bulbs, high-intensity light (sunlight), and other factors may also affect IR operation.

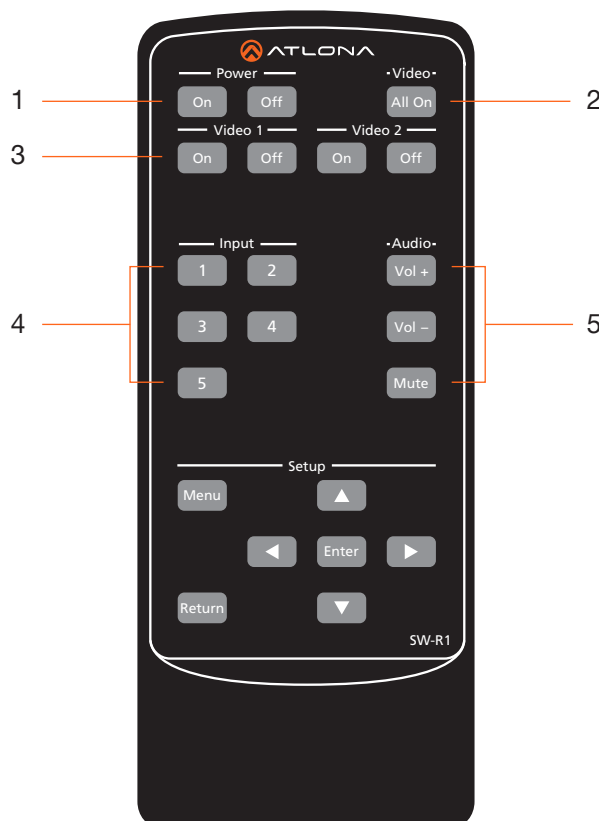

**NOTE:** The buttons under the Setup section do not function with the AT-UHD-SW-5000ED.

- |  |   |
|--|---|
| <p><b>1 Power On Off</b><br/>Press the <b>On</b> button to power on the unit or press the <b>Off</b> button to turn off the unit.</p> <p><b>2 Video All On</b><br/>Press this button to enable video output on both HDMI 1 and HDMI 2.</p> <p><b>3 Video 1 On Off / Video 2 On Off</b><br/>Press these buttons to enable or disable video output on <b>HDMI OUT</b> or <b>HDBaseT OUT</b>. Press the <b>On</b> button to enable video output. Press the <b>Off</b> button to disable video output.</p> | <p><b>4 Input</b><br/>Press these button to select the desired input.</p> <p><b>5 Audio Vol + / Vol - / Mute</b><br/>Press the <b>Vol +</b> button to increase the output volume level or press the <b>Vol -</b> button to decrease the output volume. Press the <b>Mute</b> button to mute the audio output.</p> |
|--|---|

## Specifications

Video		
Signal Type	HDMI	
HDCP	1.4	
Pixel Clock	300MHz	
UHD/HD/SD	4096×2160@60 <sup>(1)</sup> /50 <sup>(1)</sup> /30/25/24Hz 3840×2160@60 <sup>(1)</sup> /50 <sup>(1)</sup> /30/25/24Hz 2048×1080p 1920×1080p@60/59.94/50/30/29.97/25/ 24/23.98Hz 1920×1080i@60/59.94/50Hz	1280x720p@60/59.94/50Hz 720x576p 720x576i 640x480p 640x480i
VESA	2560×2048 2560×1600 2048×1536 1920×1200 1680×1050 1600×1200 1600×900 1440×900 1400×1050	1366×768 1360×768 1280×1024 1280×800 1280×768 1152×768 1024×768 800×600 640×480
Color Space	YUV, RGB	
Chroma Subsampling	4:4:4, 4:2:2, 4:2:0	
Color Depth	8-bit, 10-bit, 12-bit	

Audio			
HDMI / HDBaseT Pass-Through Formats	PCM 2.0 LPCM 5.1 LPCM 7.1	Dolby® Digital Dolby Digital Plus™ Dolby TrueHD Dolby Atmos®	DTS® Digital Surround™ DTS-HD Master Audio™ DTS:X®
S/PDIF	PCM 2.0	Dolby® Digital	DTS-HD Master Audio™
Bit Depth	Up to 24 bits		
<b>Analog Audio</b>			
Format	Maximum analog output: balanced +18dBu @ 0 dBfs, LPCM 2.0 only		
Sample Rate	32 kHz, 44.1 kHz, 48 kHz, 88.2 kHz, 96 kHz, 176.4 kHz, 192 kHz		

Control	
RS-232	Device control and configuration Bidirectional pass-through from control system over HDBaseT Supported baud rates: 2400, 4800, 9600, 19200, 38400, 57600, 115200
IP	Protocols: HTTPS, Telnet, mDNS Modes: DHCP, Static - selectable through front panel and web server
CEC Support	Yes

Resolution / Distance	4K/UHD - Feet / Meters		1080p - Feet / Meters	
HDMI IN/OUT	15	5	30	10
CAT5e	230	70	330	100
CAT6/6a/7	330	100	330	100

Buttons and Indicators	
<b>Buttons:</b> POWER, UP, DOWN, INPUT	4 - Momentary, tact-type
<b>Indicators:</b> HDBaseT 1 - HDBaseT 2, HDMI 3 - HDMI 5 VOLUME	5 - LED, blue 9 - LED, green, amber, red

Connectors	
HDMI IN	3 – Type A, 19-pin female
HDMI OUT	1 – Type A, 19-pin female
HDBaseT IN	2 - RJ45
HDBaseT OUT	1 - RJ45
LAN	1 - RJ45, 10/100 Mbps
AUDIO OUT	1 – 5-pin captive screw, balanced / unbalanced 2-channel
RS-232	1 – 3-pin captive screw (bidirectional)
IR IN/OUT	1 – 5-pin captive screw
FW	1 – Mini USB
PWR	1 - 2-pin captive screw

Temperature	Fahrenheit	Celsius
Operating	32 to 122	0 to 50
Storage	-4 to 140	-20 to 60
Humidity (RH)	20% to 60%, non-condensing	

Power	
Consumption	44.22 W
Idle Consumption	22 W
Supply	Input: 100 - 240 V AC, 50/60 Hz Output: 48 V / 3.125 A DC

Dimensions (H x W x D)	Inches	Millimeters
Unit	1.73 x 8.64 x 10	44 x 219.5 x 254
Power Supply	1.42 x 1.81 x 4.41	36 x 46 x 112

Weight	Pounds	Kilograms
Device	3.70	1.66

Certification	
Device	CE, FCC
Power Supply	CE, FCC, cULus, RoHS

(1) 4096×2160 @ 50/60 Hz and 3840×2160@50/60Hz supported @ chroma subsampling 4:2:0 8-bit only.

