



**Protea™  
4.8SP and 3.6SP  
DSP Loudspeaker System Processors**

**Operating Manual**

**ASHLY AUDIO INC.**  
847 Holt Road Webster, NY 14580-9103 Phone: (585) 872-0010  
Toll-Free: (800) 828-6308 Fax: (585) 872-0739  
ashly.com

# Important Safety Instructions

## Consignes de sécurité à lire attentivement



**CAUTION**  
Risk Of Electric Shock  
Do Not Open



The lightning flash with arrowhead symbol, within an equilateral triangle, is intended to alert the user to the presence of uninsulated "dangerous voltage" within the product's enclosure that may be of sufficient magnitude to constitute a risk of electric shock to persons. The exclamation point within an equilateral triangle is intended to alert the user to the presence of important operating and maintenance instructions in the literature accompanying the device.

Le symbole de la foudre dans un triangle équilatéral symbolisant la foudre est prévu pour sensibiliser l'utilisateur à la présence de tension de voltage non isolée à l'intérieur de l'appareil. Elle pourrait constituer un danger de risque de décharge électrique pour les utilisateurs. Le point d'exclamation dans le triangle équilatérale alerte l'utilisateur de la présence de consignes qu'il doit d'abord consulter avant d'utiliser l'appareil.

1. Read these instructions.
2. Keep these instructions.
3. Heed all warnings.
4. Follow all instructions.
5. To reduce the risk of fire or electric shock, do not expose this apparatus to rain or moisture.
6. Do not use this apparatus near water.
7. Clean only with dry cloth.
8. Do not block any ventilation openings. Install in accordance with the manufacturer's instructions.
9. Do not install near any heat sources such as radiators, heat registers, stoves, or other apparatus.
10. Do not defeat the safety purpose of the polarized or grounding-type plug. A polarized plug has two blades with one wider than the other. A grounding type plug has two blades and a third grounding prong. The wide blade or the third prong are provided for your safety. If the provided plug does not fit into your outlet, consult an electrician for replacement of the obsolete outlet.
11. Protect the power cord from being walked on or pinched particularly at plugs, convenience receptacles, and the point where they exit from the apparatus.
12. Only use attachments/accessories specified by the manufacturer.
13. Use only with the cart, stand, tripod, bracket, or table specified by the manufacturer, or sold with the apparatus. When a cart is used, use caution when moving the cart/apparatus combination to avoid injury from tip-over.
14. Unplug this apparatus during lightning storms or when unused for long periods of time.
15. Refer all servicing to qualified service personnel. Servicing is required when the apparatus has been damaged in any way, such as power-supply cord or plug is damaged, liquid has been spilled or objects have fallen into the apparatus, the apparatus has been exposed to rain or moisture, does not operate normally, or has been dropped.

1. Lisez ces instructions.
2. Conservez ces instructions.
3. Observez les avertissements.
4. Suivez ces instructions.
5. Pour réduire le risque de feu ou la décharge électrique, ne pas exposer cet appareil pour pleuvoir ou l'humidité.
6. Ne pas utiliser l'appareil près de l'eau.
7. Le nettoyer à l'aide d'un tissu sec.
8. Ne pas bloquer les ouvertures de ventilation, installer selon les consignes du fabricant.
9. Eloigner des sources de chaleur tel: radiateurs, fourneaux ou autres appareils qui produisent de la chaleur.
10. Ne pas modifier ou amputer le système de la mise à terre. Une prise avec mise à terre comprend deux lames dont une plus large ainsi qu'une mise à terre: ne pas la couper ou la modifier. Si la prise murale n'accepte pas la fiche, consulter un électricien pour qu'il remplace la prise désuète.
11. Protéger le cordon de secteur contre tous bris ou pincement qui pourraient l'endommager, soit à la fiche murale ou à l'appareil.
12. N'employer que les accessoires recommandés par le fabricant.
13. N'utiliser qu'avec les systèmes de fixation, chariots, trépied ou autres, approuvés par le fabricant ou vendus avec l'appareil.
14. Débrancher l'appareil lors des orages électriques ou si inutilisé pendant une longue période de temps.
15. Un entretien effectué par un centre de service accrédité est exigé si l'appareil a été endommagé de quelque façon: si il a été exposé à la pluie,, l'humidité ou s'il ne fonctionne pas normalement ou qu'il a été échappé.

**WARNING: THIS APPARATUS MUST BE EARTHED**

### FCC COMPLIANCE:

This device complies with part 15 of the FCC Rules for class A operation, and is subject to the following two conditions:

- 1) This device may not cause harmful interference
- 2) This device must accept any interference received, including interference that may cause undesired operation.

## Table Of Contents

<b>1</b>	<b>INTRODUCTION</b> .....	4
1.1	Audio Features .....	4
1.2	User Interface .....	4
<b>2</b>	<b>UNPACKING</b> .....	4
<b>3</b>	<b>AC POWER REQUIREMENTS</b> .....	4
<b>4</b>	<b>FRONT PANEL CONTROL FEATURES</b> .....	5
4.1	Function Keys and Data Wheel .....	5
4.2	Presets .....	5
4.3	Input Select .....	5
4.4	Output Select .....	5
4.5	LED Indicators .....	5
4.6	Audio Functions .....	6
4.6a	Gain .....	6
4.6b	EQ .....	6
4.6c	Delay .....	7
4.6d	Crossover .....	8
4.6e	Limit .....	10
4.7	Other Functions .....	10
4.7a	Recall .....	10
4.7b	Save .....	11
4.7c	Copy .....	11
4.7d	Mute .....	11
4.7e	Utilities .....	11
4.7f	Factory Reset .....	11
<b>5</b>	<b>INTERCONNECT FEATURES</b> .....	12
5.1	Audio Connections .....	12
5.2	USB Connection .....	12
5.3	RS-232 Data Connection .....	12
<b>6</b>	<b>PROTEA NE SOFTWARE</b> .....	12
<b>7</b>	<b>TROUBLESHOOTING</b> .....	14
<b>8</b>	<b>SPECIFICATIONS</b> .....	14
<b>9</b>	<b>WARRANTY INFORMATION</b> .....	15
<b>10</b>	<b>BLOCK DIAGRAM</b> .....	16

## 1. INTRODUCTION

Thank you for your purchase of this Ashly Protea 4.8SP or 3.6SP Digital Crossover/System Processor. The Protea series builds on the tradition of quality and value which has earned Ashly its place as a market leader in crossovers, equalization, and signal processing.

The 4.8SP has four inputs and eight outputs, while the 3.6SP has three inputs and six outputs. The front panel interface allows quick access to all control parameters by offering dedicated function buttons, eliminating the need for hidden sub-menus. For even faster set-ups and stronger visualization of Input/Output routing, EQ, and Filter curves, a USB port is provided for use with Windows™ Protea NE Software. Full control by third party controllers is also available via RS-232.

### 1.1 AUDIO FEATURES

The Protea 4.8SP and 3.6SP utilize state of the art DSP technologies, beginning with 24 bit, 48kHz delta-sigma A/D converters with 128x oversampling. Digital processing includes Gain, Parametric EQ, Shelving Filters, Time Delay, Crossover Functions, Compression, Limiting, and Matrix Routing, all taking place in twin 120MHz Motorola DSP56362 high performance DSP processors. D/A conversion uses 24 bit delta-sigma converters with 128x oversampling. All inputs and outputs are precision balanced and RF protected using XLR connectors.

### 1.2 USER INTERFACE

**Front Panel Interface:** A backlit 2 x 20 character LCD displays channel and function settings. Dedicated buttons provide access to all audio functions and system tools. The display indicates the current preset number, then subsequently shows the selected input or output and its active control parameters. Five segment LED arrays on each input and output provide audio level information and mute status.

**Protea NE Software:** The computer interface uses Ashly PROTEA NE SOFTWARE for Windows, which allows complete PC control of the unit through a USB jack. Protea NE software is supplied with each unit, or can be downloaded at no cost from the Ashly web site. Advantages of using the software include greater preset capacity, and a very intuitive visual representation of the audio routing and control process.

## 2. UNPACKING

As a part of our system of quality control, every Ashly product is carefully inspected before leaving the factory to ensure flawless appearance. After unpacking, please inspect for any physical damage. Save the shipping carton and all packing materials, as they were carefully designed to minimize the possibility of transportation damage should the unit again require packing and shipping. In the event that damage has occurred, immediately notify your dealer so that a written claim to cover the damages can be initiated. The right to any claim against a public carrier can be forfeited if the carrier is not notified promptly and if the shipping carton and packing materials are not available for inspection by the carrier. Save all packing materials until the claim has been settled.

## 3. AC POWER REQUIREMENTS

**Note: The AC power switch is on the back panel.** The Protea 4.8SP and 3.6SP use a universal input power supply which will accept any line voltage in the range of 100VAC to 240VAC, 50-60Hz. A standard IEC-320 grounded AC inlet is provided on the rear panel to accept the detachable power cord. **Never remove the AC earth ground connection to the unit.** In the event of fuse failure, refer the product to a qualified service technician for fuse replacement, replacing only with the same type and rating fuse.

## 4. FRONT PANEL CONTROL FEATURES

### 4.1 Function Keys and Data Wheel

To the right of the LCD display are two unlabeled function keys and a rotary data wheel. All audio and system parameters are edited using these three controls. Each of the two lines of text on the LCD display correspond to a dedicated function key, so that various tasks on both lines may be selected using their respective keys. The selected task is

highlighted by a flashing underscore beneath the word or number, and the parameter is then adjusted up or down with the data wheel. The Esc key will exit any activity and return to the top level showing the preset number and name.

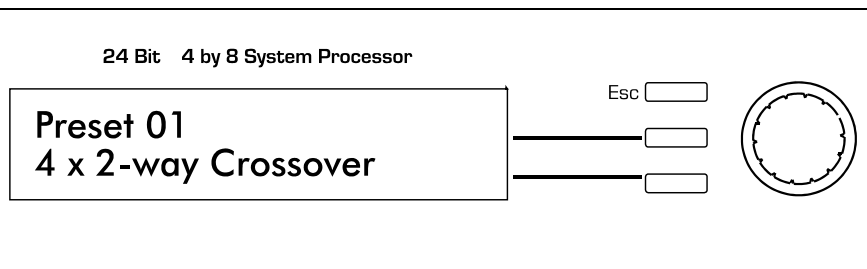

### 4.2 Presets

The 4.8SP and 3.6SP are organized into 30 programmable presets, each completely defining the configuration of all inputs and outputs along with their respective audio components. There are ten repeating preset configurations pre-loaded into the unit which are simply starting points for common applications, and all can be modified, renamed, and saved to suit the end user. **Please Note:** In addition to the 30 preset numbers, a constantly refreshed *Working Preset* is used to take a "snapshot" of all current settings should the unit be turned off before changes can be saved.

When the unit is first powered up, the last working preset is loaded, displaying the number and name last used before the unit was turned off. Any modifications made to that preset before saving it will remain in the working preset until either the modified preset is saved, or a fresh preset is recalled. When modifications to an existing preset are made without saving, the display adds the text (**modified**) after the preset number.

### 4.3 Input Select

There are four XLR audio inputs on the 4.8SP (three on the 3.6SP), and each input is processed independently and may be routed to one or several outputs. Select an input to edit its Gain, EQ, and Delay settings, or to mute it. Signal routing occurs in the output section.

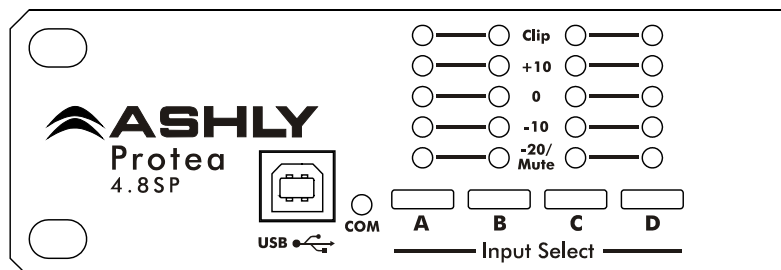

### 4.4 Output Select

There are eight outputs on the 4.8SP (six on the 3.6SP), and each output can obtain its source from any input or combination of inputs. Select an output channel to edit its Source, Gain, Polarity, EQ, Delay, Crossover, or Limiter functions.

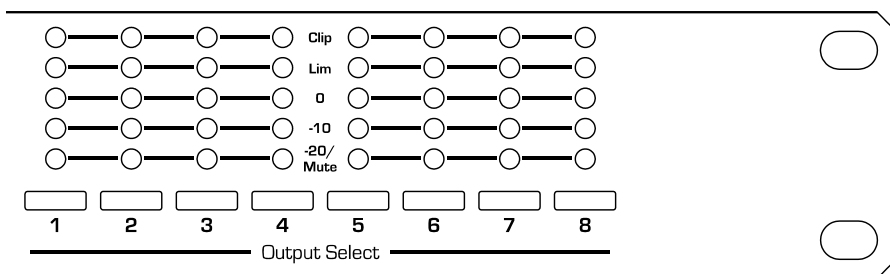

### 4.5 LED Indicators

Each input and output has a five segment LED array for audio level display, ranging from -20 through clipping. The -20 LED is two-color, also serving as the Mute indicator by turning red. The meter scale is factory set so that 0 on the meter is 0dBu (0.775Vrms), however it can be easily changed to VU scale (0 = +4dBu, or 1.228Vrms) within the Util menu.

4.6 Audio Functions

4.6a Gain

Input and Output Gain are separately adjustable from -40dB to +12dB in 0.1dB increments.

The output gain menu also provides for selection of input source(s) for a given output channel, as well as polarity of the outgoing signal. Any input or combination of inputs can be routed to any or all outputs. Keep in mind that two signals which share significant content, such as a stereo source, will be up to 6dB louder when combined.

Input Gain LCD Display



Output Gain LCD Display



4.6b EQ

The Protea SP EQ section offers full parametric EQ as well as 1st and 2nd order shelving filters on inputs and outputs. Each input channel has six selectable EQ filters, while each output channel has four selectable EQ filters. In all cases, each filter is selectable between parametric (PEQ), 1st order Low Shelf (LS1), 2nd order Low Shelf (LS2), 1st order High Shelf (HS1), and 2nd order High Shelf (HS2).

EQ LCD Display

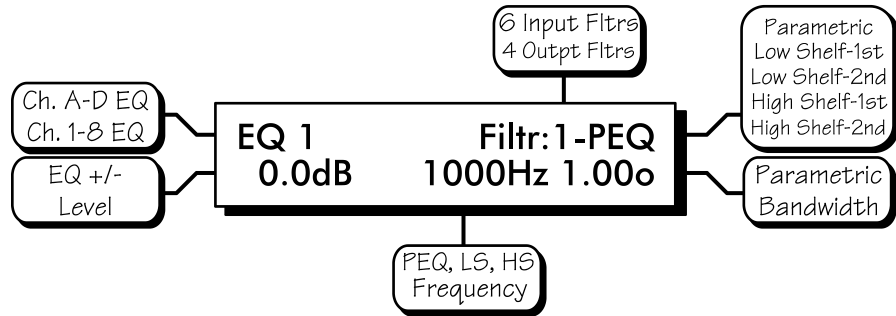

**Shelving EQ filters:** 1st order filters use a gentle 6dB per octave slope, while 2nd order filters use a 12dB per octave slope for more a pronounced boost or cut. All shelving filters have a boost/cut range of +/-15dB. Low shelving filters have a frequency range from 19.7Hz through 2kHz, and the high shelving filters range from 3.886kHz through 21.9kHz. Shelving filters are most useful as broad tone controls to boost or cut the high end or low end of an audio signal's frequency content. Because they affect a wider spectrum of audio, they are not as suitable for feedback control as parametric filters.

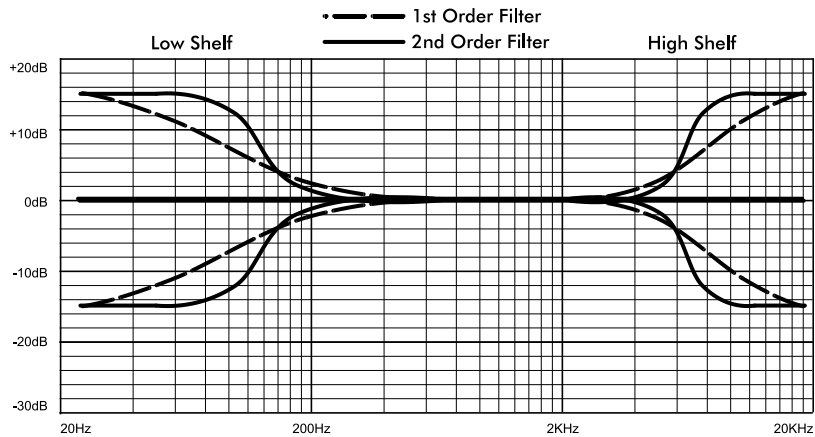

4.8SP and 3.6SP Shelving Filters

**Parametric EQ (PEQ)** uses peak filters with the ability to control boost or cut, frequency

center, and bandwidth. Think of one band of parametric EQ as a single graphic equalizer fader except that the frequency is variable, not fixed, and that the bandwidth, or how "wide" the filter affects the frequency spectrum at the center frequency, is completely variable. The smaller the bandwidth, the less the audio signal on either side of the frequency center is boost or cut,

whereas a larger "wider" bandwidth produces an audible change to the overall tone of a signal. Parametric filters are best used to hunt down and eliminate problem feedback frequencies, add or remove a characteristic "hot spot" from microphones, or clean up room resonance situations. It is well worth the time getting proficient with parametric EQ filters, as they offer the best solution to many EQ problems.

Protea SP parametric filters have a boost/cut range of +15dB to -30dB. There is more cut than boost because one of the more common uses for parametric filters is to dramatically cut, or "notch out", very narrow frequencies (low bandwidth) in order to eliminate system feedback problems.

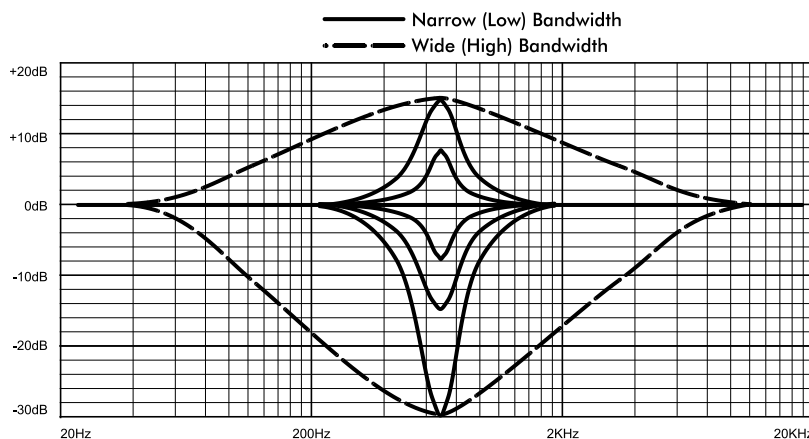

4.8SP and 3.6SP Parametric Filters

Every instance of a parametric EQ filter has a center frequency selected. The factory default is 1kHz, but each filter's center frequency is adjustable from 19.7Hz to 21.9kHz in 1/24 octave steps. Carefully sweeping a narrow bandwidth filter through a problem feedback area, with just a slight boost, is a quick way to find the exact frequency causing trouble. Once the offensive frequency has been found, cut the filter's level, and then the bandwidth is adjusted as narrow as possible while still eliminating the feedback problem. Bandwidth is adjustable from about 1/64 octave to four octaves, and the lower the bandwidth, the less audible the filter action will be. Finding the problem frequency is relatively easy, but finding the best combination of cut and bandwidth takes a little practice. Again, it is well worth the time becoming comfortable with the notching procedure, so that problems can be quickly addressed with a sufficient but minimal amount of correction.

The EQ functions on all four inputs and eight outputs are switched in or out on an individual channel basis. In other words, each input or output has one "switch" for all of its EQ filters. If certain filters are not going to be used within a channel, simply leave the gain for that filter at 0.0dB, and the filter will have no effect.

For an excellent interactive display of the way parametric and shelving filters work, experiment with the 4.8SP or 3.6SP EQ section of Protea NE Software. The software works whether a unit is connected or not, so it is an invaluable teaching tool as well as an audio setup tool for Protea products. The program is shipped with SP units, but is also available on the Ashly web site.

#### 4.6c Delay

In large installations or outdoor venues there are often many speaker clusters in various locations to get the best coverage possible. Since sound travels relatively slow through air (1130 ft/s at 20°C), multiple loudspeaker locations can create a situation where the original audio signal, simultaneously leaving all loudspeakers, arrives at a single point in the venue at several different times. Needless to say this causes problems, and what may be crystal clear sound directly in front of any one loudspeaker can be unintelligible in the farther reaches of the venue with direct line-of-sound to multiple loudspeakers. The solution is to delay the audio signal to the loudspeakers located beyond the main stage area, so that sound comes out of the distant loudspeakers at the exact time that sound from the main stage loudspeakers arrives. Within the Protea SP, up to 682 milliseconds of time delay are available, allowing secondary loudspeaker clusters to be time aligned with the primary speakers up to 771 feet (235m) away from the main stage area.

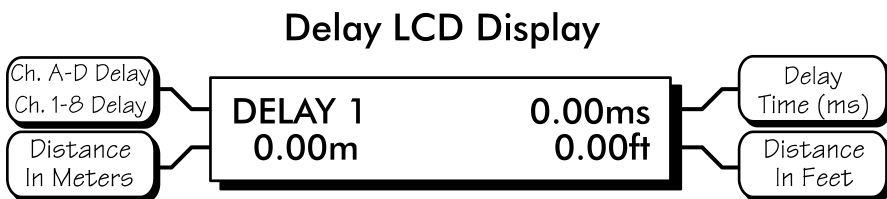

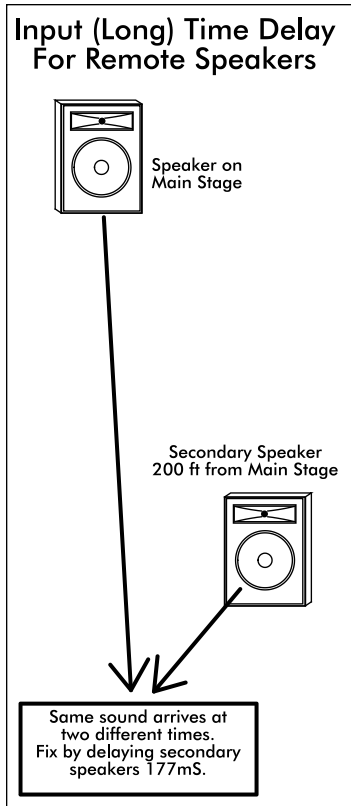

Output channels have time delay as well. Output delay is best used to align discrete drivers within a speaker cabinet or cluster, normally quite close together. For example, a typical three way speaker cluster would have low end, midrange, and high frequency drivers all located near one another. The different drivers for each frequency band are not necessarily the same physical depth with respect to the front of the loudspeaker cluster, so there exists the problem of same signals (at the crossover points) arriving at the cluster "front" at different times, creating undesirable wave interaction and frequency cancellation. The solution, again, is to slightly delay the signal to the drivers closest to the cluster front. Using the location of the driver diaphragm farthest back as a reference point, measure the distance to other drivers in the cluster, and set the output delay for each accordingly, with the driver diaphragm closest to the front getting the longest delay and the driver at the very back getting no output delay. Note: Although delay in the SP is adjusted only by time, the corresponding distance in both feet and meters is always shown as well.

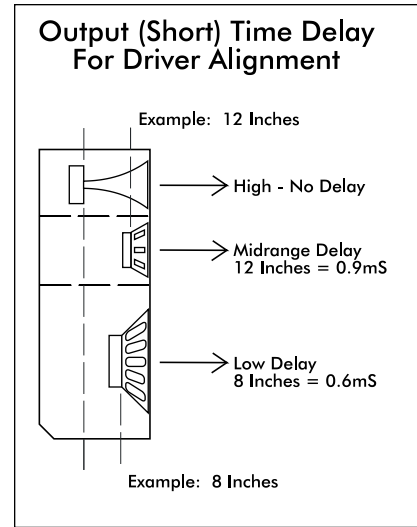

**4.6d Crossover (Xover)**

Crossover functions are available only on the output channels. Every channel's crossover consists of a high pass filter (HPF) and a low pass filter (LPF), along with the frequencies and filter types used. Each output's crossover section is essentially a bandpass filter, making it necessary for the user to map out ahead of time which outputs will be used for the various frequency bands, and set the overlapping filter frequencies and types accordingly. Note: The HPF determines the lower frequency limit of the signal, while the LPF determines the upper frequency limit.

**Crossover LCD Display**



The frequency range for the high pass filter (HPF) is from 19.7Hz to 21.9kHz, with an option to turn the filter off at the low end of the frequency selection. The low pass filter (LPF) offers the same frequency range, with the "off" option at the high end of the frequency selection.

There are 11 types of filters available in the crossover section, each suited to a specific preference or purpose. The slope of each filter type is defined by the first characters in the filter type, 12dB, 18dB, 24dB, or 48dB per octave. The steeper the slope, the more abruptly the "edges" of the pass band will drop off. There is no best filter slope for every application, so experiment to see which one sounds most pleasing in a specific system. Ashly factory default presets use all 24dB/octave Linkwitz-Riley filters in the crossover section, but of course they can be changed to suit the application.

In addition to the frequency and slope, crossover filters can be selected as having Butterworth, Bessel, or Linkwitz-Riley response. These refer to the shape of a filter's slope at the cut-off frequency, affecting the way two adjacent pass bands interact at the crossover point. 24db/octave Linkwitz-Riley filters produce a flat transition through the crossover region, assuming both overlapping filters are set to the same frequency, slope, and response type. **24dB/oct Linkwitz-Riley filters are the industry standard, the easiest to use, and the filter type recommended by Ashly.** Other filter types are available, but may require polarity switching or other adjustments for proper results. The following paragraphs offer a summary of the three filter types as used in 4.8SP and 3.6SP crossovers:



**Butterworth**

Butterworth filters individually are always -3dB at the displayed crossover frequency and are used because they have a "maximally flat" passband and sharpest transition to the stopband. When a Butterworth HPF and LPF of the same crossover frequency are summed, the combined response is always +3dB. With 12dB per octave Butterworth crossover filters, one of the outputs must be inverted or else the combined response will result in a large notch at the crossover frequency.

**Bessel**

These filters, as implemented on the SP processors, are always -3dB at the displayed crossover frequency. Bessel filters are used because they have a maximally flat group delay. Stated another way, Bessel filters have the most linear phase response. When a Bessel HPF and LPF of the same crossover frequency are summed, the combined response is +3dB for 12dB/oct, 18dB/oct, and 48dB/oct Bessel filters, and -2dB for 24dB/oct Bessel filters. One of the outputs must be inverted when using either 12dB/oct or 18dB/oct Bessel crossover filters or else the combined response will have a large notch.

**Linkwitz-Riley**

The 12 dB/oct, 24dB/oct and 48dB/oct Linkwitz-Riley filters individually are always -6dB at the displayed crossover frequency, however the 18dB/oct Linkwitz filters individually are always -3dB at the displayed crossover frequency. The reason for this is that Linkwitz-Riley filters are defined in terms of performance criterion on the summing of two adjacent crossover HPF and LPF filters, rather than defined in terms of the pole-zero characteristics of individual filters. The 18dB/oct Linkwitz-Riley individually are 18dB/oct Butterworth filters in that they have Butterworth pole-zero characteristics and also satisfy the criterion for Linkwitz-Riley filters.

When a Linkwitz-Riley HPF and LPF of the same displayed crossover frequency are summed, the combined response is always flat. With 12dB/oct Linkwitz-Riley crossover filters, one of the outputs must be inverted or else the combined response will have a large notch at the crossover frequency.

**4.6e Limit**

A full function compressor/limiter is included on each output channel. A limiter is commonly used to prevent transient audio signal spikes from damaging loudspeakers, manage analog and digital recording levels, optimize broadcast levels, or "thicken" the sound of an audio source (compression). The adjustable parameters include Limiter In/Out, Limiter Threshold, Ratio, Attack Time, and Release Time.

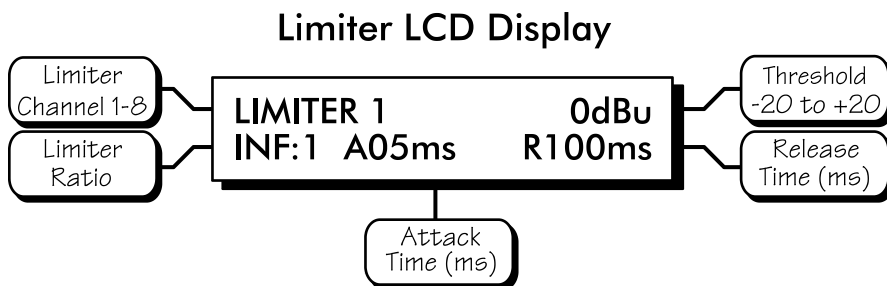

The 4.8SP and 3.6SP limiter threshold range is from -20dBu to +20dBu. This setting determines the signal level above which gain reduction begins, and is indicated by the yellow LED (Lim) in the output meter section. Increases in audio level above the threshold will be reduced according to the ratio settings.

The ratio control determines the amount of gain reduction above limiter threshold. Ratio ranges from a gentle 1.2:1 to a brick-wall INF:1. To illustrate how the ratio control works, imagine a commonly used loudspeaker protection ratio of 10:1, which means that for every input signal increase of 10 dB above threshold, the output level will only increase by 1dB. The higher the ratio, the more pronounced the audio effect, so use the lowest ratio possible to sufficiently address the problem.

Attack (A\_\_ms) and Release (R\_\_ms) settings adjust the time it takes the limiter to engage and then disengage when the signal increases above threshold and then subsequently falls back below threshold. Attack time is adjustable from 0.5ms through 50ms, while release time ranges from 10ms through 1s. A very fast attack time can sound unnatural, while a very long attack time can miss some of the initial transient. Similarly, a very short release time can make the audio sound uneven, while a very long release time can create "pumping", or "breathing" characteristics depending on the kind of signal. Experiment to find the best solution for a given application.

## 4.7 Other Functions

The Protea 4.8SP and 3.6SP have a full complement of non-audio functions within a single keystroke to navigate around the product quickly. Recall, Save, Copy, Mute, and a Utilities menu complete the user friendly interface Protea products are known for.

### 4.7a Recall

There are 30 stored presets which can be recalled on the SP processor. Note: A preset recall will overwrite the working settings, so make sure the current configuration is saved before continuing or it will be lost. Remember, an unsaved working preset shows (**modified**) on the preset name screen. Press Esc to see the preset name screen. The unit always loads the working preset on power-up, so as to preserve any changes should the power be inadvertently turned off prior to saving.

Ashly has included ten preset templates as starting points for common 4.8SP or 3.6SP configurations, and these preset templates repeat as they scroll through the 30 presets. To recall a new preset, press the recall button once, select the desired preset number, and press recall again. At this point the LCD display prompts the user to mute the outputs or not, and selecting Yes or No will load the new preset and mute all outputs if so desired. *A new preset may have dramatically different settings capable of damaging sound system components, so be careful not to recall the wrong preset while the system is on.* To be safe, always select "Yes" to mute all outputs.

### 4.7b Save

Once the unit has been adjusted to suit the application, the changes can be permanently saved to memory\*. To save a new configuration or save changes to an existing preset template, begin the process by pressing the Save button once. The LCD display prompts for the new (or same) preset number, and after selecting the desired number press Save again. At this point the name of the preset can be changed by selecting any one of the 20 text characters and scrolling through the list of 89 available ASCII characters for each. Pressing the Save button again permanently stores the working preset to the new preset location.

*\*Note: performing a Factory Reset will erase all user presets and replace them with the ten original Ashly preset templates. User defined presets can be stored off-line as files using Protea NE Software.*

### 4.7c Copy

The Copy function is used to quickly transfer all settings from a currently selected input or output to another input or output channel. An example of how this might be used is with stage monitors. Suppose there are eight monitor mixes on stage, and they all use the same type of floor wedge. The first monitor could be set up with Gain, EQ, and Limiting, then those settings could be quickly copied to the remaining seven monitors, providing a consistent starting point for each mix. To copy, first select the input/output to copy from, then press the Copy button, then press the input/output to copy to, pressing the Copy button a second time to complete the action.

### 4.7d Mute

The Protea 4.8SP and 3.6SP allow the user to mute both inputs and/or outputs. When muted, an input or output's red Mute LED is lit. When an input or output is selected, pressing the Mute button will toggle its mute function. To quickly mute all outputs, escape out to the top level preset display, then press the Mute button, pressing it a second time to confirm. Additionally, when recalling a new preset number to the unit, the LCD display prompts the user to mute all outputs, as a new preset can introduce dramatic changes to the system configuration.

#### 4.7e Util

The Protea 4.8SP and 3.6SP utilities include a security section for password protected lockout, a dBu/VU meter preference select, and a device name display.

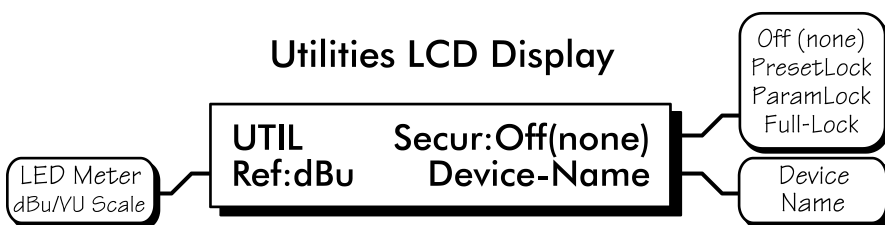

#### Security

There are four security modes in the 4.8SP and 3.6SP: Off, Preset Lock, Parameter Lock, and Full Lockout. When connected to a PC via the USB port, security settings made on the SP unit are read and used within the Protea NE software security section, sharing the same passcode.

- 1.) Off (none) allows full access to all controls.
- 2.) Preset Lock allows full access while disabling the save function.
- 3.) Parameter Lock allows the user to recall different presets, but allows no changes other than mute.
- 4.) Full Lockout allows absolutely no local changes, but allows viewing of current settings.

To access the security menu, first press the Util button, then select the Security display line on the LCD. Use the data wheel to select from the four security levels. If the unit is brand new and has never had a security code, or has had a factory reset, a four digit code must first be entered before changing security status. Use the output select buttons 1-8 (recommended) or the data wheel (0-9) to enter a new code, then press Enter on the LCD. The LCD then prompts the user to either change the code to a new four digit number, or change the Security status to one of the other three options.

The only way to fully remove a security code once it has been entered is with a factory reset. This is done by turning the power on while pressing Esc and Recall together, returning all settings, **including user defined presets**, to their original factory settings. *Note: In the event the four digit security code is forgotten, turn the unit on while pressing both the Esc and Util buttons.*

#### dBu/VU Meter Select

The input and output meter scale is factory set so that a green LED flashing at 0 indicates a signal level of 0dBu, or 0.775Vrms. To change this to a VU scale, where 0VU = +4dBu (1.228Vrms), select the <Ref:> option in the Util menu to VU. *Note: Protea NE software for the 4.8SP and 3.6SP can only display LED meters in dBu.*

#### Device Name

The device name is assigned from within Protea NE software, and is displayed in the LCD window.

#### 4.7f Factory Reset

To clear all preset names, reset all controls to their original factory settings, and delete the password from memory, Factory Reset may be performed by *simultaneously pressing and holding Esc and Recall* while switching power on. **Caution: doing this will erase all user-defined presets!**

## 5. INTERCONNECT FEATURES

### 5.1 Audio Connections

All Protea audio connections use three pin XLR jacks, with pin 2 (+), pin 3 (-), and pin 1(G). Inputs and outputs are electronically precision balanced. If an unbalanced signal is fed to an input, the signal should be on the (+) connection (pin 2) and pin 3 must be tied to ground, or significant signal loss will result. In other words, never float pin 2 or pin 3. It is strongly recommended that balanced signals be used whenever possible.

#### *A Note About Input Signal Levels:*

*There are no analog gain trim adjustments on the Protea SP unit, therefore all the processing (including gain) is done in the digital domain. As a consequence of this design philosophy, it is important to feed the Protea processor with the proper nominal signal level to achieve good signal to noise performance as well as headroom before clipping. This unit is designed to clip at signal levels above +20dBu (7.75Vrms), which places the noise floor lower than -92dBu. The optimum input signal level which should be fed into the Protea processor is 0dBu = .775Vrms. This input level will allow 20dB of headroom while giving a nominal signal that is >92dB above the noise floor.*

### 5.2 USB Connection

There are two USB ports on the SP unit, one on the front and one on the back panel. They both serve the same function, but a front panel USB connection will always override the back panel USB port if both are being used simultaneously. A six foot USB-A to USB-B cable is provided with every Protea SP unit to connect to a computer running Ashly Protea NE software.

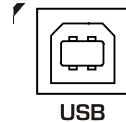

### 5.3 RS-232 Data Connections

Several third party controllers use RS-232 for control of other devices which may include the Protea SP processors. For detailed information regarding the implementation of RS-232 control, contact the Ashly service department. *Note: Protea NE software will not work with a 4.8SP or 3.6SP processor using RS-232. The computer connection must use a USB port.*

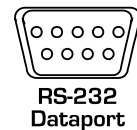

## 6. PROTEA NE SOFTWARE

### **Loading the software**

Ashly Protea NE software is included on a CD with each unit. Check the Ashly web site at [www.ashly.com](http://www.ashly.com) to verify that you are installing the latest software release. Autorun will launch the application <ProteaSystemSoftwareNE> to install the Protea software.

### **Connect the SP processor**

The control connection is made using a standard USB-A to USB-B cable, provided by Ashly with each unit.

### **Identify the processor in software**

Once the software is loaded to the computer and the data connection has been made to the 4.8SP or 3.6SP, all installed NE software compatible Ashly products will be automatically detected and shown in the active device listing on the left side of the Protea NE software startup canvas. *Note: In the event of multiple processors of the same model on the network, the user can find a single physical unit by right clicking over the unit's name in the drop down menu, and then click <Identify>, which will flash the Com LED on that unit's face panel for two seconds.*

The software scans for active devices on power-up, but the user can manually scan at any time as well with <Scan For Devices> at the bottom of the network device listing. All Ashly devices continuously broadcast their availability to the software. All currently connected and active products are highlighted in green, while units which may be or have been formerly installed but are currently off-line or unavailable show up in red. Individual products can be dragged onto the project canvas to simulate physical rack installation groups, but editing each product can be done from either the product list or the image on the canvas.

### **The NE software project canvas**

The project canvas is used to visually represent and control a fixed physical sound system installation, and can display any of the Ashly processors, amplifiers, and remotes used in that system. The user can also place an assortment of isolated control objects such as level faders, single LEDs, meter bars, etc, and map them to specific product functions within that project. Once a control object is placed, right click on it to bring up its properties. Additionally, lines, rectangles, text, and even image files can be added to create a custom virtual control screen along with the Ashly products and individual control objects. To see all available canvas tools, right click anywhere over open canvas. Checking <Design Mode> allows placed objects to be moved around, while unchecking <Design Mode> locks objects in place

### **Meters**

Inputs and outputs each have real-time virtual meter displays, shown in dBu only. Output compressor/limiters have meter displays shown in dB.

### **Presets Options**

The 4.8SP or 3.6SP will store up to 30 total presets. A preset file takes a “snapshot” of all current settings and stores complete control data for all channels and all audio functions. In addition to pressing the Save button on the face panel, individual presets can be saved to the processor by using <Preset Options/Save Preset To Protea>, or saved to a PC using <Preset Options/Save To Disk>. Preset files for Ashly SP products use the extension (\*.pne).

In addition to the face panel preset recall button, a preset can be recalled in software from either a computer or from the processor’s internal memory. *Caution: A new preset may have dramatically different settings capable of damaging sound system components, so be careful not to recall the wrong preset while the system is on.*

The Protea 4.8SP and 3.6SP are similar to the older Ashly Protea 4.24C and 3.24CL models respectively. An existing preset file from the older \*.pcc format can be loaded onto the new SP unit using <Preset Options/Load 4.24C Preset From Disk>.

### **Security**

The 4.8SP and 3.6SP processors have front panel security options within the utilities menu. Additionally, Protea NE software offers independent management of the front panel security as well as software security. The password will be the same in software as it is on the physical unit.

## 7. TROUBLESHOOTING

### 7.1 - Audio Troubleshooting Tips

**No power** - Is the detachable AC cord fully plugged in? Is the rear panel power switch on?

**Controls don't work** - check the Security Level. If set to Full Lockout, then Protea unit is "view only". Change security settings in Util menu or software.

**No sound** - Check to see if the input or output is muted. Is the input or output Gain turned down? Check the selected audio source(s) for each output, making sure there is signal applied to the designated input(s). If the crossover is used, make sure the high pass filter (HPF) is set to a lower frequency than the low pass filter (LPF).

**Clip light stays on** - Is the input signal level too high? Check to see that the nominal input level is 0dBu, allowing 20dB of input headroom. Are input or output gain settings too high? Check to see if an EQ filter has too much boost.

**Distorted sound but no Clip LED**- Check individual EQ filters to see if there is excessive boost.

**Muffled sound** - If expecting full range audio on an output, make sure the crossover settings are not inadvertently set so as to limit the pass band.

**Excessive Noise** - An input signal level or an input gain setting that is too low could require the loss to be made up for at the output gain stage, producing more noise than a properly set up gain structure. Do not use the DSP processor section for dramatic increases in level, but rather optimize the signal source for a nominal 0dBu output.

**Forgot the password** - See section 4.7e

## 8. SPECIFICATIONS

**Input** ..... Active Balanced, 18kΩ, RF Filtered  
**Max. Input Level** ..... +20dBu  
**Input Gain Range** ..... -40dB to +12dB

**Output** ..... Active Balanced, 112Ω, RF Filtered  
**Max. Output Level** ..... +20dBu  
**Output Gain Range** ..... -40dB to +12dB

**Frequency Response** ..... 20Hz to 20kHz, ±0.25dB  
**THD + N** ..... < 0.002% @ +4dBu, 1kHz  
**Dynamic Range** ..... > 112dB, 20Hz - 20kHz unweighted  
**Crosstalk** ..... < -90dB  
**Audio Sampling Rate** ..... 48kHz  
**Propagation Delay** ..... 1.46mS

**EQ**  
**EQ Filter Types** ..... 1st or 2nd Order High or Low Shelf, Parametric  
**Shelving Filter Boost/Cut Range** ..... ±15dB  
**Shelving Filter Frequency Range** ..... Low Shelf 19.7Hz to 2kHz, High Shelf 3.8kHz to 21.9kHz  
**Parametric Filter Boost/Cut Range** ..... +15dB/-30dB  
**Parametric Filter Frequency Range** ..... 19.7Hz to 21.9kHz, 1/24 Octave Steps  
**Parametric Filter Bandwidth** ..... Four Octaves to 1/64 Octave

**Input and Output Delay** ..... 0-682 milliseconds

**Crossover**

**HPF and LPF Frequency Range** . . . . . 19.7Hz to 21.9kHz, Off  
**Available Filter Types** . . . . . 12dB/Oct Butterworth, 12dB/Oct Bessel, 12dB/Oct Linkwitz-Riley  
18dB/Oct Bessel, 18dB/Oct Linkwitz-Riley  
24dB/Oct Butterworth, 24dB/Oct Bessel, 24dB/Oct Linkwitz-Riley  
48dB/Oct Butterworth, 48dB/Oct Bessel, 48dB/Oct Linkwitz-Riley

**Limiter**

**Threshold Range** . . . . . -20dBu to +20dBu  
**Ratio Range** . . . . . 1.2:1 to INF:1  
**Attack Time Range** . . . . . 0.5ms to 50ms  
**Release Time Range** . . . . . 10ms to 1 Second

**Signal LEDs & Clip** . . . . . Inputs: -20/Mute, -10, 0, +10, Clip (dBu or VU)  
Outputs: -20/Mute, -10, 0, Limit Threshold, Clip (dBu or VU)

**AC Requirements** . . . . . Universal Power Supply, 100-240VAC, 50/60Hz, 20W max

**Environmental** . . . . . 40°F - 120°F (4°C-49°C) Non-condensing

**Unit Weight** . . . . . 7.0 lbs (3.18kg)

**Shipping Weight** . . . . . 9.5 lbs (4.33kg)

**Dimensions** . . . . . 19.0" L x 1.75" H x 8.5" D (48.3 cm x 8.9 cm x 21.6 cm)

## 9. ASHLY AUDIO INC Limited Warranty (USA ONLY)

(Other countries please contact your respective distributor or dealer)

**For units purchased in the USA**, warranty service for this unit shall be provided by ASHLY AUDIO, INC. in accordance with the following warranty statement:

ASHLY AUDIO, INC. warrants to the owner of this product that it will be free from defects in workmanship and materials for a period of FIVE years from the original date of purchase. ASHLY AUDIO INC. will without charge, repair or replace at its discretion any defective product or component parts upon prepaid delivery of the product to the ASHLY AUDIO, INC. factory service department, accompanied with a proof of original date of purchase in the form of a valid sales receipt. This warranty gives you specific legal rights, and you may also have other rights, which vary from state to state.

**EXCLUSIONS:** This warranty does not apply in the event of misuse, neglect or as a result of unauthorized alterations or repairs made to the product. This warranty is void if the serial number is altered, defaced, or removed. ASHLY AUDIO reserves the right to make changes in design, or make additions to, or improvements upon this product, without any obligation to install the same on products previously manufactured.

Any implied warranties which may arise under the operation of state law shall be effective only for FIVE years from the original date of purchase of the product. ASHLY AUDIO, INC. shall be obligated to only correct defects in the product itself. ASHLY AUDIO, INC. is not liable for any damage or injury which may result from or be incidental to or a consequence of such defect. Some states do not allow limitations on how long an implied warranty lasts, or the exclusion, or limitation of incidental or consequential damages, so the above limitations or exclusions may not apply to you.

### OBTAINING WARRANTY SERVICE:

**For warranty service in the United States, please follow this procedure:**

1) Return the product to ASHLY AUDIO, INC, freight prepaid, with a written statement describing the defect and application that the product is used in. ASHLY AUDIO, INC. will examine the product and perform any necessary service, including replacement of defective parts, at no further cost to you.

2) Ship your product to:

Ashly Audio Inc.  
Attn: Service Department  
847 Holt Road  
Webster, NY 14580-9103

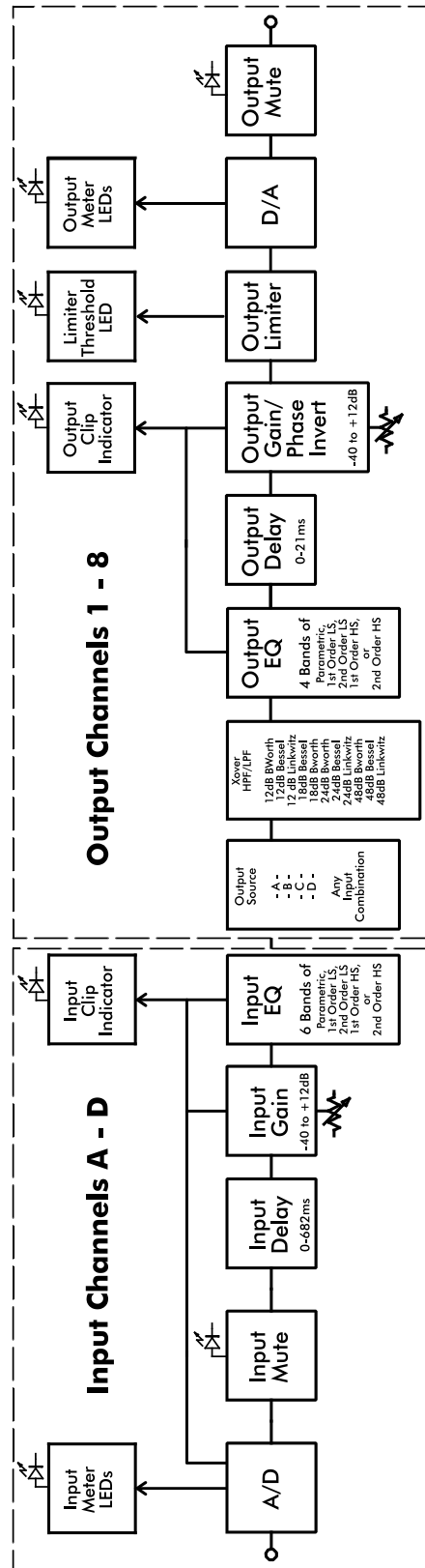
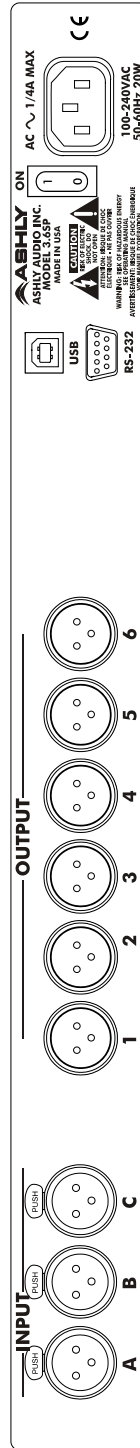
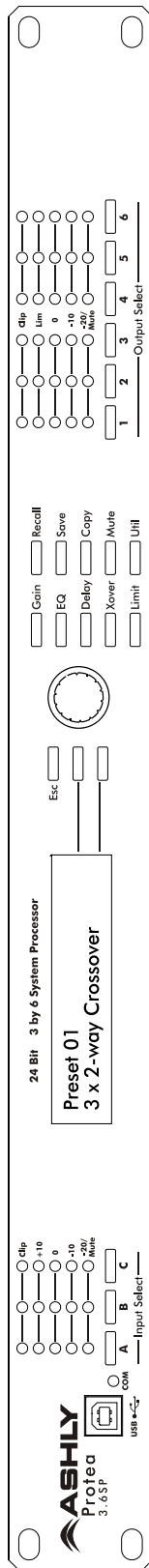
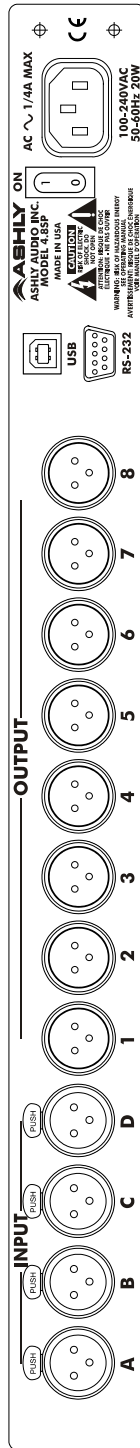
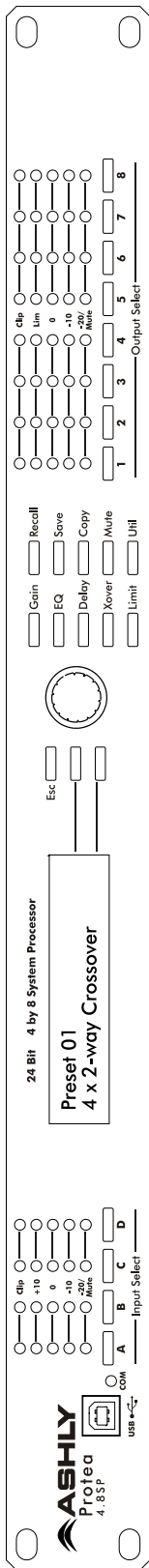

ASHLY AUDIO INC. 847 Holt Road Webster, NY 14580-9103, USA

Phone: (585) 872-0010 Fax: (585) 872-0739

Toll Free (800) 828-6308 ashly.com

©2014 by Ashly Audio Corporation, a division of Jam Industries Ltd. All rights reserved worldwide.

All features, specifications, and graphical representations are subject to change or improvement without notice.