

VZ-UNBS SERIES

49" and 55" PROFESSIONAL

LED CCTV VIDEO WALL MONITOR **USER MANUAL**

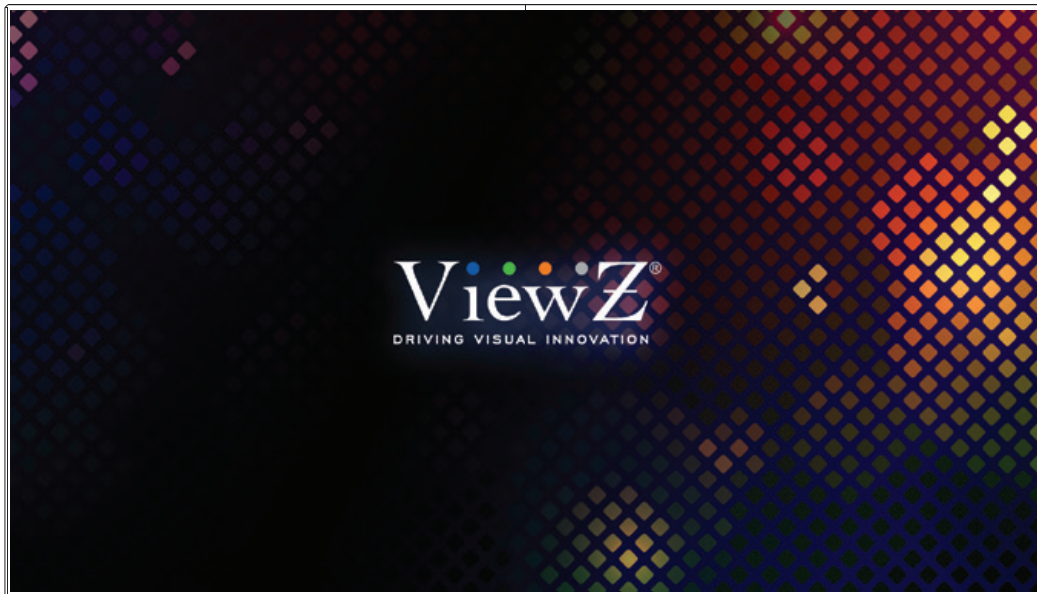

ViewZ[®]
www.viewzusa.com

Please read this manual thoroughly before use, and keep it handy for future reference.

CONTENTS

Safety Instruction	3
1. Mark Indication & Substance	4
2. Warning & Caution	4
3. FCC RF INTERFERENCE STATEMENT	6
Installation	7
1. Features	8
2. Interface, Resolution & Refresh Rate	9
Function	10
1. Remote Control Function	10
2. OSD Control and Function	11
Setup Daisy Chain	18
RS232 (RJ-45) Pin Map	24
RS232 Command	25
Mounting Guide	29
Specification	30
Trouble Shooting	31
RMA	32
Warranty	36

SAFETY INSTRUCTIONS

Important Safety Instructions

1. **Read all warnings.**
2. Follow all instructions to ensure longevity of monitor.
3. Do not place the monitor near water.
4. Clean only with dry cloth.
5. Do not block any ventilation openings. Install in accordance with the manufacturer's instructions.
6. Do not install near any heat sources such as radiators, heat registers, stoves, or other heat generating devices.
7. Do not override the safety purpose of the polarized or grounding-type plug.
8. A polarized plug has two blades with one wider than the other.
9. A grounding type plug has two blades and a third grounding prong.
10. The wide blade or the third prong is provided for your safety.
11. If the provided plug does not fit into your outlet, consult with electrician for replacement of the outlet.
12. Protect the power cord from being walked on or pinched particularly at plugs, convenience receptacles and the point where it connects to the monitor.
13. Only use attachment/accessories specified by the manufacturer.
14. Use only with the cart, stand, tripod, bracket or table specified by the manufacturer or sold with the monitor. When a cart is used, use caution when moving the cart & monitor in combination to avoid injuries.
15. Unplug the monitor during lightning storms or when unused for long periods of time.
16. Refer all servicing to qualified service personnel. Servicing is required when the monitor has been damaged in any way.



The monitor shall not be exposed to dripping or splashing and objects containing liquids such as vases shall be placed near the monitor.

The monitor should have ample distance (e.g. 10cm) from the wall for sufficient ventilation.

SAFETY INSTRUCTIONS

Important Safety Instructions

Mark Indication and Substance



CAUTION : TO REDUCE THE RISK OF ELECTRICAL SHOCK,
DO NOT REMOVE COVER (OR BACK). NO USER
SERVICEABLE PARTS INSIDE. REFER SERVICING TO
QUALIFIED SERVICE PERSONNEL



This symbol is intended to alert the user to the presence of uninsulated & dangerous voltage within the monitor's enclosure that may be of sufficient magnitude to constitute a risk of electric shock to persons.



This symbol is intended to alert the user to the presence of important operating and maintenance (servicing) instructions in the literature accompanying the monitor.

Warning

- Do not use damaged or loose cables and plug.
- Do not pull the plug out by the wire nor touch the plug with wet hands.
- Use only a properly grounded plug and receptacle.
- Do not connect too many extension cords or plugs to one outlet.
- Do not excessively bend the plug and wire.
- Do not disconnect the power cord while it's still plugged into the monitor.
- Do not place any heavy objects on the power cord. Damage to the cord may cause shock or fire.
- Never open the monitor. There are no user-serviceable parts inside and opening will void warranty.
- Removing covers may expose you to dangerous shock hazards or other risks.
- Keep any heating devices away from the power cable and monitor.
- Do not place the monitor near water.
- Do not insert objects of any kind into the monitor's open slots, as they may touch dangerous voltage points.
- Please follow the laws and regulations of your municipality to dispose the monitor properly.
- Do not use the monitor in high temperature, humid, dusty or oily areas.
- Do not install the monitor where it will be exposed to continual vibration.
- Keep the plastic packaging out of children's reach.
- If any damage is detected upon first opening the box, contact agency from which you bought the monitor directly.
- If your monitor does not operate normally – in particular, if there is any unusual sound or smell coming from the monitor – unplug it immediately and contact an authorized dealer or the service center.

SAFETY INSTRUCTIONS

Important Safety Instructions

Caution

- If the connector between the plug and the pin is dusty or dirty, clean it properly using a dry cloth.
- Make sure to unplug the power cord before cleaning the monitor.
- Make sure to leave a gap between monitor and wall.
- Do not drop the monitor when moving it.
- Place your monitor in a location with low humidity and minimal dust.
- Install the monitor base on a showcase or shelf so that the end of the base does not protrude from the showcase or shelf.
- Do not place the monitor on an unstable or small surface area.
- Do not install inside a vehicle.
- Disconnect the plug from the outlet during storms or lightning or if it has not been used for a long time.
- Do not try to move the monitor by pulling on the power cord.
- Do not cover the vents on the monitor.
- When moving the monitor, turn off and unplug the power cord. Make sure that all cables, including HDMI cable and cables connected to other devices, are disconnected before moving it.
- Place the monitor out of children's reach as they could damage it by hanging onto it.

Available Temperature & Humidity

- Operating Temperature : 5°F ~ 149°F / -15°C ~ 65°C
- Operating Humidity : 5 ~ 95% RH

Dot Defect (dead pixel) of TFT

ViewZ monitors are manufactured using high-end semiconductor technology with precision ratings of 99.9% and above. However, it may be the case that certain RGB and white pixels seem darker (or entirely unlit i.e. black).

Modern production methods cannot guarantee an absolute fault-free monitor. To this effect, no LED manufacturer can guarantee a defect free panel. A few isolated pixel or sub-pixel faults are considered tolerable and different policies exist that govern the amount of these tolerable values.

While most pixel faults occur in isolated regions, a cluster of dead pixels or sub-pixels can sometimes form for which a separate ruling applies. A cluster is defined as an area of 5x5 pixels. ViewZ's policy on pixel failure: either as an isolated fault or in the form of a cluster is outlined on the website: www.viewzusa.com

FCC RF INTERFERENCE STATEMENT

Note

This equipment has been tested and found to comply with the limits for a Class A digital device, pursuant to part 15 of the FCC Rules. These limits are designed to provide reasonable protection against harmful interference when the equipment is operated in a commercial environment.

This equipment generates, uses, and can radiate radio frequency energy and, if not installed and used in accordance with the instruction manual, may cause harmful interference to radio communications. Operation of this equipment in a residential area is likely to cause harmful interference in which case the user will be required to correct the interference at his own expense.

- Reorient or relocate the receiving antenna.
- Increase the separation between the equipment and receiver.
- Connect the equipment into an outlet on a circuit different from that to which the receiver is connected.
- Consult the dealer or an experienced radio, TV technician for help.
- Only shielded interface cable should be used.

Finally, any changes or modifications to the equipment by the user not expressly approved by the grantee or manufacturer could void the users authority to operate such equipment.

Statement

- VGA and XGA are the registered trademark of IBM.
- VESA is the trademark of Video Electronics Standard Association.
- HDMI, HDMI logo and High-Definition Multimedia Interface (high definition multimedia digital interface) are the trademark or registered trademark of HDMI Licensing LLC.

If some company or product trademark is not particularly stated, the use of trademark has been fully recognized. Do not alter, decompile, disassemble, decode or conduct reverse engineering to the software installed in the product, or it can be deemed as breach of the law.

INSTALLATION

Installation Tools

The following tools may be required or recommended.

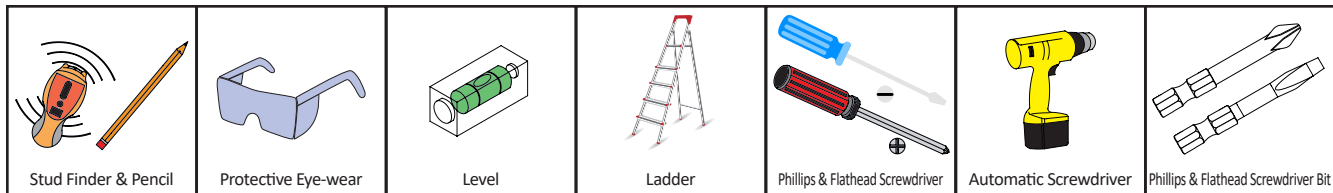

Assembly Components - provided

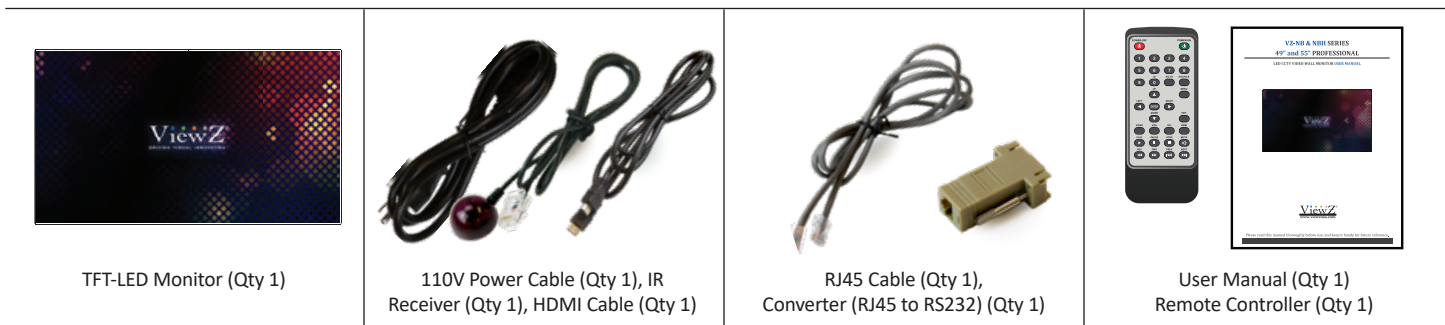

Your ViewZ monitor is shipped with all proper installation hardware and components. If there are parts missing and/or damaged, please stop the installation and contact ViewZ USA at (888)-998-4399.





Mounting Options

Your ViewZ monitor is compatible with ViewZ monitor mounts. For more information, please contact ViewZ USA at (888)-998-4399.

Wall Mount

- | | |
|--|--|
| <ul style="list-style-type: none"> Part # VZ-WM71 Tilting $-10^{\circ} \sim 0^{\circ}$ Universal Mount Load Capacity
165 lbs / 75 kg  | <ul style="list-style-type: none"> Part # VZ-XMS Tilting Hor. $\pm 3^{\circ}$ Ver. $- 2^{\circ} \sim +4^{\circ}$ Universal Mount Load Capacity
154 lbs / 70 kg  |
|--|--|

Ceiling Mount

- | | |
|--|---|
| <ul style="list-style-type: none"> Part # VZ-CMKIT-04 Tilting $-12^{\circ} \sim +5^{\circ}$ Rotation 360° Universal Mount Load Capacity
110 lbs / 50 kg  | <ul style="list-style-type: none"> Part # VZ-FSM2x2 Tilting $\pm 4^{\circ}$ Universal Mount Load Capacity
110 lbs / 50 kg  |
|--|---|

FEATURES

Features

- Creates a seamless display effect in multi-screen splicing
- Supports m rows and n columns ($1 \leq m \leq 15$, $1 \leq n \leq 15$) in splicing and 15 x15 at most
- Remote control of RS232 serial port: each unit supports one RS232 input and loop-out
- Integrated multi-channel video signal type - HDMI, DVI, VGA, DP, video daisy-chained by HDMI up to 15x15.
- Auto color adjustment guarantees color uniformity in multi-screen splicing with a built-in control unit to make the best adjustment of color
- The built-in picture cutting and compensation function can work with system software to accommodate large screen splicing project
- Industrial cooling fan is equipped for heat dissipation and improved reliability, supporting 24/7 operation
- Supports 8 Lane V-BY-ONE with output resolution of 3840 × 2160 @60Hz
- Using the latest V-BY-ONE driver chip, the peripheral circuit is simpler and the power consumption is lower
- USB firmware upgrade function for easy maintenance and assembly
- Full hardware architecture: no CPU and operating system
- Powerful processing
- Quick start: Less than 8 seconds
- Automatic computer-driven temperature control system with the following settings: on/off/auto/user
- Supports Full HD resolution @ 1920 x 1080
- User-friendly operation.
- Control from external source available via protocol communication (RS-232)

Description

- Before operating the video wall monitor, please make sure you fully understand relevant prerequisites such as the specification or limitation of H/W and S/W. ViewZ shall not be responsible for loss, damage or injury caused by improper use of products.
- You are not allowed to copy, use, alter or disseminate this manual in whole or in part without prior written consent.
- Any and all product names, model names, labels, or company names used in this manual are the trademarks and registered trademarks of ViewZ.
- If you have any advice or question related to this manual, please contact our dealer, re-seller or our customer service representatives.

CONNECT EXTERNAL EQUIPMENTS

Interface Ports

The following image is the description of interface input ports

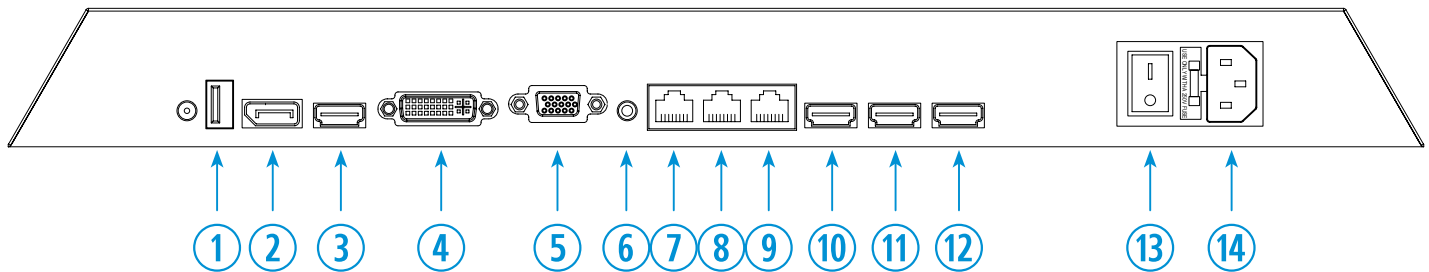

1. **USB** - For upgrading SW
2. **DP IN**
3. **HDMI1 IN**
4. **DVI-D IN**
5. **VGA IN**
6. **AUDIO OUT**
7. **RS232 (RJ-45) IN** - Serial Control / IR Receiver
8. **RS232 (RJ-45) OUT - A** - Serial Control / IR Receiver
9. **RS232 (RJ-45) OUT - B** - Serial Control / IR Receiver
10. **HDMI2 IN (Daisy Chain)**
11. **HDMI2 OUT - A (Daisy Chain)**
12. **HDMI2 OUT - B (Daisy Chain)**
13. **POWER ON / OFF Switch**
14. **AC 100-240V IN**

Interface Resolution & Refresh Rate

Interface Input Source	Max Resolution	Refresh Rate
Display Port	3840 x 2160	30Hz
HDMI1 (2.0) In	3840 x 2160	60Hz
HDMI2 (2.0) In / Out	3840 x 2160	60Hz
DVI-D In	3840 x 2160	30Hz
VGA	1920 x 1080	60Hz

REMOTE FUNCTION

IR Remote Controller

1. **POWER ON**
2. **Number Key**- For entering ID #s
3. **ID(0)** - To setup the ID
4. **ARROW** - OSD Control
5. **ENTER** - To confirm current OSD value
6. **VGA** - To select the VGA input source
7. **DVI** - To select the DVI input source
8. **HDMI** - To select the HDMI1 input source
9. **No Function** - VIDEO/PLAY/PAUSE/STOP/REV./FWD/
PREV./NEXT.
10. **MUTE** - Turn Off the Sound (Audio Out)
11. **POWER OFF**
12. **AUTO** - Automatic position adjustment
13. **SOURCE** - Change the input source
14. **MENU** - Enter the OSD
15. **EXIT** - Exit the OSD

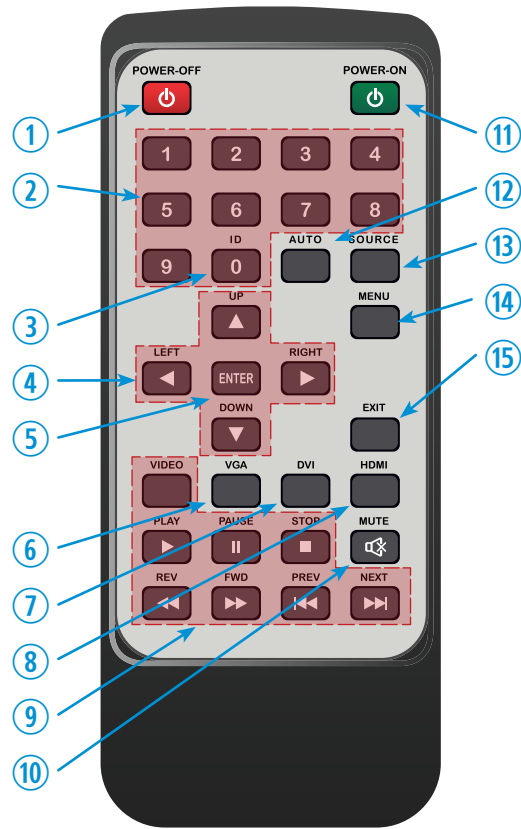

Display image, sound and custom settings can be adjusted in OSD (On Screen Display) menu by remote controller. To adjust monitor setting value:

1. Press the '**MENU**' button to enter the OSD menu.
2. Press the '**SOURCE**' button, then press the ▲ / ▼ buttons to select input source.
Press the '**ENTER**' button to select a desired input source.
3. Press the ▲ / ▼ buttons to select the desired sub-menu. The selected sub-menu will be highlighted.
4. Press the ◀ / ▶ buttons to change the value you wish to adjust.
5. Press the '**ENTER**' button to confirm / the '**MENU/EXIT**' button to exit for saving adjustment value on sub-menu.
6. Press the '**MUTE**' button to on / off audio-out of monitor.

CONTROL AND FUNCTION

Select Input Source

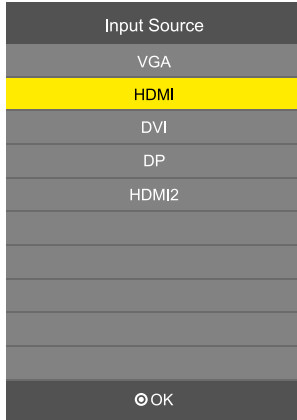

Press 'SOURCE' button on monitor or on remote controller.

Press ▲ / ▼ button to change input source and then press **ENTER** button to select input source on remote controller.

If you connect any input source, monitor will display current input source resolution and frequency.

CONTROL AND FUNCTION

Picture

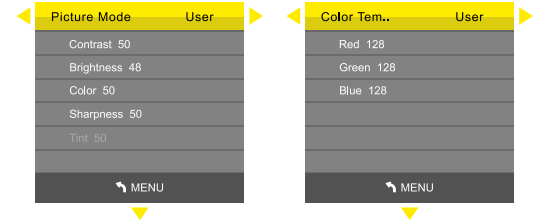
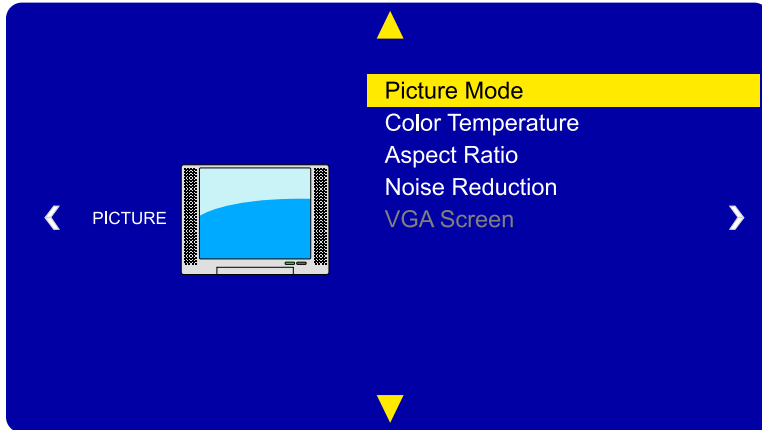

▲/▼ MOVE ◀/▶ ADJUST
 ENTER SELECT MENU RETURN

PICTURE MODE		VALUE
VIVID	Reduce contrast and sharpness	
USER	Applies user selected values - brightness, contrast, sharpness, tint and color	
CONTRAST	Adjusts the difference between the lightest and darkest parts of the image	0 ~ 100 (default: 50)
BRIGHTNESS	Adjust the brightness	0 ~ 100 (default: 50)
COLOR	Adjust the color value	0 ~ 100 (default: 50)
SHARPNESS	Adjusts projected image sharpness	0 ~ 100 (default: 50)
TINT	Adjusts the image color balance of red and green	0 ~ 100 (default: 50)
SOFT	Provide enhanced contrast and sharpness	
STANDARD	Provide standard contrast and sharpness	

COLOR TEMPERATURE		VALUE
WARM	Give the white color a reddish tint	
NORMAL	Give the white color a neutral tint	
COOL	Give the white color a blue-ish tint	
USER	Apply user selected values - Red, Green & Blue	0 ~ 255

(default: R128, G128, B128)

CONTROL AND FUNCTION

Picture

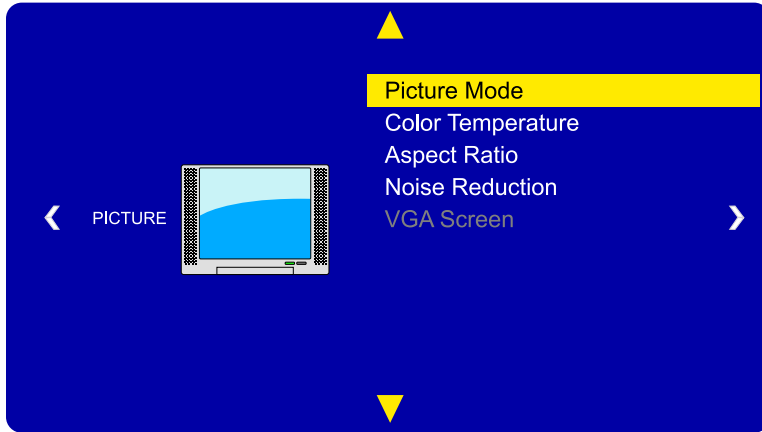

▲/▼ MOVE ◀/▶ ADJUST
 ENTER SELECT MENU RETURN



FUNCTION		VALUE
ASPECT RATIO	Adjust the video format	AUTO / 4:3 / 16:9 / ZOOM1 / ZOOM2 / JUST SCAN PANORMA / POINT TO POINT (default: AUTO)
NOISE REDUCTION	Estimates the amount of noise automatically and applies suitable noise reduction processing	OFF / LOW / MIDDLE / HIGH / DEFAULT (default: OFF)

CONTROL AND FUNCTION

Time

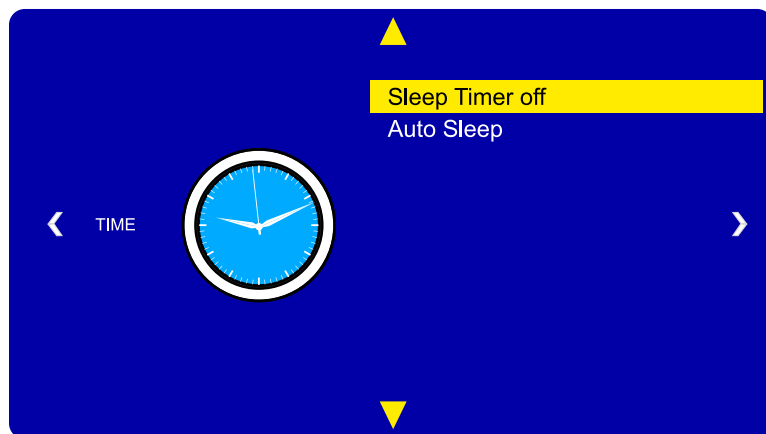

▲/▼ MOVE ◀/▶ ADJUST
 ENTER SELECT MENU RETURN

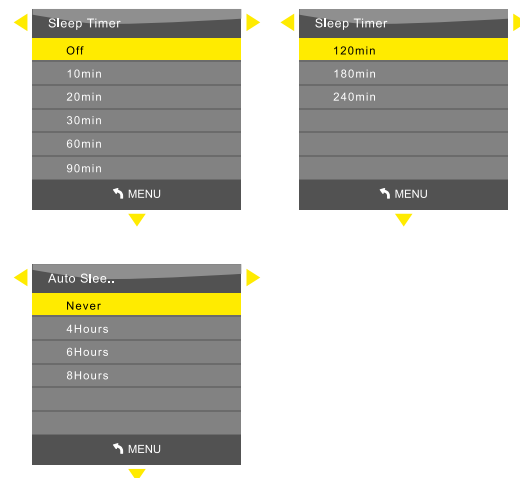

FUNCTION		VALUE
SLEEP TIMER	Setup the time of sleeping mode	OFF / 10 / 20 / 30 MIN 60 / 90 / 120 / 180 / 240 MIN (default: OFF)
AUTO SLEEP	Setup the time of automatic sleeping mode	NEVER / 4 / 6 / 8 HOURS (default: NEVER)

CONTROL AND FUNCTION

Option

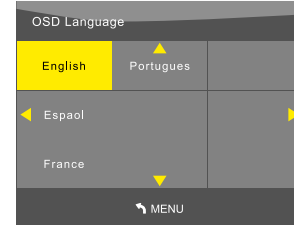
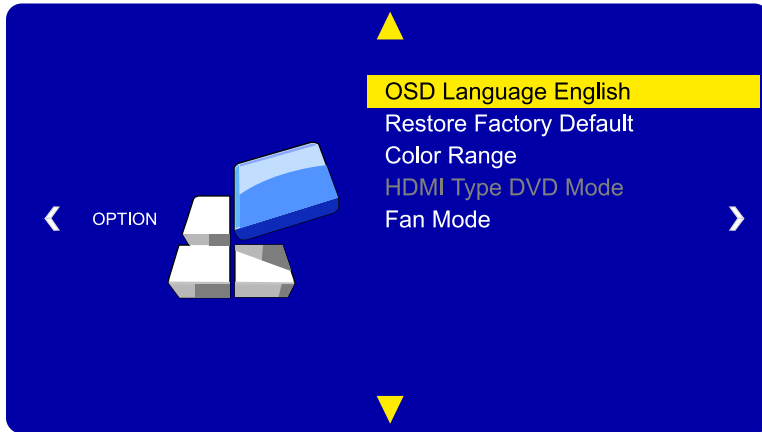

▲/▼ MOVE ◀/▶ ADJUST
 ENTER SELECT MENU RETURN

FUNCTION		VALUE
OSD LANGUAGE	Set the language of the OSD menu	English / Spanish / French / Portuguese (default: English)
RESTORE FACTORY DEFAULT	Reset the monitor settings to the factory default	YES / NO
COLOR RANGE	Set the color range	0 ~ 255 / 16 ~ 235 / AUTO (default: AUTO)
HDMI TYPE DVD MODE	Switch between DVD and PC display mode	
FAN MODE	Set the fan mode	ON / OFF / AUTO (default: OFF)

CONTROL AND FUNCTION

App



▲/▼ MOVE ◀/▶ ADJUST
 ENTER SELECT MENU RETURN

FUNCTION		VALUE
SPLICE WALL SET ¹⁾	Setup the video wall monitors	
ROW NUMBER	Select the total horizontal monitor number	1 ~ 15 (default: 1)
COLUMN NUMBER	Select the total vertical monitor number	1 ~ 15 (default: 1)
SPLICE WALL ADJUST	Switch selected/entire monitors as one of video wall system	
SINGLE DISPLAY	Switch selected/entire monitors as only one display monitor	
PLAN SETUP	User can save/delete/restor the display matrix at the monitor. User can use the plan made at the control program (Mix Control)	
PLAN SELECT	Switch plan which is saved in board	Plan 1 ~ 4 (default: PLAN 1)
PLAN LOOK	Display the plan of selected monitor	
PLAN EXECUTE	Change the plan of selected monitor	
PLAN SAVE	Save the current splicing status	

1) This mode should process when all RS232 is connected based on daisy chain setup.

1) After setup of ID setting on each monitor, user should setup this for video wall monitor matrix.

CONTROL AND FUNCTION

App

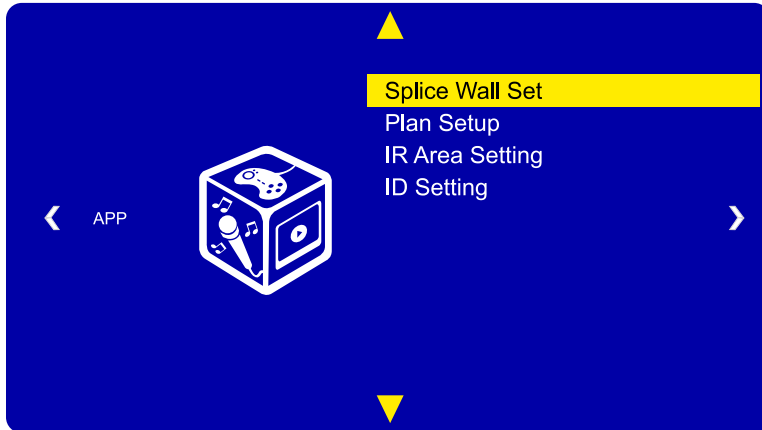

▲/▼ MOVE ◀/▶ ADJUST
ENTER SELECT MENU RETURN

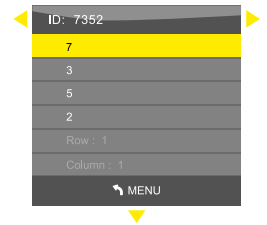
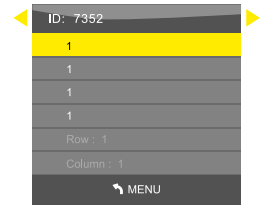
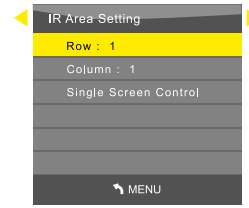

FUNCTION		VALUE
IR AREA SETTING	Control a monitor based on row and column position	
ROW	Set the row position of screen	1 ~ 15 (default: 1)
COLUMN	Set the column position of screen	1 ~ 15 (default: 1)
SINGLE SCREEN CONTROL ¹⁾	Control a monitor	
ID SETTING	Display ID and setup the physical location of monitors	
ID	4 digits logical identification code of selected monitor This ID will be changed at every time.	XXXX
NUMBER ²⁾	Change the 1 st number of identification code	0 ~ 9 (default: 1)
NUMBER ²⁾	Change the 2 nd number of identification code	0 ~ 9 (default: 1)
NUMBER ²⁾	Change the 3 rd number of identification code	0 ~ 9 (default: 1)
NUMBER ²⁾	Change the 4 th number of identification code	0 ~ 9 (default: 1)
SCREEN ROW ³⁾	Change the row number of selected monitor	1 ~ 15 (default: 1)
SCREEN COLUMN ³⁾	Change the column number of selected monitor	1 ~ 15 (default: 1)

1) To control a monitor, need to apply this. After activating this, the selected monitor will only show **OSD**.

To return or see all OSD on monitor, push '**POWER ON**' button.

2) Change the number according the ID to unlock **ID SETTING**

3) Change the screen row & column number when **NUMBER ('3')** is matching with **ID** number

DAISY CHAIN CONNECTION

How to make the HDMI daisy-chain setting

- There are two ways to set up the daisy-chained video wall.
1. Use the IR remote controller
 2. Use the Serial Control Program (M-MixControl)

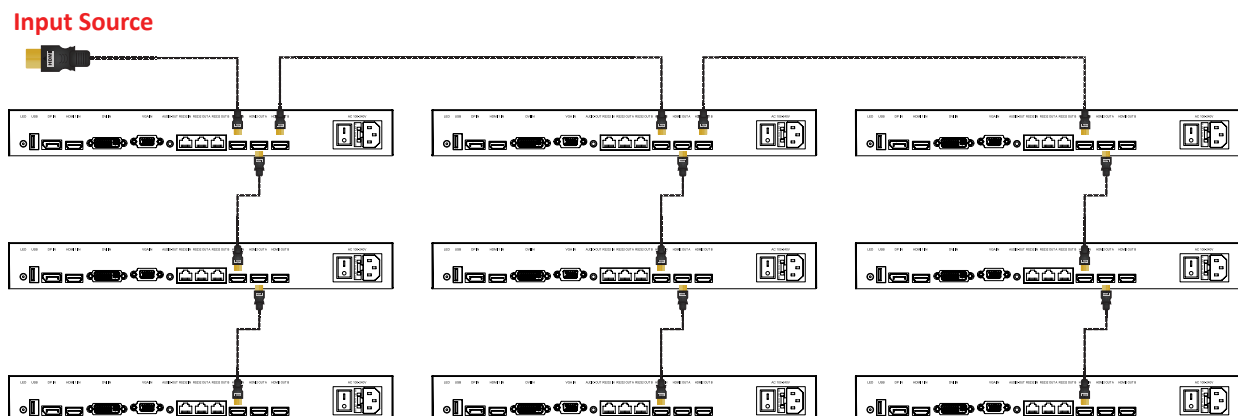
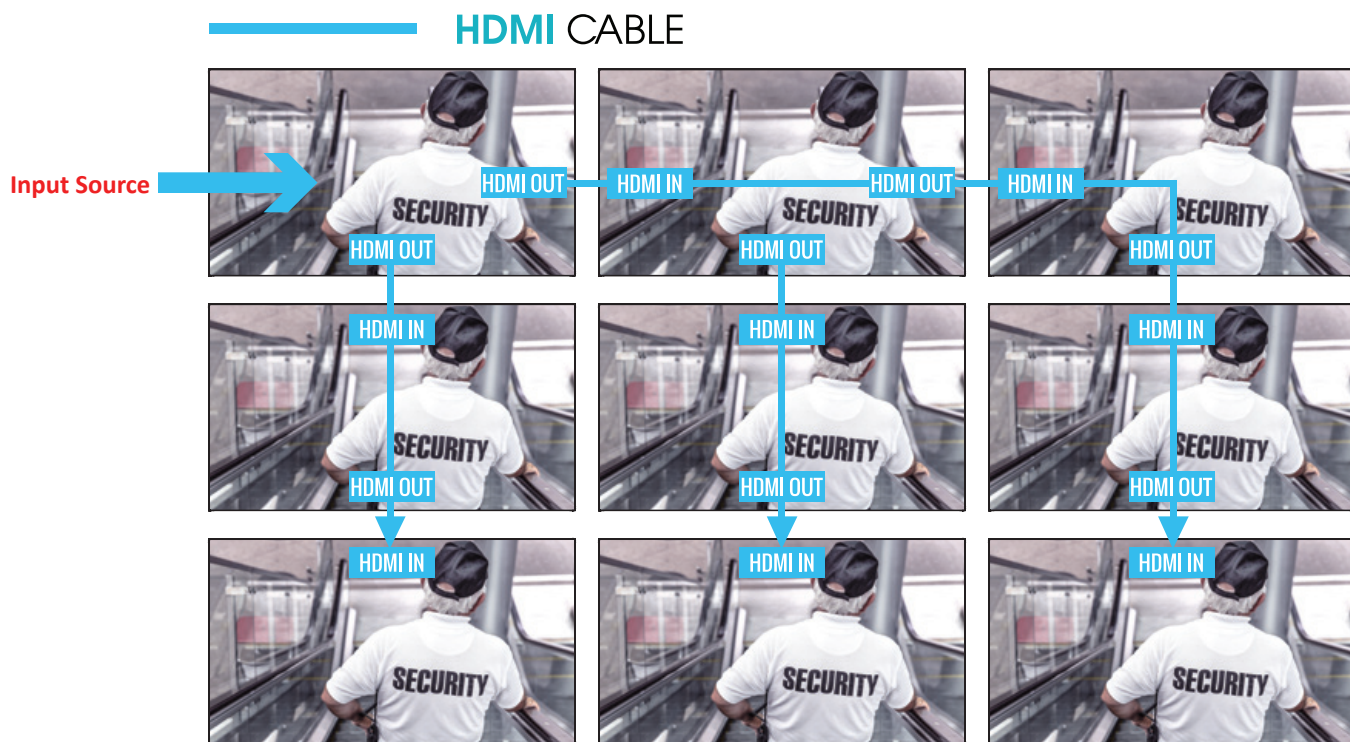

SETUP DAISY CHAIN

Using IR Remote Controller

Physical Connections

Special note: Use the short **HDMI cables** (less than 6feet) for the daisy-chain connection.
In accordance with the following figure, please connect the cables.

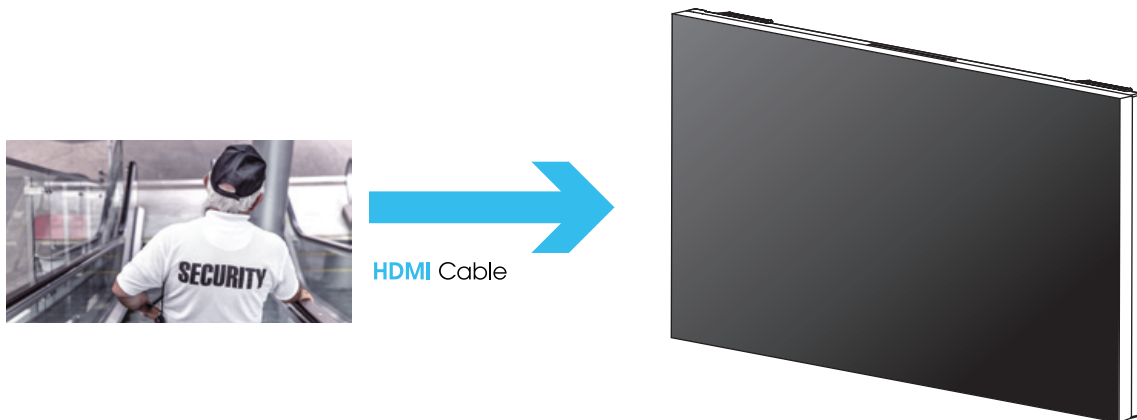

- ① Connect the Video source at the **HDMI2 IN** of 1st monitor.
- ② Connect the **HDMI cable** at **HDMI2 OUT A** of 1st monitor and **HDMI2 IN** of 2nd monitor. And connect 2nd and 3rd monitors repeatedly until the last of monitor.
- ③ Connect an IR sensor at RS232 (RJ45)-IN at 1st monitor.

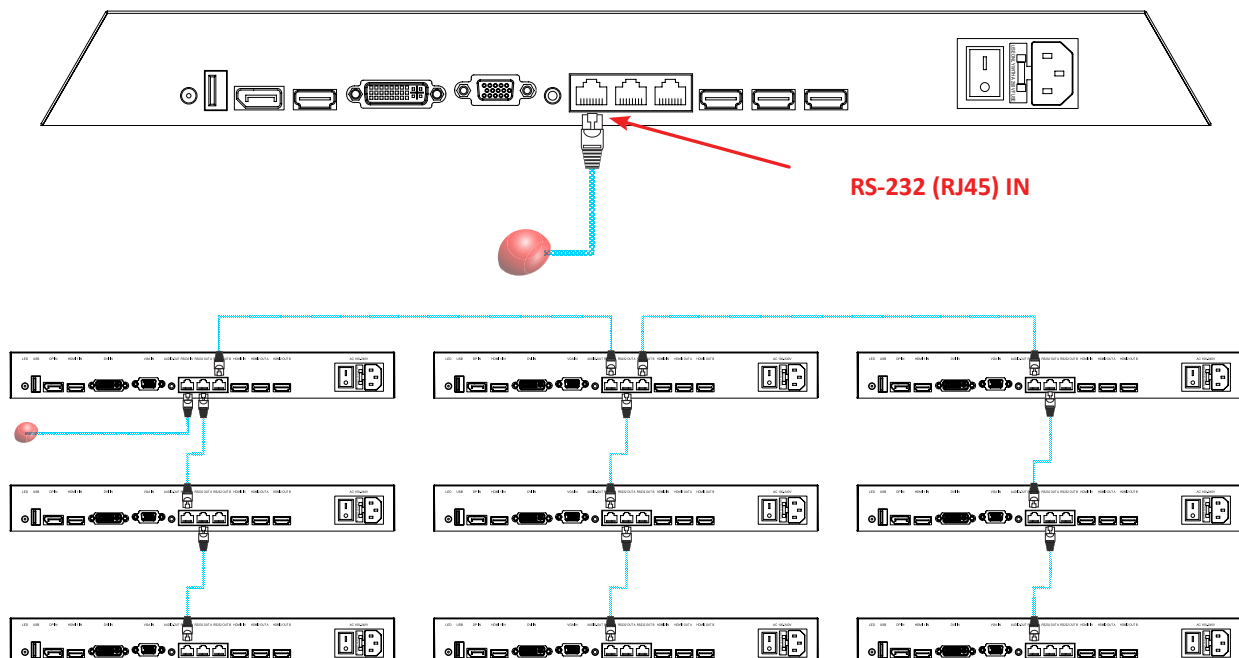

SETUP DAISY CHAIN

Setup 2x2 Videowall with Daisy-Chained

Power ON and ID Setting

- ① Power on the video source and the video wall monitors.
- ② Press **SOURCE** on the IR Remote Controller (be sure to display input source on all of monitors) & select **HDMI2**.
- ③ Press **MENU** and move to **APP** to select **IR AREA SETTING**.

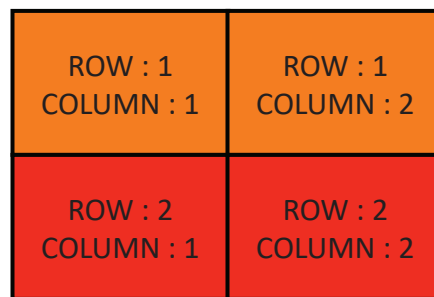

- ④ First, be sure all of 4 monitors show at **ROW-1, COLUMN-1** to start **ID SETTING** at left-top monitor and select single screen control.
- ⑤ Press **MENU** to select **ID SETTING**.

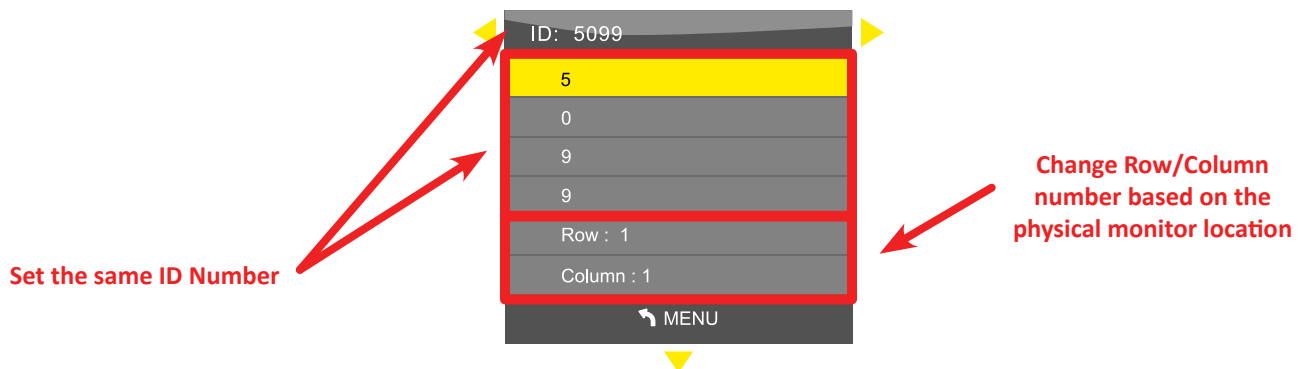

- ⑥ Set **ID number** as shown above picture. Press **MENU** and exit.
- ⑦ Press **POWER ON** button to unlock single screen control.
- ⑧ Repeat ④ to ⑦ to set up **ID SETTING** at right-top monitor (**ROW-1, COLUMN-2**).
Finish to setup **ID SETTING** until the last of monitor.

SETUP DAISY CHAIN

Setup 2x2 Videowall with Daisy-Chained

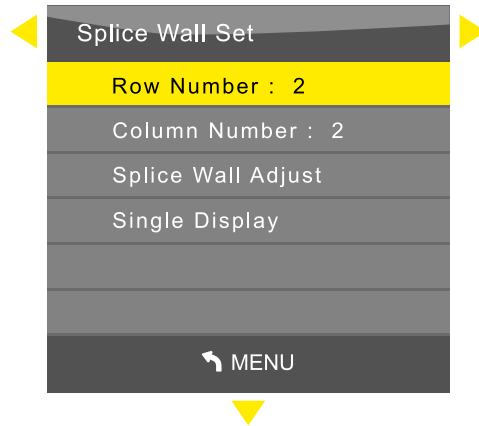

- ⑨ Press **POWER ON** button then press **MENU** and move to **APP** to select **SPLICE WALL SET**. Set **ROW** number 2 and **COLUMN** number 2.
- ⑩ Select **SPLICE WALL** adjust.



In case of 3x3 video wall **ROW** and **COLUMN** should refer to the following numbers

ROW : 1 COLUMN : 1	ROW : 1 COLUMN : 2	ROW : 1 COLUMN : 3
ROW : 2 COLUMN : 1	ROW : 2 COLUMN : 2	ROW : 2 COLUMN : 3
ROW : 3 COLUMN : 1	ROW : 3 COLUMN : 2	ROW : 3 COLUMN : 3

SETUP DAISY CHAIN

Using Serial Control Program - M-Mix Software

Power and ID Setting

- ① Power on the video source and the video wall monitors.
- ② Press **SOURCE** on the IR Remote Controller (be sure to display input source on all of monitors) and select **HDMI2** input source.
- ③ Disconnect the IR Receiver and connect the Serial Control Cable at the **RS232 (RJ45)** IN of 1st monitor
- ④ Use the remote control program (MixControl) via a computer.

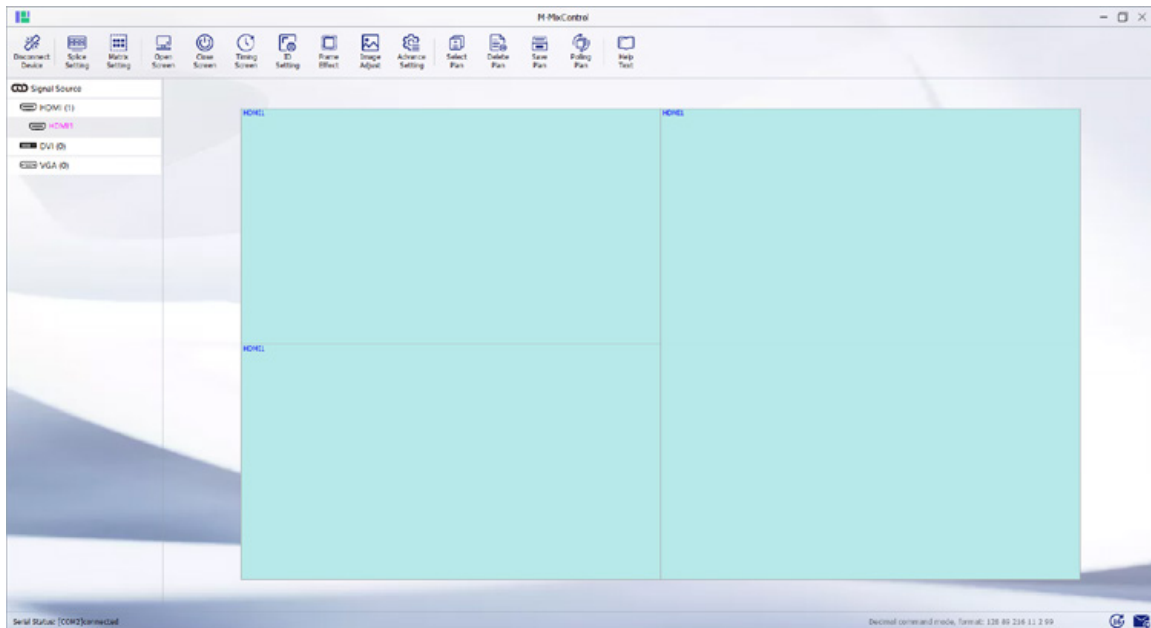

Please refer " VZ-UNBS-VideoWall-SW-Manual-M-Mix"

SETUP DAISY CHAIN

Using Serial Control Program - M-Mix Software

- If your setup is successfully done, you will see the image like below picture.

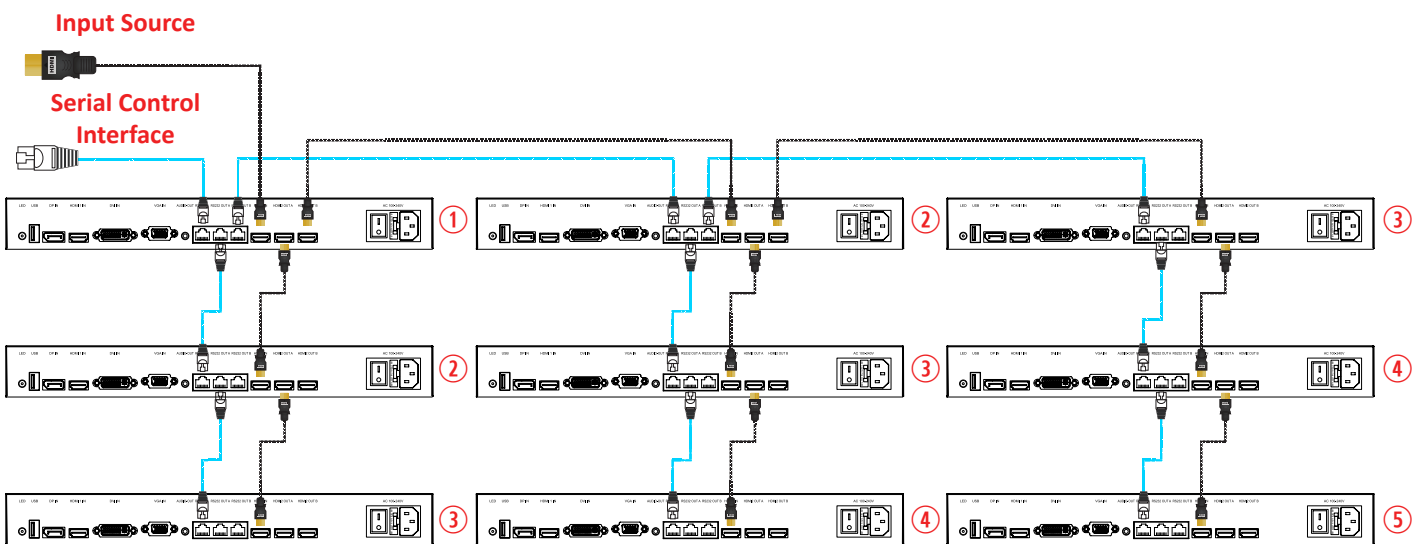
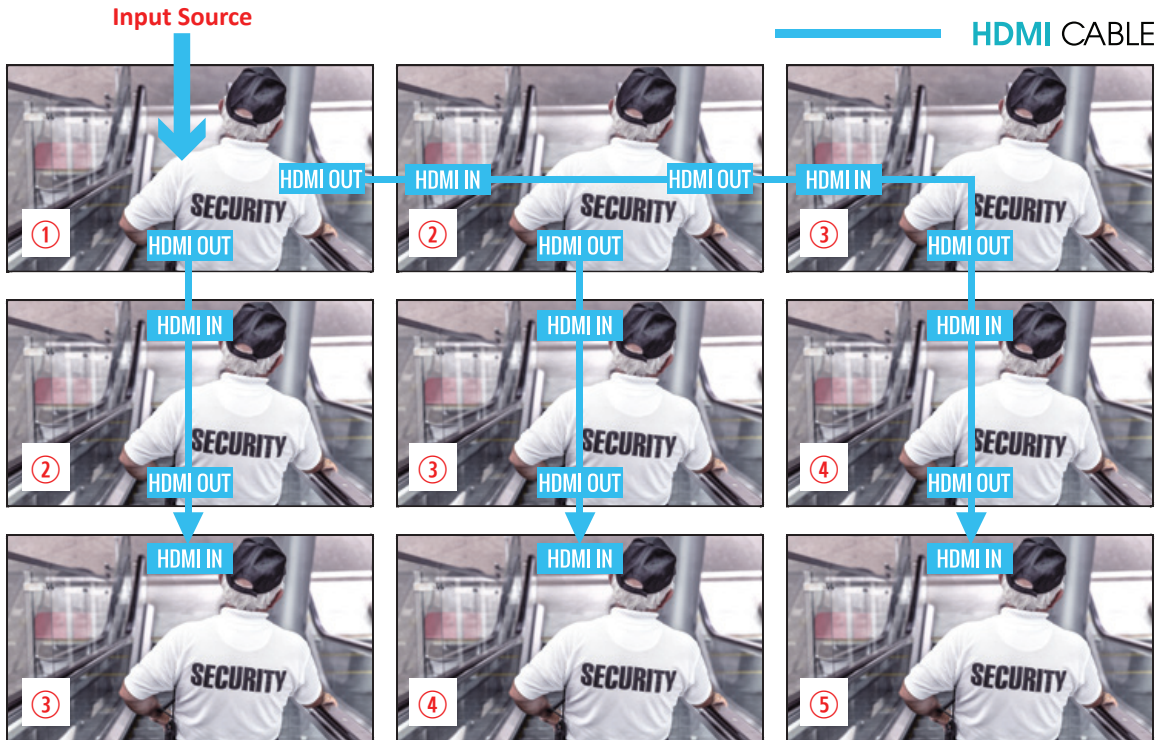

①-⑤ Connection order of monitors

Cable Type

- Cat 5 Cable
- HDMI Cable

RS232 (RJ-45) PIN ASSIGNMENT

PIN MAP

The following image is the description of RJ-45 PIN MAP

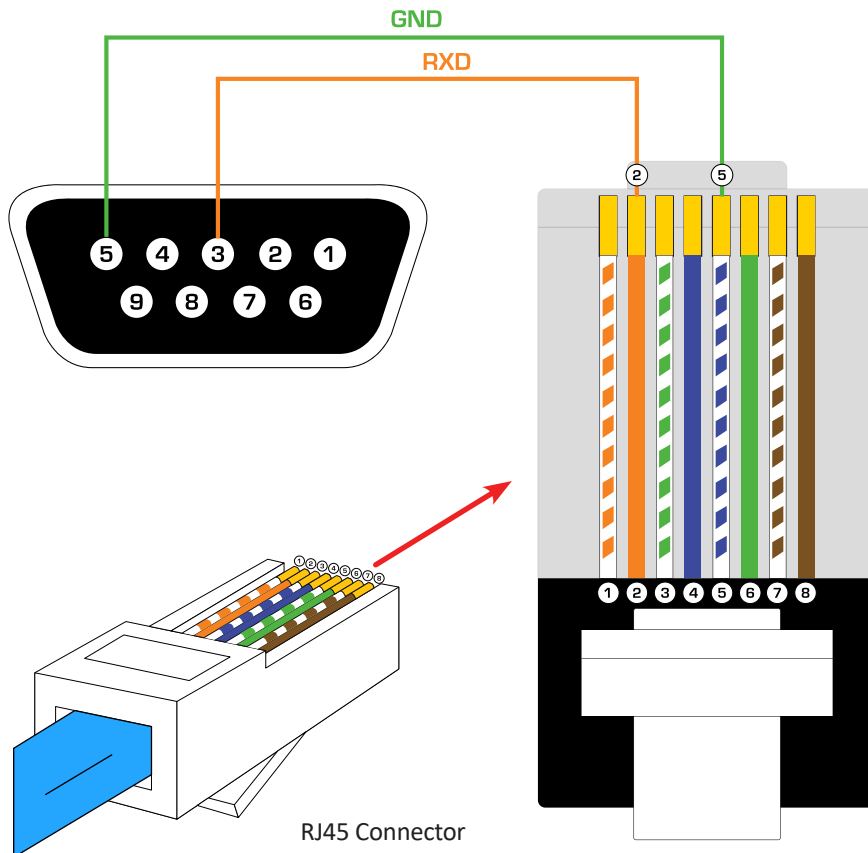

	RS232 (DP9)	RJ45
RXD (Received Data)	3	2
GND (Groud)	5	5

If your video wall system requires an unified control by the central control (do not use provided video wall screen control software), please use the provided RJ-45(RS-232) cables to configure the sytem. If necessary, you can make your own RJ-45(RS-232) cables based on the above pin map. If you have further questions, please contact ViewZ.

Firmware Upgrade/Update Process

1. Download or copy Firmware file from ViewZ.
2. Copy the file to the empty USB
***Caution - This file should be placed in the root folder of USB.**
3. The software name is fixed as FLW_V56, BIN file type.
 Please note that the firmware file name should not be modified, otherwise the board cannot identify the firmware file.
4. Turn off the monitor and insert the USB drive to the USB interface of monitor.
5. Turn the power back on, then the monitor will be automatically upgraded/updated.
 During the upgrade/update process, the power indicator will be flashing.
 When the upgrade/update is completedm the power indicator will stop flashing.
6. After the upgrade/update process, the monitor will relaunch, indicating the update/upgrade has been completed.
***Caution - Do not turn off the power or remove the USB during upgrade/update process as the monitor board can be damaged in doing so.**

RS232 COMMAND

RS 232 Communication Command & Relevant Configurations - Set Command

In consideration of secondary development of centralized control circumstances, the function of RS232 communication command & relevant configuration setup are described as follow:

- DATA1 : Communication data header,The system is fixed as **0xD5**
- DATA2: Address, The first address identification code of the drive board (**0x11 – 0xAA**)
- DATA3: Address, The last address identification code of the drive board (**0x11 – 0xAA**)
- DATA4: Command 1
- DATA5: Command 2 - full detail as below list
- DATA6: The Data verification code (**0xAA**)

Example: For AV channel from1,1 to 3,3, splice the video wall: D5 11 33 20 00 AA

DATA 1	DATA 2	DATA 3	DATA 4	DATA 5	DATA 6
--------	--------	--------	--------	--------	--------

CLASSES	COMMAND 1 (DATA 4)		COMMAND 2 (DATA 5)	
	NUMBER	EXPLANATION	NUMBER	EXPLANATION
SWITCH CONTROL	10	POWER ON / OFF	0	POWER OFF
			1	POWER ON
CHANNEL CONTROL SPLICING	20	CHANNEL SELECTION (SPLICING)	0	AV
			1	S-VIDEO
			2	VGA
			3	DVI
			5	HDMI
			8	DP
VIDEO CONTROL	30	CONTRAST RATIO	0 / 1	DOWN / UP
	31	BRIGHTNESS	0 / 1	DOWN / UP
	32	COLOR SATURATION	0 / 1	DOWN / UP
	33	COLOR	0 / 1	DOWN / UP
	34	DEFINITION	0 / 1	DOWN / UP
	35	R GAIN	0 / 1	DOWN / UP
	36	G GAIN	0 / 1	DOWN / UP
	37	B GAIN	0 / 1	DOWN / UP
	38	HORIZONTAL POSITION	0 / 1	DOWN / UP
	39	VERTICAL POSITION	0 / 1	DOWN / UP

RS232 COMMAND

RS 232 Communication Command & Relevant Configurations - Get Command

The data format is RS232 serial port multi-machine communication format

CLASSES	COMMAND 1 (DATA 4)		COMMAND 2 (DATA 5)	
	NUMBER	EXPLANATION	NUMBER	EXPLANATION
VGA/DVI CONTROL	40	RGB CONTRAST RATIO	0 / 1	DOWN / UP
	41	RGB BRIGHTNESS	0 / 1	DOWN / UP
	42	PC COLOR TEMPERATURE	1	NORMAL TEMPERATURE
	43	PC COLOR TEMPERATURE	1	WARM TONE
	44	PC COLOR TEMPERATURE	1	COLD TONE
	45	COLOR TEMPERATURE (R)	0 / 1	DOWN / UP
	46	COLOR TEMPERATURE (G)	0 / 1	DOWN / UP
	47	COLOR TEMPERATURE (B)	0 / 1	DOWN / UP
	48	ADC R OFFESET	0 / 1	DOWN / UP
	49	ADC G OFFESET	0 / 1	DOWN / UP
	4A	ADC B OFFESET	0 / 1	DOWN / UP
	4B	ADC R GAIN	0 / 1	DOWN / UP
	4C	ADC G GAIN	0 / 1	DOWN / UP
	4D	ADC B GAIN	0 / 1	DOWN / UP
	4E	AUTO ADJUST	1	ADJUST
	4F	HORIZONTAL POSITION	0 / 1	DOWN / UP
	50	VERTICAL POSITION	0 / 1	DOWN / UP
	51	AUTOMATIC COLOR ADJUST	1	ADJUST
	52	CLOCK ADJUSTMENT	0 / 1	DOWN / UP
	53	PHASE ADJUSTMENT	0 / 1	DOWN / UP
	5a	HORIZONTAL FRAME	0 ~ 100	ADJUST
	5b	VERTICAL FRAME	0 ~ 100	ADJUST
	5c	STILL	1	CHANGE
	SYSTEM	60	USER RESET	1
70		SAVE DATA	1	SAVE THE VALUES FOR THE ABOVE ADJUSTMENT

RS232 COMMAND

RS 232 Communication Command & Relevant Configurations - Set Command

The data format is RS232 serial port multi-machine communication format

CLASSES	COMMAND 1 (DATA 4)		COMMAND 2 (DATA 5)	
	NUMBER	EXPLANATION	NUMBER	EXPLANATION
FUNCTION ADJUSTMENT	76	FAN & TEMPERATURE CONTROL	0	FAN CONTROL BY TEMP. 45°C RUN THE FAN & 35°C OFF THE FAN
			1	RUN THE FAN
			2	OFF THE FAN
	77	RUN THE FAN ON THE MAX TEMPERATURE	XX	
78	RUN THE FAN ON THE MIN TEMPERATURE	XX		
SYSTEM PARAMETER ADJUSTMENT	80	TI PARAMETER	0 / 1	ADJUST / ADJUST
	81	TI MODE	0	NORMAL MODE
			1	MEMORY MODE
			1	INVOKE
	82	SOFTWARE INFORMATION	1	INVOKE
	83	AUTOMATIC STARTUP ADJUSTMENT	0 / 1	OFF / ON
			0 / 1	BLACK / BLUE
90	BACKLIGHT BRIGHTNESS ADJUSTMENT	0 / 1	DOWN / UP	
9f	TEST SIGNAL	0 / 1	DOWN / UP	
PREPLAN MODE	A0	SAVE PREPLAN MODE	1 ~ 16	SAVE
	A1	INVOKE PREPLAN MODE	1 ~ 16	INVOKE
	A2	BACKLIGHT BRIGHTNESS	0 ~ 255	
	A3	S-SYSTEM	0	AUTO
			1	PAL
			2	NTSC
			3	SECAM

RS232 COMMAND

RS 232 Communication Command & Relevant Configurations - Set Command

The data format is RS232 serial port multi-machine communication format

CLASSES	COMMAND 1 (DATA 4)		COMMAND 2 (DATA 5)	
	NUMBER	EXPLANATION	NUMBER	EXPLANATION
GRAIN REDUCTION MODE	A4		0	CLOSE
			1	LOW
			2	MIDDLE
			3	HIGH
			4	AUTO
AB GROUP EXCHANGE	A5		0	NORMAL
			1	EXCHANGE 2 SETS OF DATA
	81	AB GROUP MODE	0	NORMAL MODE
			1	MEMORY MODE
REPRODUCIBILITY ADJUSTMENT	b8	HORIZONTAL DIRECTION	0 / 1	DECREASE / INCREASE
	b9	VERTICAL DIRECTION	0 / 1	DECREASE / INCREASE

MOUNTING GUIDE

Wall Mounting (Optional)

VZ-UNBS monitors are suitable for universal wall mount (not included).

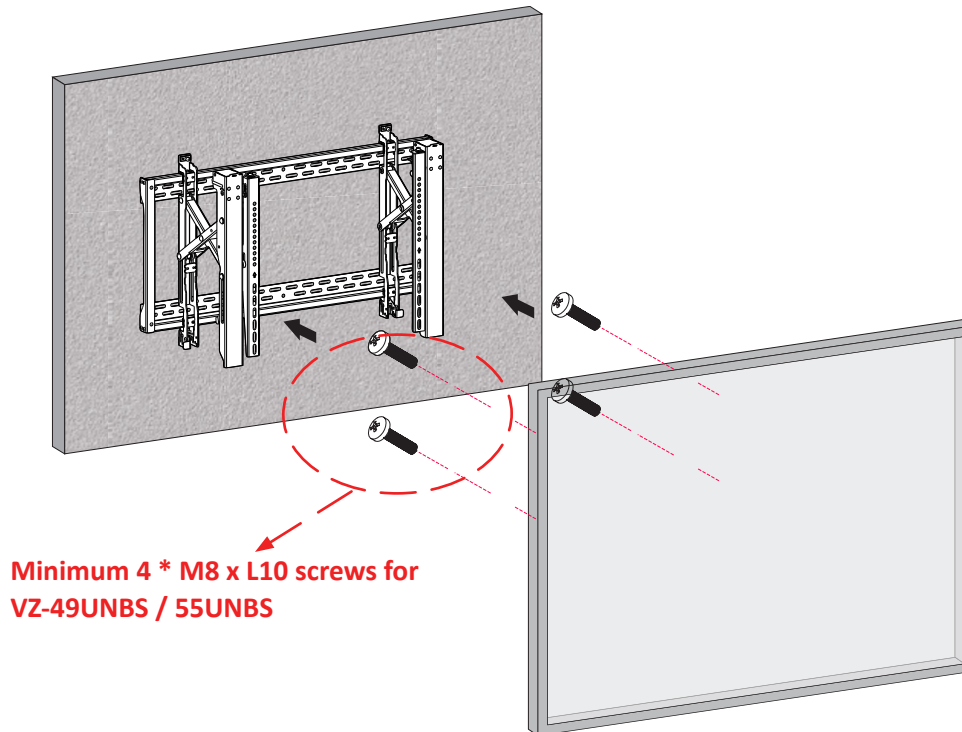

1. VZ-49UNBS & VZ-55UNBS : Universal WALL MOUNT 600 x (100 x 4) mm

! WARNING !

If user uses screws bigger and longer than M8 x L10 mm for VZ-49UNBS & VZ-55UNBS it may cause damage to the unit. Please use bolt of correct size and length as instructed.

! Mounting Safety !

At least two people are recommended to safely install the mount and monitor.

SPECIFICATION

Model No.	VZ-49UNBS	VZ-55UNBS	
Size & Type	49"	55"	
LCD	Panel Type	49" LED Backlit Monitor	55" LED Backlit Monitor
	Pixel Pitch (mm)	0.55926 (H) x 0.55926 (V) mm	0.630 (H) x 0.630 (V) mm
	Brightness	450 cd/m ²	500 cd/m ²
	Contrast Ratio	1200 : 1	1200 : 1
	Viewing Angle	178° / 178°	
	Display Color	16.7 Million Colors	
	Response Time	< 8ms (Gray to Gray)	< 8ms (Gray to Gray)
	Resolution	1920 (H) x 1080 (V)	
	Active Display Area	1074.1 (H) x 604.3 (V) mm	1209.6 (H) x 680.4 (V) mm
	Aspect Ratio	16 : 9	
Bezel width (T & B / L & R)	0.096" x 0.053" / 2.3 x 1.2 mm		
Active to Active Bezel	0.149" / 3.5 mm		
Case Type	Black Metal		
Operating Temperature	32°F ~ 122°F / 0°C ~ 50°C		
Storage Temperature	32°F ~ 140°F / 0°C - 60°C		
Operating Humidity	20 ~ 80% RH		
Weight	Net : 54.89 lb / 24.5 kg	Net : 65.91 lb / 29.9 kg	
	Gross : 74.73 lb / 33.9 kg	Gross : 88.18 lb / 40.0 kg	
INTERFACE	HDMI INPUT x 2 / OUTPUT x 2, DP INPUT x 1, DVI-D INPUT x 1, VGA (15Pin D-Sub) INPUT x 1, RS232(RJ-45) INPUT x 1, RS232(RJ-45) OUTPUT x 2, AUDIO OUPUT x 1, USB (Upgrade) x 1		
Safety & EMC Certification	FCC / RoHS		
Electrical Ratings	AC 100-240V, 50/60Hz, 2.0A		
Power Consumption	≤ 140 W (Max) / 0.5 W (Standby)	≤ 180 W (Max) / 0.5 W (Standby)	
Accessories	AC110V Power Cable x 1, HDMI Cable x 1, Manual x1, CAT5 Cable (RS232) x 1, Remote Controller x 1, IR Receiver x 1, Converter (RJ45 to RS232) x 1		

TROUBLESHOOTING GUIDE

- Check the following before calling for service.
- If the same problems continue after checking, contact the reseller you purchased the monitor from.

At start	We recommend that you test with different input sources when you have trouble with the current input source. If symptom persists, follow the instructions below. After following the instructions below, please contact us at 1-888-99-VIEWZ.
No image or Noise on the screen	<ul style="list-style-type: none"> - Make sure the cable is correctly plugged into the outlet. - Make sure the power cable is correctly plugged into the monitor. - Make sure the cable is correctly connected between monitor & source. - Make sure to use RS-232/RJ-45 cable provided with the monitor - Check the RS-232/RJ-45 cable connection & Daisy chain wiring configuration. - Check the brightness setting and see if brightness is set to 'Ø'. - Check the video source.
Incorrect display or Half display	<ul style="list-style-type: none"> - Check your video source - Reset video source : connection, cable replacement, setting & more
Flickering and shadow image	<ul style="list-style-type: none"> - Check your input source setting for resolution and phase (Hz)
The audio function is not working	<ul style="list-style-type: none"> - Check the volume and make sure MUTE is not on - Check HDMI / BNC / Audio port cable connection
LED is flickering or no image	<ul style="list-style-type: none"> - Check the interface cable connection and make sure it's plugged in correctly - Check the input source

TERMS OF WARRANTY / RMA

- The warranty period for this monitor is 3 years. The warranty will be voided for the scenarios listed below.
- You can also download the manual and information on VIEWZ web site: VIEWZUSA.COM

Cases of Non-Warranty Coverage	When power feed to the monitor exceeds capacity and causes damage.
	Accident, Abuse, Misuse, Neglect, Fire, Water/liquids, Lightning or any act of nature.
	Damaged by dropping, throwing and hitting the monitor.
	Failure caused by user's attempt to modify the product.
	Failure by limited life of parts such as LED lamps and any other consumables.
	Damaged by using third party power cable, unstable power input and electric shock.

* Above information can be changed without notification - please check our website or contact ViewZ representative for the latest RMA service policy.

* When shipping the monitor for RMA, make sure to pack safely to ensure the monitor is not damaged during shipping.

NOTE

WARRANTY

ViewZ USA LIMITED 3 YEAR WARRANTY

What and Who is Covered by this Limited Warranty and for How Long

ViewZ USA warrants this product to be free from defects in material and workmanship for 3 years to the original owner of this product. The limited warranty is valid only for the original purchaser of the product.

What ViewZ USA Will Do

At their sole discretion, ViewZ USA will repair or replace any product or product part that is defective. If ViewZ USA chooses to replace a defective product or part, a replacement product or part will be shipped to you at no charge, but you must pay any labor costs.

What is Not Covered; Limitations

ViewZ USA disclaims any liability for damage to mounts, adapters, displays, projectors, other property, or personal injury resulting, in whole or in part, from improper installation, modification, use or misuse of its products.

ViewZ USA disclaims all other warranties, express or implied, including warranties of merchantability and fitness for a particular purpose. ViewZ USA is not responsible for incidental or consequential damages, including but not limited to, inability to use its products or labor costs for removing and replacing defective products or parts. Some states do not allow the exclusion or limitation of incidental or consequential damage, so the above limitation or exclusion may not apply to you.

What Customers Must Do for Limited Warranty Service

If you discover a problem that you think may be covered by the warranty you MUST REPORT it in writing to the address below within thirty (30) days. Proof of purchase (an original sales receipt) from the original consumer purchaser must accompany all warranty claims. Warranty claims must also include a description of the problem, the purchaser's name, address, and telephone number. General inquiries can be addressed to ViewZ USA Customer Service at 1-888-998-4399. Warranty claims will not be accepted over the phone or by fax.

ViewZ USA
Attn: Warranty Claim
177 W. Orangethorpe Ave.
Placentia, CA 92870

How State Law Applies

This warranty gives you specific legal rights, and you may also have other rights which vary from state to state.

Disclaimer

ViewZ USA intends to make this manual accurate and complete. However, ViewZ USA makes no claim that the information contained herein covers all details, conditions or variations, nor does it provide for every possible contingency in connection with the installation or use of this monitor. The information contained in this document is subject to change without notice or obligation of any kind. ViewZ USA makes no representation of warranty, expressed or implied, regarding the information contained herein. ViewZ USA assumes no responsibility for accuracy, completeness or sufficiency of the information contained in this document.

Contact Us

NORTH AMERICA
177 W. Orangethorpe Ave.
Placentia, CA 92870
USA and Canada
Phone: 1-888-998-4399
Fax: 1-714-996-1138
Other Locations
Phone: (001) 888-998-4399
Fax: (001) 714-996-1138

© ViewZ USA