

VC-TR1

Auto Tracking Camera

User Manual - English

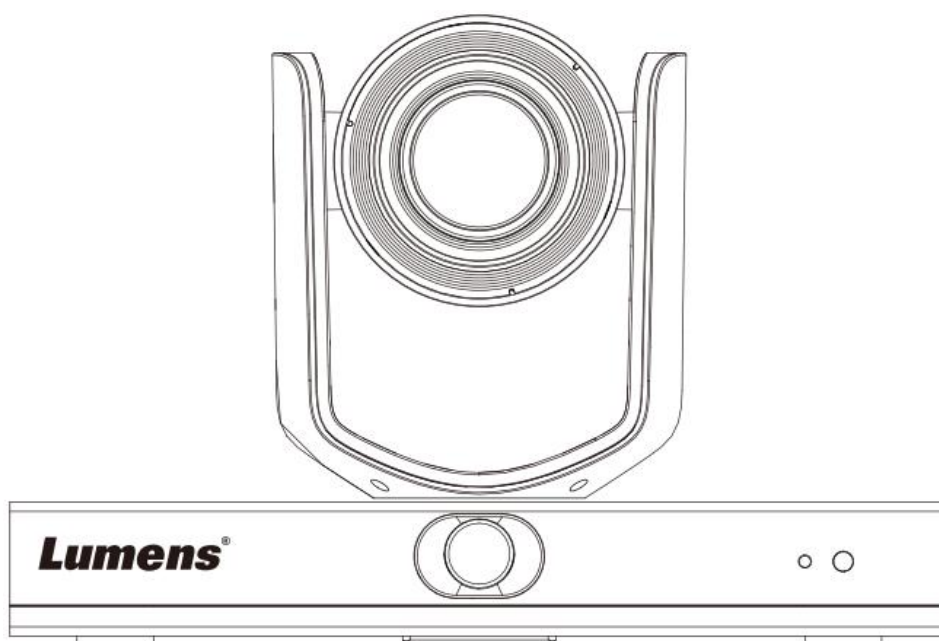

[Important]

To download the latest version of Quick Start Guide, multilingual user manual, software, or driver, etc., please visit Lumens <https://www.MyLumens.com/support>

Table of Contents

Copyright Information	2
Chapter 1 Safety Instructions	3
Chapter 2 Package Contents	4
Chapter 3 Function Introduction	5
3.1 I/O Functions Introduction	5
3.2 Description of LED indicator.....	6
Chapter 4 Instruction for installation	7
4.1 Scenario.....	7
4.2 Camera Size.....	7
4.3 Preparation before installation	8
4.4 Instruction for installation.....	8
4.5 Connecting Devices.....	9
Chapter 5 Remote Control and Setting Menu	11
5.1 Functions of remote control	11
5.2 Setting Menu	12
Chapter 6 Network Function Settings Description	14
6.1 Connecting Camera to Network.....	14
6.2 Using LumensCMS Software to View the Images	14
6.3 Using RTSP Player to View the Images.....	15
6.4 Get the VC-TR1 image by connecting the computer via USB	15
Chapter 7 DIP Switch Setting	17
7.1 OUTPUT SWITCH	17
Chapter 8 Troubleshooting.....	18
Appendix 1 	19
Supplier's Declaration of Conformity 47 CFR § 2.1077 Compliance Information	20

Copyright Information

Copyrights © Lumens Digital Optics Inc. All rights reserved.

Lumens is a trademark that is currently being registered by Lumens Digital Optics Inc.

Copying, reproducing or transmitting this file is not allowed if a license is not provided by Lumens Digital Optics Inc. unless copying this file is for the purpose of backup after purchasing this product.

In order to keep improving the product, Lumens Digital Optics Inc. hereby reserves the right to make changes to product specifications without prior notice. The information in this file is subject to change without prior notice.

To fully explain or describe how this product should be used, this manual may refer to names of other products or companies without any intention of infringement.

Disclaimer of warranties: Lumens Digital Optics Inc. is neither responsible for any possible technological, editorial errors or omissions, nor responsible for any incidental or related damages arising from providing this file, using, or operating this product.

Chapter 1 Safety Instructions

Always follow these safety instructions when setting up and using the VC-TR1 Auto Tracking Camera:

1 Operation

- 1.1 Please use the product in the recommended operating environment, away from water or source of heat
- 1.2 Do not place the product on a tilted or unstable trolley, stand or table.
- 1.3 Please clean the dust on the power plug prior to usage. Do not insert the product's power plug into a multiplug to prevent sparks or a fire.
- 1.4 Do not block the slots and openings in the case of the product. They provide ventilation and prevent the product from overheating.
- 1.5 Do not open or remove covers, otherwise it may expose you to dangerous voltages and other hazards. Refer all servicing to licensed service personnel.
- 1.6 Unplug the product from the wall outlet and refer servicing to licensed service personnel when the following situations happen:
 - If the power cords are damaged or frayed.
 - If liquid is spilled into the product or the product has been exposed to rain or water.

2 Installation

- 2.1 For security considerations, please make sure the standard hanging rack you bought is in line with UL or CE safety approbations and installed by technician personnel approved by agents.

3 Storage

- 3.1 Do not place the product where the cord can be stepped on as this may result in fraying or damage to the lead or the plug.
- 3.2 Unplug this product during thunderstorms or if it is not going to be used for an extended period.
- 3.3 Do not place this product or accessories on top of vibrating equipment or heated objects.



4 Cleaning

- 4.1 Disconnect all the cables prior to cleaning and wipe the surface with a dry cloth. Do not use alcohol or volatile solvents for cleaning.

5 Batteries (for products or accessories with batteries)

- 5.1 When replacing batteries, please only use similar or the same type of batteries.
- 5.2 When disposing of batteries or products, please adhere to the relevant instructions in your country or region for disposing of batteries or products.

■ Precautions

	This symbol indicates that this equipment may contain dangerous voltage which could cause electric shock. Do not remove the cover (or back). No user-serviceable parts inside. Refer servicing to licensed service personnel.		This symbol indicates that there are important operating and maintenance instructions in this User Manual with this unit.
---	---	--	---

■ FCC Warning

This equipment has been tested and found to comply with the limits for a Class A digital device, pursuant to part 15 of the FCC Rules. These limits are designed to provide reasonable protection against harmful interference when the equipment is operated in a commercial environment.

Notice :

The changes or modifications not expressly approved by the party responsible for compliance could void the user's authority to operate the equipment..

■ IC Warning

This digital apparatus does not exceed the Class A limits for radio noise emissions from digital apparatus as set out in the interference-causing equipment standard entitled "Digital Apparatus," ICES-003 of Industry Canada. Cet appareil numérique respecte les limites de bruits radioélectriques applicables aux appareils numériques de Classe A prescrites dans la norme sur le matériel brouilleur: "Appareils Numériques," NMB-003 édictée par l'Industrie.

■ EN55032 CE Warning

Operation of this equipment in a residential environment could cause radio interference.

Chapter 2 Package Contents

VC-TR1

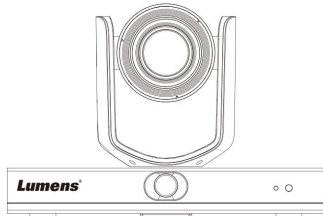

**Instruction for
installation**

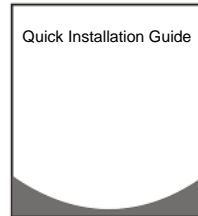

Remote Control



**USB cable
(Type A to Type A)**

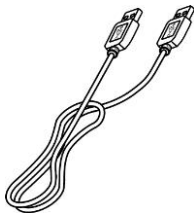

Power Cord

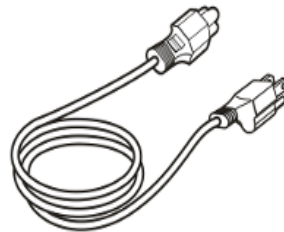

**Appearance may vary
depending on country/
region**

Power Adapter

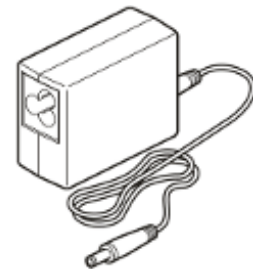

**3 PIN to 2 PIN
connector**

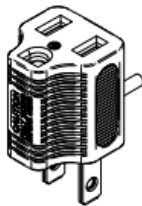

(For Japan only)

Chapter 3 Function Introduction

3.1 I/O Functions Introduction

3.1.1 Front View

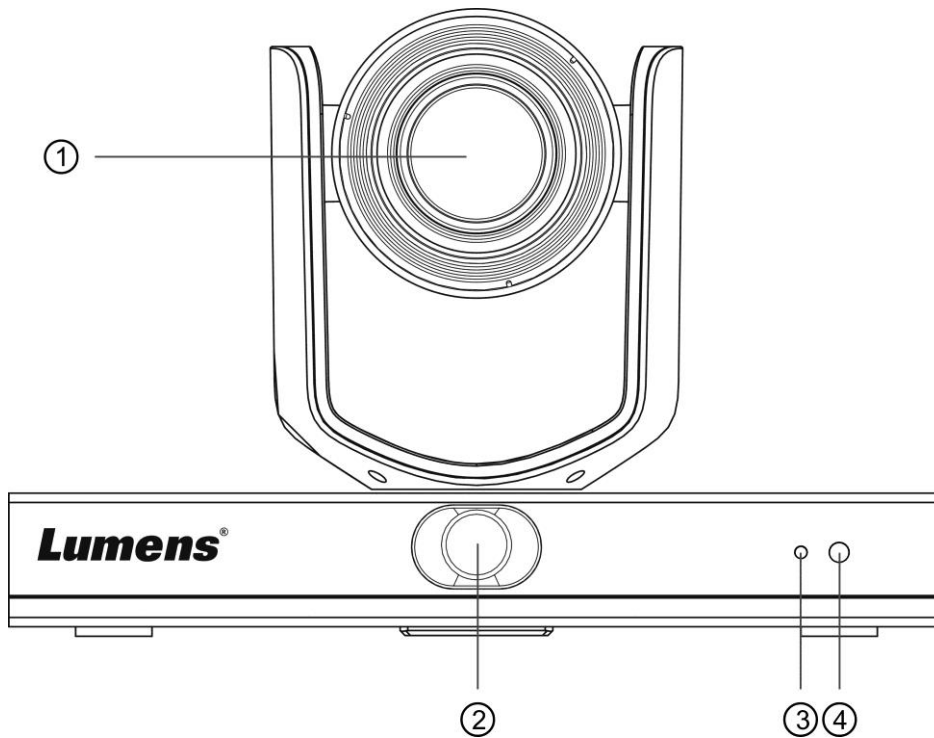

NO.	Item	Function Descriptions
1.	Camera lens	20x HD camera lens
2.	Panoramic lens	Panoramic camera lens
3.	Power indicator	Display the status of the camera, please refer to 3.2 Description of LED indicator
4.	IR receive	Support infrared remote control <Description> The recommended distance of IR remote control is within 7 meters, and the angle of remote control is $\pm 45^\circ$

3.1.2 Back View

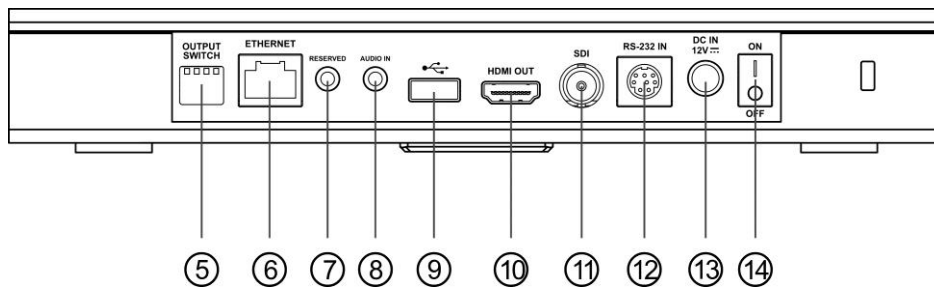

NO.	Item	Function Descriptions
5.	DIP Switch	Adjust the resolution setting, the default is MENU (based on the setting menu). The default resolution on the screen menu is 1080p60

6.	Network port	Network connecting port supports routers or hubs of PoE+ (IEEE802.3at) with power supply
7.	NA	Reserved hole
8.	Audio input	Support Line In
9.	USB 2.0 port	Can be used with conference software, and support up to 1080p30 <Description>USB and Ethernet cannot be used at the same time, and only one can be selected as an output port
10.	HDMI output	HDMI 2.0 output (Audio output not supported)
11.	SDI output	3G-SDI output (Audio output not supported)
12.	RS-232 input	RS-232 control input port
13.	Power	DC 12 V supply connecting port
14.	Power switch	On/Off the camera

3.1.3 Bottom

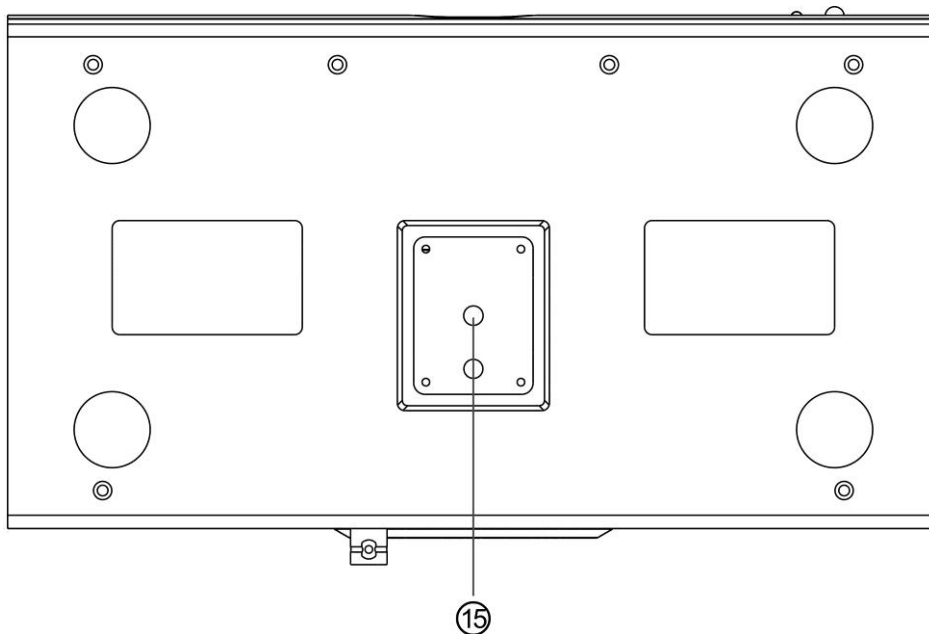

NO.	Item	Function Descriptions
15.	Tripod deck lock hole	The camera is mounted on a (specification) 1/4" - 20 UNC tripod deck

3.2 Description of LED indicator

Status	LED indicator	Note
In use	Green light	
In standby mode	Red light	The PTZ lens will face toward the bottom right
Tracking	Red light and green light flicker at the same time	The light turns from bright to dark, and from dark to bright
Stop tracking	From flickering to green light	
FW updating	Red light	After the update is complete, it will automatically reboot

Chapter 4 Instruction for installation

4.1 Scenario

- ◆ Applicable distance range of VC-TR1: 4-15 m, best tracking target distance recommended: 8 m
- ◆ Mounting height: 2 - 3 m, best height recommended: 2.4 m

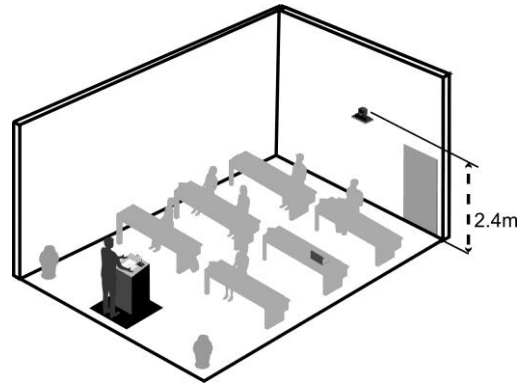
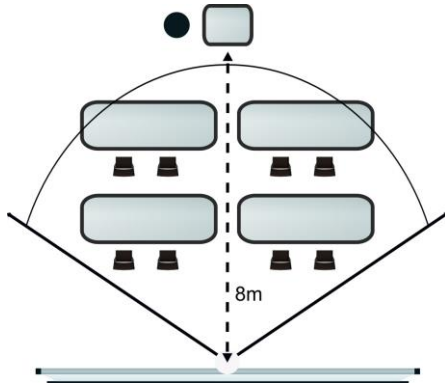

4.2 Camera Size

4.2.1 Camera Front View and Side View

Length x Width x Height: 245 x 145 x 165 mm

Weight: 1.4 Kg (without mental plates)

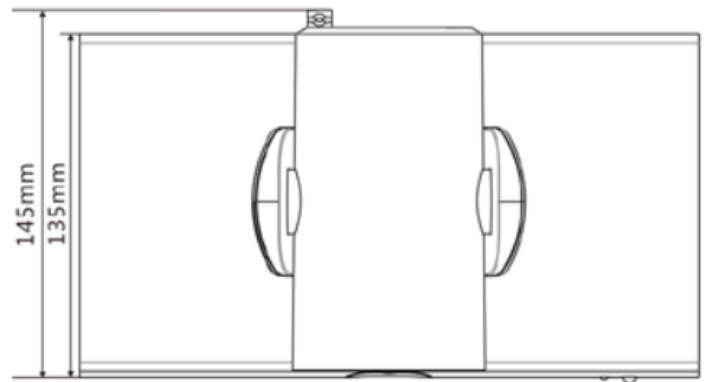
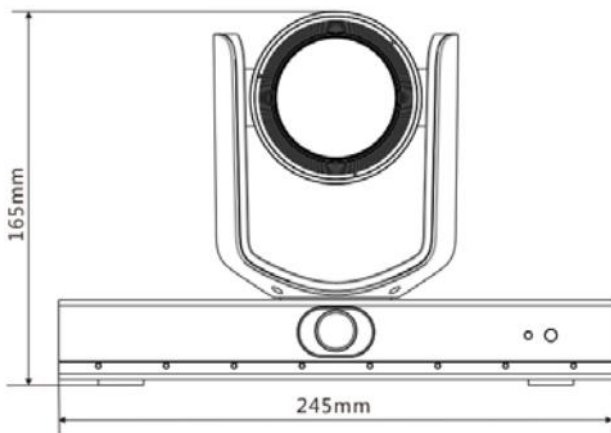

4.2.2 Bottom of Camera

The camera can be mounted on a 1/4" - 20 UNC PTZ tripod deck by using the lock holes on the bottom for the tripod

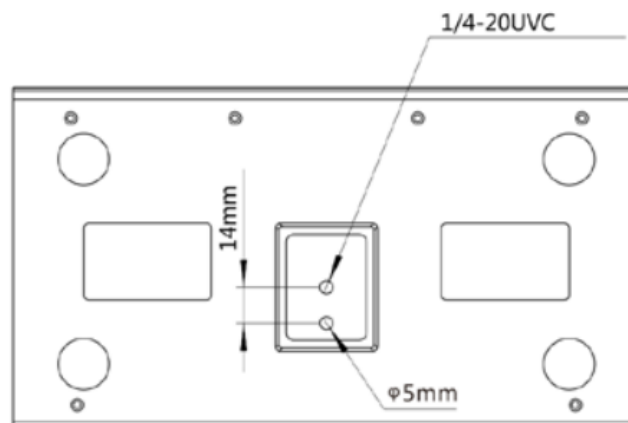

4.3 Preparation before installation

Installation and connection of HD camera requires special skills. To install by yourself, please follow necessary steps, ensure steady and tight installation of the device, and pay attention to your safety to avoid any accident.

- 4.3.1 Ensure the safety of the installation environment. Please do not install the device on unstable ceiling or in a place where the device is in danger of falling to avoid any accident.
- 4.3.2 Please check whether accessories in the box are complete or not. Please contact the supplier for any shortage, and make sure to keep the accessories in the box intact.
- 4.3.3 Please choose a proper place for installation of camera in advance. Please determine an installation place according to the following requirements
 - 4.3.3.1 Confirm the position for the object to be captured.
 - 4.3.3.2 Confirm whether the camera is set at a proper distance from other light sources.

4.4 Instruction for installation

4.4.1 Precautions for installation

- ◆ VC-TR1 does not support upside-down installation
- ◆ Do not grab the camera head by hand when handling the device
- ◆ Do not rotate the camera head by hand. Improper rotation may result in breakdown of the camera

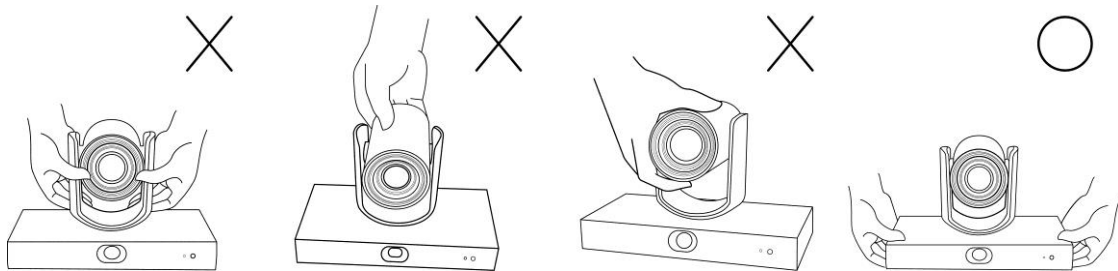

4.4.1.1 Install the camera on the desk

Please place the camera on a flat desktop to ensure the the normal vertical and horizontal operation of the machine and the good cooling of the fan at the bottom

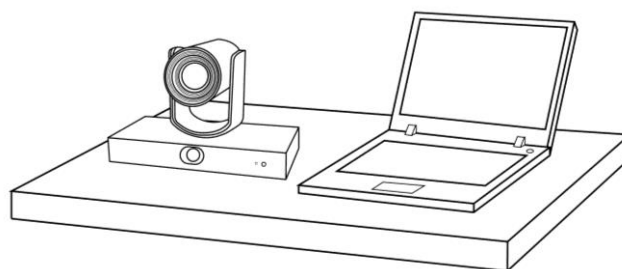

4.4.1.2 Install the camera on a tripod deck

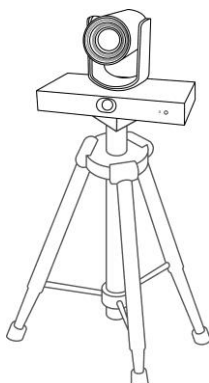

4.4.1.3 Install camera on the wall-mounted frame

When the camera is installed on the wall, it can go with Lumens VC-WM11 wall-mounted frame (optional)

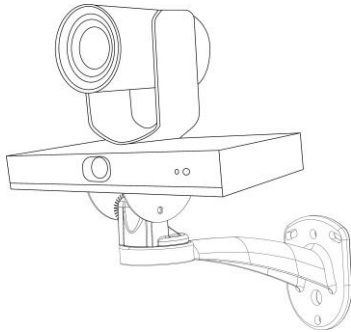

4.4.1.4 Install the camera on the ceiling bracket

To install the camera on the ceiling, the ceiling bracket can be purchased separately

4.5 Connecting Devices

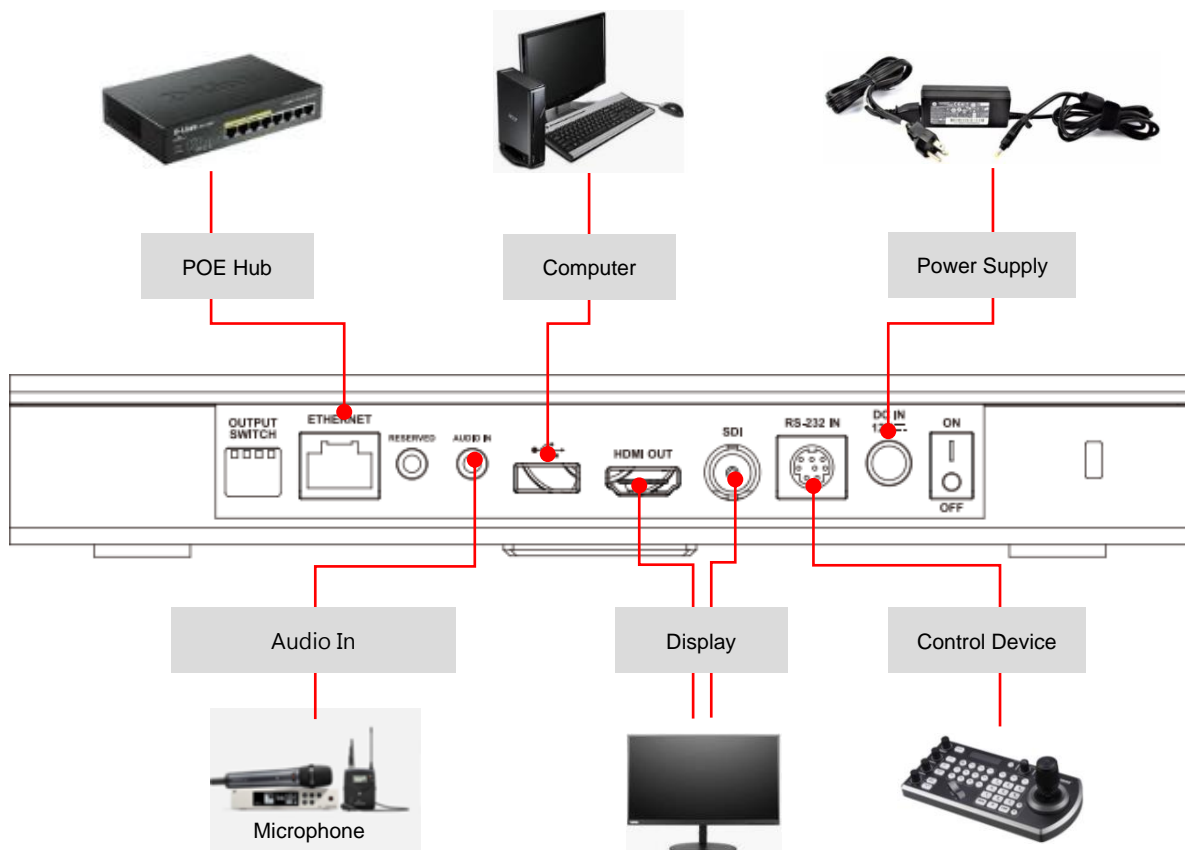

■ RS-232 pins definition instructions

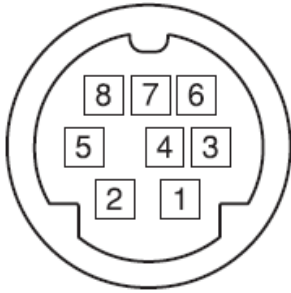

Pin NO.	Definition
1	DTR
2	DSR
3	TXD
4	GND
5	RXD
6	GND
7	IR OUT
8	N.C.

Chapter 5 Remote Control and Setting Menu

5.1 Functions of remote control



Item	Description
1	HOME button: PTZ returns to initial position
2	Buttons for selecting the camera: Only working for Camera 1 Reserved buttons for Camera 2 ~ 4, no function
3	Focus button [AUTO]: Auto focus [MANU]: Manual focus, use -close focus -long shot adjustment : One push focus, each time you press the auto focus button, it will change to manual focus mode
4	Aperture button (for manual mode) : Reset to the default value of the aperture : Increase the aperture (image becomes brighter) : Reduce the aperture (image becomes darker)
5	Menu button: Display/close OSD menu
6	Reserved button, no function
7	Number button: Used to enter numbers, such as the preset
8	Reserved button, no function
9	Power switch button: Turn on/off the camera
10	F1: start auto tracking/F2: stop auto tracking/F3: switch PTZ, panoramic screen, PIP (only applicable to HDMI/SDI output)/F4: no function
11	Reserved button, no function
12	Back light compensation button: Turn on/off back light compensation function
13	Zoom button: zoom in ; zoom out
14	Return button: Return to the upper level options of the setting menu
15	OK button: Enter the lower level options of the setting menu, confirm button
16	Direction button: Move the lens
17	Preset buttons ▲CALL: Press the number button first, then press CALL to load the location of the set ●SET: Press the number button first, then press SET to save the current location ◆CLEAR: Press the number button first, then press CLEAR to clear the location
18	Reserved button, no function

5.2 Setting Menu

<Description> Press [**Menu**] on the **remote control** to enter the setting menu; the **bold underlined** values in the following table are defaults.

1st Level	2nd Level	3rd Level	4th Level	Adjustment Values		
ANTI-FLICKER				OFF / <u>60HZ</u> / <u>50HZ</u>		
VIDEO	SHARPNESS			1~ <u>A</u> ~15		
	BRIGHTNESS			1~ <u>A</u> ~14		
	CONTRAST			1~ <u>A</u> ~14		
	GAMMA MODE			<u>0</u> ~4		
	2DNR LEVEL (2D noise reduction)			OFF, 1~ <u>A</u> ~7		
	3DNR LEVEL (3D noise reduction)			OFF, 1~ <u>A</u> ~7		
	WIDE DYNAMIC			<u>OFF</u> , 1~5		
EXPOSURE	MODE	FULL AUTO	EXP-COMP (Exposure compensation)	-7~ <u>A</u> ~7		
			BLC (Backlight compensation)	ON / <u>OFF</u>		
		MANUAL	GAIN (Gain value)	<u>0</u> ~30		
			SPEED	<u>1/60(1/50)</u> ~1/10000		
			IRIS	CLOSE, F14~ <u>F1.6</u>		
		SHUTTER PRI	SPEED	<u>1/60(1/50)</u> ~1/10000		
		IRIS PRI	IRIS	CLOSE, F14~ <u>F1.6</u>		
		BRIGHT PRI	BRIGHT (Brightness)	1~ <u>A</u> ~7		
		COLOR (color setting)	WB MODE (White balance)	AUTO	R.GAIN/ G.GAIN/ B.GAIN	-7~ <u>A</u> ~7
					SATURATION/HUE	1~ <u>A</u> ~14
ATW (Auto white balance)	R.GAIN/ G.GAIN/ B.GAIN			-7~ <u>A</u> ~7		
	SATURATION/HUE			1~ <u>A</u> ~14		
ONE PUSH	ONE PUSH TRIGGER PRESS OK			NA		

1st Level	2nd Level	3rd Level	4th Level	Adjustment Values
			SATURATION/HUE	1~ <u>A</u> ~14
		INDOOR	SATURATION/HUE	1~ <u>A</u> ~14
		OUTDOOR	SATURATION/HUE	1~ <u>A</u> ~14
		MANUAL	R.GAIN/ B.GAIN	0~ <u>A</u> ~128
			SATURATION/HUE	1~ <u>A</u> ~14
		SODIUM LAMP	SATURATION/HUE	1~ <u>A</u> ~14
		FLUO LAMP	SATURATION/HUE	1~ <u>A</u> ~14
		COLOR TEMP	CCTLEVEL	2500K~ <u>A</u> ~7500K
			SATURATION/HUE	1~ <u>A</u> ~14
PAN TILT ZOOM	PAN/TILT SPEED			1~ <u>A</u> ~8
	RATIO SPEED			ON / OFF
SYSTEM	ETHERNET	IP ASSIGNMENT		<u>DHCP</u> / STATIC IP
		IP/ MASK/ GATEWAY/ MAC		Ethernet information of the camera
	ADDRESS			<u>1</u> ~6
	PROTOCOL			<u>VISAC</u>
	BAUD RATE			<u>9600</u>
	VIDEO FORMAT (Output Format)			<u>1080P 60</u> / 50 / 30/ 25 720P 60 / 50
	LANGUAGE			<u>ENGLISH</u>
STATUS				Display the current setting status
RESTORE DEFAULT				CONFIRM / CANCEL

Chapter 6 Network Function Settings Description

6.1 Connecting Camera to Network

Two common connection methods are shown below

1. Connecting via switch or router

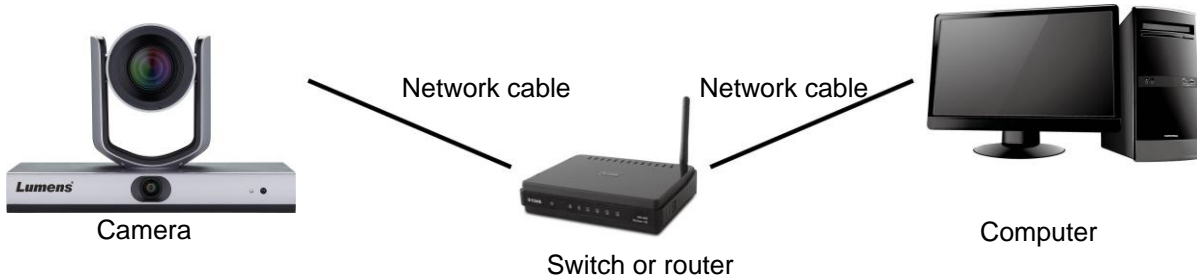

2. To connect directly through network cable, the IP address of the computer should be changed so that it is on the same network segment as the camera

E.g.: The factory-preset default IP address of VC-TR1 is 192.168.100.100. The computer IP address must be set with the same network segment, such as 192.168.100.101, so that the computer can be connected correctly with the camera

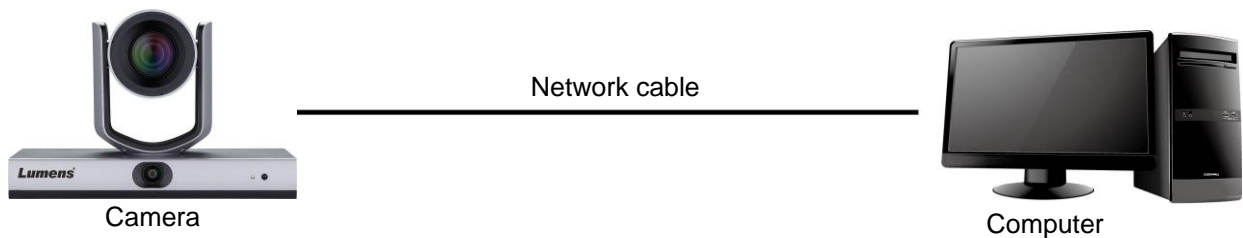

- Change network settings

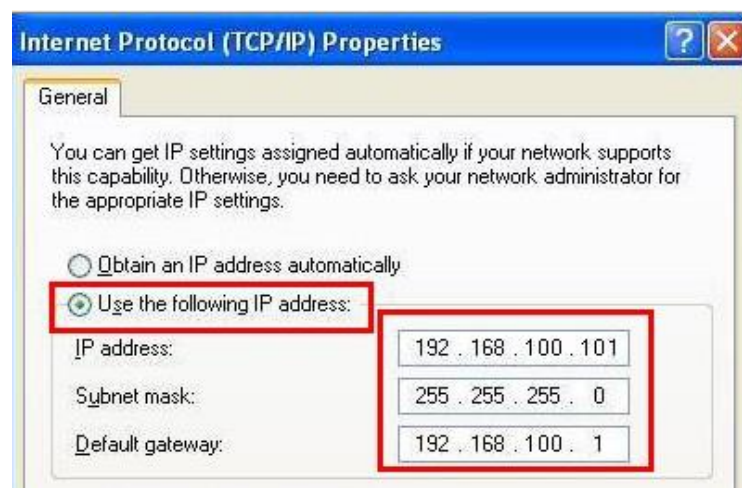

6.2 Using LumensCMS Software to View the Images

- Open **LUMENS CMS** software (Please download from the Lumens official website)
- Turn on the camera first and add the device to the software

<Description> Please refer to [LumensCMS software user manual](#) for related operation

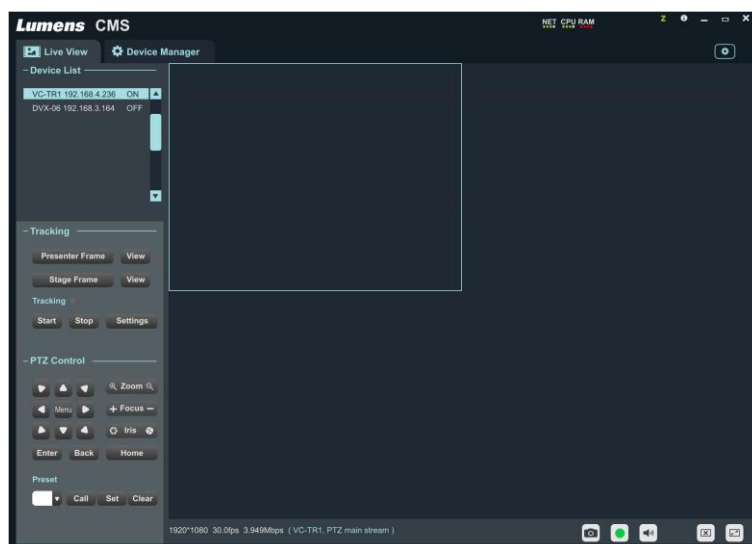

6.3 Using RTSP Player to View the Images

In addition to LumensCMS software, other free software also can be used for RTSP connection, such as Quick Time and PotPlayer.

RTSP connection address formats are as follows:

- PTZ screen: <rtsp://IP:554/ch01>, support up to 1080P60
- Panoramic screen: <rtsp://IP:554/ch02>, support up to 1080P30
- Preview screen: <rtsp://IP:554/ch03>, support up to 720P30

6.4 Get the VC-TR1 image by connecting the computer via USB

VC-TR1 can be connected to a PC via a USB cable as a USB video source, and used with a USB video conference system, such as AMCAP, Skype, and Zoom.

1. Turn the 4th pin of DIP Switch of Output Switch to ON (entering USB mode)
2. Open the USB video software, and select Lumens VC-TR1 Video Camera as the image source to get the VC-TR1 image

■ Example: Open AMCAP, select VC-TR1 as the image source of Devices

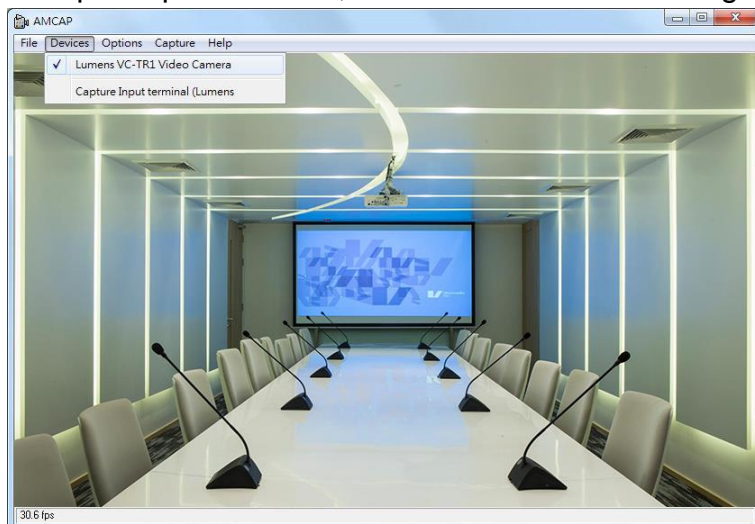

- Example: Enter Skype settings, go to audio and video page, and select VC-TR1 as the camera source

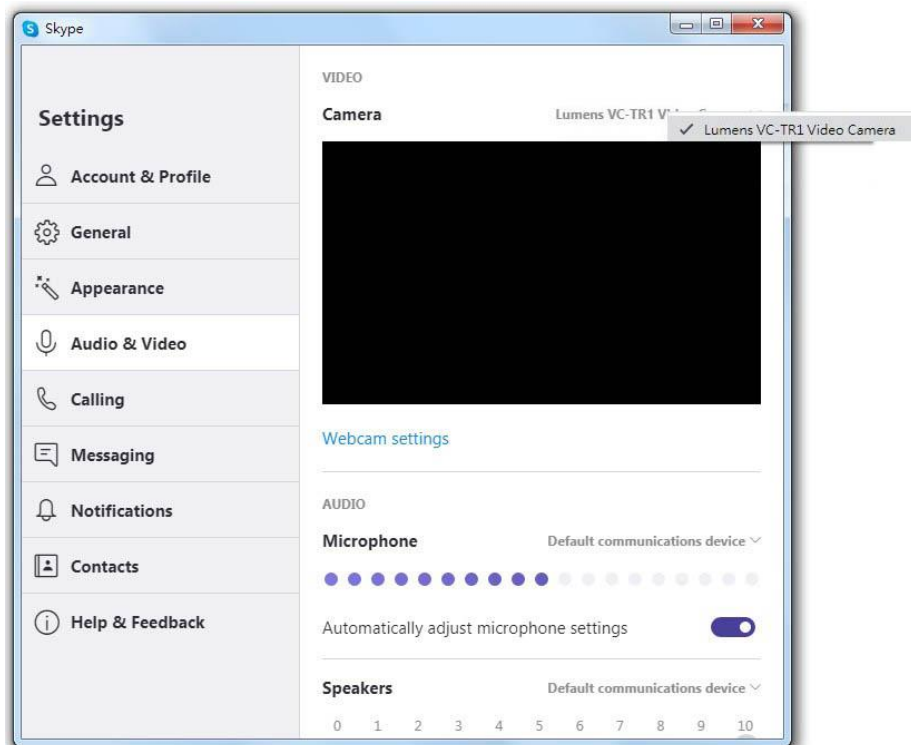



Chapter 7 DIP Switch Setting

7.1 OUTPUT SWITCH

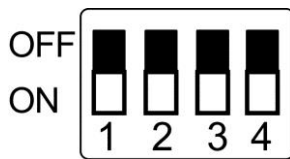
- The factory default is **MENU** (depend on the setting menu), and the default resolution of the setting menu is 1080p60
- The camera will restart 5 seconds after modifying the DIP
- To switch via the OSD/ RS-232 Command is also available based on the last executed action
- USB and IP may only choose one, because they cannot be output at the same time
- The Ethernet mode only defines the highest output frame rate of the streaming, but not determines the resolution and frame rate of the streaming
- Ethernet mode determines the output resolution and fps of HDMI/SDI

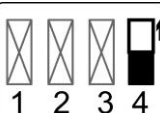
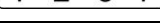
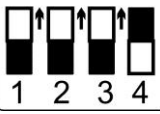
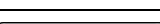
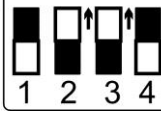
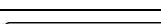
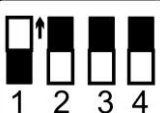
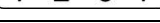
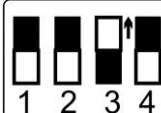
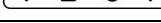
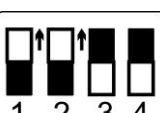
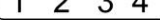
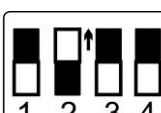
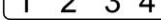

Mode	Format	SW	Format	SW
USB		OFF  ON 		
Ethernet	1080p60	OFF  ON 	1080p50	OFF  ON 
	1080p30	OFF  ON 	1080p25	OFF  ON 
	720p60	OFF  ON 	720p50	OFF  ON 
	MENU	OFF  ON 		

<Description> When all DIP are set to ON, the video resolution of the camera is determined by the setting menu

Chapter 8 Troubleshooting

This chapter describes problems you may encounter while using VC-TR1. If you have questions, please refer to related chapters and follow all the suggested solutions. If the problem still occurred, please contact your distributor or the service center.

No.	Problems	Solutions
1.	How to use USB output with computer video software	Please refer to Chapter 7 DIP Switch Setting to switch the USB output via DIP ※USB and Ethernet cannot be used at the same time, and only one can be selected as an output port at the same time
2.	Does it provide the Digital Zoom function?	Digital Zoom is enabled by default. The Digital Zoom function will be automatically turned off when the resolution is set to be 60 fps, and turned on automatically for 30 fps
3.	How to activate and stop the tracking function?	It can be activated and stopped via [Start]/[Stop] in the CMS software. In addition, F1/F2 on the remote control can be used to activate and stop the function
4.	What causes the loss of tracking?	Due to some limitations of the current tracking algorithm, the following situations need to be avoided: <ol style="list-style-type: none"> 1. Backlight environment 2. The tracking area may have people on TV, human-shaped billboards, face photos 3. Insufficient environmental brightness 4. Facial features are not obvious: such as wearing masks or sunglasses 5. The distance between the camera and the target exceeds the recommended setting value 6. The tracking target stands still for more than 1 minute
5.	The screen is not smooth during the tracking process	Make sure the Ratio Speed feature is activated. The PTZ speed is related to the current magnification. When it is turned on, the greater the magnification, the slower the PTZ speed
6.	When two targets appear on the screen, the wrong object is tracked	According to the tracking algorithm logic: The tracking function gives priority to face detection. If two targets appear in the tracking area at the same time during tracking, the wrong target may be tracked. Therefore, avoid two or more people in the tracking area at the same time, or use multi-person detection function

Appendix 1

1. Output specification table

HDMI/SDI	IP Stream (LumensCMS setting)		USB	
	IP Stream	Resolution	Resolution	FPS
1080P60	PTZ Main stream	1080P / 720P / D1 / QVGA	1920*1080	30
	Panoramic stream	1080P / 720P / D1 / QVGA	1280*720	
	Preview stream	720P / D1 / QVGA	640*480 320*240	
1080P50	PTZ Main stream	1080P / 720P / D1 / QVGA	1920*1080	25
	Panoramic stream	1080P / 720P / D1 / QVGA	1280*720	
	Preview stream	720P / D1 / QVGA	640*480 320*240	
1080P30	PTZ Main stream	1080P / 720P / D1 / QVGA	1920*1080	30
	Panoramic stream	1080P / 720P / D1 / QVGA	1280*720	
	Preview stream	720P / D1 / QVGA	640*480 320*240	
720P60	PTZ Main stream	1080P / 720P / D1 / QVGA	1280*720	30
	Panoramic stream	1080P / 720P / D1 / QVGA	640*480	
	Preview stream	720P / D1 / QVGA	320*240	
720P50	PTZ Main stream	1080P / 720P / D1 / QVGA	1280*720	25
	Panoramic stream	1080P / 720P / D1 / QVGA	640*480	
	Preview stream	720P / D1 / QVGA	320*240	

2. Function descriptions of special preset: Special preset cannot be used as general preset

Special preset	Function	Remark
80	Start tracking	
81	Stop tracking	
95	Enter or exit the setting menu	
96	Clear 0 - 64 preset	
99	Reboot the machine	
121	Output PTZ screen	HDMI/ SDI
122	Output panoramic screen	HDMI/ SDI
123	PTZ and panoramic PIP screen	HDMI/ SDI

Supplier's Declaration of Conformity 47 CFR § 2.1077 Compliance Information

Manufacturer : Lumens Digital Optics Inc.

Product Name : VC-TR1

Model Number : Auto Tracking Camera

Responsible Party – U.S. Contact Information

Supplier : Lumens Integration, Inc.

4116 Clipper Court, Fremont, CA 94538, United States

e-mail : support@mylumens.com

FCC Compliance Statement

This device complies with Part 15 of the FCC Rules. Operation is subject to the following two conditions : (1) This device may not cause harmful interference, and (2) this device must accept any interference received, including interference that may cause undesired operation.