

# PTZ-X20-IP

Full HD 20X Optical Zoom IP PTZ



V1.0

**AIDA**

# Table of Contents

|           |                                   |
|-----------|-----------------------------------|
| <b>1</b>  | Safety Guides                     |
| <b>2</b>  | Packing List & Quick Start        |
| <b>3</b>  | Product Highlights & Camera Specs |
| <b>5</b>  | Camera Interface & Dimension      |
| <b>6</b>  | IR Remote Controller              |
| <b>8</b>  | OSD Menu                          |
| <b>10</b> | Web Settings                      |
| <b>14</b> | VISCA Over IP                     |
| <b>15</b> | VISCA (RS-232) Port               |
| <b>16</b> | VISCA Protocol                    |
| <b>25</b> | UVC Control                       |
| <b>26</b> | Warranty & Support                |

# Safety Guide

1. Before operation, please read all of the instructions in the manual carefully. For your convenience, please keep this manual.
2. The camera power input range is 100-240VACv (50-60Hz). Ensure the power supply input is within this rate before powering on.
3. Camera power voltage = 12VDC, rated currency = 2A. We suggest you use it with the original power supply adapter supplied by the factory.
4. Please keep the power cable, video cable, and control cable in a safe place and out of obstructions.
5. Operational environment: 0°C-50°C/32°F-122°F, with humidity levels less than 90%. To avoid any damage, do no put or pour anything inside the camera.
6. Avoid weight stress, vibration, and pressure on the camera during transportation, storage, and installation.
7. Do not remove the camera housing and cover. For service, please contact our [support line](#).
8. Do not direct the camera towards strong/intensive light. Doing so could cause irreversible damage to the camera and void warranty.
9. Use a dry and soft cloth to clean the camera housing with a neutral cleaning agent, when needed. To avoid damage on the camera lens, do not use strong or abrasive cleaning agents on the camera housing.
10. Do not move the camera by moving the camera head. To avoid mechanical trouble, do not rotate the camera head by hand. Please refrain from moving the camera while it is in motion. Doing so could cause irreversible damage to the camera and void warranty.
11. Make sure the camera is on a fixed and smooth platform. Avoid any slanted placements unless bolted with the standard issued mount.
12. Power Supply Polarity Schematics:

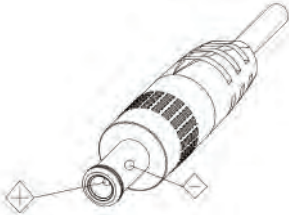

## ⚠ Warning:

Video quality can be affected by specific frequencies of electromagnetic field. Never grasp the head of the camera. Never move the camera by hand while is in motion. Doing so can damage the mechanism.

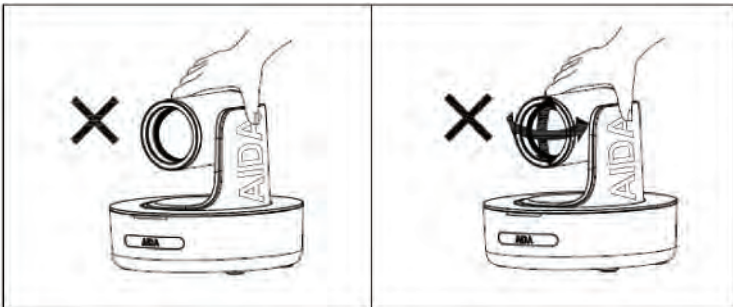

# Packing List

Check the items below, when opening the package:

**1**  
EA

- AIDA PTZ-X20-IP
- Power Adapter
- Power Cable
- RS-232 Control Cable
- USB 3.0 Cable
- Remote Control
- User Manual
- Double Sided Adhesive
- QC Certification
- Wall Mount

## Quick Start

1. Check that all cable connections are secure before powering on the camera.

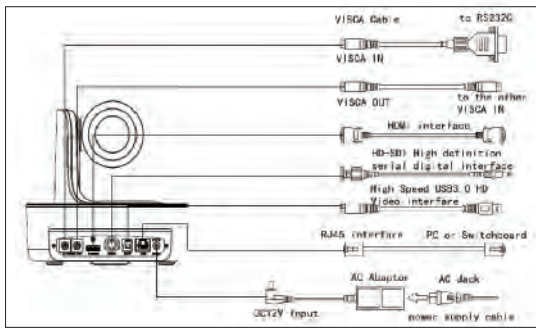

2. Dial Switch Setting (Used for Camera Updates):

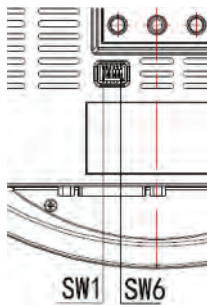

| Dial Switch (ARM) |      |      |                |
|-------------------|------|------|----------------|
|                   | SW-1 | SW-2 | Mode           |
| 1                 | OFF  | OFF  | Updating Mode  |
| 2                 | ON   | OFF  | Debugging Mode |
| 3                 | OFF  | ON   | Undefined      |
| 4                 | ON   | ON   | Working Mode   |

| Dial Switch |      |      |             |
|-------------|------|------|-------------|
|             | SW-3 | SW-4 | Instruction |
| 1           | OFF  | OFF  | Reserve     |
| 2           | ON   | OFF  | Reserve     |
| 3           | OFF  | ON   | Reserve     |
| 4           | ON   | ON   | Reserve     |

| Dial Switch (USB) |      |      |               |
|-------------------|------|------|---------------|
|                   | SW-5 | SW-6 | Instruction   |
| 1                 | OFF  | OFF  | Undefined     |
| 2                 | ON   | OFF  | Working Mode  |
| 3                 | OFF  | ON   | Updating Mode |
| 4                 | ON   | ON   | Undefined     |

# Product Highlights

- Contains an advanced Sony ISP (1/2.85" progressive CMOS sensor) providing 1920x1080 Ultra HD resolution.
- Wide angle optical lens: 20x optical zoom, with a standard 61° field of view.
- Full HD video over IP, via H.264 or H.265 encoding.
- Contains traditional outputs such as HDMI, SDI, USB 3.0, as well as RJ-45 for RTSP/RTMP streaming.
- Fully adjustable camera settings, such as White Balance, Exposure Settings, and Image Parameters.
- **Supports POE:** use a single CAT 5/6 cable to control and output video via the RJ-45 port.
- **Special Focusing Algorithm:** fast and precise focusing performance when zooming or moving the camera head.
- Smooth PTZ movements, as well as little to no motor sound when moving.
- Supports 10 presets via remote or 128 presets via RS-232 or online interface.
- Standard Sony Serial VISCA, IP VISCA protocol, as well as IP VISCA over UDP.
- Daisy chain is supported via the RS-232 input and output, controlling a maximum of 7 cameras.
- Menu based image parameters, including image flip for ceiling mounted cameras.
- Remote has multiple functions, such as fast switching video formats and ability to change IP address.
- Free firmware updates to keep the camera up to date with the latest and greatest!
- The USB 3.0 port is compatible with USB 2.0 and allows standard UVC 1.5 protocol for local control. UVC control works seamlessly with many well-known conferencing software.
- Supports multiple IR sensor compatibility, so you can use multiple remotes besides the issued one.
- OSD menu languages are in English and Spanish.

# Camera Specs

|              |              |  |
|--------------|--------------|--|
| Video Format | HDMI (V 1.4) | 1920 x 1080 60p/59.94p/50p/30p/29.97p/25p/24p/23.98<br>1920 x 1080 60i/59.94i/50i<br>1280 x 720 60p/59.94p/50p/30p/29.97p/25p  |
|              | SDI          | 1920 x 1080 60p/59.94p/50p/30p/29.97p/25p/24p/23.98<br>1920 x 1080 60i/59.94i/50i<br>1280 x 720 60p/59.94p/50p/30p/29.97p/25p  |
|              | USB          | 1920 x 1080 60p/50p/30p/25p (USB 3.0)<br>1280 x 720 60p/50p/30p (USB 3.0)<br>1280 x 720 25p (USB 3.0 & 2.0)<br>1024 x 576 30p (USB 3.0 & 2.0)<br>960 x 540 30p (USB 2.0)<br>640 x 360 30p (USB 2.0)<br>512 x 288 30p (USB 2.0) |
|              | RJ-45        | 1920 x 1080 @ 1~60    1280x 720 @ 1~60 (Main Stream)<br>1280 x 720 @ 1~60 / 1027 x 576 @ 1~60 / 640 x 360 @ 1~60 (Sub Stream)  |

# Camera Specs (CONTD)

|                    |  |
|--------------------|--|
| Video Interface    | HDMI (V 1.4) 3G-SDI, RJ-45, USB 3.0                                  |
| Sensor             | 1/2.85" Progressive CMOS sensor                                      |
| Zoom               | 20x Optical Zoom   |
| Lens               | F4.9~98mm (20x), F1.5-3.0, <b>View Angle:</b> 61°(Far)-3.2°(Near)    |
| Rotation Angle     | <b>Pan:</b> -170°~+170°; <b>Tilt:</b> -30°~+90°                      |
| Rotation Speed     | <b>Pan:</b> 0°~120°/s; <b>Tilt:</b> 0°~80°/s                         |
| Preset             | <b>Remote Controller:</b> 10 <b>RS-232:</b> 128                      |
| Control Port       | RS-232, RJ-45 (VISCA over IP), USB 3.0 (UVC 1.5), USB 2.0 (UVC 1.1)  |
| Network Speed      | 1000M  |
| Video Encode       | H.264/H.265 ( <b>default:</b> H.264)                                 |
| Bit Rate Control   | Variable Bit Rate, Constant Bit Rate                                 |
| Video Bit Rate     | 1024 kbps(min)~20480 kbps(max)                                       |
| IP Protocol        | IP, HTTP, RTSP, RTMP, DCHP, ONVIF, VISCA over IP (UDP)               |
| POE                | Supported (IEEE802.3af)  |
| Daisy Chain        | Support RS-232 serial daisy chain                                    |
| Minimum Lux        | 0.01 Lux   |
| White Balance      | Auto/Indoor/Outdoor/Manual/ATW/One Push/Fluorescent Lamp/Sodium Lamp |
| Exposure           | Auto/Manual/Bright/Shutter/Iris                                      |
| Focus              | Auto/Manual  |
| Iris               | Auto/Manual  |
| Gamma              | Supported  |
| WDR                | Supported  |
| BLC                | Supported  |
| 2D Noise Reduction | Supported  |
| 3D Noise Reduction | Supported  |
| Anti Flicker       | OFF/50Hz/60Hz  |
| Image Flip         | Supported  |
| Image Voltage      | DC12v/POE  |
| Dimension          | 220mm x 173mm x 190mm/8.66" x 6.81" x 7.48"                          |
| Net Weight         | 1.4kg/3.1lbs   |

# Camera Interface

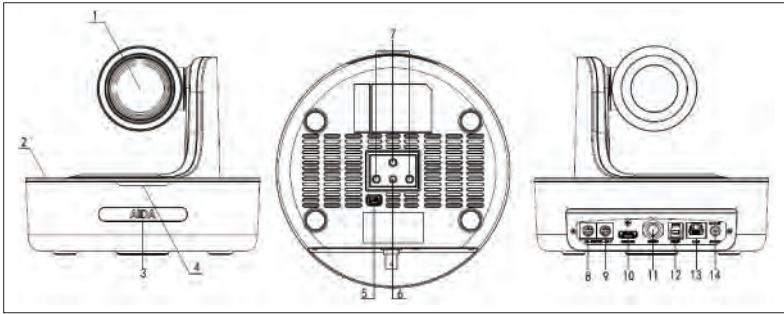

- |                           |                                 |                 |
|---------------------------|---------------------------------|-----------------|
| 1. Camera Lens            | 6. 1/4" Tripod Screw Hole       | 11. 3G-SDI Port |
| 2. Camera Base            | 7. Installation Hole            | 12. USB Port    |
| 3. IR Receiver Panel      | 8. RS-232 Control Port (Input)  | 13. RJ-45 Port  |
| 4. Power/Tally Light      | 9. RS-232 Control Port (Output) | 14. DC12V Plug  |
| 5. Dial Switch (Firmware) | 10. HDMI Port                   |                 |

# Camera Dimensions (in mm)

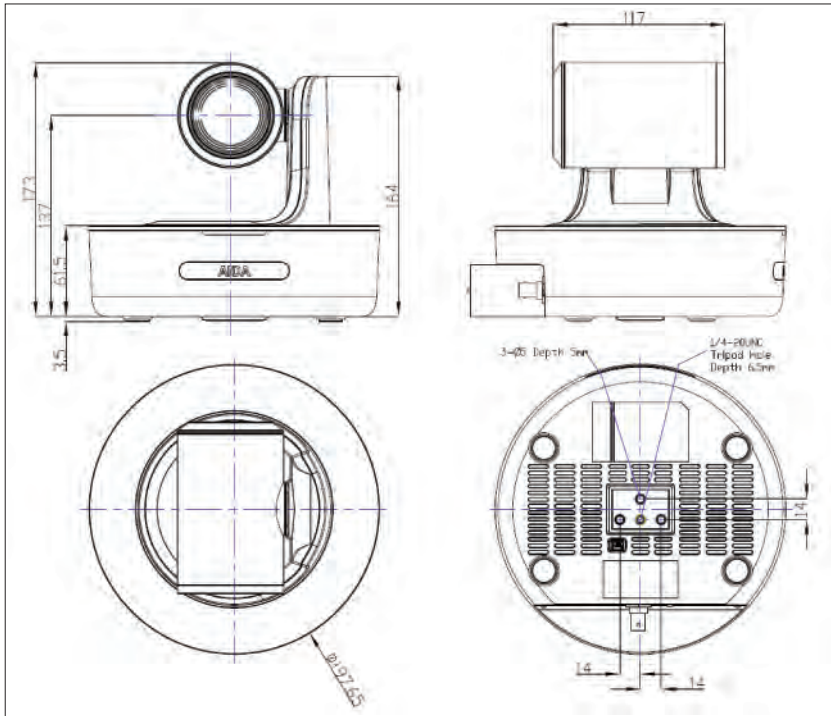

# IR Remote Controller



## Power

When powered on, pressing the power key enters standby mode; Pressing it again will start up the camera and display normally. If the camera was started up again, it will recall the last position that it was turned off on.

## Freeze (Not Supported)

The Freeze button has no function on the PTZ.

## IRT (IR Transfer/IR Pass)

Enables IR transfer. Once pressed, the camera will receive and pass IR remote control signal to the codec/terminal (via VISCA IN Port).



## SET 1~4 Address Setting

Hold the SET# button for 3 seconds to set the cameras IR address.

## CAM 1~4 (Camera selecting)

Pressing the CAM# button will enable IR control of the selected camera.

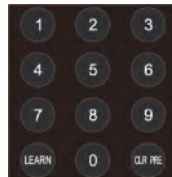

## Number Key (1-9)

**Set Preset:** To set preset, hold down a key (0-9) and wait 3 seconds. Once complete, the selected preset will be saved.

**Run Preset:** Pressing a key (0-9) will bring up the corresponding saved preset.

## CLR PRE (Clear Preset)

**Clear a Preset:** Press CLR PRE and key (0-9) simultaneously to remove the corresponding saved preset.

**Clear all Presets:** Hold down CLR PRE button to remove all saved presets.

## Learn

This button is used with other remote buttons. It has no function when pressed alone.



# IR Remote Controller (CONTD)



## Focus Key (+/-)

Allows for precise focus change. Manual focus mode must be enabled to use these keys.

## Zoom Key (+/-)

Optically zooms the camera in up to 12x.

## Navigate Key (Up/Down/Left/Right)

**Normal mode:** Allows for the camera head to pan and tilt.

**Menu mode:** Allows for direction in the menu of the camera.

## OK/Home Key

**Normal mode:** Recalls to the home position of the camera.

**Menu mode:** Used to set functions in the menu and activate features.



## AF (Auto Focus)

When enabled, the camera will automatically focus on the closest object.

## MF (Manual Focus)

When enabled, the camera will only focus when using one push focusing, or the focus keys on the remote.

## Reset

Factory resets image properties **only**.

## Menu

Used to enter the OSD menu of the camera.



## Limit L

Press this key with the Learn key to set the max **left** position of the camera.

## Limit R

Press this key with the Learn key to set the max **right** position of the camera.

## LMT CLR

Press this key with the Learn key to remove set max positions.



## BLC OFF/BLC ON

Not available.

## Bright + / Bright -

These buttons raise or lower the brightness of the image.



## Video Format Keys:

While directly pointing at the camera, please hold the desired video output button for 3 seconds. If done properly, the PTZ will do a quick reset in the desired video output selected.

# OSD MENU

1. When the camera is on, press the MENU key on the IR remote controller to enter the OSD Menu.
2. After entering the main menu, use the UP/DOWN navigate keys on the controller to select the main menu. As you scroll through the menu, the selection will be highlighted in blue.
3. Press the RIGHT navigate key to enter the highlighted sub menu. Use the UP/DOWN navigate keys to select within the sub menu. Use the LEFT/RIGHT navigate keys to enable or disable parameters.
4. To return to the previous menu, you need to press return in the sub menu or MENU on the remote. To fully leave the menu, press the MENU key again.
5. OSD Menu Setting List:

|          |                |   |                |
|----------|----------------|---|----------------|
| PTZF     | FOCUS MODE     | AUTO/MANUAL: Ability to change from auto or manual focus                  | DEFAULT: AUTO  |
|          | DIGITAL ZOOM   | ON/OFF: Ability to digitally zoom 2X.                                     | DEFAULT: OFF   |
|          | RATIO DISPLAY  | ON/OFF: Grants display of the zoom X module. Off by default.              | DEFAULT: OFF   |
|          | ZOOM SPEED     | Zoom speed control IR remote: 7 changeable levels.                        | DEFAULT: 5     |
|          | SPEED BY ZOOM  | When zoomed into the max, the camera will slowly tilt                     | DEFAULT: ON    |
|          | PAN/TILT SPEED | Pan/Tilt speed control by IR remote. Controllable at different levels     | DEFAULT: 18    |
|          | RETURN         | Return to previous menu.  |                |
|          | EXPOSURE MODE  | AUTO/MANUAL/BRIGHT/SHUTTER/IRIS: Choose the current Exp. Mode             | DEFAULT: AUTO  |
| EXPOSURE | SHUTTER        | Set shutter speed. 1/30-1/10000: Allows for tuning of the shutter speed   | DEFAULT: AUTO  |
|          | IRIS           | Set Iris: CLOSE-F1.8: Allows for tuning of the Iris opening.              | DEFAULT: AUTO  |
|          | GAIN           | Set gain: 0dB-28dB: Allows for tuning the gain of the camera              | DEFAULT: AUTO  |
|          | BRIGHTNESS     | Set brightness: 0-15: Allows for tuning the brightness of the camera      | DEFAULT: AUTO  |
|          | FLICK          | Allows for adjustment of the flickerless options on the camera            | DEFAULT: 50Hz  |
|          | BLACKLIGHT     | Allows for the enabling of the blacklight or not.                         | DEFAULT: OFF   |
|          | GAMMA          | Allows setting changes for the Gamma option of the camera                 | DEFAULT: 0     |
|          | RETURN         | Return to previous menu   |                |
| IMAGE    | WB MODE        | AUTO/INDOOR/OUTDOOR/PUSH/ATW/MANUAL/SODIUM                                | DEFAULT: ATW   |
|          | BLUE           | Set red gain level: 0-255 (Allows for precise tuning of the blue setting) | DEFAULT: AUTO  |
|          | RED            | Set blue gain level: 0-255 (Allows for precise tuning of the red setting) | DEFAULT: AUTO  |
|          | DEFOG          | Set defog level: This setting allows you to clear up the hazy images      | DEFAULT: 0     |
|          | MIRROR         | ON/OFF: Makes the image flip on the vertical plane                        | DEFAULT: OFF   |
|          | FLIP           | ON/OFF: (optional) Makes the image flip on the horizontal plane           | DEFAULT: OFF   |
|          | COLOR/B&W      | COLOR/B&W: Allows for B&W color mode                                      | DEFAULT: COLOR |
|          | GAIN LIMIT     | Allows you to cap the gain at a certain level                             | DEFAULT: 15    |
|          | RETURN         | Return to previous menu   |                |

# OSD MENU (CONTD)

|         |                 |  |  |
|---------|-----------------|--|--|
| QUALITY | 2DNR            | When enabled, image noise and sharpness is reduced                 | DEFAULT: OFF                                       |
|         | 3DNR            | OFF/AUTO/0-4 optional: higher level = less image reduction happens | DEFAULT: AUTO                                      |
|         | SHARPNESS       | ON/OFF optional, 0-15 level: higher level = sharper edges of image | DEFAULT: 6   |
|         | CONTRAST        | Set contrast level: 0-15: Sets the contrast level                  | DEFAULT: 8   |
|         | SATURATION      | Set image saturation: 0-15: Sets the saturation level              | DEFAULT: 8   |
|         | BRIGHTNESS      | Set brightness of auto exposure: 0-15: Sets the brightness level   | DEFAULT: 8   |
|         | WDR             | ON/OFF: Enables better to light and dark images                    | DEFAULT: OFF                                       |
|         | WDR LEVEL       | 1-6: Enables more control of WDR                                   | DEFAULT: 1   |
|         | RETURN          | Return to previous menu  |  |
| FORMAT  | SIZE            | 1080p/1080i/720p (default resolution: 1080 30p)                    | After selecting format, press OK to switch format. |
|         | FRAME RATE      | 60/59.94/50/30/29.97/25/24/23.98                                   |  |
|         | RETURN          | Return to previous menu  |  |
| SYSTEM  | ID              | Set VISCA control address 1-7                                      | DEFAULT: 1   |
|         | BAUDRATE        | Set RS-232 baud rate to 2400/4800/9600/115200                      | DEFAULT: 9600                                      |
|         | LANGUAGE/IDIOMA | Set language: ENGLISH/SPANISH                                      | DEFAULT: ENG                                       |
|         | DHCP            | IP address automatic acquisition switch: ON/OFF                    | DEFAULT: OFF                                       |
|         | IP              | Set camera IP  | 192.168.1.188                                      |
|         | NET MASK        | Set camera net mask  | 255.255.255.0                                      |
|         | GATEWAY         | Set camera gateway   | 192.168.1.1  |
|         | RETURN          | Return to previous menu  |  |
| INFO    | IP ADDRESS      | Display the current IP address                                     |  |
|         | RTSP URL        | Display the current main stream RTSP URL                           |  |
|         | F/W VERSION     | Display the current ISP firmware version                           |  |
|         | ARM VERSION     | Display the current ARM firmware version                           |  |
|         | FPGA VERSION    | Display the current FPGA firmware version                          |  |
|         | USB VERSION     | Display the current USB firmware version                           |  |
| RESET   | FACTORY RESET   | Reset whole camera to factory parameters                           |  |
|         | USER SETTING    | Save current parameters for User Reset use                         |  |
|         | USER RESET      | Recalls the saved user settings                                    |  |
|         | RETURN          | Return to previous menu  |  |

# Web Settings

The camera's web interface supports Google Chrome, Firefox, IE, Safari, Opera, and other major browsers. When using the IP camera via web browser for the first time, you need to install Flash Player to view the camera preview. We suggest downloading it from the official Flash website to get the latest version at [Adobe.com/products/flashruntimes](http://Adobe.com/products/flashruntimes).

## 1. Login

Open your browser and in the address bar, type in the camera's default IP address: **192.168.1.188** (If that doesn't work please check in the camera's menu to see the actual IP address under INFO)

Next, enter the username and password. The default for both is **admin**. (If that doesn't work, please factory reset the camera to reset the password)

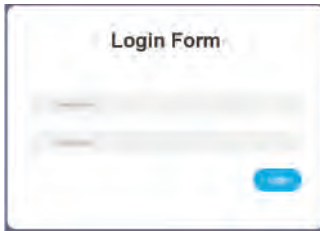

## 2. Real-time Preview

When logging in the first time, an error may appear like below. The reason is due to the browser blocking flash from running. To fix this, click the button above the preview screen labeled "click to download Flash Player." Once done, a dialog box will appear like seen below. Click "allow" and you should see the camera preview.



As seen, the control interface is on the right. You can control the camera's movements with the movement pad at the top, as well as control zoom and focus. You can also set the movement, focus, and zoom speed, as well being able to control your presets.

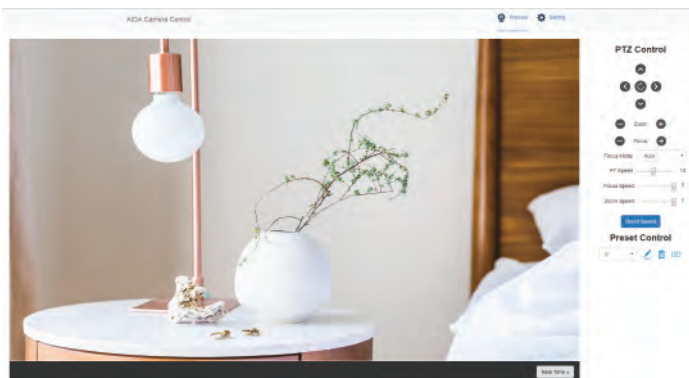

# Web Settings (CONTD)

## 3. Parameter Settings

Click "**Setting**" to enter the parameter setting interface as seen below:

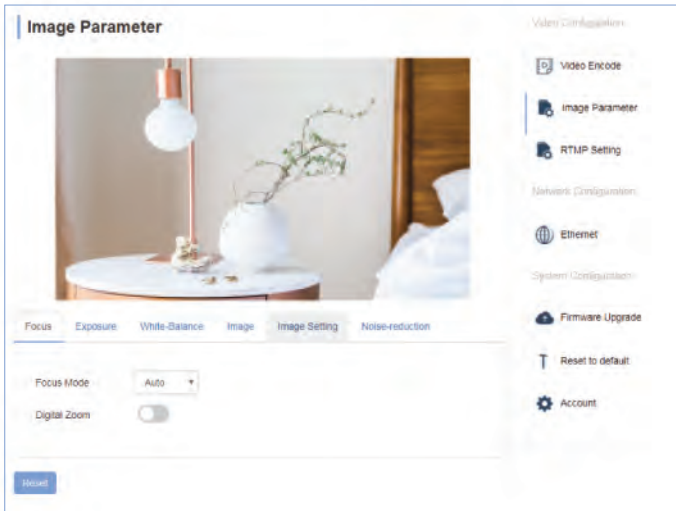

Under "**Video Encode**", you can enable the RTSP/RTMP streams for both the main and sub streams. You may also change the Encode mode, choosing between H.264 or H.265. Lastly, you can change the framerate and bitrate for each stream on this menu.

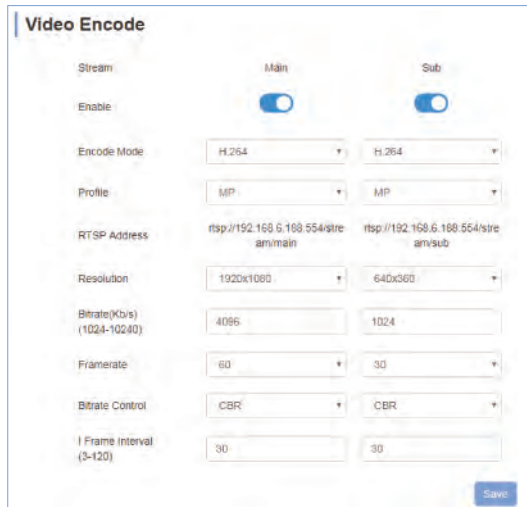

# Web Settings (CONTD)

"*Image Parameter*" is the online version of the OSD Menu. You can change the same settings via browser.

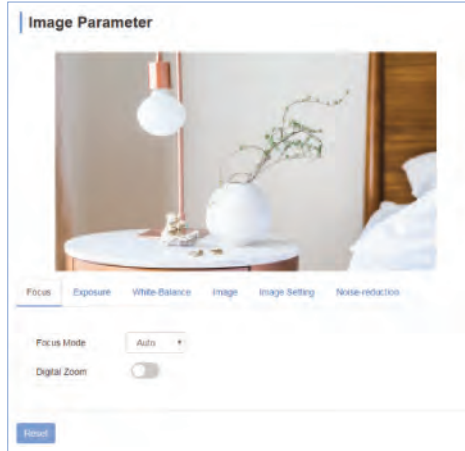

"*RTMP Setting*" allows you to directly stream to many social platforms such as Youtube & Facebook Live. Here you can place the RTMP address, as well as enable the RTMP stream. To do this, you must:

- 1st:** First obtain the live RTMP address (for youtube, it is `rtmp://a.rtmp.youtube.com/live2`). You will also need your **stream key**.
- 2nd:** Place the live RTMP address in the Main RTMP address box.
- 3rd:** Next, ensure that there is a forward slash (/) after the RTMP address. If there is already a forward slash, please skip this step.
- 4th:** Lastly, paste your stream key after the forward slash(/).
- 5th:** Click Save

Once you complete these steps, your PTZ will immediately start uploading to your social platforms channel. You will see a blue checkmark next to the RTMP state, which will show if your RTMP address is correctly inputted. No reboot required!

Custom RTMP stream keys also allows you to make your own RTMP address and pull that stream from other programs. If you are stuck on any of these steps, contact our **support**. They will be glad to assist you in any problems you may encounter.

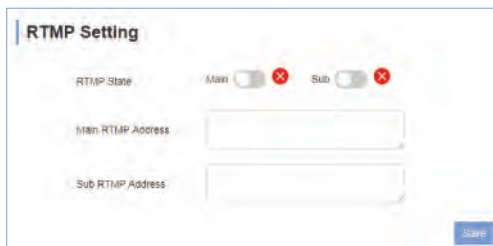

# Web Settings (CONTD)

"**Ethernet**" allows for fine tuning if the IP portion of the camera. You can enable DHCP for auto IP configuration.

|                 |               |           |      |
|-----------------|---------------|-----------|------|
| DHCP            | OFF           | HTTP Port | 80   |
| IP address      | 192.168.1.188 | RTSP Port | 554  |
| Subnet Mask     | 255.255.255.0 | RTMP Port | 1935 |
| Default Gateway | 192.168.1.1   |           |      |

To **upgrade the firmware** on our PTZ, head over to our website at [aidaimaging.com/download](http://aidaimaging.com/download) and look for the latest PTZ firmware.

The "**Reset to default**" portion allows you to factory reset image parameter reset, or reboot the camera.

**Simple Reset:** Only resets customizable camera options: AE, WB, Image Effects, etc.

**Complete Reset:** Factory resets the camera, including the IP address

**Reboot:** Reboot ISP portion of the camera.



"**Account Settings**" is used to change the log in for the account. You can change the username and password here.



# VISCA over IP

The PTZ-X20-IP uses VISCA over IP protocol to reliably send and receive information from IP controllers.

Communication port specs:

- **Control port:** RJ-45 Gigabit LAN
- **IP Protocol:** IPv4
- **Transmit Protocol:** UDP
- **IP address:** Default **192.168.1.188** (check OSD menu)
- **Port address:** 52381
- **Confirm send/transmission control:** Depends on software

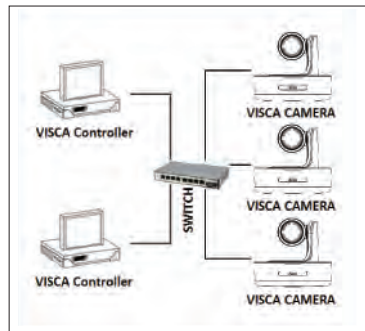

## What is VISCA over IP?

VISCA commands are the communication between the controller and the camera equipment. These commands are sent via UDP on the network. Since UDP transmission isn't that stable, a couple of steps must happen before a movement is executed. The controller first sends out a VISCA command. The camera equipment then receives the VISCA command and returns that message back to the controller. Once the commands are executed, the action will follow suit and the message will be complete. Each VISCA command controls its own setting, so there are no overlaps in existing commands.



# VISCA IN (RS-232 Port)

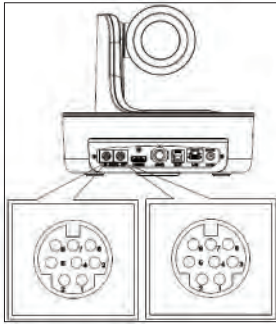

|   |        |
|---|--------|
| 1 | DTR    |
| 2 | DSR    |
| 3 | TXD    |
| 4 | GND    |
| 5 | RXD    |
| 6 | A      |
| 7 | IR OUT |
| 8 | B      |

## VISCA IN & Mini DIN Connection

| Camera VISCA IN |        | Mini DIN |     |
|-----------------|--------|----------|-----|
| 1               | DTR    | 1        | DSR |
| 2               | DSR    | 2        | DTR |
| 3               | TXD    | 5        | RXD |
| 4               | GND    | 4        | GND |
| 5               | RXD    | 3        | TXD |
| 6               | A(+)   | 6        | NC  |
| 7               | IR OUT | 7        | NC  |
| 8               | B(-)   | 8        | NC  |

## VISCA IN & DB9 Connection

| Camera VISCA IN |        | Windows DB9 |     |
|-----------------|--------|-------------|-----|
| 1               | DTR    | 6           | DSR |
| 2               | DSR    | 4           | DTR |
| 3               | TXD    | 2           | RXD |
| 4               | GND    | 5           | GND |
| 5               | RXD    | 3           | TXD |
| 6               | A(+)   |             |     |
| 7               | IR OUT |             |     |
| 8               | B(-)   |             |     |

# Serial Port Configuration

| Parameter | Value                 | Parameter | Value |
|-----------|-----------------------|-----------|-------|
| Baud Rate | 2400/4800/9600/115200 | Stop Bit  | 1 Bit |
| Start Bit | 1 Bit                 | Check Bit | None  |
| Date Bit  | 8 Bit                 |           |       |

# VISCA Protocol

## Part 1: Camera Return Command

| ACK/Completion Message |                |   |
|------------------------|----------------|---|
|                        | Command Packet | Note  |
| ACK                    | z0 41 FF       | Returned when the command is accepted       |
| Completion             | z0 51 FF       | Returned when the command has been executed |

z = camera address +8

| Error Messages         |                |   |
|------------------------|----------------|---|
|                        | Command Packet | Note  |
| Syntax Error           | z0 60 02 FF    | Returned when the command format is different or when a command with illegal command parameters is accepted   |
| Command Not Executable | z0 61 41 FF    | Returned when the command cannot be executed due to current conditions. For example, when commands controlling the focus manually are received during auto focus. |

## Part 2: Camera Control Command

|               |                   |                               |  |
|---------------|-------------------|-------------------------------|--|
| AddressSet    | Broadcast         | 88 30 01 FF                   | Address setting  |
| IF_Clear      | Broadcast         | 88 01 00 01 FF                | I/F Clear  |
| CommandCancel |                   | 8x 21 FF                      |  |
| CAM_Power     | On                | 8x 01 04 00 02 FF             | Power ON/OFF   |
|               | Off               | 8x 01 04 00 03 FF             |  |
| CAM_Zoom      | Stop              | 8x 01 04 07 00 FF             |  |
|               | Tele(Standard)    | 8x 01 04 07 02 FF             |  |
|               | Wide(Standard)    | 8x 01 04 07 03 FF             |  |
|               | Tele(Variable)    | 8x 01 04 07 2p FF             | p=0(low)-7(high)   |
|               | Wide(Variable)    | 8x 01 04 07 3p FF             |  |
|               | Direct            | 8x 01 04 47 0p 0q 0r 0s FF    | pqrs: Zoom Position (0 (wide)-0x4000(tele))              |
|               | Direct with speed | 8x 0A 04 47 0t 0p 0q 0r 0s FF | t: spd 0-7<br>pqrs: Zoom Position (0(wide)-0x4000(tele)) |
| CAM_DZoom     | ON                | 8x 01 04 06 02 FF             |  |
|               | OFF               | 8x 01 04 06 03 FF             |  |
|               | Combine Mode      | 81 01 04 36 00 FF             | Combine with optical zoom control                        |
|               | Separate Mode     | 81 01 04 36 01 FF             | Separate with optical zoom control                       |

# VISCA Protocol (CONTD)

|               |                   |  |   |
|---------------|-------------------|--|---|
| CAM_DZoom     | Stop              | 81 01 04 06 00 FF                      | Enable in separate mode   |
|               | Tele(Variable)    | 81 01 04 06 2p FF                      | Enable in separate mode   |
|               | Wide(Variable)    | 81 01 04 06 3p FF                      | Enable in separate mode   |
|               | Direct            | 81 01 04 46 0p 0q 0r 0s FF             | Enable in separate mode   |
| CAM_Focus     | Stop              | 8x 01 04 08 00 FF                      |   |
|               | Far(Standard)     | 8x 01 04 08 02 FF                      |   |
|               | Near(Standard)    | 8x 01 04 08 03 FF                      |   |
|               | Far(Variable)     | 81 01 04 08 2p FF                      | p=0 (Low) to 7 (High)   |
|               | Near (Variable)   | 81 01 04 08 3p FF                      | p=0 (Low) to 7 (High)   |
|               | Direct            | 8x 01 04 48 0p 0q 0r 0s FF             | pqrs: Focus Position  |
|               | Auto Focus        | 81 01 04 38 02 FF                      |   |
|               | Manual Focus      | 81 01 04 38 03 FF                      |   |
| One Push AF   | 8x 01 04 18 01 FF |  |   |
| CAM_ZoomFocus | Direct            | 8x 01 04 47 0p 0q 0r 0s 0t 0u 0v 0w FF | pqrs: Zoom Position (0(wide)--0x4000(tele))<br>tuvw: Focus Position |
| CAM_WB        | Auto              | 8x 01 04 35 00 FF                      |   |
|               | Indoor            | 8x 01 04 35 01 FF                      |   |
|               | Outdoor           | 8x 01 04 35 02 FF                      |   |
|               | One Push          | 8x 01 04 35 03 FF                      |   |
|               | ATW               | 8x 01 04 35 04 FF                      |   |
|               | Manual            | 8x 01 04 35 05 FF                      |   |
|               | Sodium lamp       | 8x 01 04 35 08 FF                      |   |
|               | Flourescent       | 8x 01 04 35 09 FF                      |   |
|               | One Push Trigger  | 8x 01 04 10 05 FF                      |   |
| CAM_RGain     | Reset             | 8x 01 04 03 00 FF                      |   |
|               | Up                | 8x 01 04 03 02 FF                      | Manual Control of RGain   |
|               | Down              | 8x 01 04 03 03 FF                      |   |
|               | Direct            | 8x 01 04 43 00 00 0p 0q FF             | pq: RGain (0-0xFF)  |
| CAM_BGain     | Reset             | 8x 01 04 04 00 FF                      |   |
|               | Up                | 8x 01 04 04 02 FF                      | Manual Control of BGain   |
|               | Down              | 8x 01 04 04 03 FF                      |   |
|               | Direct            | 8x 01 04 44 00 00 0p 0q FF             | pq: BGain (0-0xFF)  |

# VISCA Protocol (CONTD)

|                        |                  |                            |  |
|------------------------|------------------|----------------------------|--|
| CAM_AE                 | Full Auto        | 81 01 04 39 00 FF          | Automatic Exposure mode  |
|                        | Manual           | 81 01 04 39 03 FF          | Manual Control mode  |
|                        | Shutter Priority | 81 01 04 39 0A FF          | Shutter Priority<br>Automatic Exposure mode                      |
|                        | Iris Priority    | 81 01 04 39 0B FF          | Iris Priority Automatic<br>Exposure mode                         |
|                        | Bright           | 81 01 04 39 0D FF          | Bright Mode (Manual control)                                     |
| CAM_Shutter            | Reset            | 8x 01 04 0A 00 FF          | Shutter Setting  |
|                        | Up               | 8x 01 04 0A 02 FF          |  |
|                        | Down             | 8x 01 04 0A 03 FF          |  |
|                        | Direct           | 8x 01 04 4A 00 00 0p 0q FF | pq: Shutter Position (0-0x15)                                    |
| CAM_Iris               | Reset            | 8x 01 04 0B 00 FF          | Iris Setting (0-0x0D)  |
|                        | Up               | 8x 01 04 0B 02 FF          |  |
|                        | Down             | 8x 01 04 0B 03 FF          |  |
|                        | Direct           | 8x 01 04 4B 00 00 0p 0q FF | pq: Iris Position (0-0x0D)                                       |
| CAM_Gain               | Reset            | 8x 01 04 0C 00 FF          | Gain Setting (0-0x0E)  |
|                        | Up               | 8x 01 04 0C 02 FF          |  |
|                        | Down             | 8x 01 04 0C 03 FF          |  |
|                        | Direct           | 8x 01 04 0C 00 00 0p 0q FF | pq: Gain Position (0-0x0E)                                       |
| CAM_Bright             | Reset            | 8x 01 04 0D 00 FF          | Bright Setting   |
|                        | Up               | 8x 01 04 0D 02 FF          |  |
|                        | Down             | 8x 01 04 0D 03 FF          |  |
|                        | Direct           | 8x 01 04 4D 00 00 0p 0q FF | pq: Bright Position (0-0x1B)                                     |
| CAM_ImageBright        | Direct           | 8x 01 04 A4 00 00 0p 0q FF | pq: Image Bright Position (0-0x0F)<br>AE_AUTO/AE_SHUTTER/AE_IRIS |
| CAM_WDR                | On               | 8x 01 04 3D 02 FF          | Exposure Compensation ON/OFF                                     |
|                        | Off              | 8x 01 04 3D 03 FF          |  |
|                        | Direct           | 8x 01 04 D3 pq FF          | pq: ExpComp Position (0-0x6)                                     |
| CAM_Backlight<br>(BLC) | On               | 8x 01 04 33 02 FF          | Backlight On   |
|                        | Off              | 8x 01 04 33 03 FF          | Backlight Off  |
| CAM_Sharpness          | Reset            | 8x 01 04 02 00 FF          | Aperture Control   |
|                        | Up               | 8x 01 04 02 02 FF          |  |
|                        | Down             | 8x 01 04 02 03 FF          |  |
|                        | Direct           | 8x 01 04 42 00 00 0p 0q FF | pq: Aperture Gain (0-0x0F)                                       |

# VISCA Protocol (CONTD)

|                        |            |                            |   |
|------------------------|------------|----------------------------|---|
| CAM_Memory<br>(preset) | Reset      | 8x 01 04 3F 00 0p FF       | p: Preset Number (=0 to 128)<br>Corresponds to 0-9 on the remote controller |
|                        | Set        | 8x 01 04 3F 01 0p FF       |   |
|                        | Recall     | 8x 01 04 3F 02 0p FF       |   |
| CAM_LR_Reverse         | 0n         | 8x 01 04 61 02 FF          | Image Flip Horizontal 0n/0ff  |
|                        | 0ff        | 8x 01 04 61 03 FF          |   |
| CAM_PictureFlip        | 0n         | 8x 01 04 66 02 FF          | Image Flip Horizontal 0n/0ff  |
|                        | 0ff        | 8x 01 04 66 03 FF          |   |
| CAM_RS485Ctl           | 0n         | 8x 01 06 A5 02 FF          |   |
|                        | 0ff        | 8x 01 06 A5 03 FF          |   |
| CAM_Saturation         | Saturation | 8x 01 04 A1 00 00 0p 0q FF | pq: Saturation Level 0x00~0xff  |
| CAM_Contrast           | Contrast   | 8x 01 04 A2 00 00 0p 0q FF | pq: Contrast Level 0x00~0xff  |
| CAM_SpeedByZoom        | 0n         | 8x 01 06 A0 02 FF          |   |
|                        | 0ff        | 8x 01 06 A0 03 FF          |   |
| CAM_PTSpeed            | PT Speed   | 8x 01 04 C1 00 00 0p 0q FF | pq: PT Speed 0x05~0x18  |
| CAM_ZoomSpeed          | Zoom Speed | 8x 01 04 D1 00 00 0p 0q FF | pq: Zoom Speed 0x01~0x07  |
| CAM_ZoomDisplay        | 0n         | 8x 01 06 C2 02 FF          |   |
|                        | 0ff        | 8x 01 06 C2 03 FF          |   |
| CAM_IRaddress          | IR address | 8x 01 06 D8 0p FF          | p: IR address1~4  |
| CAM_Gamma              | Gamma set  | 81 01 04 5B 0p FF          | p: Gamma No. (0~4)  |
| CAM_ColorGain          | Direct     | 8x 01 04 49 00 00 0p 0p FF | (0~0x0E)  |
| CAM_2DNR               | Direct     | 8x 01 04 A5 0p FF          | (0~0x1)   |
| CAM_3DNR               | Direct     | 8x 01 04 53 0p FF          | (0~0x05)  |
| FLICK                  | 50Hz       | 81 01 04 23 01 FF          |   |
|                        | 60Hz       | 81 01 04 23 02 FF          |   |
|                        | OFF        | 81 01 04 23 00 FF          |   |

# VISCA Protocol (CONTD)

|                        |                        |   |   |
|------------------------|------------------------|---|---|
| VideoSystem Set (AIDA) |                        | 8x 01 06 35 00 pp FF                      | <p><b>pp:</b></p> <p>1080P60 0x00<br/> 1080P50 0x01<br/> 1080I60 0x02<br/> 1080I50 0x03<br/> 1080P30 0x 04<br/> 1080P25 0x05<br/> 720P60 0x 06<br/> 720P50 0x07<br/> 720P30 0x08<br/> 720P25 0x09<br/> 1080P5994 0x0E<br/> 1080I5994 0x0F<br/> 1080P2997 0x10<br/> 720P5994 0x13<br/> 720P2997 0x14<br/> 1080P24 0x11<br/> 1080P2398 0x12</p> <p><b>Video Format:</b></p> |
| VideoSystem Set (Sony) |                        | 81 01 04 24 72 0p 0q FF                   | <p><b>pp:</b></p> <p>1080P60 0x2e<br/> 1080P50 0x2f<br/> 1080I60 0x01<br/> 1080I50 0x04<br/> 1080P30 0x06<br/> 1080P25 0x08<br/> 720P60 0x09<br/> 720P50 0x0c<br/> 720P30 0x0e<br/> 720P25 0x11<br/> 1080P5994 0x13<br/> 1080I5994 0x02<br/> 1080P2997 0x07<br/> 720P5994 0x0a<br/> 720P2997 0x0f<br/> 1080P24 0x2a<br/> 1080P2398 0x2b</p> <p><b>Video Format:</b></p>   |
| CAM_IDWrite            |                        | 8x 01 04 22 0p 0q 0r 0s FF                | <b>pqrs:</b> Camera ID (=0000 to FFFF)  |
| DHCP control           | DHCP off               | 8x 01 04 AE 00 FF                         | DHCP off  |
|                        | DHCP on                | 8x 01 04 AE 01 FF                         | DHCP on   |
| Main Stream            | Resolution             | 8x 01 04 C2 00 0p 0q 0r 0s 0m 0n 0x 0y FF | <b>pqrs:</b> Column(x size) <b>mnxy:</b> Line (y size)<br><b>only support:</b> 1920x1080/1280x720   |
|                        | Rate                   | 8x 01 04 C2 01 0p 0q 0r 0s 0m 0n 0x 0y FF | <b>pqrsmnxy:</b> bitrate (0-15360)  |
| Sub Stream             | Resolution             | 8x 01 04 C3 00 0p 0q 0r 0s 0m 0n 0x 0y FF | <b>pqrs :</b> Column(x size) <b>mnxy:</b> Line (y size)<br><b>only support:</b> 1280x720/1024x576/640x360   |
|                        | Rate                   | 8x 01 04 C3 01 0p 0q 0r 0s 0m 0n 0x 0y FF | <b>pqrsmnxy:</b> bitrate (0-15360)  |
| Tally Control          | Off                    | 8x 01 7E 01 0A 00 0p FF                   | <b>p:</b> 0: OFF(LED off) 1: (LED green on)<br>2: (LED red on) 4: (LED blue on)   |
| IP address control     | IP Set                 | 8x 01 04 AB 0p 0q 0r 0s 0m 0n 0x 0y FF    | Set ip to : <b>pq.rs.mn.xy</b>  |
|                        | Mask                   | 8x 01 04 AC 0p 0q 0r 0s 0m 0n 0x 0y FF    | Set mask to : <b>pq.rs.mn.xy</b>  |
|                        | Gateway set            | 8x 01 04 AD 0p 0q 0r 0s 0m 0n 0x 0y FF    | Set gateway to : <b>pq.rs.mn.xy</b>   |
| Color adjust           | Color Adjust OFF       | 8x 01 04 B6 00 FF                         | Color adjust off  |
|                        | Color Adjust ON        | 8x 01 04 B6 01 FF                         | Color adjust on   |
|                        | Brightness Balance OFF | 8x 01 04 B7 00 FF                         | Keep Brightness   |
|                        | Brightness Balance ON  | 8x 01 04 B7 01 FF                         | Don't Keep Brightness   |

# VISCA Protocol (CONTD)

|                   |                   |  |   |
|-------------------|-------------------|--|---|
| Color adjust      | Flare red         | 8x 01 04 B8 dat FF                           | Flare mode red value (Default= <b>32</b> )  |
|                   | Flare green       | 8x 01 04 B9 dat FF                           | Flare mode green value (Default= <b>32</b> )  |
|                   | Flare blue        | 8x 01 04 BA dat FF                           | Flare mode blue value (Default= <b>32</b> )   |
| SYS_Menu          | Menu On           | 8x 01 06 06 02 FF                            | Turn on menu  |
|                   | Menu Off          | 8x 01 06 06 03 FF                            | Turn off menu   |
|                   | Menu Back         | 8x 01 06 06 10 FF                            | Menu step back  |
|                   | Menu Ok           | 8x 01 7E 01 02 00 01 FF                      | Menu ok   |
| IR_Receive        | On                | 8x 01 06 08 02 FF                            | IR(remote commander)receive ON/OFF  |
|                   | Off               | 8x 01 06 08 03 FF                            |   |
|                   | On/Off            | 8x 01 06 08 10 FF                            |   |
| Pan_TiltDrive     | Up                | 8x 01 06 01 VV WW 03 01 FF                   | <p><b>VV</b>: Pan speed 0x01 (low speed) to 0x18 (high speed)</p> <p><b>WW</b>: Tilt speed 0x01 (low speed) to 0x14 (high speed)</p> <p><b>YYYY</b>: Pan Position(TBD)</p> <p><b>ZZZZ</b>: Tilt Position(TBD)</p> |
|                   | Down              | 8x 01 06 01 VV WW 03 02 FF                   |   |
|                   | Left              | 8x 01 06 01 VV WW 01 03 FF                   |   |
|                   | Right             | 8x 01 06 01 VV WW 02 03 FF                   |   |
|                   | Upleft            | 8x 01 06 01 VV WW 01 01 FF                   |   |
|                   | Upright           | 8x 01 06 01 VV WW 02 01 FF                   |   |
|                   | Downleft          | 8x 01 06 01 VV WW 01 02 FF                   |   |
|                   | Downright         | 8x 01 06 01 VV WW 02 02 FF                   |   |
|                   | Stop              | 8x 01 06 01 VV WW 03 03 FF                   |   |
|                   | Absolute Position | 8x 01 06 02 VV WW 0Y 0Y 0Y 0Z 0Z 0Z 0Z FF    |   |
|                   | Relative Position | 8x 01 06 03 VV WW 0Y 0Y 0Y 0Y 0Z 0Z 0Z 0Z FF |   |
|                   | Home              | 8x 01 06 04 FF                               |   |
| Reset             | 8x 01 06 05 FF    |  |   |
| Pan Tilt_LimitSet | Set               | 8x 01 06 07 00 0W 0Y 0Y 0Y 0Y 0Z 0Z 0Z 0Z FF | <p><b>PW</b>: 1: UpRight 0:DownLeft</p> <p><b>YYYY</b>: Pan Limit Position(TBD)</p> <p><b>ZZZZ</b>: Tilt Limit Position(TBD)</p>  |
|                   | Clear             | 8x 01 06 07 01 0W 07 0F 0F 0F 07 0F 0F 0F FF |   |

# VISCA Protocol (CONTD)

## Part 3: Inquiry Command

| Command Type          | Command        | Return               | Note                           |
|-----------------------|----------------|----------------------|--------------------------------|
| CAM_PowerInq          | 8x 09 04 00 FF | y0 50 02 FF          | 0n                             |
|                       |                | y0 50 03 FF          | Off (Standby)                  |
| CAM_ZoomPosInq        | 8x 09 04 47 FF | y0 50 0p 0q 0r 0s FF | pqrs: Zoom Position            |
| CAM_FocusModelInq     | 8x 09 04 38 FF | y0 50 02 FF          | Auto Focus                     |
|                       |                | y0 50 03 FF          | Manual Focus                   |
| CAM_FocusPosInq       | 8x 09 04 48 FF | y0 50 0p 0q 0r 0s FF | pqrs: Focus Position           |
| CAM_WBModelInq        | 8x 09 04 35 FF | y0 50 00 FF          | Auto                           |
|                       |                | y0 50 01 FF          | Indoor Mode                    |
|                       |                | y0 50 02 FF          | Outdoor Mode                   |
|                       |                | y0 50 03 FF          | OnePush Mode                   |
|                       |                | y0 50 04 FF          | ATW                            |
|                       |                | y0 50 05 FF          | Manual                         |
| CAM_RGainInq          | 8x 09 04 43 FF | y0 50 00 00 0p 0q FF | pq: R Grain                    |
| CAM_BGainInq          | 8x 09 04 44 FF | y0 50 00 00 0p 0q FF | pq: B Grain                    |
| CAM_AEModelInq        | 8x 09 04 39 FF | y0 50 00 FF          | Full Auto                      |
|                       |                | y0 50 03 FF          | Manual                         |
|                       |                | y0 50 0A FF          | Shutter Priority               |
|                       |                | y0 50 0B FF          | Iris Priority                  |
|                       |                | y0 50 0D FF          | Bright                         |
| CAM_ShutterPosInq     | 8x 09 04 4A FF | y0 50 00 00 0p 0q FF | pq: Shutter Position           |
| CAM_IrisPosInq        | 8x 09 04 4B FF | y0 50 00 00 0p 0q FF | pq: Iris Position              |
| CAM_GainPosInq        | 8x 09 04 4C FF | y0 50 00 00 0p 0q FF | pq: Gain Position              |
| CAM_BrightPosInq      | 8x 09 04 4D FF | y0 50 00 00 0p 0q FF | pq: Bright Position            |
| CAM_ImageBrightPosInq | 8x 09 04 A4 FF | y0 50 00 00 0p 0q FF | pq: ImageBright Position       |
| CAM_SaturationInq     | 8x 09 04 A1 FF | y0 50 00 00 0p 0q FF | pq: Saturation level 0x00~0x0f |
| CAM_DefogInq          | 8x 09 04 A3 FF | y0 50 0p FF          | p: Defog level 0x00~0x0f       |
| CAM_ContrastInq       | 8x 09 04 A2 FF | y0 50 00 00 0p 0q FF | pq: Contrast level 0x00~0x0f   |
| CAM_WDRModelInq       | 8x 09 04 3D FF | y0 50 02 FF          | 0n                             |
|                       |                | y0 50 03 FF          | Off                            |
| CAM_WDRPosInq         | 8x 09 04 2D FF | 8x 01 04 02 03 FF    | pq: WDR LEVEL Position 1~6     |



# VISCA Protocol (CONTD)

| Command Type                | Command           | Return                           | Note                                    |                    |
|-----------------------------|-------------------|----------------------------------|---|--------------------|
| CAM_ApertureInq             | 8x 09 04 42 FF    | y0 50 00 00 0p 0q FF             | p: Aperture Gain                        |                    |
| CAM_FlickerInq              | 8x 09 04 AA FF    | y0 50 0p FF                      | p: Flick mode 0:off 1:50Hz 2:60Hz       |                    |
| CAM_2DNRInq                 | 8x 09 04 A5 FF    | y0 50 0p FF                      | p: 2DNR: 0=OFF 1= AUTO 2                |                    |
| CAM_3DNRInq                 | 8x 09 04 53 FF    | y0 50 0p FF                      | p: 3DNR: 0=OFF 1= AUTO 2-5=Manual Level |                    |
| CAM_GammaInq                | 8x 09 04 5B FF    | y0 50 0p FF                      | p: Gamma Position                       |                    |
| CAM_MemoryInq               | 8x 09 04 3F FF    | y0 50 pp FF                      | pp: Memory number last operated         |                    |
| SYS_MenuModelInq            | 8x 09 06 06 FF    | y0 50 02 FF                      | 0n                                      |                    |
|                             |                   | y0 50 03 FF                      | Off                                     |                    |
| CAM_LR_Reverse<br>Inq       | 8x 09 04 61 FF    | y0 50 02 FF                      | 0n                                      |                    |
|                             |                   | y0 50 03 FF                      | Off                                     |                    |
| CAM_PictureFlipInq          | 8x 09 04 66 FF    | y0 50 02 FF                      | 0n                                      |                    |
|                             |                   | y0 50 03 FF                      | Off                                     |                    |
| CAM_IDInq                   | 8x 09 04 22 FF    | y0 50 0p 0q 0r 0s FF             | pqrs: Camera ID                         |                    |
| CAM_DHCPInq                 | 8x 09 04 AE FF    | y0 50 pp FF                      |   |                    |
| CAM_IPInq                   | 8x 09 04 AB FF    | y0 50 0p 0p 0q 0q 0r 0r 0s 0s FF |   |                    |
| CAM_MASKInq                 | 8x 09 04 AC FF    | y0 50 0p 0p 0q 0q 0r 0r 0s 0s FF |   |                    |
| CAM_GATEWAYInq              | 8x 09 04 AD FF    | y0 50 0p 0p 0q 0q 0r 0r 0s 0s FF |   |                    |
| CAM_FlareModelInq           | 8x 09 04 B6 FF    | y0 50 pp FF                      |   |                    |
| CAM_FlareBright<br>ModelInq | 8x 09 04 B7 FF    | y0 50 pp FF                      |   |                    |
| CAM_FlareRed                | 8x 09 04 B8 FF    | y0 50 pp FF                      |   |                    |
| CAM_FlareGreen              | 8x 09 04 B9 FF    | y0 50 pp FF                      |   |                    |
| CAM_FlareBlue               | 8x 09 04 BA FF    | y0 50 pp FF                      |   |                    |
| CAM_VersionInq              | 8x 09 00 02 FF    | y0 50 ab cd mn pq rs tu vw FF    |   |                    |
| VideoSystemInq<br>(AIDA)    | 8x 09 06 23 FF    | y0 50 pp FF                      |   | pp: Video position |
| VideoSystemInq<br>(Sony)    | 8x 09 04 24 72 FF | y0 50 0p 0p FF                   |   | pp: Video position |
| IR_Transfer                 | 8x 09 06 1A FF    | y0 50 02 FF                      |   | 0n                 |
|                             |                   | y0 50 03 FF                      | Off                                     |                    |
| TallyInq                    | 8x 09 7E 01 0A FF | y0 50 0p FF                      | p: tally state                          |                    |
| IR_Receive                  | 8x 09 06 08 FF    | y0 50 02 FF                      | 0n                                      |                    |
|                             |                   | y0 50 03 FF                      | Off                                     |                    |
| IR_ReceiveReturn            |                   | y0 07 7D 01 04 00 FF             | Power ON/OFF                            |                    |

# VISCA Protocol (CONTD)

| Command Type             | Command           | Return                           | Note   |
|--------------------------|-------------------|----------------------------------|--|
| IR_ReceiveReturn         |                   | y0 07 7D 01 04 00 FF             | Zoom tele/wide   |
|                          |                   | y0 07 7D 01 04 07 FF             | AF On/Off  |
|                          |                   | y0 07 7D 01 04 33 FF             | CAM_Backlight  |
|                          |                   | y0 07 7D 01 04 3F FF             | CAM_Memory   |
|                          |                   | y0 07 7D 01 06 01 FF             | Pan_tiltDrive  |
| Pan-tiltMaxSpeed Inq     | 8x 09 06 11 FF    | y0 50 ww zz FF                   | ww: PanMaxSpeed zz: Tilt Max Speed   |
| Pan-tiltPosInq           | 8x 09 06 12 FF    | y0 50 0w 0w 0w 0z 0z 0z 0z FF    | wwwww: PanPosition zzzz: Tilt Position   |
| Mainstream ResolutionInq | 8x 09 04 C2 00 FF | y0 50 0p 0q 0r 0s 0m 0n 0x 0y FF | pqrs : Column(x size) mnx: Line (y size)<br>only supports: 1920x1080                 |
| MainstreamRate Inq       | 8x 09 04 C2 01 FF | y0 50 0p 0q 0r 0s 0m 0n 0x 0y FF | pqrsmnxy: bitrate (0~15360)  |
| Substream ResolutionInq  | 8x 09 04 C3 00 FF | y0 50 0p 0q 0r 0s 0m 0n 0x 0y FF | pqrs : Column(x size) mnx: Line (y size)<br>only supports: 1280x720/1024x576/640x360 |
| SubstreamRateInq         | 8x 09 04 C3 01 FF | y0 50 0p 0q 0r 0s 0m 0n 0x 0y FF | pqrsmnxy: bitrate (0~15360)  |

Note: [x] refers to camera address; [y] = [x +8]

## VISCA Pan Tilt Absolute Position Value

| Pan Angle | VISCA Value | Tilt Angle | VISCA Value |
|-----------|-------------|------------|-------------|
| -170      | 0xF670      | -30        | 0xFF50      |
| -135      | 0xF888      | 0          | 0x0000      |
| -90       | 0xFAF0      | 30         | 0x01B0      |
| -45       | 0xF078      | 60         | 0x0360      |
| 0         | 0x0000      | 90         | 0x0510      |
| 45        | 0x0288      |            |             |
| 90        | 0x0510      |            |             |
| 135       | 0x0798      |            |             |
| 170       | 0x0990      |            |             |

## VISCA Pan Tilt Speed Value

| Pan Degree/Second |     |     |     |
|-------------------|-----|-----|-----|
| 0                 | 0.3 | 0.3 | .03 |
| 1                 | 1   | 1   | 1   |
| 2                 | 1.5 | 1.5 | 1.5 |
| 3                 | 2.2 | 2.2 | 2.2 |
| 4                 | 2.4 | 2.4 | 3.6 |
| 5                 | 2.6 | 2.6 | 4.7 |
| 6                 | 2.8 | 2.8 | 6   |
| 7                 | 3.0 | 3.0 | 8   |
| 8                 | 3.2 | 3.2 | 10  |
| 9                 | 3.4 | 3.4 | 12  |
| 10                | 3.8 | 3.8 | 15  |
| 11                | 4.5 | 4.5 | 18  |
| 12                | 6   | 6   | 23  |

| Pan Degree/Second |     |    |    |
|-------------------|-----|----|----|
| 13                | 9   | 13 | 30 |
| 14                | 15  | 14 | 39 |
| 15                | 19  | 15 | 48 |
| 16                | 25  | 16 | 59 |
| 17                | 32  | 17 | 69 |
| 18                | 38  | 18 | 80 |
| 19                | 45  |    |    |
| 20                | 58  |    |    |
| 21                | 75  |    |    |
| 22                | 88  |    |    |
| 23                | 105 |    |    |
| 24                | 120 |    |    |

# UVC Control

The PTZ-X12-IP supports UVC interface.

|                                      |  |
|--------------------------------------|--|
| PU_BRIGHTNESS_CONTROL                | 81 01 04 4d 00 00 0p 0q FF             |
| PU_CONTRAST_CONTROL                  | 81 01 04 A2 00 00 0p 0q FF             |
| PU_SATURATION_CONTROL                | 81 01 04 A1 00 00 0p 0q FF             |
| PU_SHARPNESS_CONTROL                 | 8x 01 04 42 00 00 0p 0q FF             |
| PU_GAMMA_CONTROL                     | 8x 01 04 5B 0p FF                      |
| PU_WHITE_BALANCE_TEMPERATURE_CONTROL | 8x 01 04 35 0X FF                      |
| PU_BLACKLIGHT_COMPENSATION_CONTROL   | 81 01 04 33 02/03 FF                   |
| PU_POWER_LINE_FREQUENCY_CONTROL      | 8x 01 04 AA 00/01/02 FF                |
| CT_ZOOM_ABSOLUTE_CONTROL             | 8x 01 04 47 0p 0q 0r 0s FF             |
| CT_PANTILT_ABSOLUTE_CONTROL          | 8x 01 06 02 VV WWW 0Y 0Y 0Y 0Z 0Z 0Z F |
| CT_PANTILT_RELATIVE_CONTROL          | 8x 01 06 01 pp qq rr ss FF             |
| CT_ZOOM_RELATIVE_CONTROL             | 8x 01 04 07 pp FF                      |

# Warranty

AIDA Imaging warrants its cameras and items to be free from defects under normal use. Please refer to our website for more information at: [aidaimaging.com/support](http://aidaimaging.com/support)

# Support

If you would like additional support or explanation of anything on this manual, please feel free to go to our FAQ page on our website at [aidaimaging.com/support](http://aidaimaging.com/support). If you are in need of additional help, or have any general questions, please feel free to contact us in these various ways:

Telephone: 909.333.7421

Email: [Support@aidaimaging.com](mailto:Support@aidaimaging.com)

Website: [aidaimaging.com/support](http://aidaimaging.com/support)

We are open yearly, Mon-Fri 8A.M. to 5P.M. PST, excluding major holidays and events.

Also, keep up to date with firmwares and new releases from AIDA Imaging by signing up for our newsletter, found at the bottom of our website.



**AIDA**  
IMAGING