



Complete Manual for

RoboSHOT 20 UHD and RoboSHOT 40 UHD

Professional PTZ Cameras

Document 411-0028-30 Rev. C
January 2019

Contents

Overview	1
What's in this Guide	1
Camera Features	1
Unpacking the Camera	2
A Quick Look at the Camera	4
Front of the Camera	4
RoboSHOT 20 UHD: Back of the Camera	5
RoboSHOT 40 UHD: Back of the Camera	6
Camera Switch Settings	7
Video Resolution Selector	7
Camera Behavior Settings for RoboSHOT 20 UHD	8
Installing the Camera	9
Don't Void Your Warranty!	9
Before You Start	9
Installing the Wall Mount	10
About Ceiling-Mounted Cameras	10
Cabling Notes	11
Basic Connection Diagrams	12
Options for Power and Other Connections	13
RS-232 Serial Communication Settings and Port Pin-outs	14
Speed and Encoding	14
Connector Pin-Out	14
Installing the Camera	15
Powering Up the Camera	16
Status Light	16
Using the IR Remote	17
IR Remote Cheat Sheet	17
IR Remote Details	18
Storing a Preset Using the Remote	18
Clearing a Preset Using the Remote	18
Web Interface	19
Getting the Camera's IP Address	19
Accessing the Web Interface	19
Browser Support	19
User Access	20
Administrative Access	21
Compact Menu View	21
Web Interface Cheat Sheet	22
System Administration	23

For Non-DHCP Environments: Configuring the Device with a Static IP Address for Initial Installation	23
Changing the Camera's Hostname	25
Optional For DHCP Environments: Changing from a DHCP Address to a Static IP Address ..	26
Specifying Time Zone and NTP Server	27
Managing Access and Passwords	28
Disabling Telnet Access	28
Enabling or Requiring HTTPS	29
Adding Room Information to the Camera's Web Interface	30
Saving (Exporting) or Restoring (Importing) a Camera Configuration	31
Installing a Camera Firmware Update	32
Rebooting the Camera	33
Contacting Vaddio Technical Support	34
Accessing the Diagnostic Logs	34
Configuring Camera Behavior	35
Configuring IP Streaming	35
Setting up RTSP Streaming in Easy Mode	36
Setting up RTSP Streaming in Custom Mode	37
RTSP Streaming Protocol and URL	38
Configuring RTMP Streaming	39
Advanced: Changing MTU	41
Stopping the IP Stream	41
Adjusting the Focus	42
Defining Video Mute Behavior for the RoboSHOT 40 UHD Camera	42
Lighting and Color Adjustments: Setting up Custom CCU Scenes	43
Lighting Adjustments	44
Fine-Tuning Image Quality and Color	45
Saving Color and Lighting Settings	45
Lighting and Image Quality Cheat Sheet	46
Color Adjustment Cheat Sheet	47
Setting the Custom Home Position and Other Preset Shots	48
Renaming Presets and Custom CCU Scenes	48
Setting the Speed for Manual Movements	49
Setting the Direction for Camera Movements	49
Genlock Settings and Adjustments – RoboSHOT 40 UHD Only	50
Reading the Camera's Switches	51
Software Switch Settings – RoboSHOT 40 UHD Only	52
Software Switch Settings – Both Models	53
Operating the Camera from the Web Interface	54
Switching the Camera Off or On (Standby)	54
Stop or Resume Sending Video (Mute)	54

Moving the Camera	55
Zooming In or Out	55
Moving the Camera to a Preset Position	55
Adjusting the Color and Lighting	55
Telnet Command Reference	56
camera home	57
camera pan	57
camera tilt	58
camera zoom	59
camera focus	60
camera preset	61
camera ccu get	62
camera ccu set	63
camera ccu scene	64
camera led	64
camera standby	65
video mute	65
streaming settings get	66
streaming ip enable	67
network ping	67
network settings get	68
system reboot	68
system factory-reset	69
history	70
version	70
help	71
exit	71
RS-232 Serial Command Reference	72
Camera Movement, Zoom, and Focus Commands	72
Movement, Zoom, and Focus Inquiry Commands	74
Color and Light Management Commands	75
Shutter Speed Values	77
Iris Position Values	78
Iris Gain Values	79
Iris Gain Limit Values	79
Color and Light Management Inquiry Commands	80
Other Commands	80
Other Inquiry Commands	81
Specifications	82
Troubleshooting and Care	83
Check the Status Light First	83

Check the Cables Next	83
Power/Responsiveness Issues	83
Video and Streaming Issues	84
Camera Control and Other Issues	85
Restoring Factory Settings from the Web Interface	86
Restoring Factory Default Settings Via Hardware – RoboSHOT 20 UHD	86
Restoring Factory Default Settings Via Hardware – RoboSHOT 40 UHD	86
Operation, Storage, and Care	87
Compliance Statements and Declarations of Conformity	88
FCC Part 15 Compliance	88
ICES-003 Compliance	88
European Compliance	89
Warranty and Return Policy	90
Photo Credits	94
Index	95

Overview

This guide covers the RoboSHOT® 20 UHD and RoboSHOT 40 UHD professional PTZ cameras:

- RoboSHOT 20 UHD, North America – 999-9950-000 (silver/black); 999-9950-000W (white)
- RoboSHOT 20 UHD, Europe/UK – 999-9950-001 (silver/black); 999-9950-001W (white)
- RoboSHOT 20 UHD, Australia/New Zealand – 999-9950-009 (silver/black); 999-9950-009W (white)
- RoboSHOT 40 UHD, North America – 999-9952-000 (black); 999-9952-000W (white)
- RoboSHOT 40 UHD, Europe/UK – 999-9952-001 (black); 999-9952-001W (white)
- RoboSHOT 40 UHD, Australia/New Zealand – 999-9952-009 (black); 999-9952-009W (white)



What's in this Guide

This guide covers:

- Unpacking
- Physical features
- Switch settings
- Installation
- Controlling the camera using the IR remote
- Web interface: system administration and performance/behavior configuration
- Telnet and RS-232 API references
- Specifications
- Troubleshooting
- Warranty and compliance/conformity information

For your convenience, the information you need to install this product is also available in the smaller, stand-alone **Installation Guide for RoboSHOT 20 UHD and RoboSHOT 40 UHD Professional PTZ Cameras**, which covers unpacking, physical features, switch settings, installation, and initial power-up.

Download manuals, dimensional drawings, and other information from www.vaddio.com/support.

Camera Features

- Back-illuminated, ultra high definition Exmor R™ sensor delivers native UHD (3840 x 2160) video
- Imaging and performance comparable to 3-chip cameras
- Professional performance and flexibility, with simultaneous 3G-SDI, HDMI, and H.264 IP streaming
- RoboSHOT 40 UHD is Vaddio's first camera with genlock
- View the RTSP stream from the camera using any standards-based media viewer
- RoboSHOT 20 UHD: 12x optical zoom; 20x combined optical and digital zoom; horizontal field of view 74° (wide) to 4.8° (tele) at 20x
- RoboSHOT 40 UHD: 20x optical zoom; 40x combined optical and digital zoom; horizontal field of view 70° (wide) to 4.1° (tele) at 20x
- Tri-Synchronous Motion™ simultaneous 3-axis pan/tilt/zoom movement between presets
- Smooth, silent direct-drive motors – ultra-accurate positioning, from 120° per second down to 0.35° per second
- Web interface for remote administration and operation, integration-ready Telnet or serial RS-232 control, presenter-friendly IR remote control

Unpacking the Camera

Make sure you received all the items you expected.



Caution

Always support the camera's base when picking it up. Lifting the camera by its head or mounting arm will damage it.

RoboSHOT 20 UHD, silver/black, North America – 999-9950-000

RoboSHOT 20 UHD, white, North America – 999-9950-000W

RoboSHOT 20 UHD, silver/black, Europe and UK – 999-9950-001

RoboSHOT 20 UHD, white, Europe and UK – 999-9950-001W

RoboSHOT 20 UHD, silver/black, Australia and New Zealand – 999-9950-009

RoboSHOT 20 UHD, white, Australia and New Zealand – 999-9950-009W

- RoboSHOT 20 UHD camera, 998-9950-000
- 12 VDC, 3.0 A switching power supply with AC cord set(s)
- Thin Profile Wall Mount with mounting hardware, black (535-2000-240) or white (535-2000-240W), depending on camera color
- Vaddio IR Remote Commander (998-2100-000)
- EZCamera RS-232 Control Adapter (998-1001-232)
- Quick Start Guide



OR



RoboSHOT 40 UHD, black, North America – 999-9952-000

RoboSHOT 40 UHD, white, North America – 999-9952-000W

RoboSHOT 40 UHD, black, Europe and UK – 999-9952-001

RoboSHOT 40 UHD, white, Europe and UK – 999-9952-001W

RoboSHOT 40 UHD, black, Australia and New Zealand – 999-9952-009

RoboSHOT 40 UHD, white, Australia and New Zealand – 999-9952-009W

- RoboSHOT 40 UHD camera, 998-9950-000
- 12 VDC, 3.0 A switching power supply with AC cord set(s)
- Thin Profile Wall Mount with mounting hardware, black or white depending on camera color
- Vaddio IR Remote Commander (998-2100-000)
- EZCamera RS-232 Control Adapter (998-1001-232)
- Quick Start Guide



OR



A Quick Look at the Camera

This section covers the physical features of the camera.

Front of the Camera



- **Camera and Zoom Lens, RoboSHOT 20 UHD (image on the left):** 20x zoom range; 4.8° field of view at 20x. Horizontal field of view up to 74°. Optical zoom to 12x, combined optical and digital zoom from 12x to 20x.
- **Camera and Zoom Lens, RoboSHOT 40 UHD (image on the right):** 40x zoom range; 4.1° field of view at 40x. Horizontal field of view up to 70°. Optical zoom to 20x, combined optical and digital zoom from 20x to 40x at 1080p, or 20x to 30x at 2160p.
- **Dual-arm mount** provides superior stability.
- **IR Sensors:** Sensors in the front of the camera base receive signals from the remote. Make sure there's nothing directly in front of the camera base, and point the remote at the camera.
- **Status indicator:** The multicolored LED indicates the camera's current state.

RoboSHOT 20 UHD: Back of the Camera



From left to right:

- **12 VDC, 3.0 A power connector** – For local power. Not used when connecting the camera to a OneLINK device or a PoE++ power injector. Use only the 12 VDC, 3A power supply.
- **OneLINK HDBaseT connector** – Network connectivity for streaming and control; also for power if a PoE++ injector or OneLINK device is used.
- **HDMI connector** – HDMI video output.
- **HD-SDI connector** – HD-SDI video output.
- **RS-232 port** – Allows an external device to control the camera using a modified VISCA protocol. See [RS-232 Serial Communication Settings and Port Pin-outs](#).
- **HD video select switch** – Sets the video output resolution.
- **Camera Settings DIP switches** – Sets camera behaviors such as IR remote frequency, image flip, and RS-232 baud rate. See [Camera Settings](#) for more information.

RoboSHOT 40 UHD: Back of the Camera



From left to right:

- **12 VDC, 3.0 A power connector** – For local power. Not used when connecting the camera to a OneLINK device or a PoE++ power injector. Use only the 12 VDC, 3A power supply.
- **OneLINK HDBaseT connector** – Network connectivity for streaming and control; also for power if a PoE++ injector or OneLINK device is used.
- **HDMI connector** – HDMI video output.
- **SDI connector** – 3G-SDI video output.
- **Sync connector** – For genlock signal.
- **RS-232 port** – Allows an external device to control the camera using a modified VISCA protocol. See [RS-232 Serial Communication Settings and Port Pin-outs](#).
- **Camera Settings rotary switch** – Sets the video output resolution.

Note

A label on the bottom of the camera lists the physical switch settings.

Camera Switch Settings

Both models use a rotary switch to set the video resolution. The RoboSHOT 20 UHD camera uses DIP switches to set some basic camera behaviors; the RoboSHOT 40 UHD camera uses "soft DIP switches" in the web interface to set these behaviors.

A label on the bottom of the camera provides a quick reference for setting the switch or switches on the back. After the camera is installed, you can read all switches from the camera's web interface.

Set the switch or switches on the back of the camera before mounting the camera.

Video Resolution Selector

Set the desired output resolution for the camera with the rotary switch.

Notes

The maximum resolution for the HD-SDI output and the IP stream is 1080p.

On the RoboSHOT 20 UHD, when the video output is set to 1080p/29.97 or 1080p/25 (rotary switch positions 4 and 5), the HDMI output is at double the specified frame rate, with each frame doubled. Other outputs deliver the specified frame rate. This is a limitation of the camera hardware.

On the RoboSHOT 40 UHD, zoom is limited to 30x at 2160p.

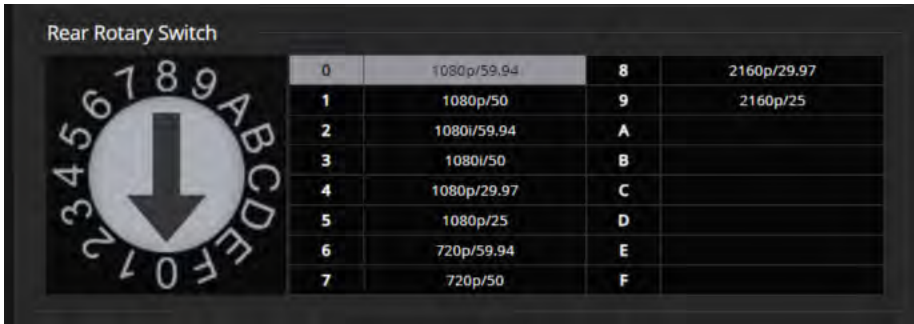

Camera Behavior Settings for RoboSHOT 20 UHD

DIP switches on the back of the RoboSHOT 20 UHD set its basic behaviors.

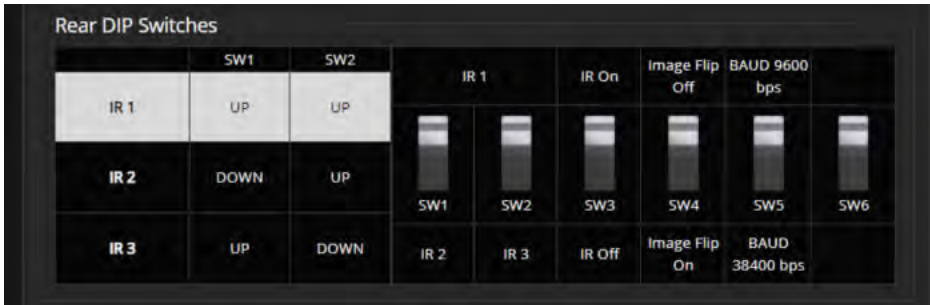

Note

When the camera is not inverted, DIP switches are in their default positions when they are up.

IR1, IR2, IR3 (Frequency Selection): If there are multiple cameras in the room, use **switches 1 and 2** to configure each with a different IR frequency to allow the IR Remote Commander to control them independently. Then use the Camera Select buttons at the top of the remote to select the camera you want to control.

- SW1 and SW2 up: IR frequency 1
- SW1 down, SW2 up: IR frequency 2
- SW1 up, SW2 down: IR frequency 3

IR: Leave **switch 3** UP if the IR remote will be used.

Image Flip: If mounting the camera upside-down, set **switch 4** DOWN: IMAGE FLIP ON.

Baud Rate: Set **switch 5** to the baud rate of the device connected to the RS-232 port. The default is 9600 bps. The 38400 baud setting is optional if the connected control device supports it.

Switch 6 is not currently used.

Note

On the RoboSHOT 40 UHD, these settings are available using the corresponding soft DIP switches on the System page of the web interface. See [Software Switch Settings – RoboSHOT 40 UHD Only](#).

Installing the Camera

This section covers:

- Selecting the location for the camera
- Installing the mount
- Connection diagrams
- RS-232 cable pin-out and communication settings
- Connecting and mounting the camera

Don't Void Your Warranty!



Caution

Always support the camera's base when picking it up. Lifting the camera by its head or mounting arm will damage it.

Caution

This product is for indoor use. Use an appropriate protective enclosure if installing it outdoors or in a humid environment.

Do not install or operate this product if it has been dropped, damaged, or exposed to liquids. If any of these things happen, return it to Vaddio for safety and functional testing.

Caution

If using a DC power supply with this product, use the power supply included with it or recommended for use with it. Always check the output voltage listed on the power supply label, as power supplies for different products may look nearly identical. Using the wrong power supply will void the warranty, possibly causing unsafe operating conditions and damage to the product.

Before You Start

Things to keep in mind when deciding where to install the camera:

- Consider camera viewing angles, lighting conditions, line-of-sight obstructions, and in-wall obstructions.
- If the IR Remote Commander will be used, ensure that nothing blocks the IR lens in the camera's base.
- Ensure that the camera body can move freely and point away from the ceiling and lights.

Prepare for a successful installation:

- Be sure you can identify all cables correctly.
- Check Cat-5 cables for continuity.
- Ensure that the DIP switches (if present) and the video resolution switch are set appropriately. See [Camera Switch Settings](#).

Installing the Wall Mount

The camera is shipped with a Thin Profile Wall Mount. Other mounting options are available as well. Contact us if you don't have the camera mount you need.

If you are installing a OneLINK camera extension system with the camera, attach the EZIM (the smaller unit) to the camera mount and route the camera cables through the opening before you install the mount. Refer to the Quick-Start Guide supplied with the OneLINK extension, or to the OneLINK manual available at support.vaddio.com/resources.

You can install the camera wall mount to a 2-gang wall box or directly to the drywall.

- If you mount it to drywall, use the wall anchors provided with the wall mount.
- If you mount it to a wall box, use the cover plate screws supplied with the wall box.

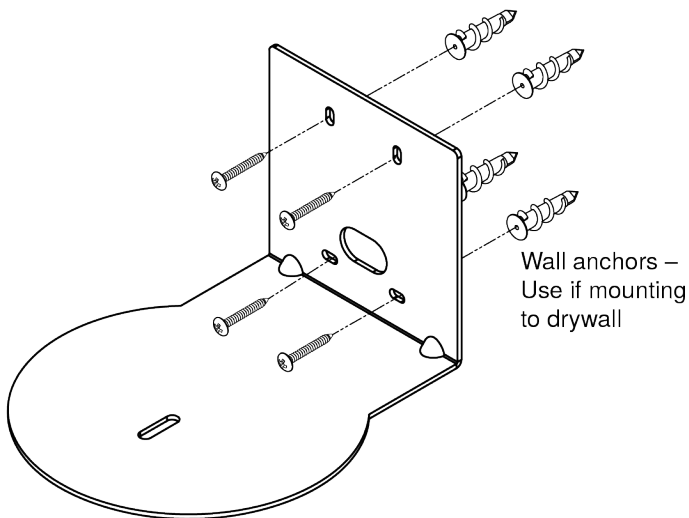

About Ceiling-Mounted Cameras

If you use an inverted mount, set the camera's Image Flip DIP switch ON for inverted operation. See [DIP Switches: Camera Behavior Settings](#) for more information.

Note

On the RoboSHOT 40 UHD, this setting is available using the corresponding soft DIP switch on the System page of the web interface. See [Software Switch Settings – RoboSHOT 40 UHD Only](#).

Cabling Notes

Caution

Do not use pass-through RJ-45 connectors. If they are crimped incorrectly, they can damage the connectors on the product, cause intermittent connections, and degrade signal quality. Physical damage to the connectors may void your warranty.



Intact – will make reliable contact with cable connector



Damaged – Bent contact fingers will NOT make reliable contact with cable connector

Use Cat-5e or better cable. We recommend using high-quality connectors and a high-quality crimping tool. We recommend shielded cabling if the cables will be coiled, run tightly with other cables, or placed close sources of electromagnetic interference such as power lines.

Caution

Check your cables. Connecting a cable to the wrong port or using the wrong pin-out can result in equipment damage and will void the warranty.



Pro Tip

To prevent tragic mishaps, label both ends of every cable.

Basic Connection Diagrams

Here is a simple set-up for the RoboSHOT 20 UHD camera.



Here is a simple set-up for the RoboSHOT 40 UHD camera, using genlock.



Options for Power and Other Connections

Use the provided 12 VDC power supply – As shown in the Basic Connections section, this set-up requires separate connections for power, network, control, and video output.

Use a PoE++ power injector – Connect to the network and to power through a PoE++ power injector. Video output and RS-232 control (if used) require separate connections. In most cases, you do not need to use the camera's 12 VDC power supply in this configuration.

Connect the camera to a OneLINK® device – A single Cat-5e (or better) cable to the OneLINK/HDBaseT connector provides power, control, network, and video connectivity. Network, video output, and RS-232 control are connected at the OneLINK receiver. Do not use the camera's 12 VDC power supply in this configuration.

This example shows basic connections for a RoboSHOT 20 UHD camera using a OneLINK HDMI extension. Connection details vary depending on the equipment and functionality to be used in your installation.



RS-232 Serial Communication Settings and Port Pin-outs

The RS-232 serial port (color-coded blue) near the center of the camera's back panel provides another means of controlling the camera.

Speed and Encoding

Specification	Value
Communication Speed	9600 or 38400 baud, selectable
Number of start bits	1
Number of stop bits	1
Number of data bits	8
Parity	None
Flow control	None

9600 baud is default. The 38400 baud setting is optional if the connected device supports it.

Connector Pin-Out

- Pin 1: Not used
- Pin 2: Not used
- Pin 3: Not used
- Pin 4: Not used
- Pin 5: Not used
- Pin 6: GND
- Pin 7: RXD (from TXD of control source)
- Pin 8: TXD (to RXD of control source)

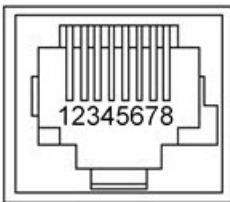

Caution

Check your cables. Connecting a cable to the wrong port or using the wrong pin-out can result in equipment damage and will void the warranty.

Installing the Camera

Be sure you have already set the camera's DIP switches (if present) and video resolution switch.

Caution

Check your cables. Connecting a cable to the wrong port or using the wrong pin-out can result in equipment damage and will void the warranty.

1. Route the cables to the camera location.
2. Route the cables through the mount, and install the mount on the wall or attach it to the wall box. Leave the screws loose enough to adjust the position of the mount.
3. Level the mount and tighten the mounting screws.
4. Connect the cables to the camera.

Caution:

If using local power rather than connecting to a OneLINK device or using PoE++, use the power supply shipped with the camera. Using a different power supply may create an unsafe operating condition or damage the camera, and will void the warranty.

5. Place the camera on the mount.

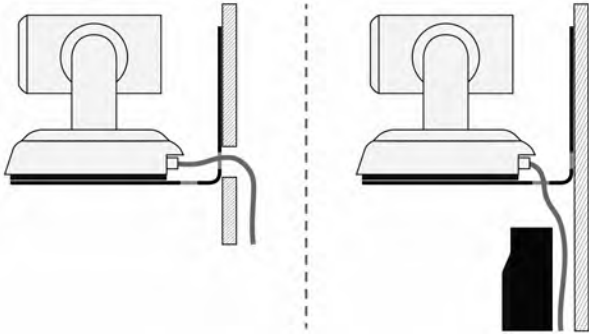

6. Attach the camera to the mount using the 1/4"-20 x .375 mounting screw supplied with the camera.

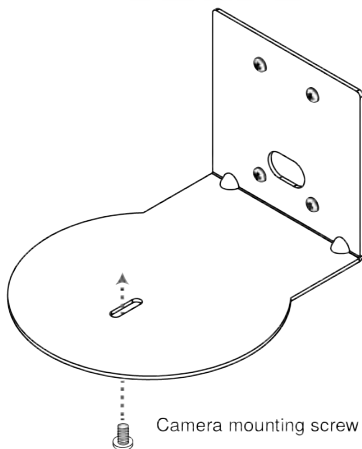

Images for illustration only; not to scale. Camera and mount details may differ.

Powering Up the Camera

Connect camera power.

The camera will run a self-test routine and move to its home position. This will take a few seconds.

When the camera is initialized and ready, video is available and the status light is blue. At this point, the camera is ready to accept control information.

Note

Wait until the camera finishes initializing before trying to operate or control it.

Status Light

The light in the camera's base indicates its current state.

- **Blue:** Normal operation (blinks once when the camera receives a command from the remote)
- **Red:** On-air tally (Pro A/V color scheme only)
- **Purple:** In standby mode or booting
- **Yellow:** Firmware update in progress

Caution

Do not remove power or reset the camera while the indicator is yellow, showing a firmware update in progress. Interrupting a firmware update can make the camera unusable.

Note

By default, the camera's status light is active during normal operation; however, it can be configured to remain off when the camera is powered up. The camera may be sending video even if the indicator light is off.

Using the IR Remote

The IR remote provides basic camera control for end users.

IR Remote Cheat Sheet

What do you need to do?	Button(s)
Power on or standby	Power (green button at top right)
Select the camera to control (if this remote controls more than one)	Camera Select buttons 1 through 3 (second row of buttons)
Discover the camera's IP address	Data Screen button (top left) – press and hold for 3 seconds.
Move the camera	Arrow buttons and Home button (dark red)
Move the camera to a preset position	Position Preset buttons 1 through 6 (bottom two rows)
Focus the camera	Auto Focus button (near arrow buttons) Manual Focus buttons Near and Far (below Zoom Speed buttons)
Control zoom speed	Zoom Speed buttons (light gray) - Slow T and W , Fast T and W for telephoto (zoom in) and wide-angle (zoom out) modes
Adjust for excess light behind the camera's subject	Back Light button (top center)

IR Remote Details

The Vaddio remote provides the following functions:

Power – Switch the selected camera on or off.

Power indicator – Lights momentarily when you press a button.

Back Light – Use or turn off Back Light Compensation.

Data Screen – Display the camera's IP address and MAC address. Press this button again to dismiss the display.

Camera Select – In multi-camera installations, selects the camera to be controlled. If your camera is a RoboSHOT 20 UHD, see [Camera Behavior Settings for RoboSHOT 20 UHD](#) for information on configuring the camera as camera 1, 2, or 3. If the camera is a RoboSHOT 40 UHD, see [Software Switch Settings](#).

Pan/Tilt (arrow button) controls and Home button – Control the camera's position.

Rev. Pan and Std. Pan – Control how the camera responds to the arrow buttons. Helpful for ceiling-mounted cameras and for presenters who are controlling the camera.

Pan/Tilt Reset – Not used.

Auto Focus – Switch the camera to Auto-Focus mode.

Zoom Speed – Select Slow or Fast movements for telephoto and wide-angle shots.

- T slow and T fast – Telephoto (zoom in)
- W slow and W fast – Wide-angle (zoom out)

Manual Focus – Switch the camera to Manual Focus mode.

Near (-) adjustment – Moves the focus nearer when in manual focus mode.

Far (+) adjustment – Moves the focus farther when in manual focus mode.

Preset – Save the camera's current position as one of the numbered presets.

Reset – Clear a saved preset.

Position Presets 1 through 6 – Move the camera to a predefined position, or specify the preset to save or clear.

The web interface offers greater control over camera movements to presets (such as setting the speed for Tri-Synchronous Motion), and provides additional presets.

Storing a Preset Using the Remote

Position the camera. Then hold down the Preset button and press one of the numbered preset buttons.

Clearing a Preset Using the Remote

Press and hold the Reset button while pressing the preset number you want to clear.



Web Interface

The camera's web interface allows control via a network connection, using a browser. Password-protected pages provide administrative access to tasks such as setting passwords, changing the IP address, viewing diagnostics, and installing firmware updates. The user login (or guest access, if it is enabled) provides access to camera controls similar to those available from the IR remote.

You will need to know the camera's IP address to use its web interface. If the network has a DHCP server, the camera will get its IP address, gateway and routing information automatically and you will be able to browse to it. If not, you will need to configure the camera to use a static IP address.

For cameras powered by a OneLINK HDMI or OneLINK Bridge: The OneLINK device has its own web interface. Refer to the appropriate OneLINK manual for information on its web interface.

Getting the Camera's IP Address

You will need to be able to view the camera's video output.

1. Press the Data Screen button on the remote. The display presents the camera's IP address and MAC address.
2. Press the Data Screen button again to dismiss the information.

If the address is 169.254.1.1, the camera is using its default IP address. This usually means one of these things:

- The network automatically assigns IP addresses, but the camera is not connected to the network.
- The network does not automatically assign IP addresses, and you need to configure the camera for the network. See [Configuring the Camera with a Static IP Address](#).

Accessing the Web Interface

Enter the IP address or hostname in your browser's address bar. You may need to enter `http://` or `https://` as a prefix to keep the browser from treating it as a search query.

(Example: `http://10.30.200.125`)

Browser Support

We have tested this product with these web browsers:

- Chrome®
- Microsoft® Internet Explorer®
- Safari®
- Firefox®

We test using the browser version available from the vendor at that time. Older versions of these browsers are likely to work, and other browsers may also work.

User Access

By default, the web interface opens to the Controls page, but the camera can be configured to require a user login. The default user password is **password**, but this can be changed. Check with the system administrator if the camera's web interface requires you to log in.

Only the Controls page is available with user-level access.

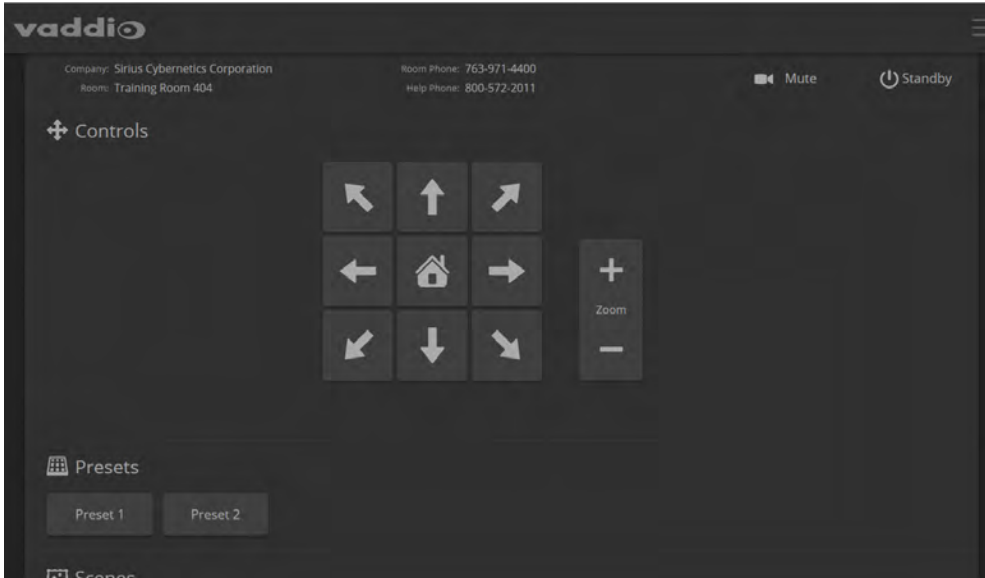

Your camera's Controls page will look somewhat different.

Administrative Access

If you are on the Controls screen, you're logged in at the user level, or guest access is enabled and you're not logged in at all.

Your camera's web interface will look somewhat different from this image.

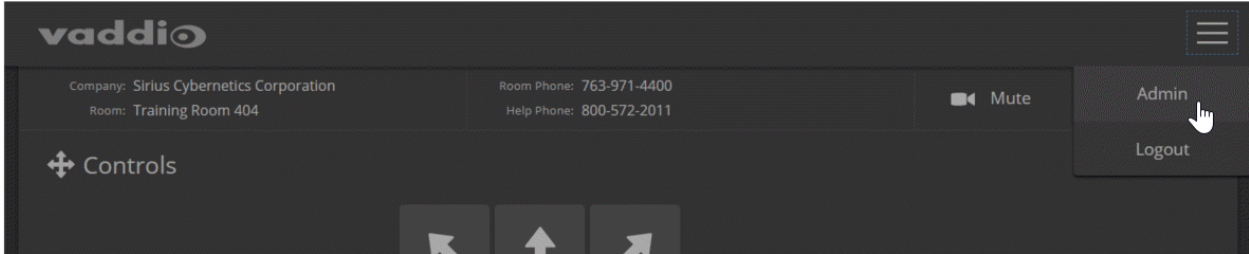

Open the menu to log on as Admin. The default admin password is **password**, but this can be changed.

Note

For best security, Vaddio strongly recommends changing the user and admin passwords from the default. Using the default passwords leaves the product vulnerable to tampering.

The admin account has access to system administration tasks and performance/behavior configuration tasks. System administration tasks are on the following pages, listed in the lower portion of the left navigation panel:

- Networking page – Configure date and time settings, hostname, and IP addressing.
- Security page – Set passwords, manage guest access, and enable/disable Telnet access.
- System page – View firmware version and switch settings, reboot, restore factory defaults, and update firmware.
- Room Labels page – Information to display on the web interface screens, including the conference room name and phone number and the in-house number for AV assistance.
- Help page – Tech support contact information and a link to the product information library on the Vaddio website.
- Diagnostics page – View or download the diagnostic log when troubleshooting issues.

Performance and behavior configuration tasks are on the following pages, listed in the upper portion of the left navigation panel:

- Camera page – Control the camera, make adjustments, create and manage presets and CCU scenes.
- Streaming page – Configure IP streaming.

Compact Menu View

By default, the navigation buttons in the camera's administrative interface display an icon and a text label. You can also select the compact view of the menu buttons along with the standard view. The button at the bottom of the menu toggles between the two views.

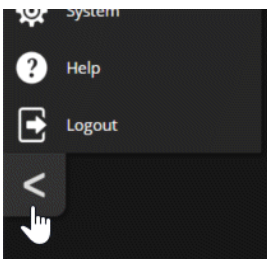

Web Interface Cheat Sheet

Where to find the camera controls you need right now.

What do you need?	Go to this screen
Camera operation <ul style="list-style-type: none"> ■ Stop sending video (video mute) ■ Enter or exit standby mode 	(any page)
Camera operation <ul style="list-style-type: none"> ■ Move or zoom the camera manually ■ Move to a camera preset (Presets section, if available) ■ Select the appropriate lighting adjustments (CCU Scenes section, if available) 	Controls (user or guest access) or Camera (admin access)
Camera behavior and adjustments <ul style="list-style-type: none"> ■ Set or clear presets ■ Set the speed for pan, tilt, or zoom motions ■ Focus the camera ■ Work with color and lighting adjustments (CCU scenes) ■ Set motors for inverted operation (Settings button reveals the control) 	Camera
Advanced camera settings <ul style="list-style-type: none"> ■ HDMI color space (YCbCr or sRGB; default is YCbCr) ■ 3G HD-SDI level (A or B; default is A) ■ Indicator light – select color scheme, enable/disable, set behavior in standby mode ■ Codec control mode 	System (DIP switches tab)
Read-outs of the camera's hardware switch settings	System (DIP switches tab)
Access management <ul style="list-style-type: none"> ■ Guest access ■ Account passwords ■ Idle session time-out ■ Telnet access enabled/disabled ■ Advanced security settings 	Security
IP streaming settings <ul style="list-style-type: none"> ■ Quality, resolution, and frame rate ■ RTSP streaming URL and path ■ RTMP service provider configuration 	Streaming
Network settings <ul style="list-style-type: none"> ■ Hostname ■ DHCP or static addressing ■ Static: IP address, subnet mask, gateway 	Networking
Time zone and NTP server (source for system time/date)	Networking
Information about the camera location Help desk phone number for end users	Room Labels
Vaddio Technical Support contact information	Help
Diagnostic logs	Diagnostics

System Administration

Administrative tasks are on these pages of the web interface:

- Networking – Ethernet configuration, time zone and NTP server
- Security – Passwords, guest access, other IT security-related settings
- Room Labels – Helpful information to display in the web interface
- System – Controls to reboot, reset to factory defaults, and run firmware updates, read the rear panel switches, and access the soft DIP switches
- Help – Contact information for Vaddio Technical Support and a link to the documentation for this product
- Diagnostics – Logs to help Vaddio Technical Support troubleshoot issues

Note

Vaddio's RoboSHOT series cameras all have very similar web interfaces. Some of the screen shots in this manual may be from other models in the RoboSHOT series.

Some of the screen shots in this manual are from the RoboSHOT 20 UHD web interface; some are from the RoboSHOT 40 UHD web interface. Any differences will be noted.

For Non-DHCP Environments: Configuring the Device with a Static IP Address for Initial Installation

NETWORKING PAGE

Caution

Consult your IT department before editing network settings. Errors in network configuration can make the camera inaccessible from the network. Do not change DHCP/Static addressing, IP address, subnet mask, or gateway unless you are very familiar with the characteristics and configuration of the network where you install the camera.

By default, the camera is set to DHCP and you do not need to configure it with a static IP address. However, if no DHCP server is available to automatically assign an address, the camera will use the default IP address of 169.254.1.1. If this is the case, you may need to follow this procedure.

If you install more than one camera on a network that does not automatically assign IP addresses (a non-DHCP network), follow this procedure to prevent IP address conflicts.

Note

If the camera is currently at an IP address other than 169.254.1.1, skip this section unless you are instructed to configure the camera with a static IP address.

To access the camera's Networking page during installation (skip this procedure if the camera has already been in service on this network):

1. Connect the camera according to the connection diagram, but *do not connect the camera to the network*.
2. Connect the network port on the camera to the network port on a computer. Depending on the computer, you may need a crossover cable.
3. On the computer, open a browser and access the camera's web interface at **http://169.254.1.1**.
4. Log in as admin. The default password is **password**.

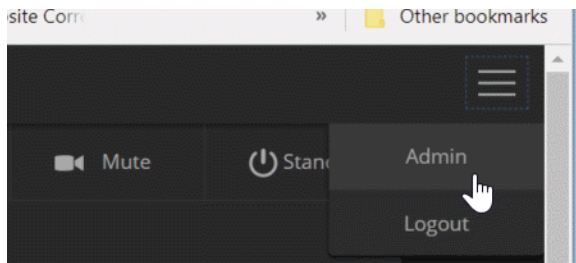

5. Navigate to the Networking page.

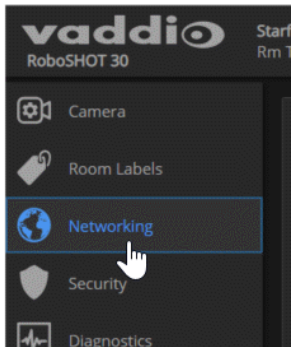

To configure the camera with a static IP address:

1. Work with your IT department to determine the correct IP address, subnet mask, and gateway to assign.
2. On the Networking page, set IP Address to Static.
3. Enter the IP address, subnet mask, and gateway as directed by the IT staffer; then save your work.

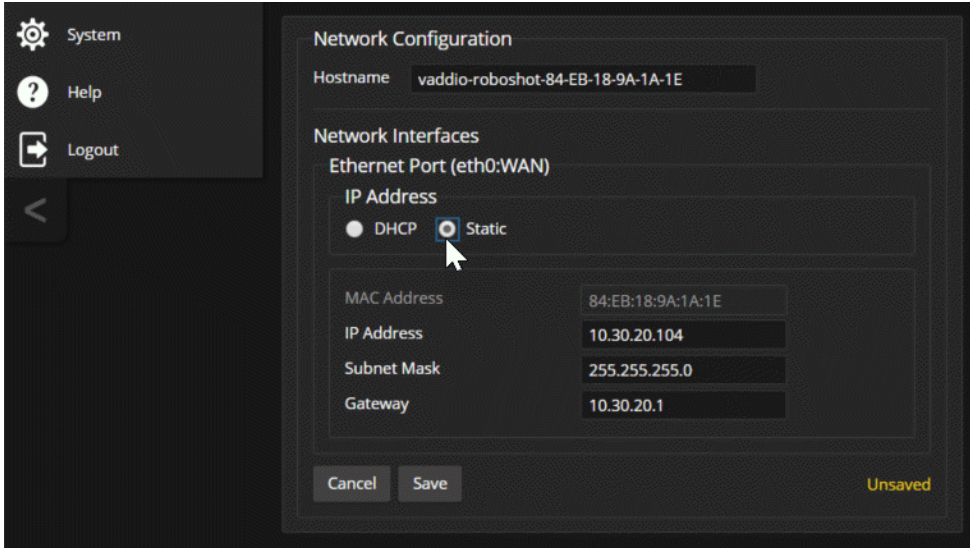

The camera is now ready to be connected to the network.

Changing the Camera's Hostname

NETWORKING PAGE

If your network supports hostname resolution, you may find it convenient to change the camera's hostname to something easy to remember, such as **camera-center-boardroom**.

Work with your IT department to ensure that the new hostname conforms to the organization's naming conventions.

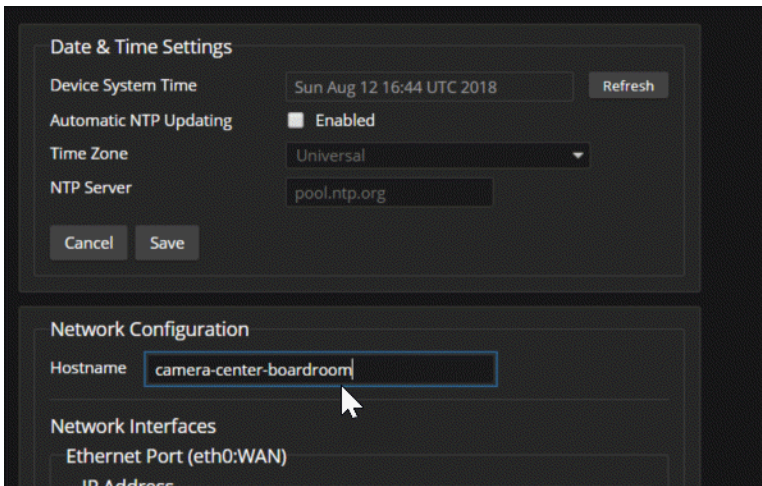

Optional For DHCP Environments: Changing from a DHCP Address to a Static IP Address

NETWORKING PAGE

In a network that assigns IP addresses automatically, the camera's IP address may change from time to time. To keep this from happening, set the IP address to Static. *Do not change the IP address, subnet mask, or gateway.*

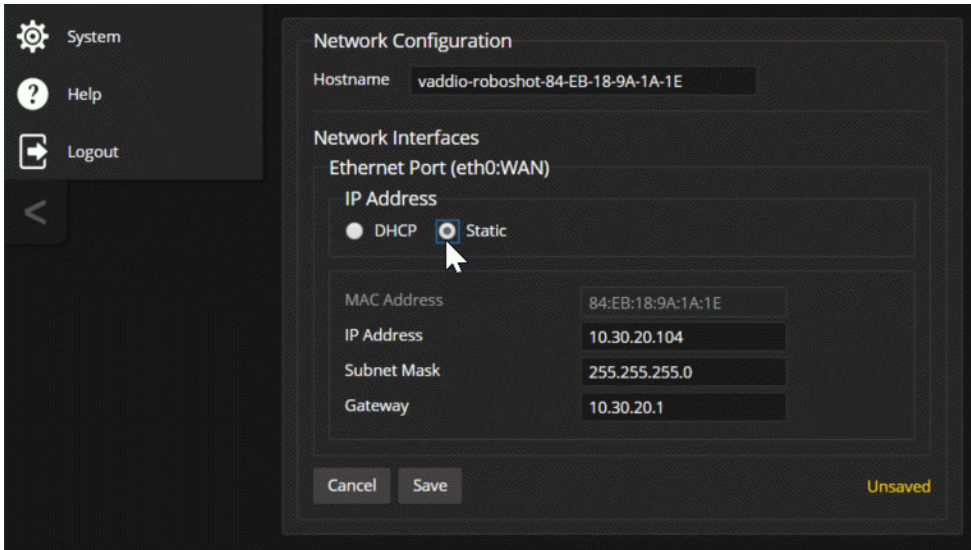

Specifying Time Zone and NTP Server

NETWORKING PAGE

Using automatic NTP updating ensures that the timestamps in the camera's diagnostic log are accurate. Specifying your time zone may make it easier to match logged events with other actions and external events.

1. To make the time zone and NTP server editable, enable Automatic NTP Updating.
2. Select the desired time zone from the list.
3. If desired, specify the NTP server to use. Otherwise, use the default.

You may need to refresh the system time display.

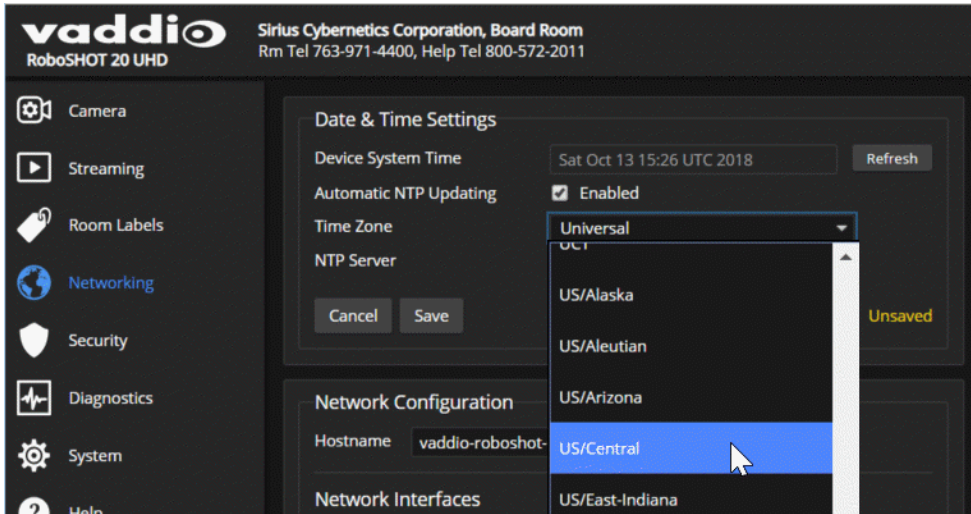

Managing Access and Passwords

SECURITY PAGE

Set the camera according to your organization's security policies:

- Allow or deny access to the Camera screen without logging on (Allow Guest Access)
- Set whether inactive sessions log off automatically or not (Automatically Expire Idle Sessions)
- Change the password for the `admin` account
- Change the password for the `user` account
- Allow or disable access via Telnet (by default, access via Telnet is enabled)
- Require HTTPS for web access (by default, HTTP is also permitted)
- Allow or deny device discovery (allowed by default)

Some of these capabilities may be absent if the camera has not been updated with the latest firmware.

Note

Consult your network security specialist before changing any of these settings.

Note

For best security, Vaddio strongly recommends changing the user and admin passwords from the default. Using the default passwords leaves the product vulnerable to tampering.

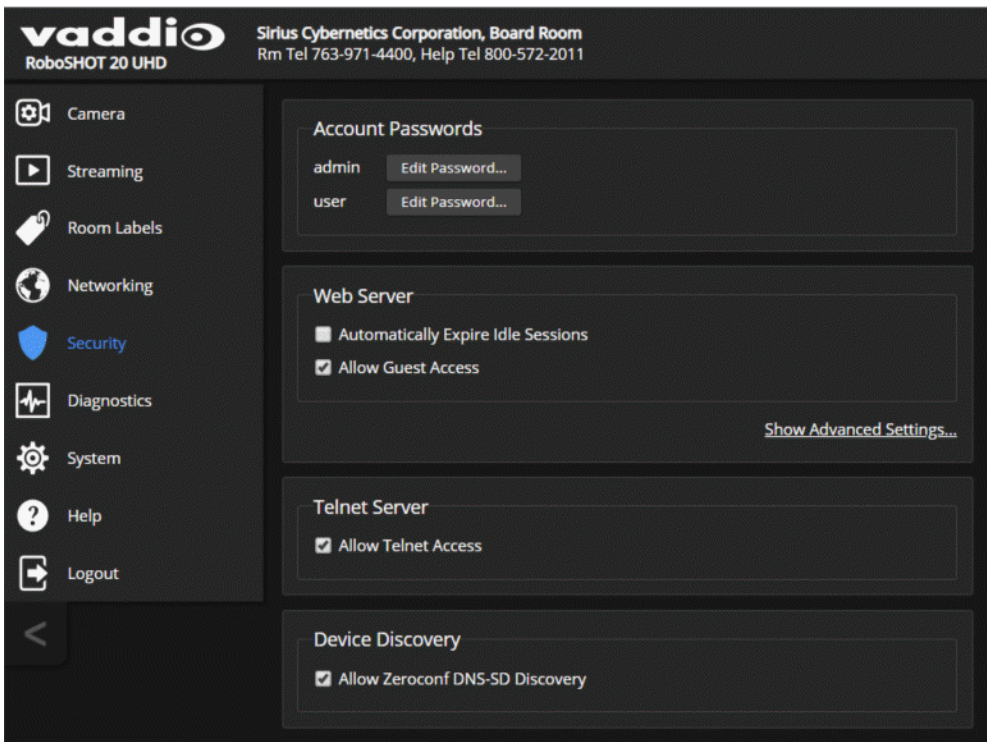

Disabling Telnet Access

SECURITY PAGE

If your installation does not require camera access via Telnet, you may choose to disable the camera's internal Telnet server.

Enabling or Requiring HTTPS

SECURITY PAGE

By default, the web interface uses the HTTP protocol. You can configure the camera's web interface to require a secure HTTPS connection instead.

Caution

Consult your network security professional to manage the camera's SSL certificate. Do not make any changes in the Certificate or Private Key text boxes without guidance from your organization's network security professional.

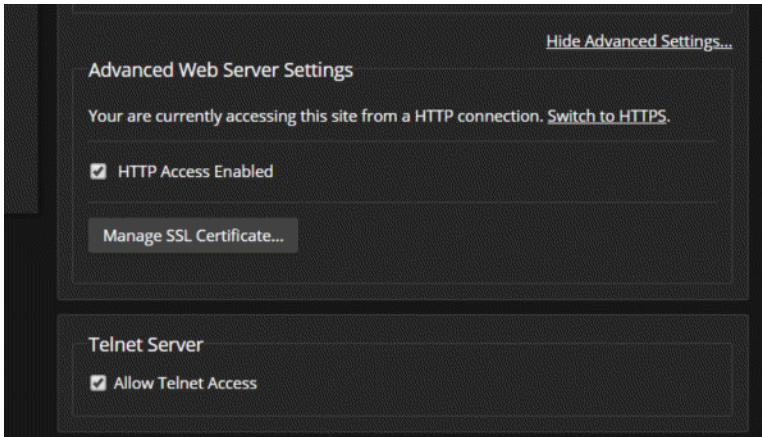

1. Select Show Advanced Settings. The advanced options open.
2. To switch to a secure HTTPS connection, select Switch to HTTPS.

Note

Your browser may present messages warning you that your connection is not secure, because the site's certificate is not valid. This happens when HTTPS is used but no SSL certificate is installed.

3. To require HTTPS connections, clear the box labeled HTTP Access Enabled. The camera's web interface will only be available via an HTTPS connection.

Adding Room Information to the Camera's Web Interface

ROOM LABELS PAGE

The information you enter on this page is displayed on every page of the web interface.

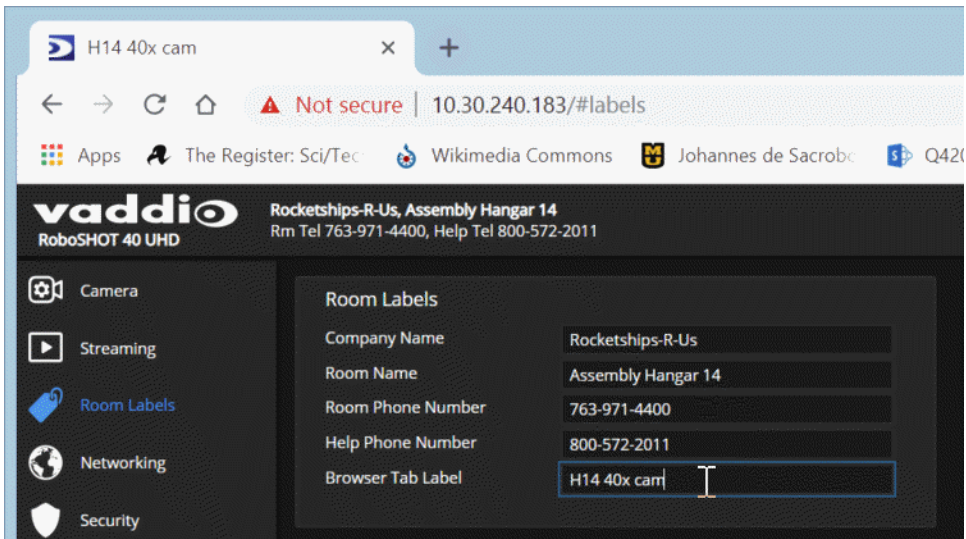

Saving (Exporting) or Restoring (Importing) a Camera Configuration

SYSTEM PAGE, FIRMWARE TAB

You can import a configuration to several cameras if you need to configure them the same way. Cameras must be of the same model, and must have a compatible firmware version installed. Configuration data does not include passwords or unique information such as hostname.

1. Configure the first camera.
2. Export its configuration (Export Data button). The export downloads to your computer as a .dat file. The filename is the camera's hostname.
3. Import the configuration to the other cameras (Import Data button in each camera's web interface).

Note

If the camera is using an older firmware version, it may be unable import a configuration that was exported from a camera using a different version of firmware.

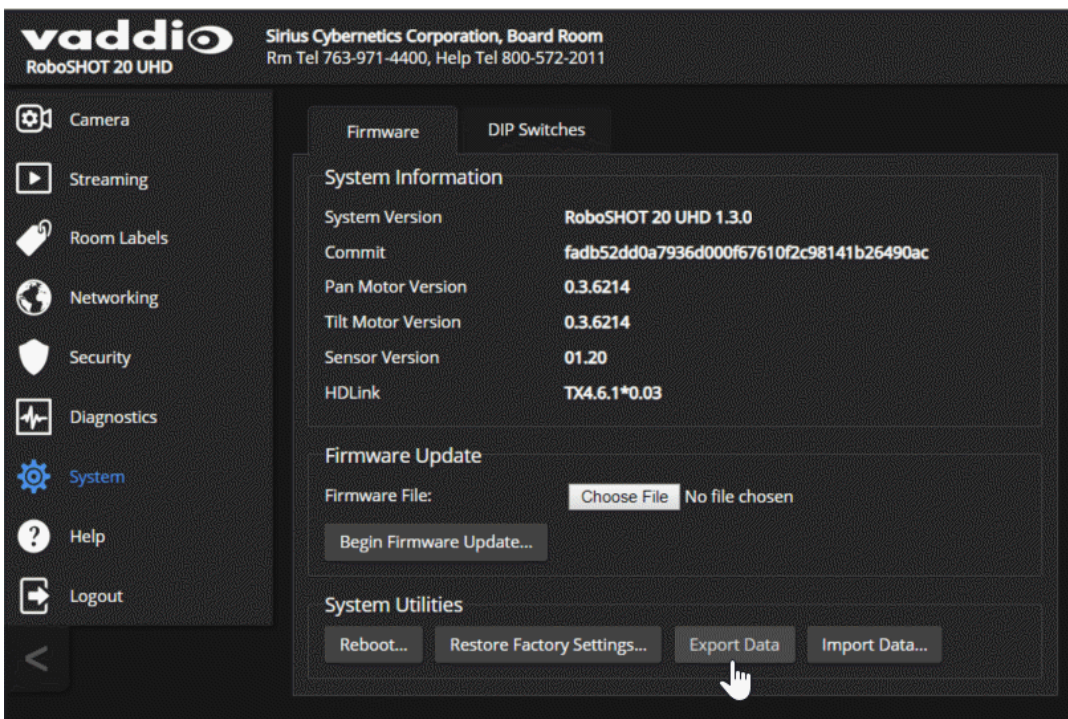

Installing a Camera Firmware Update

SYSTEM PAGE, FIRMWARE TAB

1. Download the firmware and its release notes.
2. Select Choose File, then browse to the downloaded firmware and select it. The filename ends with .p7m.
3. Select Begin Firmware Update.
4. Read and understand the information in the Confirm dialog box. It's dull, but it could save you some time and aggravation.
5. Select Continue. A progress message box opens and the indicator light on the front of the camera turns yellow. If the update process presents warnings or error messages, read them carefully.

The camera reboots when the update is complete.

Caution

The camera must remain connected to power and to the network during the update. Interrupting the update could make the camera unusable.

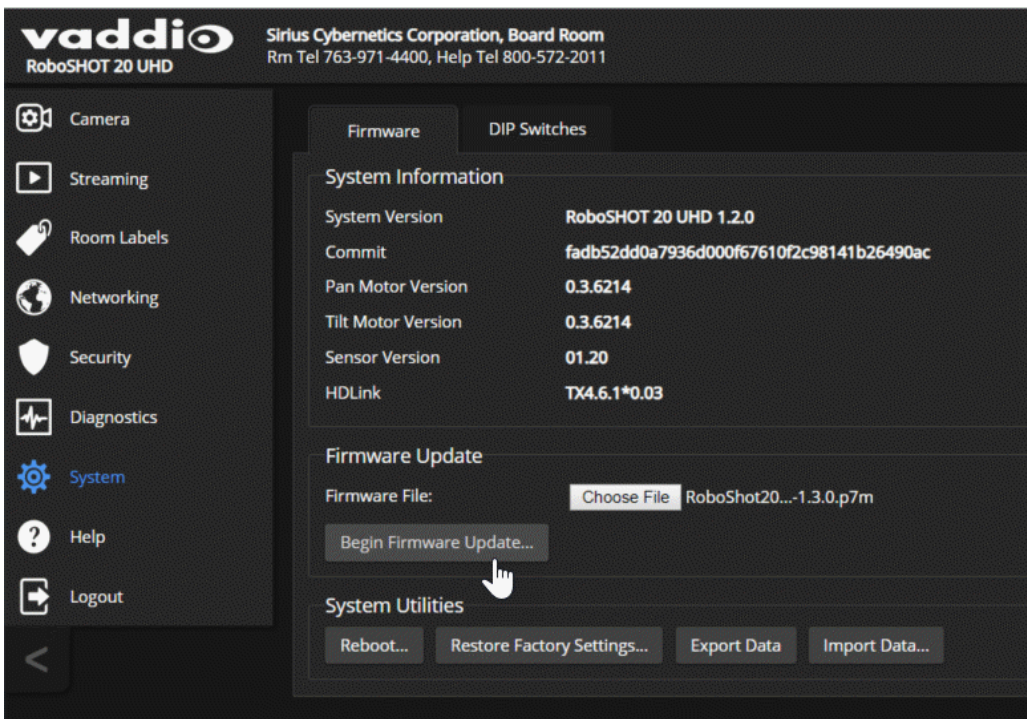

Rebooting the Camera

SYSTEM PAGE, FIRMWARE TAB

This can help if the camera stops responding as you expect.

In the System Utilities section, select Reboot.

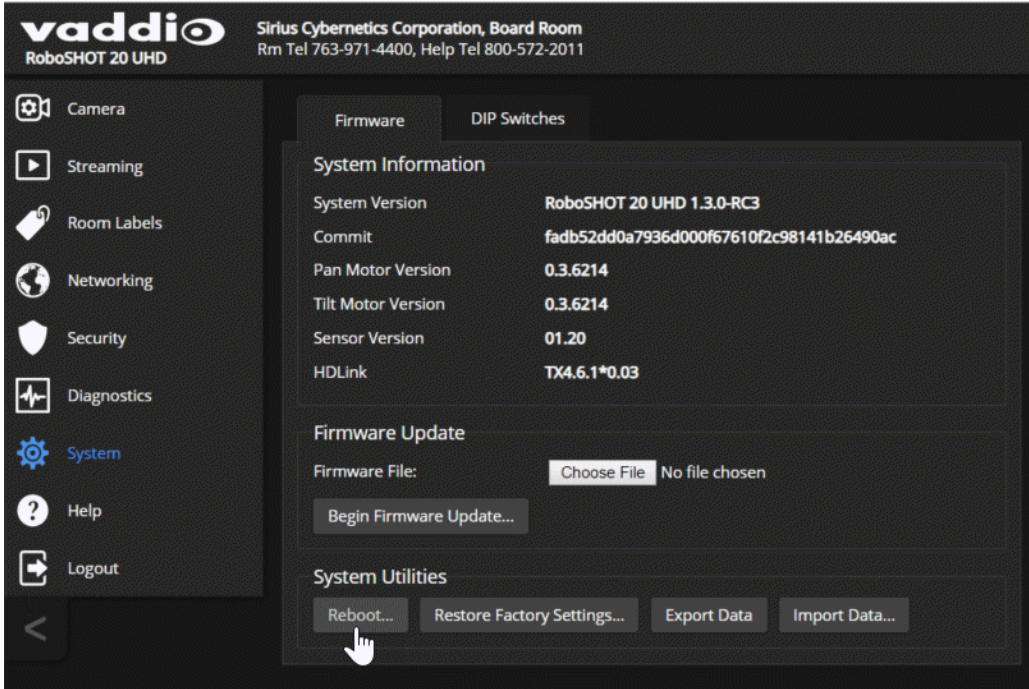

Contacting Vaddio Technical Support

HELP PAGE

If you can't resolve an issue using your troubleshooting skills (or the [Troubleshooting](#) table in this manual), we are here to help.

You'll find information for contacting Vaddio Technical Support on the Help page. The link for support information varies depending on the camera model.

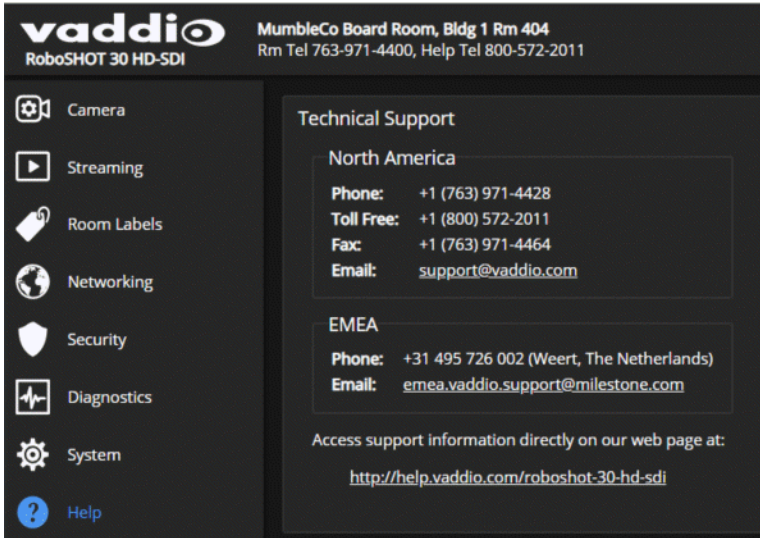

Accessing the Diagnostic Logs

DIAGNOSTICS PAGE

When you contact Vaddio technical support, your support representative may ask you to download and email the log file available from the Diagnostics page.

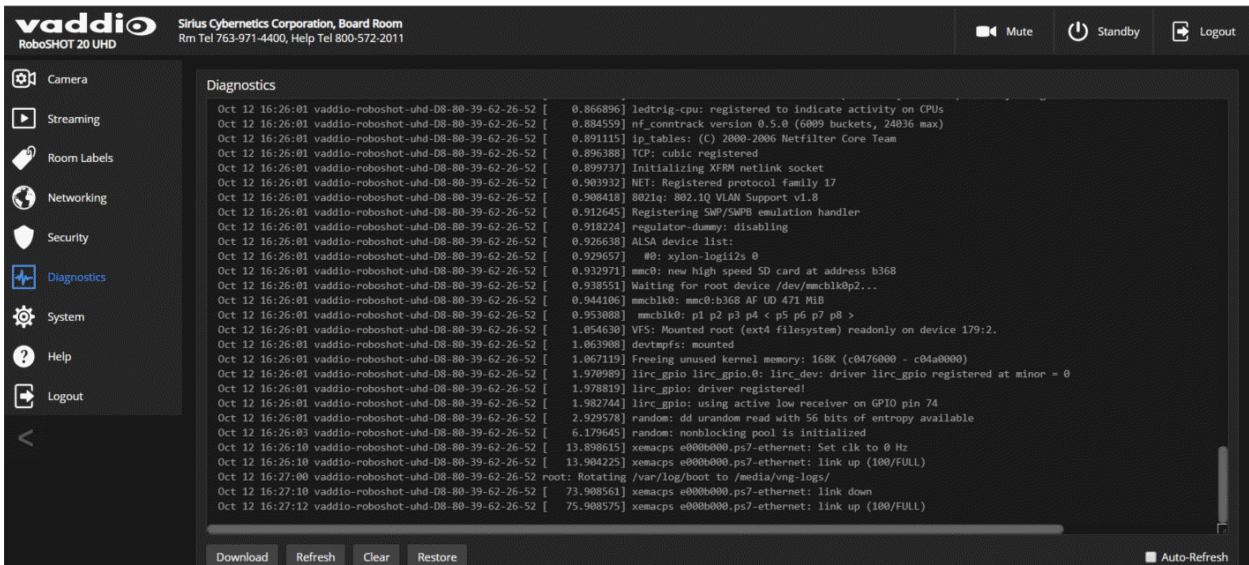

Configuring Camera Behavior

Camera configuration tasks are available on these pages:

- Camera – Color and lighting adjustments, presets (including custom Home), and real-time camera control
- Streaming – Resolution, quality, bandwidth, and more
- System (DIP Switches tab) – Camera identification (Camera 1, 2, or 3 on the remote), status light behavior, codec control mode, and more

Note

Vaddio's RoboSHOT series cameras all have very similar web interfaces. Some of the screen shots in this manual may be from other models in the RoboSHOT series.

Some of the screen shots in this manual are from the RoboSHOT 20 UHD web interface; some are from the RoboSHOT 40 UHD web interface. Any differences will be noted.

Configuring IP Streaming

STREAMING PAGE

IP streaming is enabled by default. *Just as your camera outputs video unless you mute it, the camera also streams except when you disable the stream.*

Two IP streaming protocols are available: RTSP and RTMP.

- RTSP is the camera's default protocol for IP streaming. This delivers an IP stream that people can access from your network using a media player.
- RTMP streaming sends a stream to a content service provider. No local preview is available. To use RTMP streaming, you must have an account with a streaming service.

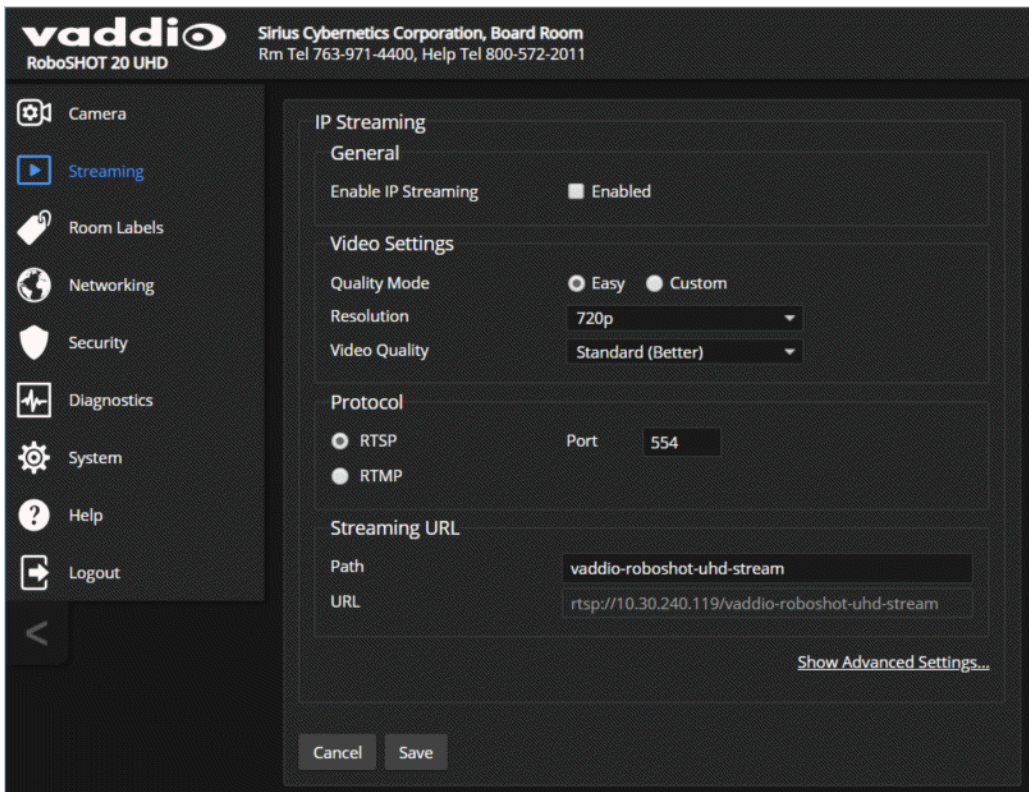

Setting up RTSP Streaming in Easy Mode

STREAMING PAGE

If you are not sure how to configure streaming settings, start with the Easy mode defaults. This configures most settings automatically.

1. Select Easy quality mode.
2. Select the desired IP streaming resolution. This determines the size of the window in which the stream is displayed.

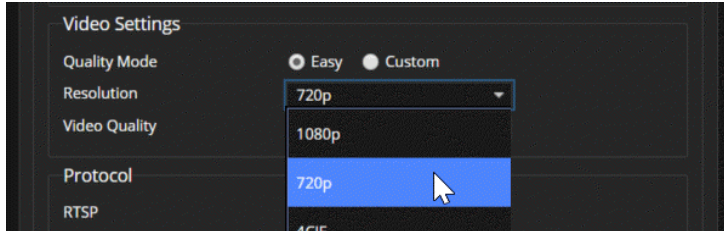

3. Easy quality mode only: Select Video Quality.

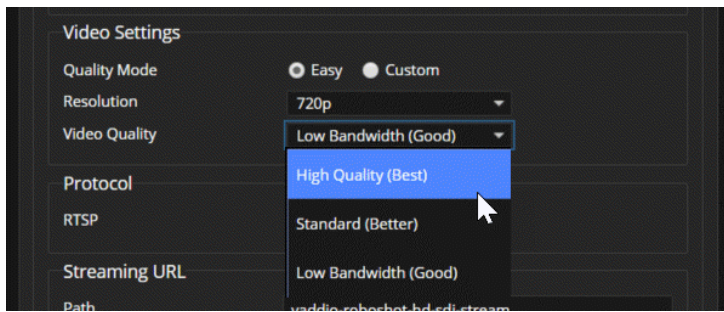

4. Save your changes.

Pro Tip

If streaming video quality is poor, try a lower resolution or bandwidth.

Setting up RTSP Streaming in Custom Mode

STREAMING PAGE

1. Select Custom quality mode.
2. Select the desired resolution.
3. Select the desired IP streaming frame rate.

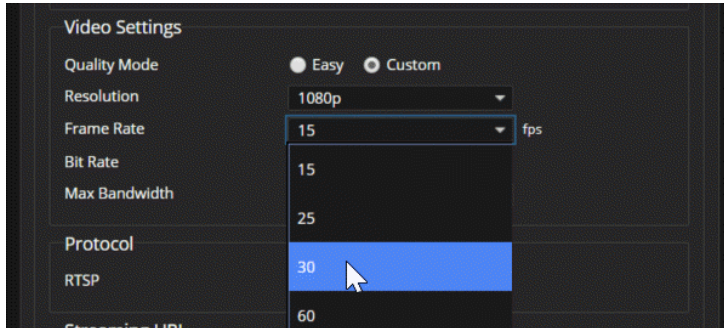

4. Select Constant or Variable bit rate.
5. Constant bit rate only: Set Max Bandwidth.

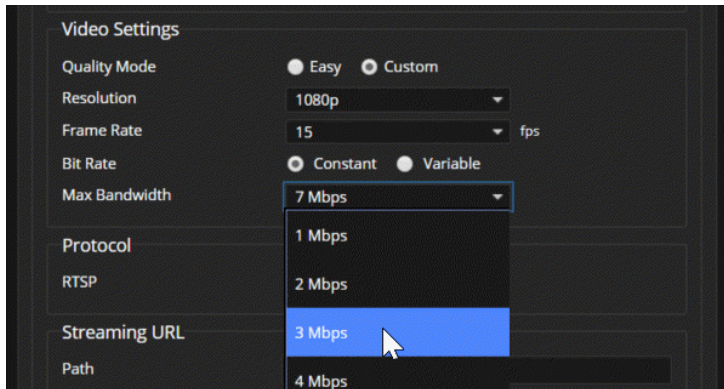

6. Variable bit rate only: Set the Quality (Quantization) slider.

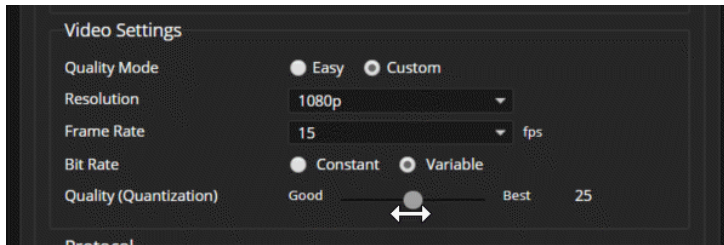

7. Save your changes.

RTSP Streaming Protocol and URL

STREAMING PAGE

RTSP is the default streaming protocol. When IP streaming is enabled, the RTSP stream is automatically available at the streaming URL shown.

RTSP port: Vaddio strongly recommends using the default RTSP port number.

Path: The portion of the streaming URL that appears after the IP address. You may wish to change this to help identify the stream source – for example, `demo-studio-3`.

URL: The location where the stream can be viewed. This will change if you edit the path.

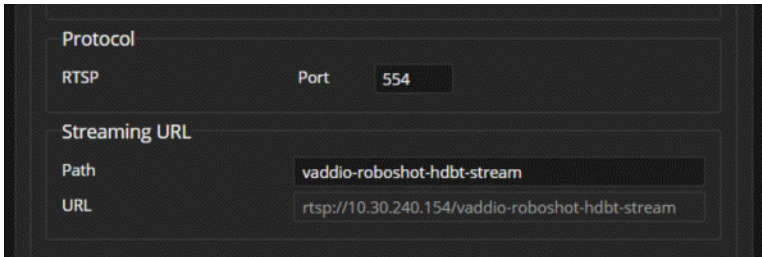

Your camera will present somewhat different information from this image, as the streaming URL incorporates the camera's model and IP address.

To view the RTSP stream:

1. Open a stream viewer such as VLC Media Player.
2. Select "Network stream" or your viewer's equivalent option.
3. Copy the streaming URL from the camera's Streaming page and paste it into the viewer as the URL for the network stream.

Configuring RTMP Streaming

STREAMING PAGE

To use RTMP streaming, you must have an account with a streaming service.

To configure an RTMP streaming service:

1. Select RTMP streaming, and select Settings.

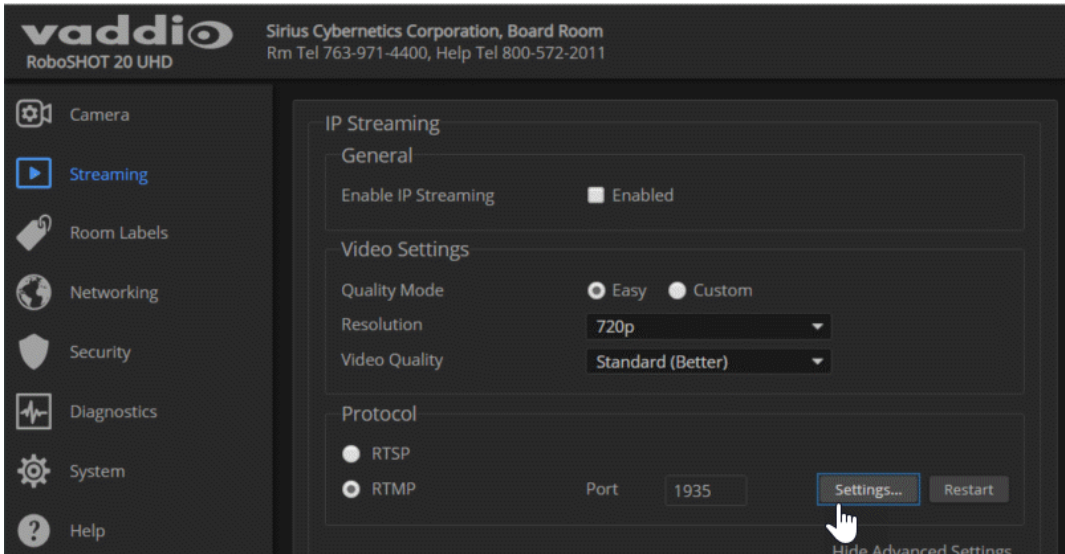

2. Expand the information box for the service.

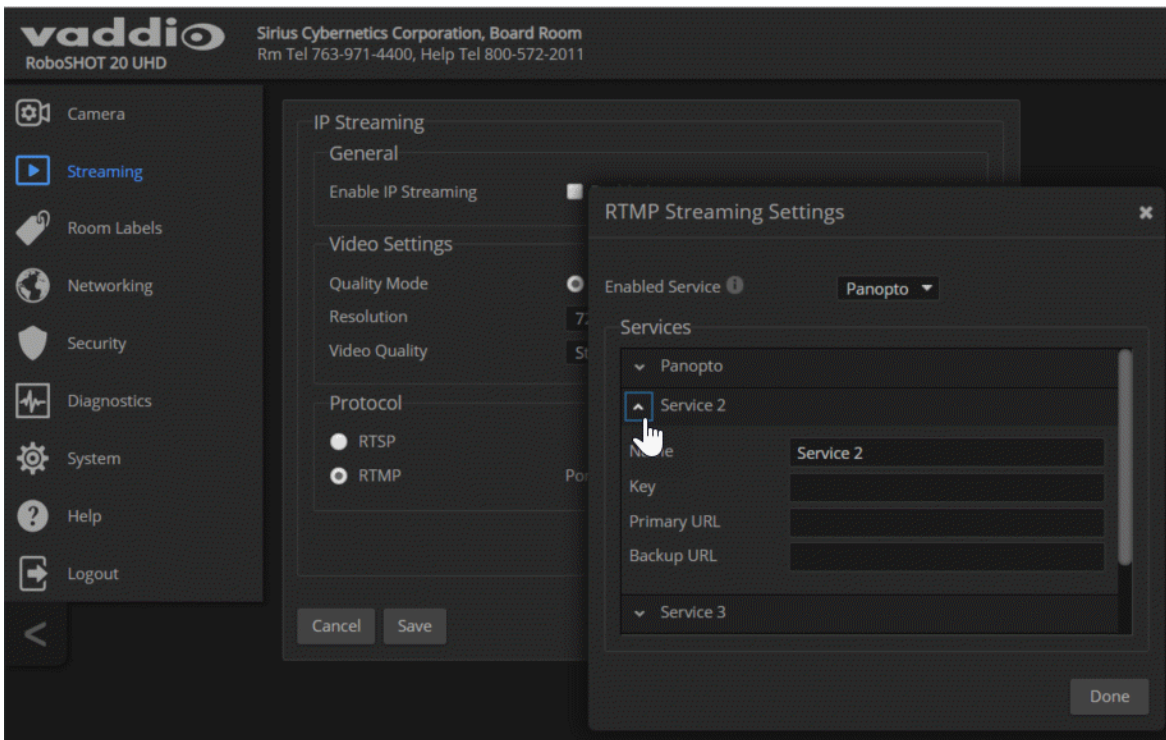

3. Enter the name of the service.
4. Paste in the key and URL(s) provided by the service.

To select the enabled RTMP streaming service:

Expand the list of available streaming services, and select the one to use.

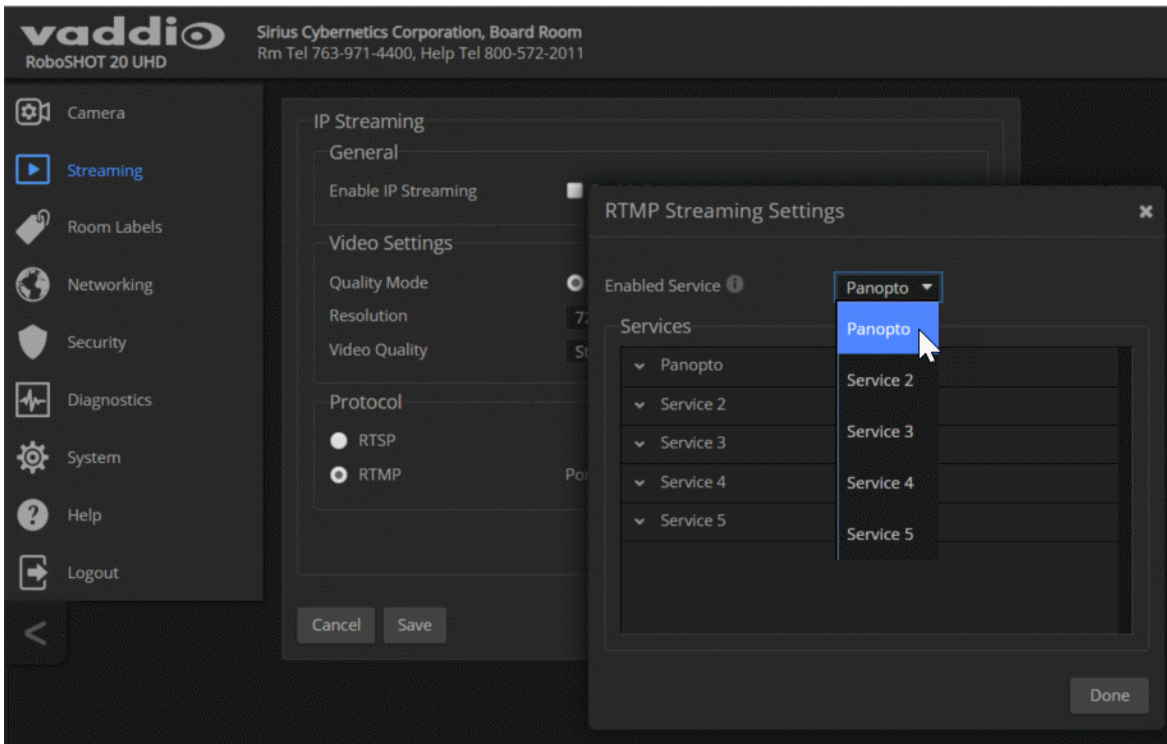

Note

When RTMP streaming is selected and a service is configured, the camera streams to that service until you stop the stream.

Advanced: Changing MTU

STREAMING PAGE

The default packet size for streaming is 1400. Do not change this except in consultation with your network administrator.

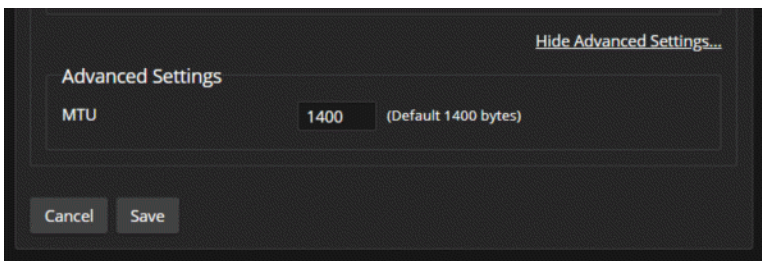
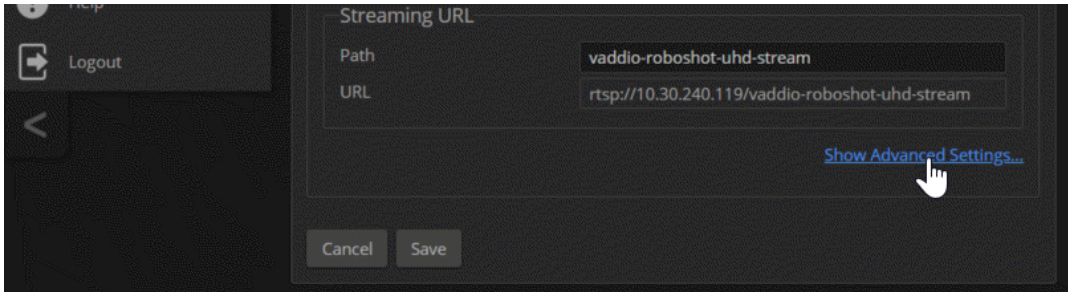

Stopping the IP Stream

STREAMING PAGE

Just as the camera outputs video unless you mute it or put it in standby, the camera also streams except when you disable the stream.

Options:

- **To stop IP streaming entirely:** Clear the Enable IP Streaming check box.
- **To stop the video portion of the stream, but leave the stream running:** Mute the video. This also stops the video locally, so the connected display is blank.
- **To stop sending the stream to a content service provider but make it available as a network stream:** Change from RTMP to RTSP streaming.

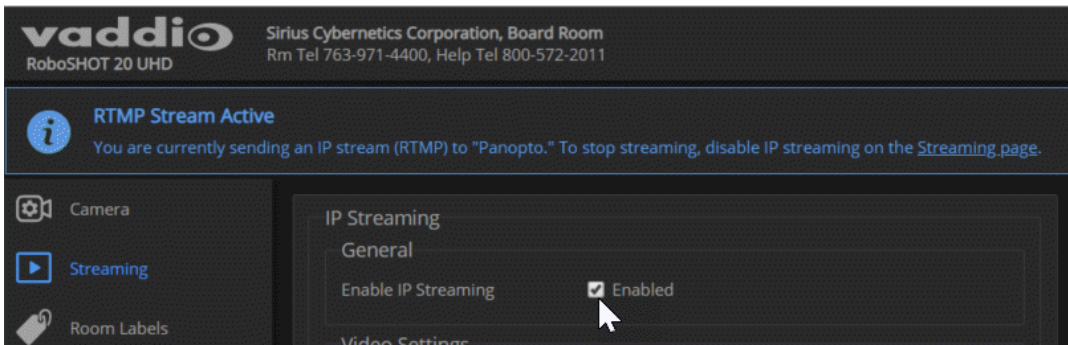

Adjusting the Focus

CAMERA PAGE

Open the Focus control to select Auto-focus, or set manual focus with the + (near) and – (far) buttons. I know you already understand this, but I’m going to say it anyway: The + and – buttons don’t work when Auto Focus is selected.

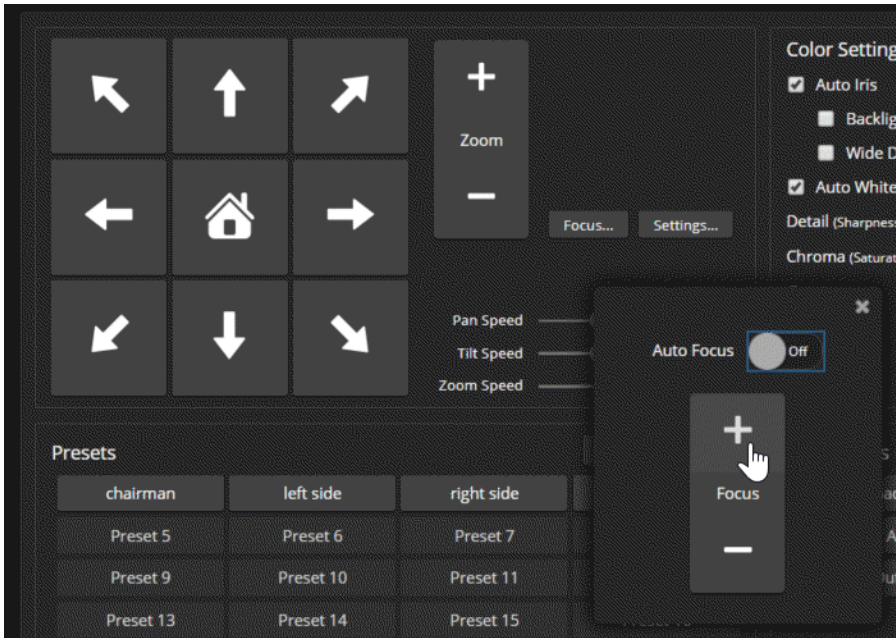

For users who are not logged in as admin, Focus control is available via the IR Remote Commander only.

Defining Video Mute Behavior for the RoboSHOT 40 UHD Camera

By default, Vaddio cameras send black video when video mute is selected.

To set the RoboSHOT 40 UHD camera to send a pattern of color bars instead, open the General tab on the System page and check the Color Bar Generator Enabled box.

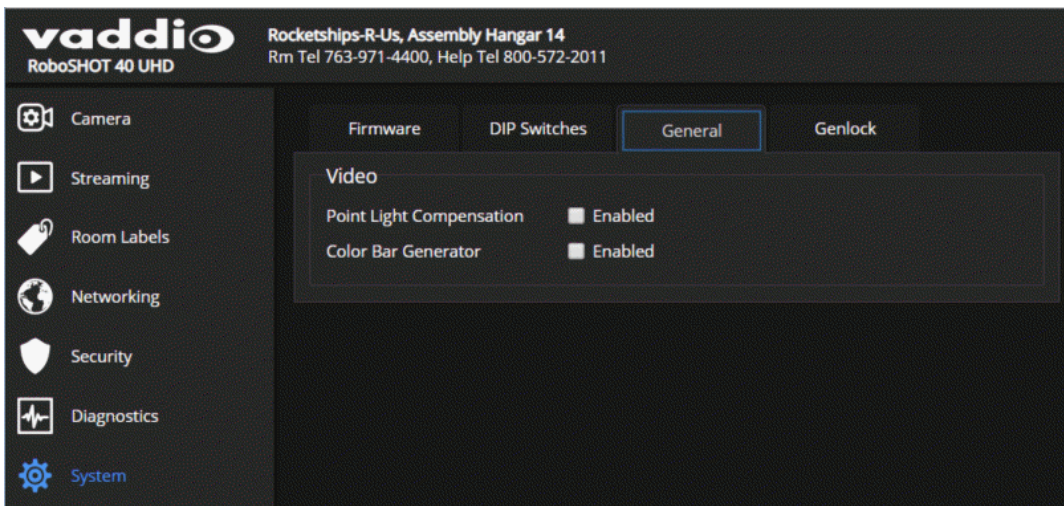

Lighting and Color Adjustments: Setting up Custom CCU Scenes

CAMERA PAGE

No two rooms are exactly alike – but a lot of rooms are a lot alike. The technical folks at Vaddio (Scott, to be specific) have already set up presets for common lighting scenarios (CCU scenes) – Incandescent Hi, Incandescent Lo, Fluorescent Hi, Fluorescent Lo, and Outdoor. The Auto setting allows the camera to determine the appropriate adjustments.

When adjusting for the room lighting, start with a factory-defined CCU scene and adjust as needed. After you customize the camera's color and lighting settings, you can save the adjustments as a custom CCU scene.

Note

Color adjustments are not available when the Auto CCU scene is selected.

To make the initial adjustments:

Click one of the active CCU scene buttons to load a CCU scene into the camera.

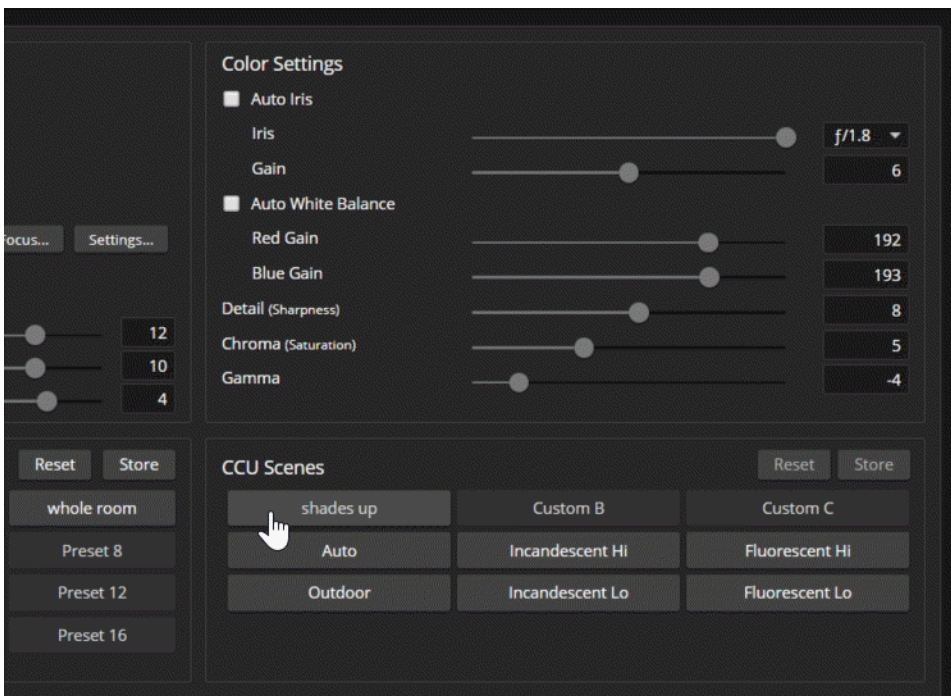

The [Lighting and Image Quality Cheat Sheet](#) and the [Color Adjustment Cheat Sheet](#) may be helpful.

Lighting Adjustments

CAMERA PAGE AND SYSTEM PAGE (GENERAL TAB)

The camera provides settings to compensate for common lighting problems.

Backlight Compensation reduces contrast to adjust for bright light behind the main subject of the shot. Use this if the subject is in front of a window, projector screen, or other bright area and appears as a silhouette. This setting can't be used with Wide Dynamic Range.

Wide Dynamic Range automatically darkens bright areas and brightens dark areas to provide a more properly exposed image in challenging lighting conditions. This setting can't be used with Backlight Compensation.

Point Light Compensation reduces the intensity of small, extremely bright areas (point light sources) that would otherwise swamp the camera with light and make it difficult to see details in areas with less intense lighting. *This setting is only available on the RoboSHOT 40 UHD. It is on the General tab of the System page.*

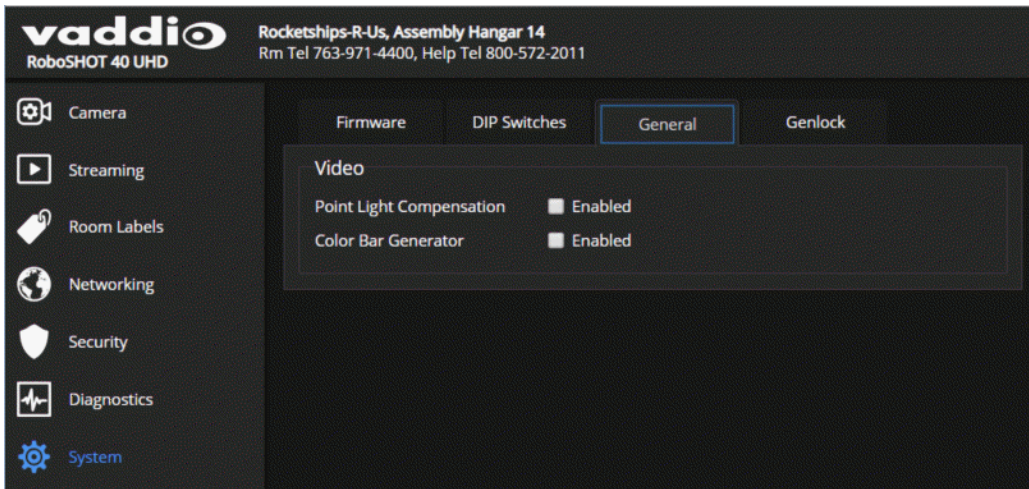

Fine-Tuning Image Quality and Color

CAMERA PAGE

Fine-tune the color and lighting as needed using the Color Settings controls.

- **Auto Iris** allows the camera to compensate automatically for the light level.
- **Auto White Balance** adjusts color automatically. Red gain and blue gain controls are not available when Auto White Balance is selected.
- **Red Gain** and **Blue Gain** provide manual color adjustment.
- **Detail** adjusts the image sharpness. If the video looks grainy or “noisy,” try a lower Detail setting. (As in conversation, too much detail is bad.)
- **Chroma** adjusts the color intensity.
- **Gamma** adjusts the range (grey density) between bright areas and shadows.

If you change Red Gain or Blue Gain and you don't like the results, start over by selecting and then deselecting Auto White Balance.

Saving Color and Lighting Settings

CAMERA PAGE

1. Adjust lighting, image quality, and color.
2. When the scene looks the way you want it to, click Store CCU Scene.
3. In the Store CCU Scene dialog box, select which custom scene to store (Custom A, B, or C) and select Save.

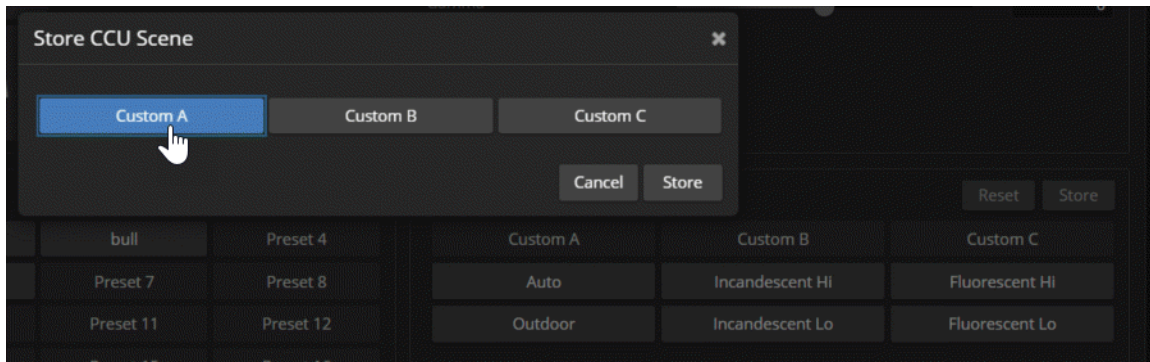

4. Optional: Name the new scene by right-clicking its button. A dialog box opens. Enter the name and save it.



Lighting and Image Quality Cheat Sheet

Here are some tips for using the CCU settings for lighting and image quality. For more detailed information on each setting, see [Lighting Adjustments](#) and [Fine-Tuning Image Quality and Color](#).

What do you need to correct?	Make this adjustment:
The image is too dark	Increase Iris (lower F-stop value)
	Increase Iris Gain
The image looks washed out or faded	Decrease Iris (higher F-stop value)
	Decrease Iris Gain
	Increase Chroma
	Decrease Gamma
The subject is silhouetted against a bright background	Enable Backlight Compensation
Small sources of bright light (point sources) make it hard to see details in areas with less intense lighting.	Enable Point Light Compensation (RoboSHOT 40 UHD only)
Highlights and shadows look right, but mid-tones are too dark.	Increase Gamma
Shadows are too dark	Enable Wide Dynamic Range (WDR)
	Decrease Gamma
The image looks grainy	Decrease Detail
	Decrease Iris Gain
"Soft focus" effect; the image looks unrealistically smooth	Increase Detail

Color Adjustment Cheat Sheet

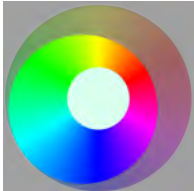
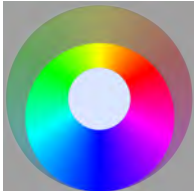
Here are some tips for using the color-related CCU settings. For more detailed information on each setting, see [Fine-Tuning Image Quality and Color](#).

What do you need to correct?	Make this adjustment:
Colors look less vivid than they should	Increase Chroma
Colors look too vivid	Decrease Chroma
Colors look wrong; white objects do not appear white	Enable Auto White Balance
	One Push White Balance
	Disable Auto White Balance and <ul style="list-style-type: none"> ■ adjust Red Gain (decrease for less red, increase for less green) ■ adjust Blue Gain (decrease for less blue, increase for less yellow)
<div style="display: flex; justify-content: space-around; align-items: flex-start;"> <div style="text-align: center;"> <p>Too much red</p>  </div> <div style="text-align: center;"> <p>Not enough red</p>  </div> <div style="text-align: center;"> <p>Too much blue</p>  </div> <div style="text-align: center;"> <p>Not enough blue</p>  </div> <div style="text-align: center;"> <p>Balanced</p>  </div> </div>	

If you are adjusting for lighting conditions that are likely to recur, you can save your adjustments as a custom scene. See [Lighting and Color Adjustments: Setting up Custom CCU Scenes](#).

Setting the Custom Home Position and Other Preset Shots

CAMERA PAGE

The camera's default home position is 0° pan and 0° tilt; you can set a different home position.

You can also define other presets, for shots that you will want to use repeatedly. Presets may include lighting and color settings and may specify Tri-Synchronous Motion or global preset speed settings.

Note

Storing a preset overwrites any information that was previously associated with that preset. The Store Preset dialog does not show which presets have already been defined. Vaddio recommends renaming presets when you store them.

To store a preset or custom home position:

1. Set up the shot.
2. Select Store to open the Store Preset dialog.
3. Select the preset to define, then save it.

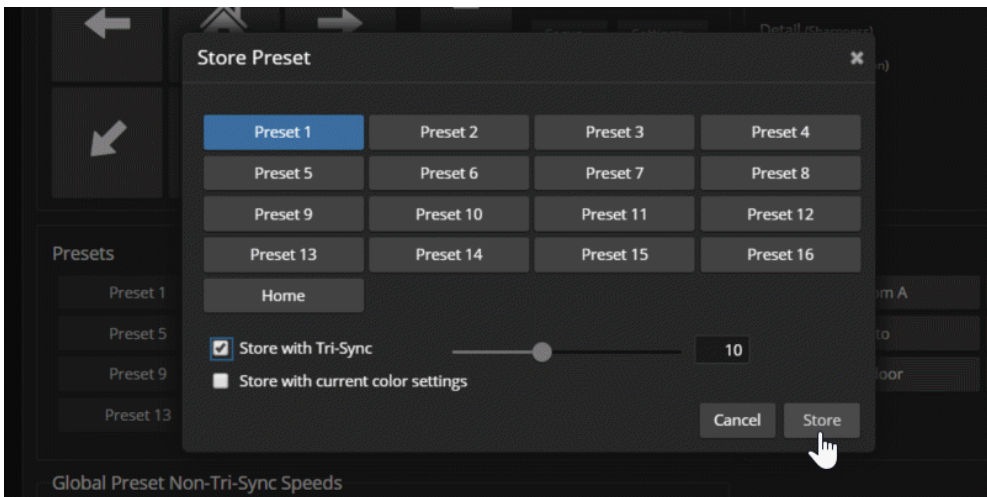

Renaming Presets and Custom CCU Scenes

You can rename presets and custom scenes. The process is the same for both. Right-click the button for the custom scene or preset, and edit the label.



Setting the Speed for Manual Movements

CAMERA PAGE

The Pan Speed, Tilt Speed, and Zoom Speed sliders control how fast the camera moves in response to the direction and zoom controls on the IR remote and in the web interface. These speeds are also used in moving to presets saved without Tri-Synchronous Motion information.

Use the arrow and Zoom controls to check camera speed, and use the Speed sliders to adjust as needed.

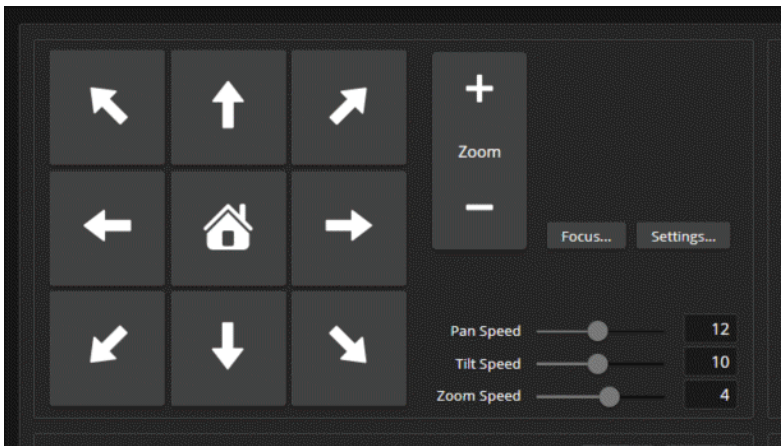

Setting the Direction for Camera Movements

CAMERA PAGE

By default, the arrow buttons on the remote and in the web interface show the direction you would see the camera move if you were looking the same direction as the camera. If a person facing the camera is controlling it with the remote, using the right arrow pans the camera to the person's left.

To make the arrow buttons indicate camera movement from the perspective of a person facing the camera, open the Settings control and invert the pan direction.

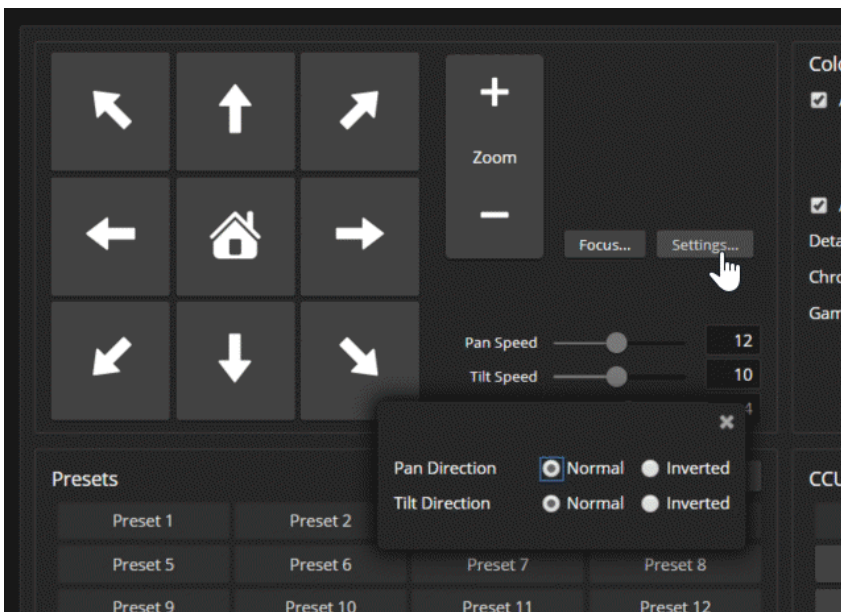

Genlock Settings and Adjustments – RoboSHOT 40 UHD Only

SYSTEM PAGE, GENLOCK TAB

The web interface presents error messages if the camera is not connected to a sync signal source.

The table of valid resolutions shows which resolution is currently selected on the camera.

Genlock

Input Sync Present ✔ Resolution Detected: NTSC
 480i/59.94

Input Sync Valid ✔ Valid

Vertical Offset Lines

Horizontal Offset Pixels

Frame % Offset -50% +50%

Rotary	Camera Resolution	Tri-State Sync		NTSC Black Burst	PAL Black Burst
		1080i/59.94	1080i/50		
0	1080p/59.94	✔		✔	
1	1080p/50		✔		✔
2	1080i/59.94	✔		✔	
3	1080i/50		✔		✔
4	1080p/29.97	✔		✔	
5	1080p/25		✔		✔
6	720p/59.94	✔		✔	
7	720p/50		✔		✔
8	2160p/29.97	✔		✔	
9	2160p/25		✔		✔

Reading the Camera's Switches

SYSTEM PAGE, DIP SWITCHES TAB

Open the DIP Switches tab to see the camera's current switch settings and configure certain camera behaviors.

Note:

Sorry, you have to physically move the physical switch(es) on the back of the camera if you need to change them.

This screen shot shows the DIP Switches tab for the RoboSHOT 20 UHD. Where this camera has rear DIP switches, the RoboSHOT 40 UHD camera has a second array of soft DIP switches with the same functions and labels.

vaddio Sirius Cybernetics Corporation, Board Room
Rm Tel 763-971-4400, Help Tel 800-572-2011
RoboSHOT 20 UHD

Camera | Streaming | Room Labels | Networking | Security | Diagnostics | System | Help | Logout

Firmware | **DIP Switches**

Soft DIP Switches

Color YCbCr	3G Level A	Pro A/V LED Color Scheme	LED On	Standard Control Mode	Enable LED in Standby
Color sRGB	3G Level B	UC LED Color Scheme	LED Off	Codec Control Mode	Disable LED in Standby

Rear DIP Switches

	SW1	SW2	IR 1	IR On	Image Flip Off	BAUD 9600 bps
IR 1	UP	UP	SW1	SW2	SW3	SW4
IR 2	DOWN	UP	IR 2	IR 3	IR Off	Image Flip On
IR 3	UP	DOWN				BAUD 38400 bps

Rear Rotary Switch

0	1080p/59.94	8	2160p/29.97
1	1080p/50	9	2160p/25
2	1080i/59.94	A	
3	1080i/50	B	
4	1080p/29.97	C	
5	1080p/25	D	
6	720p/59.94	E	
7	720p/50	F	

Software Switch Settings – RoboSHOT 40 UHD Only

On the RoboSHOT 20 UHD, these settings are available using the physical switches on the back of the camera. See [Camera Behavior Settings for RoboSHOT 20 UHD](#).

SYSTEM PAGE, DIP SWITCHES TAB

- **IR Settings (Camera ID)** – The IR Remote Commander can control up to three cameras in the same room with different IR frequencies. Use the IR Settings switches to select the frequency to identify the camera as camera 1, camera 2, or camera 3. Refer to the settings table beside the soft DIP switches.
- **IR On/IR Off** – Enable/disable the camera's IR sensors. The camera does not respond to the IR remote if IR is off.
- **Image Flip** – If mounting the camera upside-down, set IMAGE FLIP ON.
- **Baud Rate** – RS-232 serial communication rate (9600 bps or 38400 bps), for communication with a controller via a OneLINK device.

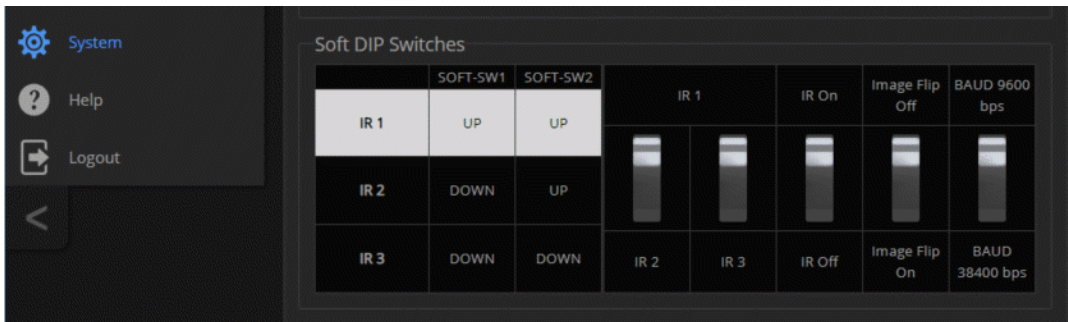

Software Switch Settings – Both Models

SYSTEM PAGE, DIP SWITCHES TAB

The DIP Switches tab of the System page provides access to these features:

- **Color** – YCbCr (default) or sRGB.
- **3G Level A/Level B** – Default is Level A.
- **LED color scheme** – Status light color codes for Pro AV (broadcast, the default setting) or UC (unified conferencing).
- **LED on/off** – When the LED is set to OFF, it remains off even when the camera is sending video.
- **Standard Control Mode/Codec Control Mode** – Select Codec Control Mode if using the camera with a third-party codec.
- **Enable LED in Standby** – When the LED is enabled in standby mode, it illuminates purple to show that the camera is in standby but connected to power. When the LED is disabled in standby mode, it is only on when the camera is active (sending video or updating firmware).

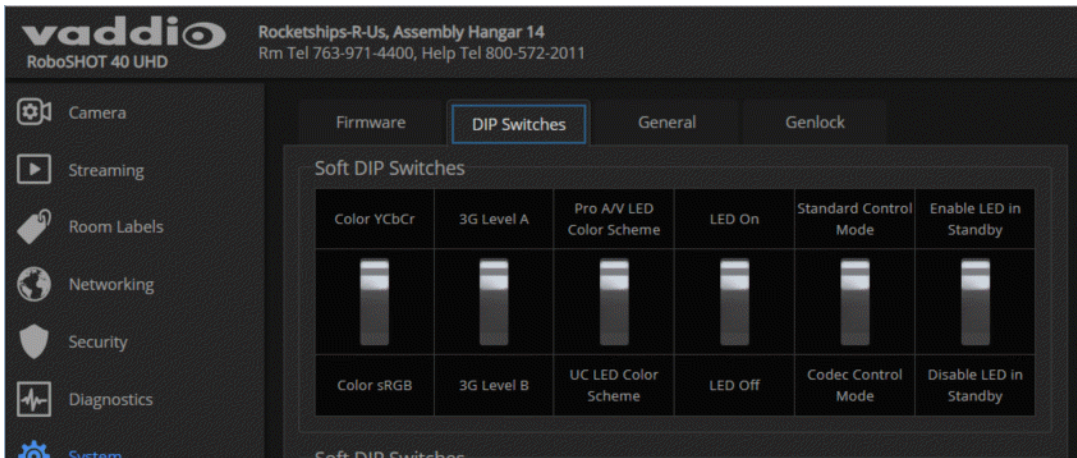

Operating the Camera from the Web Interface

CONTROLS PAGE

The Controls page does not require administrative access. If guest access is enabled, you do not need to log in to access this page. If guest access is disabled, you will need to log in as `user`.

The Controls page provides most of the same controls as the IR Remote Commander.

- Move to camera presets, if any have been stored
- Pan, tilt, zoom, or return it to its home position
- Put the camera in standby or bring it back to the ready state
- Select a custom lighting adjustment, if any have been stored

Since the web interface is specific to the camera you are working with, it does not offer camera selection.

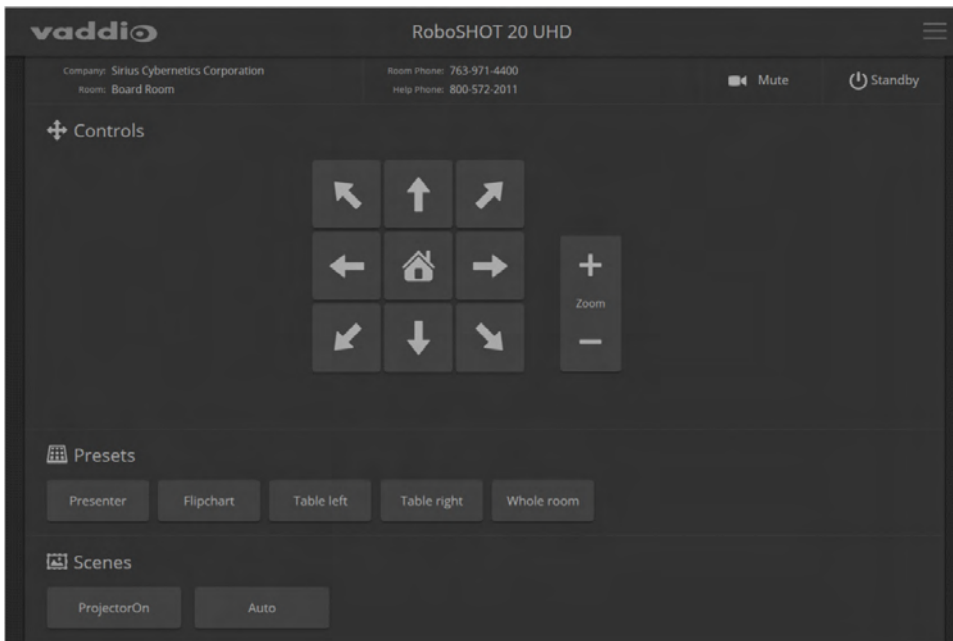

Switching the Camera Off or On (Standby)

Use the Standby button to switch between low-power (standby) and ready states. On entering standby mode, the camera moves to its standby position and stops sending video.

Stop or Resume Sending Video (Mute)

Use the Mute button to stop sending live video without putting the camera in standby mode. When the video is muted, the camera sends a blue or black screen. If the camera is part of a conferencing system, this does not mute the audio.

Moving the Camera

Use the arrow buttons for camera pan and tilt. The center button moves the camera to the home position.

Zooming In or Out

Use the Zoom + button to zoom in and the Zoom - button to zoom out.



Moving the Camera to a Preset Position

Presets are camera shots that have been stored. They include pan, tilt, and zoom information, and may include color and speed information as well. If no presets are defined, the Controls page does not present the Presets section.

Use the Preset buttons to move the camera to any of its preset positions.

Adjusting the Color and Lighting

If any color and lighting adjustments (CCU scenes) have been saved, they are available in the Scenes area, along with the Auto setting. In most cases, the Auto setting is appropriate. This setting allows the camera to adjust to current conditions automatically.

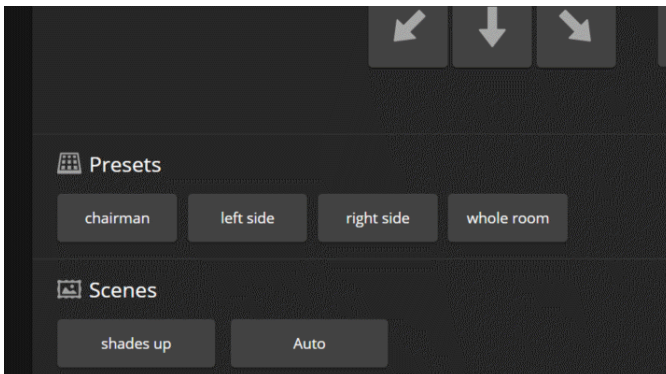

Telnet Command Reference

Vaddio's Telnet command protocol allows external devices to control the camera. It is a high-level, text-based command line interface supported via Telnet session to the camera.

Network connectivity and a Telnet client are required; Telnet port 23 is used. Telnet sessions require the administrator account login.

In addition to the camera control commands, Telnet session management commands are available - help, history, and exit.

```

Telnet 192.168.1.66
BoardroomCamControl login: admin
Password:
Last login: Wed Mar 30 13:19:52 -0500 2016 on /dev/tty0
*****
Vaddio Interactive Shell
*
* WARNING: Authorized Access Only
*****
Welcome admin
? version
Serial      25120cea444ca884c4282702a214efba9e5e06c7
System Version PCC Premier 1.1.0-RC3
OK
? network settings get
Name       eth0 WDM
MAC Address 60:1E:C0:8D:69:58
IP Address 192.168.1.66
Netmask    255.255.255.0
VLAN       Disabled
Gateway    192.168.1.254
OK

```

Things to know about Telnet:

- The > character is the command prompt.
- Using a question mark as a command parameter will bring up a list of available subcommands or parameters. Example:

```

camera focus ?
camera focus
near      Focus the camera near
far       Focus the camera far
stop      Stop the camera focus
mode      Camera focus mode

```

- CTRL-5 clears the current serial buffer on the device.

Typographical conventions used in this manual:

- { **x** | **y** | **z** } – Choose x, y, or z. Example: camera led { on | off | toggle }
- <**variable**> – Substitute the desired value here. Example: camera ccu get <param>
- < **x** - **y** > – Valid range of values is from x through y. Example: camera ccu set detail <0 -15>
- [**parameter**] – Parameter is not required. Example: camera pan left [<speed>]

camera home

Moves the camera to its home position.

Synopsis	camera home
Example	<pre>>camera home OK ></pre>

camera pan

Moves the camera horizontally.

Synopsis	camera pan { left [<speed>] right [<speed>] stop get set }	
Options	left	Moves the camera left.
	right	Moves the camera right.
	speed <1 – 24>	Optional: Specifies the pan speed as an integer (1 to 24). Default speed is 12.
	stop	Stops the camera's horizontal movement.
	get	Returns the camera's current pan position.
	set <position>	Sets the camera's absolute pan position in degrees, as a floating point value between approximately -150.00 and 150.00. This is the minimum range. Individual cameras may have an additional degree or two of travel before they reach their physical limits. If the value is out of range, the camera returns an error message and no motion occurs.
Examples	<pre>>camera pan left OK ></pre> <p>Pans the camera left at the default speed.</p> <pre>>camera pan right 20 OK ></pre> <p>Pans the camera right using a speed of 20.</p> <pre>>camera pan stop OK ></pre> <p>Stops the camera's horizontal motion.</p>	

camera tilt

Moves the camera vertically.

Synopsis	camera tilt{ up [<speed>] down [<speed>] stop get set}	
Options	up	Moves the camera up.
	down	Moves the camera down.
	speed <1 – 20>	Optional: Specifies the tilt speed as an integer (1 to 20). Default speed is 10.
	stop	Stops the camera's vertical movement.
	get	Returns the camera's current tilt position.
	set <position>	Sets the camera's absolute tilt position in degrees, as a floating point value between approximately -30.00 and 90.00. This is the minimum range; individual cameras may have an additional degree or two of travel before they reach their physical limits. If the value is out of range, the camera returns an error message and no motion occurs.
Examples	<pre>>camera tilt up OK ></pre> <p>Tilts the camera up at the default speed.</p> <pre>>camera tilt down 20 OK ></pre> <p>Tilts the camera down using a speed of 20.</p> <pre>>camera tilt stop OK ></pre> <p>Stops the camera's vertical motion.</p>	

camera zoom

Zooms the camera in toward the subject or out away from the subject.

Synopsis	camera zoom { in [<speed>] out [<speed>] stop get set}	
Options	in	Moves the camera in.
	out	Moves the camera out.
	speed [1 – 7]	Optional: Specifies the zoom speed as an integer (1 to 7). Default speed is 3.
	stop	Stops the camera's zoom movement.
	get	Returns the camera's current zoom level.
	set <1 – n>	Sets the zoom level as an integer value. The value of n (maximum zoom) depends on the camera's capabilities. For example, the range is 1 to 12 for a 12x camera. If the value is out of range, the camera returns an error message and no zoom change occurs.
Examples	<pre>>camera zoom in OK > Zooms the camera in at the default speed. >camera zoom out 7 OK > Zooms the camera out using a speed of 7. >camera zoom stop OK > Stops the camera's zoom motion. >camera zoom set 14 OK > Sets the camera's zoom level to 14x. >camera zoom get 14 OK > Returns the camera's current zoom level.</pre>	

camera focus

Changes the camera focus.

Synopsis	<code>camera focus { near [<speed>] far [<speed> stop mode {get auto manual}}</code>	
Options	<code>near</code>	Brings the focus nearer to the camera. Can only be used when camera is in manual mode.
	<code>far</code>	Moves the focus farther from the camera. Can only be used when camera is in manual mode.
	<code>speed <1 – 8></code>	Optional: integer (1 to 8) specifies the focus speed.
	<code>stop</code>	Stops the camera's focus movement.
	<code>mode {get auto manual}</code>	Returns the current focus mode, or specifies automatic or manual focus.
Examples	<pre> camera focus near OK > </pre> <p>Brings the focus near at the default speed.</p> <pre> camera focus far 7 OK > </pre> <p>Moves the focus farther from the camera at a speed of 7.</p> <pre> camera focus mode get auto_focus: on OK > </pre> <p>Returns the current focus mode.</p>	



camera preset

Moves the camera to the specified preset, or stores the current camera position and optionally CCU information, either with or without specifying that Tri-Synchronous Motion is to be used when moving to this position.

Note

This command corresponds to the CAM_Memory commands in the RS-232 command set.

Synopsis	camera preset { recall store} <1 – 16> [tri-sync <1 – 24>] [save-ccu]	
Options	recall <1 – 16>	Moves the camera to the specified preset, using Tri-Synchronous Motion if this was saved with the preset. If CCU information was saved with the preset, the camera switches to the CCU setting associated with the preset.
	store <1 – 16>	Stores the current camera position as the specified preset.
	tri-sync <1 – 24>	Optional: Specifies that the camera uses Tri-Synchronous Motion to move to this position, using the specified speed.
	save-ccu	Optional: Saves the current CCU settings as part of the preset. If not specified, the last color settings are used when recalled.
Examples	<pre>>camera preset recall 3 OK ></pre> <p>Moves the camera to preset 3.</p> <pre>>camera preset store 1 OK ></pre> <p>Saves the camera's current position as preset 1.</p> <pre>>camera preset store 4 tri-sync 15 OK ></pre> <p>Stores the camera's current position as preset 4. The camera will use Tri-Synchronous Motion at speed 15 when it is recalled to this preset.</p> <pre>>camera preset store 2 save-ccu OK ></pre> <p>Stores the camera's current position as preset 2. The camera applies the current CCU settings when it is recalled to this preset.</p>	

camera ccu get

Returns CCU (lighting and color) information.

Synopsis	<code>camera ccu get <param></code>	
	all	Returns all current CCU settings.
	auto_white_balance	Returns the current state of the auto white balance setting (on or off).
	red_gain	Returns red gain as an integer (0 to 255).
	blue_gain	Returns blue gain as an integer (0 to 255).
	backlight_compensation	Returns the current state for backlight compensation (on or off).
	auto_iris	Returns the current auto-iris state (on or off).
	iris	Returns the iris value as an integer (0 to 11).
	gain	Returns gain as an integer (0 to 11).
	detail	Returns detail as an integer (0 to 15).
	chroma	Returns chroma as an integer (0 to 14).
	gamma	Returns gamma as an integer (-64 to 64)
	wide_dynamic_range	Returns the current state for Wide Dynamic Range (on or off). Not available for RoboSHOT 20 UHD.
Examples	<pre>>camera ccu get iris iris 6 OK ></pre> <p>Returns the current iris value.</p> <pre>>camera ccu get red_gain red_gain 201 OK ></pre> <p>Returns the current red gain value.</p> <pre>>camera ccu get all auto_iris on auto_white_balance on backlight_compensation off blue_gain 193 chroma 2 detail 8 gain 3 iris 11 red_gain 201 wide_dynamic_range off OK ></pre> <p>Returns all current CCU settings.</p>	

camera ccu set

Sets the specified CCU (lighting and color) information.

Synopsis	camera ccu set <param> <value>	
Options 	auto_white_balance {on off}	Sets the current state of the auto white balance setting (on or off). Auto white balance overrides red gain and blue gain manual settings.
	red_gain <0 – 255>	Sets the red gain value as an integer (0 to 255). Can only be used when auto white balance is off.
	blue_gain <0 – 255>	Sets the blue gain value as an integer (0 to 255). Can only be used when auto white balance is off.
	backlight_compensation {on off}	Sets the current state of the backlight compensation setting (on or off). Can only be used when wide dynamic range mode is off.
	iris <0 – 11>	Sets the iris value as an integer (0 to 11). Can only be used when auto-iris is off.
	auto_iris {on off}	Sets the auto-iris state (on or off). Auto-iris disables manual iris and gain when it is on.
	gain <0 – 11>	Sets gain value as an integer (0 to 11). Can only be used when auto-iris is off.
	detail <0 – 15>	Sets the detail value as an integer (0 to 15).
	chroma <0 – 14>	Sets the chroma value as an integer (0 to 14).
	gamma <-64 – 64>	Sets the gamma value as an integer (-64 to 64).
	wide_dynamic_range {on off}	Sets Wide Dynamic Range mode on or off. Can only be used when backlight compensation is off. Not available for RoboSHOT 20 UHD.
Examples	<pre>>camera ccu set auto_iris off OK > Turns off auto-iris mode, returning the camera to manual iris control. >camera ccu set red_gain 10 OK > Sets the red gain value to 10.</pre>	

camera ccu scene

Stores the current CCU scene or recalls the specified ccu scene.

Synopsis	camera ccu scene {recall {factory <1–6> custom <1–3>} store custom <1–3>}	
Options	recall factory <1–6> recall custom <1–3>	Recalls the camera to the specified scene (factory 1 to 6 or custom 1 to 3) .
	store custom <1–3>	Saves the current scene as the specified custom scene.
Examples	<pre>>camera ccu scene recall factory 2 OK > Sets the camera to use factory CCU scene 2. >camera ccu scene store custom 1 OK > Saves the current CCU scene as custom CCU scene 1.</pre>	

camera led

Set or change the behavior of the indicator light.

Synopsis	camera led { get off on }	
Options	get	Returns the indicator light's current state (on or off).
	off	Disables the indicator light.
	on	Enables the indicator light.
Examples	<pre>>camera led off OK > Disables the indicator light. You cannot tell by looking at the camera whether it is sending video. >camera led get led: on OK > Returns the current state of the indicator light.</pre>	

camera standby

Set or change camera standby status.

Synopsis	camera standby { get off on toggle }	
Options	get	Returns the camera's current standby state.
	off	Brings the camera out of standby (low power) mode.
	on	Stops video and puts the camera in standby mode.
	toggle	Changes the camera's standby state – if it was not in standby mode, it enters standby; if it was in standby mode, it "wakes up."
Examples	 <pre>>camera standby off OK > Brings the camera out of standby mode. >camera standby get standby: on OK > Returns the current standby state.</pre>	

video mute

Gets or sets the camera's video mute status. When video is muted, the camera sends black video with an on-screen message stating that video mute is on. This can be desirable when preparing the room or when privacy is needed.

Synopsis	video mute { get off on toggle }	
Parameters	get	Returns the current video mute status.
	off	Unmutes the video. Normal video resumes.
	on	The connected display shows either a black screen with a message or a color-bar pattern. (The color-bar option is only available on the RoboSHOT 40 UHD camera.)
	toggle	Changes the camera's video mute status.
Examples	<pre>video mute get mute: off Returns video mute status.</pre>	
	<pre>video mute on Transmits black video.</pre>	

streaming settings get

Retrieves IP streaming settings. These are configured in the web interface.

Synopsis	streaming settings get	
Parameters	IP Custom_Frame_Rate	Frame rate selected in Custom quality mode.
	IP Custom_Resolution	Resolution selected in Custom quality mode.
	IP Enabled	True if IP streaming is enabled, False if it is not.
	IP MTU	Maximum packet size.
	IP Port	The port number used for IP streaming. The default port for RTSP streaming is 554; default for RTMP streaming is 1935.
	IP Preset_Quality	Video quality selected in Easy video quality mode.
	IP Preset_Resolution	Resolution selected in Easy video quality mode.
	IP Protocol	The IP streaming protocol in use (RTSP or RTMP).
	IP URL	The URL where the RTSP stream is available.
	IP Video_Mode	Video quality mode selected (preset or custom)
Example	<pre>>streaming settings get IP Custom_Frame_Rate 30 IP Custom_Resolution 1080p IP Enabled true IP MTU 1400 IP Port 554 IP Preset_Quality Standard (Better) IP Preset_Resolution 720p IP Protocol RTSP IP URL vaddio-roboshot-uhd-stream IP Video_Mode preset OK ></pre> <p>Returns the current streaming settings.</p>	

streaming ip enable

Set or change the state of IP streaming.

This command is currently available only for RoboSHOT 40 UHD.

Synopsis	streaming ip enable { get on off toggle }	
Parameters	get	Returns the current state of IP streaming
	on	Enables IP streaming.
	off	Disables IP streaming.
	toggle	Changes the state of IP streaming (on if it was off, or off if it was on). streaming ip enable toggle has the same effect as selecting the Enable IP Streaming checkbox in the web interface.
Example	<pre>>streaming ip enable on > OK Enables IP streaming. >streaming ip enable get enabled: true > OK Returns the current state of IP streaming.</pre>	

network ping

Sends an ICMP ECHO_REQUEST to the specified IP address or hostname.

Synopsis	network ping [count <count>] [size <size>] <destination-ip>	
Options	<count>	The number of ECHO_REQUEST packets to send. Default is five packets.
	<size>	The size of each ECHO_REQUEST packet. Default is 56 bytes.
	<destination-ip>	The IP address where the ECHO_REQUEST packets will be sent.
Examples	<pre>>network ping 192.168.1.66 PING 192.168.1.66 (192.168.1.66): 56 data bytes 64 bytes from 192.168.1.66: seq=0 ttl=64 time=0.476 ms 64 bytes from 192.168.1.66: seq=1 ttl=64 time=0.416 ms 64 bytes from 192.168.1.66: seq=2 ttl=64 time=0.410 ms 64 bytes from 192.168.1.66: seq=3 ttl=64 time=0.410 ms 64 bytes from 192.168.1.66: seq=4 ttl=64 time=3.112 ms --- 192.168.1.66 ping statistics --- 5 packets transmitted, 5 packets received, 0% packet loss round-trip min/avg/max = 0.410/0.964/3.112 ms > Sends five ECHO_REQUEST packets of 56 bytes each to the host at 192.168.1.66.</pre>	
	<pre>>network ping count 10 size 100 192.168.1.1 Sends 10 ECHO_REQUEST packets of 100 bytes each to the host at 192.168.1.1. The command returns data in the same form as above.</pre>	

network settings get

Returns the current network settings for MAC address, IP address, subnet mask, and gateway.

Synopsis	<code>network settings get</code>
Example	<pre>> network settings get Name eth0:WAN MAC Address 48:6F:77:64:79:21 IP Address 192.168.1.67 Netmask 255.255.255.0 VLAN Disabled Gateway 192.168.1.254 OK ></pre>

system reboot

Reboots the system either immediately or after the specified delay. Note that a reboot is required when resetting the system to factory defaults (system factory-reset).

Synopsis	<code>system reboot [<seconds>]</code>	
Options	<code><seconds></code>	The number of seconds to delay the reboot.
Examples	<pre>>system reboot OK > The system is going down for reboot NOW! roboshot-uhd-48-6F-77-64-79-21 Reboots the system immediately. >system reboot 30 Reboots the system in 30 seconds. The response is in the same form; the system message appears at the end of the delay.</pre>	

system factory-reset

Gets or sets the factory reset status. When the factory reset status is on, the system resets to factory defaults on reboot.

Synopsis	<code>system factory-reset { get on off }</code>	
Options	<code>get</code>	Returns the camera's current factory reset status.
	<code>on</code>	Enables factory reset on reboot.
	<code>off</code>	Disables factory reset on reboot.
Examples 	<pre>>system factory-reset get factory-reset (software): off factory-reset (hardware): off OK ></pre> <p>Returns the factory reset status.</p> <p>This evaluates the most recent <code>system factory-reset on</code> or <code>off</code> command, if one has been received, then reads the rear panel DIP switches and returns the status <code>on</code> if they are all in the down position.</p> <pre>>system factory-reset on factory-reset (software): on factory-reset (hardware): off OK ></pre> <p>Enables factory reset upon reboot.</p> <p>Note <i>This command does not initiate a factory reset. The factory reset takes place on the next reboot.</i></p>	

history

Returns the most recently issued commands from the current Telnet session. Since many of the programs read user input a line at a time, the command history is used to keep track of these lines and recall historic information.

Synopsis	history <limit>	
Options	<limit>	Integer value specifying the maximum number of commands to return.
Examples	<p>history Displays the current command buffer.</p> <p>history 5 Sets the history command buffer to remember the last 5 unique entries.</p>	
Additional information	<p>You can navigate the command history using the up and down arrow keys.</p> <p>This command supports the expansion functionality from which previous commands can be recalled from within a single session. History expansion is performed immediately after a complete line is read.</p> <p>Examples of history expansion:</p> <ul style="list-style-type: none"> * !! Substitute the last command line. * !4 Substitute the 4th command line (absolute as per 'history' command) * !-3 Substitute the command line entered 3 lines before (relative) 	



version

Returns the current firmware version.

Synopsis	version
Example	<pre>> version Commit d033ddb2378357a871011eb820706dcaa64ec0e2 HDLink TX4.6.1*0.03 Pan Motor Version 0.32.6214 Sensor Version 01.20 System Version RoboSHOT 20 UHD 1.3.0 Tilt Motor Version 0.3.6214 OK Returns current firmware version information. Your camera may return slightly different information.</pre>

help

Displays an overview of the CLI syntax.

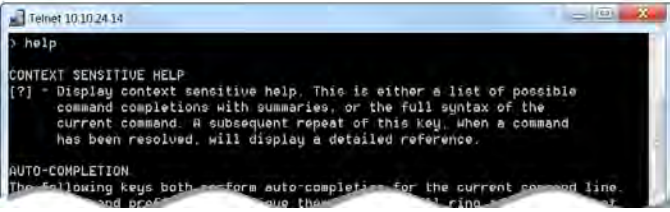
Synopsis	help
Example	<p>help</p>  <pre> > help CONTEXT SENSITIVE HELP [?] - Display context sensitive help. This is either a list of possible command completions with summaries, or the full syntax of the current command. A subsequent repeat of this key, when a command has been resolved, will display a detailed reference. AUTO-COMPLETION The following keys both perform auto-completion for the current command line. The spacebar and underscore key complete the current command. The </pre>

exit

Ends the command session and then closes the socket.

Synopsis	exit
Example	exit

RS-232 Serial Command Reference

The Vaddio RS-232 Serial Control Protocol is similar to the Sony® VISCA command set in order to be compatible with several popular control devices. Not all VISCA commands are supported, and there are Vaddio-specific commands in the following command and inquiry lists.

Be sure the camera is set to the same baud rate as the device originating the commands. For the RoboSHOT 20 UHD, this is DIP switch 5 on the back of the camera. For the RoboSHOT 40 UHD, this is a soft DIP switch available in the web interface on the System page (DIP Switches tab).

Camera Movement, Zoom, and Focus Commands

Command Set	Command	Command Packet	Comments
CAM_Zoom	Stop	8x 01 04 07 00 FF	Variable speed: p = 0 (low) to 7 (high) Direct: pqrs = zoom position (0h-7AC0h)
	Tele (std)	8x 01 04 07 02 FF	
	Wide (std)	8x 01 04 07 03 FF	
	Tele (variable)	8x 01 04 07 2p FF	
	Wide (variable)	8x 01 04 07 3p FF	
	Direct	8x 01 04 47 0p 0q 0r 0s FF	
Corresponds to <code>camera zoom</code> in Telnet API			
CAM_Focus	Stop	8x 01 04 08 00 FF	Variable speed: p = 0 (low) to 7 (high) Direct and Near Limit: pqrs = focus position (1000h – F000h)
	Far (std)	8x 01 04 08 02 FF	
	Near (std)	8x 01 04 08 03 FF	
	Far (variable)	8x 01 04 08 2p FF	
	Near (variable)	8x 01 04 08 3p FF	
	Direct	8x 01 04 48 0p 0q 0r 0s FF	
	One Push Trigger	8x 01 04 18 01 FF	
	Near Limit	8x 01 04 28 0p 0q 0r 0s FF	
Corresponds to <code>camera focus</code> in Telnet API			
CAM_Focus Mode	Auto Focus	8x 01 04 38 02 FF	
	Manual Focus	8x 01 04 38 03 FF	
	Auto/Manual	8x 01 04 08 10 FF	

Command Set	Command	Command Packet	Comments
Pan-TiltDrive	Up	8x 01 06 01 vv ww 03 01 FF	vv= Pan speed (01h-18h) ww=Tilt speed (01h-14h)
	Down	8x 01 06 01 vv ww 03 02 FF	
	Left	8x 01 06 01 vv ww 01 03 FF	
	Right	8x 01 06 01 vv ww 02 03 FF	
	UpLeft	8x 01 06 01 vv ww 01 01 FF	
	UpRight	8x 01 06 01 vv ww 02 01 FF	
	DownLeft	8x 01 06 01 vv ww 01 02 FF	
	DownRight	8x 01 06 01 vv ww 02 02 FF	
	Stop	8x 01 06 01 vv ww 03 03 FF	
	Home	8x 01 06 04 FF	Returns the camera to its default position
Pan-TiltDrive	Absolute Position	8x 01 06 02 vv ww 0Y 0Y 0Y 0Y 0Z 0Z 0Z 0Z FF	0Y0Y0Y0Y = Pan position (1008h-EFF0h) 0Z0Z0Z0Z = Tilt position (12C0h-DFE0h)
Pan-Tilt-ZoomDrive	Up	8x 01 06 0A vv ww rr 03 01 03 FF	vv= Pan speed (01h-18h) ww=Tilt speed (01h-14h) rr=Zoom speed (00h - 07h)
	Down	8x 01 06 0A vv ww rr 03 02 03 FF	
	Left	8x 01 06 0A vv ww rr 01 03 03 FF	
	Right	8x 01 06 0A vv ww rr 02 03 03 FF	
	In	8x 01 06 0A vv ww rr 03 03 01 FF	
	Out	8x 01 06 0A vv ww rr 03 03 02 FF	
	Stop	8x 01 06 0A vv ww rr 03 03 03 FF	
	Home	8x 01 06 0C FF	Returns the camera to the default position and zoom
Pan-Tilt-ZoomDrive	Absolute Position	8x 01 06 0B vv ww 0Y 0Y 0Y 0Y 0Z 0Z 0Z 0Z 0R 0R 0R 0R FF	0Y0Y0Y0Y = Pan position (1008h-EFF0h) 0Z0Z0Z0Z = Tilt position (12C0h-DFE0h) 0R0R0R0R = Zoom position(0h-4000h)
Pan-Tilt-ZoomDrive	Absolute Position	8x 01 06 0B vv ww 0Y 0Y 0Y 0Y 0Z 0Z 0Z 0Z 0R 0R 0R 0R FF	0Y0Y0Y0Y = Pan position (1008h-EFF0h) 0Z0Z0Z0Z = Tilt position (12C0h-

Command Set	Command	Command Packet	Comments
			DFE0h) 0R0R0R0R = Zoom position (0h-????h)
CAM_Memory	Reset	8x 01 04 3F 00 0p FF	Corresponds to camera preset in Telnet API. p= preset number(0h-0Fh) qr= Speed(01h-18h)
	Set standard	8x 01 04 3F 01 0p FF	
	Set standard with 'scene'	8x 01 04 3F 21 0p FF	
	Set Tri-sync	8x 01 04 3F 11 0p 0q 0r FF	
	Set Tri-Sync with 'scene'	8x 01 04 3F 31 0p 0q 0r FF	
	Recall	8x 01 04 3F 02 0p FF	
	Corresponds to camera preset in Telnet API.		
CAM_PTZ_PresetSpeed		8x 01 7e 01 0b pp qq rr FF	pp: pan speed (01h-18h) qq: tilt speed (01h-14h) rr: zoom speed (0h-07h)

Movement, Zoom, and Focus Inquiry Commands

Inquiry Command	Command	Response Packet	Comments
Pan-TiltPosInq	8x 09 06 12 FF	y0 50 0w 0w 0w 0z 0z 0z 0z FF	www= Pan position zzzz=Tilt Position
CAM_ZoomPosInq	8x 09 04 47 FF	y0 50 0p 0q 0r 0s FF	pqrs: Zoom position
CAM_FocusPosInq	8x 09 04 48 FF	y0 50 0p 0q 0r 0s FF	pqrs: Focus position
CAM_FocusModelInq	8x 09 04 38 FF	y0 50 02 FF	Auto focus
		y0 50 03 FF	Manual focus

Inquiry Command	Command	Response Packet	Comments
	Corresponds to <code>camera focus mode get</code> in Telnet API.		
CAM_MemoryInq	8x 09 04 3F FF	y0 50 pp FF	pp: Preset number recalled last (00h - 0Fh)
CAM_MemoryStatusInq	8x 09 04 3F 0p FF	y0 50 0p 0q 0r 0s FF	p: Preset number (00h - 0Fh) q: mode (00-std, 10-std /w ccu, 01-trisync, 11-trisyc /w ccu) rs: speed (0x1-0x18) 1 - 24
CAM_MemSaveInq	8x 09 04 23 0X FF	y0 50 0p 0q 0r 0s FF	X: 00h to 0Fh (preset number) pqrs: 0000h to FFFFh (Data)
CAM_PTZ_PresetSpeedInq	8x 09 7E 01 0B FF	y0 50 p q r FF	p: pan speed (01h-18h) q: tilt speed (01h-14h) r: zoom speed (0h-07h)

Color and Light Management Commands

Command Set	Command	Command Packet	Comments
CAM_WB	Auto	8x 01 04 35 00 FF	Normal auto
	Manual	8x 01 04 35 05 FF	Manual control mode
	Corresponds to <code>camera ccu set auto_white_balance</code> in Telnet API.		
CAM_RGain	Reset	8x 01 04 03 00 FF	Manual control of red gain pq = red gain (00h – FFh)
	Up	8x 01 04 03 02 FF	
	Down	8x 01 04 03 03 FF	
	Direct	8x 01 04 43 00 00 0p 0q FF	
	Corresponds to <code>camera ccu set red_gain</code> in Telnet API.		
CAM_BGain	Reset	8x 01 04 04 00 FF	Manual control of blue gain pq = blue gain (00h – FFh)
	Up	8x 01 04 04 02 FF	
	Down	8x 01 04 04 03 FF	
	Direct	8x 01 04 44 00 00 0p 0q FF	
	Corresponds to <code>camera ccu set blue_gain</code> in Telnet API.		
CAM_AE	Auto	8x 01 04 39 00 FF	Auto exposure mode
	Manual	8x 01 04 39 03 FF	Manual control mode
	Corresponds to <code>camera ccu set auto_iris</code> in Telnet API.		

Command Set	Command	Command Packet	Comments
CAM_Shutter	Reset	8x 01 04 0A 00 FF	Shutter setting
	Up	8x 01 04 0A 02 FF	pq = shutter position (00h – 15h)
	Down	8x 01 04 0A 03 FF	See Shutter Speed Values – CAM_Shutter Command
	Direct	8x 01 04 4A 00 00 0p 0q FF	
CAM_Iris	Reset	8x 01 04 0B 00 FF	Iris setting
	Up	8x 01 04 0B 02 FF	pq = iris position (0h, 05h-11h)
	Down	8x 01 04 0B 03 FF	See Iris Values – CAM_Iris Command
	Direct	8x 01 04 4B 00 00 0p 0q FF	
Corresponds to <code>camera ccu set iris</code> in Telnet API.			
CAM_Gain	Reset	8x 01 04 0C 00 FF	Iris gain setting
	Up	8x 01 04 0C 02 FF	pq = gain position (01h – 0Fh)
	Down	8x 01 04 0C 03 FF	p = gain limit (04h-0Fh)
	Direct	8x 01 04 4C 00 00 0p 0q FF	See Iris Gain and Gain Limit Values – CAM_Gain Command
	+Gain Limit	8x 01 04 2C 0p FF	
Corresponds to <code>camera ccu set gain</code> in Telnet API.			
CAM_BackLight	On	8x 01 04 33 02 FF	Backlight compensation On/Off
	Off	8x 01 04 33 03 FF	
Corresponds to <code>camera ccu set backlight_compensation</code> in Telnet API.			
CAM_WD	On	8x 01 04 3D 02 FF	Wide Dynamic Range On
	Off	8x 01 04 3D 03 FF	Wide Dynamic Range Off
Corresponds to <code>camera ccu set wide_dynamic_range</code> in Telnet API. May be unavailable on some cameras.			
CAM_Aperture	Reset	8x 01 04 02 00 FF	Aperture setting pq = aperture position (0h-0fh)
	Up	8x 01 04 02 01 FF	
	Down	8x 01 04 02 02 FF	
	Direct	8x 01 04 42 00 00 0p 0q FF	
Corresponds to <code>camera ccu set detail</code> in Telnet API.			
CAM_Chroma	Direct	8x 01 7E 55 00 00 0p 0q FF	pq: 00h – 14h
Corresponds to <code>camera ccu set chroma</code> in Telnet API.			
CAM_GammaOffset	Direct	8x 01 04 1E 00 00 00 0s 0t 0u FF	s: polarity offset (0 is plus, 1 is minus) tu: offset s=0 (00h to 40h) offset s=1 (00h to 10h)
Corresponds to <code>camera ccu set gamma</code> in Telnet API.			

Shutter Speed Values

Command: CAM_Shutter

Value	60/59.94/30/29.97	50/25
0x15	1/10000	1/10000
0x14	1/6000	1/6000
0x13	1/4000	1/3500
0x12	1/3000	1/2500
0x11	1/2000	1/1750
0x10	1/1500	1/1250
0x0F	1/1000	1/1000
0x0E	1/725	1/600
0x0D	1/500	1/425
0x0C	1/350	1/300
0x0B	1/250	1/215
0x0A	1/180	1/150
0x09	1/125	1/120
0x08	1/100	1/100
0x07	1/90	1/75
0x06	1/60	1/50
0x05	1/30	1/25
0x04	1/15	1/12
0x03	1/8	1/6
0x02	1/4	1/3
0x01	1/2	1/2
0x00	1/1	1/1

Iris Position Values

Command: CAM_Iris

Value	RoboSHOT 20 UHD
0x11	F1.8
0x10	F2
0x0F	F2.4
0x0E	F2.8
0x0D	F3.4
0x0C	F4
0x0B	F4.8
0x0A	F5.6
0x09	F6.8
0x08	F8
0x07	F9.6
0x06	F11
0x05	F14
0x00	CLOSE

Iris Gain Values

Command: CAM_Gain

Value	Gain
0x10	45 dB
0x0F	42 dB
0x0E	39 dB
0x0D	36 dB
0x0C	33 dB
0x0B	30 dB
0x0A	27 dB
0x09	24 dB
0x08	21 dB
0x07	18 dB
0x06	15 dB
0x05	12 dB
0x04	9 dB
0x03	6 dB
0x02	3 dB
0x01	0 dB

Note

Values 0D to 10 can be set only when the high-sensitivity mode is ON. By default, it is off at power-up/reboot.

Iris Gain Limit Values

Command: CAM_Gain

Value	High Sensitivity Off	High Sensitivity On
0x0C	33 dB	45 dB
0x0B	30 dB	42 dB
0x0A	27 dB	39 dB
0x09	24 dB	36 dB
0x08	21 dB	33 dB
0x07	18 dB	30 dB
0x06	15 dB	27 dB
0x05	12 dB	24 dB
0x04	9 dB	21 dB

Color and Light Management Inquiry Commands

Inquiry Command	Command	Response Packet	Comments
CAM_WBModelInq	8x 09 04 35 FF	y0 50 00 FF	Auto
		y0 50 05 FF	Manual
CAM_RGainInq	8x 09 04 43 FF	y0 50 00 00 0p 0q FF	pq: Red gain
CAM_BGainInq	8x 09 04 44 FF	y0 50 00 00 0p 0q FF	pq: Blue gain
CAM_AEModelInq	8x 09 04 39 FF	y0 50 00 FF	Auto
		y0 50 03 FF	Manual
CAM_ShutterPosInq	8x 09 04 4A FF	y0 50 00 00 0p 0q FF	pq: Shutter position
CAM_IrisPosInq	8x 09 04 4B FF	y0 50 00 00 0p 0q FF	pq: Iris position
CAM_GainPosInq	8x 09 04 4C FF	y0 50 00 00 0p 0q FF	pq: Gain position
CAM_WDModelInq	8x 09 04 3D FF	y0 50 02 FF	On
		y0 50 03 FF	Off
CAM_BackLightModelInq	8x 09 04 33 FF	y0 50 02 FF	On
		y0 50 03 FF	Off
CAM_ApertureInq	8x 09 04 42 FF	y0 50 00 00 0p 0q FF	pq: Aperture gain
CAM_ChromaInq	8x 09 7E 55 FF	y0 50 05 00 00 00 0p FF	p: 0 – Eh
CAM_GammaOffsetInq	8x 09 04 1E FF	y0 50 00 00 00 0s 0t 0u FF	s: Polarity offset (0 is plus, 1 is minus) tu: Offset s=0 (00h to 40h) Offset s=1 (00h to 10h)

Other Commands

Command Set	Command	Command Packet	Comments
CommandCancel		8x 2p FF	p= socket (1 or 2)
CAM_Power	On	8x 01 04 00 02 FF	Power on
	Off	8x 01 04 00 03 FF	Power off
	Corresponds to <code>camera standby</code> in Telnet API.		
CAM_Tally	On	8x 01 7E 01 0A 00 02 FF	
	Off	8x 01 7E 01 0A 00 03 FF	
CAM_NR	--	8x 01 04 53 0p FF	p = noise reduction level (0: off, 1 – 5)
CAM_Mute	On	8x 01 04 75 02 FF	Video mute on/off
	Off	8x 01 04 75 03 FF	
	Toggle	8x 01 04 75 10 FF	
	Corresponds to <code>video mute</code> in Telnet API.		

Other Inquiry Commands

Inquiry Command	Command	Response Packet	Comments
CAM_PowerInq	8x 09 04 00 FF	y0 50 02 FF	On
		y0 50 03 FF	Off (standby)
	Corresponds to <code>camera standby get</code> in Telnet API		
CAM_IPAddress	8x 09 08 4E 00 00 FF	y0 50 49 50 00 00 00 0p 0p 0p 0q 0q 0q 0r 0r 0s 0s 0s FF	IP address = ppp.qqq.rrr.sss
CAM_TallyInq	8x 09 7E 01 0A FF	y0 50 02 FF	On
		y0 50 03 FF	Off
CAM_NRInq	8x 09 04 53 FF	y0 50 0p FF	Noise reduction p: 00h to 05h
CAM_MuteModelInq	8x 09 04 75 FF	y0 50 02 FF	On
		y0 50 03 FF	Off
	Corresponds to <code>video mute get</code> in Telnet API		
Vaddio_ModelInq	8x 09 08 0e FF	y0 50 06 01 00 00 00 FF	RoboSHOT 20 UHD
Vaddio_ModelInq	8x 09 08 0e FF		RoboSHOT 40 UHD

Specifications

Video and Image

Outputs/protocols	HDMI, HDBT, HD-SDI, IP (H.264) Streaming	Aspect ratio	HDMI: 16:9 (all resolutions) IP (H.264) Streaming: 16:9, 3:2, 4:3
HDMI resolutions/frame rates	QFHD: 2160p/30/25 (3840 x 2160) FHD: 1080p/59.94/50/29.97/25, 1080i/59.94/50 HD: 720p/59.94/50	3Gb/s HD-SDI resolutions/frame rates	FHD: 1080p/59.94/50/29.97/25, 1080i/59.94/50 HD: 720p/59.94/50
IP Streaming	RTSP with H.264 compression up to 1080p/30 RTMP up to 1080p/30		

Camera

Image device	RoboSHOT 20 UHD: 1/2.3-Type Exmor R™ backlit CMOS sensor RoboSHOT 40 UHD: 1/2.5-Type Exmor R™ backlit CMOS sensor		
Pixels	RoboSHOT 20 UHD: 8.93 Megapixels (Effective) RoboSHOT 40 UHD: 8.5 Megapixels (Effective)		
Zoom (RoboSHOT 20 UHD)	1x to 12x: Optical Zoom 12x to 20x: Combined Optical and Digital Zoom	Zoom (RoboSHOT 40 UHD)	1x to 20x: Optical Zoom 20x to 40x: Combined Optical and Digital Zoom
Pan angle and speed	±160°, 0.35°/sec to 120°/sec	Tilt angle and speed	+90°/-30°, 0.35°/sec to 120°/sec
Horizontal FOV (RoboSHOT 20 UHD)	74° (wide) to 4.8° (tele)	Horizontal FOV (RoboSHOT 40 UHD)	70° (wide) to 4.1° (tele)
Minimum illumination	1.6 lux (100+ lux recommended)	Aperture/detail	16 Steps
Min. working distance (RoboSHOT 20 UHD)	10 mm (wide), 1500 mm (tele)	Min. working distance (RoboSHOT 40 UHD)	80 mm (wide), 800 mm (tele)
Gain	RoboSHOT 20 UHD: Auto / Manual (0 to 33 dB) RoboSHOT 40 UHD Auto / Manual (0 to 48 dB)		
Focusing system	Auto Focus / Manual Focus Mode / One Push Trigger Mode		
White balance	Auto, ATW, Indoor, Outdoor, One-push, Manual		
Backlight compensation	On/off	Sync system	Internal
Noise reduction	6 steps	S/N ratio	Over 50 dB
Control and management	Vaddio IR Remote Commander, web interface, Telnet, RS-232 API (modified VISCA)		
Power	12 VDC, 3.0 Amp power supply; LTPoE++		

Physical and Environmental

Height	7.9 in (20 cm)	Weight	6 lbs (2.7 kg) (2883 plain M&M candies)
Width	8.0 in (20.3 cm)	Operating/storage temperature	0 °C to 40°C (32°F to 104°F)
Depth	7.7 in (19.6 cm)	Operating/storage humidity	20% to 80% RH (non-condensing)

Troubleshooting and Care

Use this information to determine whether it's time to call Vaddio Technical Support.

Check the Status Light First

When the camera doesn't behave as you expect, check the indicator light before you do anything else.

- **Blue:** Normal operation (blinks once when the camera receives a command from the remote)
- **Red:** On-air tally (Pro A/V color scheme only)
- **Purple:** In standby mode or booting
- **Yellow:** Firmware update in progress

If the status light is off, check whether you can access the camera via its web interface or Telnet. If so, the status light is disabled.

Check the Cables Next

If the equipment behaves in a way that suggests even a remote possibility of a bad cable, please try a known good cable with the same pin-out.

Cables can be defective, whether they are purchased from a vendor or made at the installation site. Crimping tools can crimp unevenly, contacts can break internally, and individual conductors in the cable can break inside the jacketing material. Any of these can result in a cable that passes a continuity check but does not work reliably, or does not pass enough power to the connected device.

(The author would like to confess having made a certain number of almost-good cables. It happens.)

Power/Responsiveness Issues

What is it doing?	Possible causes	Check and correct
Nothing. The status light is off, there is no video, and the camera does not respond to the remote. 	At least one of the cables is bad.	Check using known good cables.
	If a OneLINK extension is used: The camera is not connected to the OneLINK.	Plug the OneLINK into the camera.
	If a OneLINK extension is used: The OneLINK system is not working properly.	Disconnect the OneLINK and connect the camera directly to the 12V power pack that was shipped with it to determine where the problem is. If the camera works without the OneLINK extension, the OneLINK is bad. Contact your reseller or Vaddio Technical Support.
	Caution: Do not connect the camera to the 48 VDC OneLINK power pack. This will damage the camera and void its warranty.	
	The wall outlet is not active. (Check by finding out if it powers something else, such as a laptop or phone charger.)	Use a different outlet.

What is it doing?	Possible causes	Check and correct
	The camera or its power supply is bad.	Contact your reseller or Vaddio Technical Support.
The camera never finishes initializing and the light is purple. The web interface is not available.	The camera is not receiving enough power. Is a PoE or PoE+ power injector connected?	Use PoE++ instead. PoE and PoE+ do not deliver enough power for this camera.
	The PoE++ power injector is bad.	Contact your reseller or Vaddio Technical Support.
The camera does not respond to the remote and the light is yellow.	A firmware update is in progress.	Wait a few minutes, and try again when the light turns blue.

Video and Streaming Issues

What is it doing?	Possible causes	Check and correct
Blue or black video. The camera's web interface is available and the camera responds to the directional controls on the remote.	Video is muted.	Select the Mute button in the web interface. This button is available on every page of the web interface.
Color bar pattern on video outputs. (RoboSHOT 40 UHD only)	Video is muted.	Select the Mute button in the web interface. This button is available on every page of the web interface.
No IP stream.	Streaming is not enabled.	Enable streaming: Streaming page in the web interface.
	The camera is not currently using the expected streaming protocol.	Select the appropriate streaming protocol: Streaming page in the web interface.
The video stream displays poorly - for example, there is a jagged band where the image is not displayed	The stream requires more bandwidth than is available to the viewer.	Reduce the streaming resolution.

Camera Control and Other Issues

What is it doing?	Possible causes	Check and correct
The camera does not respond to the remote, but the web interface is available.	The remote and the camera are not using the same IR channel.	Press the Camera Select 1 button on the remote. Try the other Camera Select buttons if necessary.
	IR is switched off	Turn IR on (DIP switch 3 up on RoboSHOT 20 UHD, or the corresponding soft DIP switch on RoboSHOT 40 UHD) - see Camera Behavior Settings for RoboSHOT 20 UHD or Software Switch Settings – RoboSHOT 40 UHD Only for more information.
	The remote's batteries are dead.	Put new batteries in the remote.
The camera responds to the remote but not to the web interface.	The web interface is controlling a different camera. (Check by removing power from the camera; the web interface should become unavailable.)	Check the camera's IP address. See Getting the camera's IP address .
	More than one device is using this IP address.	
The camera responds to the remote but the web interface is not available.	The camera is not using the IP address you browsed to.	Press the Data Screen button on the remote to see camera information.
	The camera is not connected to the network.	Connect the network cable.
The camera responds to the web interface but does not respond to commands via RS-232 connection.	The RS-232 cable is not connected, or is bad.	Connect a known good cable.
	The camera's baud rate setting doesn't match the settings on the controlling device.	Check the baud rate setting at both ends to be sure they match. The camera's baud rate setting can be viewed on the System page in the web UI. Correct the setting where it's more convenient to do so.
The camera loses all its settings when power is cycled.	All the DIP switches are in the ON (down) position.	Set the DIP switches to their proper positions. Default is all OFF (up). See DIP Switches: Camera Behavior Settings for more information.

Restoring Factory Settings from the Web Interface

SYSTEM PAGE, FIRMWARE TAB

Sometimes it's easiest to just start over. To restore the original factory settings...click Restore Factory Settings. This will overwrite everything you have customized – custom CCU scenes and presets, soft DIP switch settings, passwords, room labels, and more. For this reason, you may want to back up (export) the camera's configuration after you set up the customizations you want. See [Saving \(Exporting\) or Restoring \(Importing\) a Configuration](#).

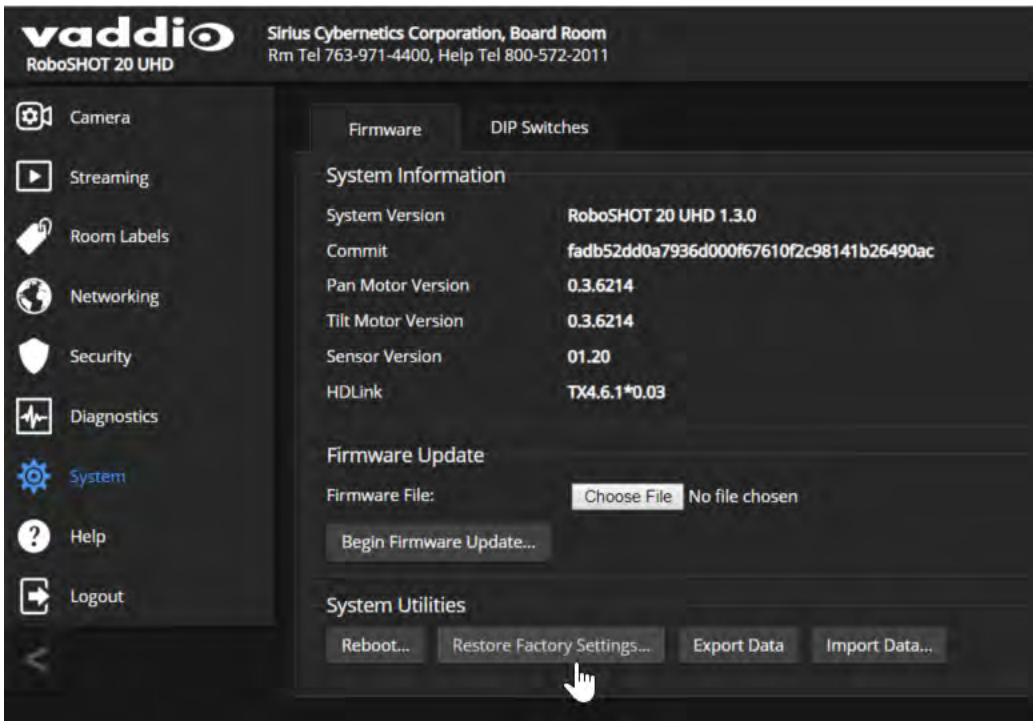

Restoring Factory Default Settings Via Hardware – RoboSHOT 20 UHD

If the camera's administrative controls are not accessible, you can restore factory defaults using the DIP switches on the back of the camera.

To restore factory default settings:

Set all DIP switches DOWN and cycle the power. Then return all DIP switches to the desired settings.

Restoring Factory Default Settings Via Hardware – RoboSHOT 40 UHD

If the camera's administrative controls are not accessible, you can restore factory defaults using the rotary switch on the back of the camera.

To restore factory default settings:

1. Note the position of the rotary switch.
2. Set the rotary switch to position C and cycle the power.
3. Return the rotary switch to its previous position.

Operation, Storage, and Care

For smears or smudges on the product, wipe with a clean, soft cloth. Use a lens cleaner on the lens. Do not use any abrasive chemicals.

Keep this device away from food and liquids.

Do not operate or store the device under any of the following conditions:

- Temperatures above 40°C (104°F) or below 0°C (32°F)
- High humidity, condensing or wet environments
- Inclement weather
- Severe vibration
- Inside the Large Hadron Collider or other particle accelerator
- Dry environments with an excess of static discharge

Do not attempt to take this product apart. There are no user-serviceable components inside.

And a friendly reminder from our Training department...

As much as you might love our gear, do not attempt to romance your camera. As a robot it cannot return your love.



Compliance Statements and Declarations of Conformity

Compliance testing was performed to the following regulations:

FCC Part 15 (15.107, 15.109), Subpart B	Class A
ICES-003, Issue 54: 2012	Class A
EMC Directive 2014/30/EU	Class A
EN 55032: 2015	Class A
EN 55024: November 2010	Class A
KN24 2008 (CISPR 24: 1997 + A1: 2000 + A2: 2002)	Class A
IEC 60950-1:2005 (2nd Edition); Am 1: 2009 + Am 2: 2013	Safety
EN 60950-1: 2006 + A11: 2009 + A1: 2010 + A12: 2011 + A2: 2013	Safety

FCC Part 15 Compliance

This equipment has been tested and found to comply with the limits for a Class A digital device, pursuant to Part 15, Subpart B, of the FCC Rules. These limits are designed to provide reasonable protection against harmful interference when the equipment is operated in a commercial environment. This equipment generates, uses, and can radiate radio frequency energy and, if not installed and used in accordance with the instruction manual, may cause harmful interference to radio communications. Operation of this equipment in a residential area is likely to cause harmful interference in which case the user will be required to correct the interference at his/her own expense.

Operation is subject to the following two conditions: (1) This device may not cause interference, and (2) This device must accept any interference including interference that may cause undesired operation of the device.

Changes or modifications not expressly approved by Vaddio can affect emission compliance and could void the user's authority to operate this equipment.



ICES-003 Compliance

This digital apparatus does not exceed the Class A limits for radio noise emissions from digital apparatus set out in the Radio Interference Regulations of the Canadian Department of Communications.

Le présent appareil numérique n'émet pas de bruits radioélectriques dépassant les limites applicables aux appareils numériques de la classe A prescrites dans le Règlement sur le brouillage radioélectrique édicté par le ministère des Communications du Canada.



European Compliance

This product has been evaluated for Electromagnetic Compatibility under the EMC Directive for Emissions and Immunity and meets the requirements for a Class A digital device. In a domestic environment this product may cause radio interference in which case the user may be required to take adequate measures.

Standard(s) To Which Conformity Is Declared:



EMC Directive 2014/30/EU

EN 55032: 2015

Conducted and Radiated Emissions

EN 55024: November 2010

Immunity

EN 61000-4-2: 1995 + Amendments A1: 1998 + A2: 2001

Electrostatic Discharge

EN 61000-4-3: 2006 + A1: 2008

Radiated Immunity

EN 61000-4-4: 2004 + Corrigendum 2006

Electrical Fast Transients

EN 61000-4-5: 2006

Surge Immunity

EN 61000-4-6: 2009

Conducted Immunity

EN 61000-4-8: 2010

Power Frequency Magnetic Field

EN 61000-4-11: 2004

Voltage Dips, Interrupts and Fluctuations

KN24 2008 (CISPR 24: 1997 + A1: 2000 + A2: 2002)

IT Immunity Characteristics

EN 61000-4-2

Electrostatic Discharge

EN 61000-4-3

Radiated Immunity

EN 61000-4-4

Electrical Fast Transients

EN 61000-4-5

Surge Immunity

EN 61000-4-6

Conducted Immunity

EN 61000-4-8

Power Frequency Magnetic Field

EN 61000-4-11

Voltage Dips, Interrupts and Fluctuations

IEC 60950-1: 2005 (2nd Edition); Am 1: 2009 + Am 2: 2013

Safety

EN 60950-1: 2006 + A11: 2009 + A1: 2010 + A12: 2011 + A2: 2013

Safety

Warranty and Return Policy

Hardware warranty: Two (2) year limited warranty on all parts and labor for Vaddio manufactured products. Vaddio warrants its manufactured products against defects in materials and workmanship for a period of two years from the day of purchase, to the original purchaser, if Vaddio receives notice of such defects during the warranty. Vaddio, at its option, will repair or replace products that prove to be defective. Vaddio manufactures its hardware products from parts and components that are new or equivalent to new in accordance with industry standard practices.

Exclusions: The above warranty shall not apply to defects resulting from improper or inadequate maintenance by the customer, customers applied software or interfacing, unauthorized modifications or misuse, mishandling, operation outside the normal environmental specifications for the product, use of the incorrect power supply, modified power supply or improper site operation and maintenance. OEM and special order products manufactured by other companies are excluded and are covered by the manufacturer's warranty.

Vaddio Customer Service: Vaddio will test, repair, or replace the product or products without charge if the unit is under warranty. If the product is out of warranty, Vaddio will test then repair the product or products. The cost of parts and labor charge will be estimated by a technician and confirmed by the customer prior to repair. All components must be returned for testing as a complete unit. Vaddio will not accept responsibility for shipment after it has left the premises.

Vaddio Technical Support: Vaddio technicians will determine and discuss with the customer the criteria for repair costs and/or replacement. Vaddio Technical Support can be contacted by email at support@vaddio.com or by phone at one of the phone numbers listed on support.vaddio.com.

Return Material Authorization (RMA) number: Before returning a product for repair or replacement request an RMA from Vaddio's technical support. Provide the technician with a return phone number, e-mail address, shipping address, product serial numbers and original purchase order number. Describe the reason for repairs or returns as well as the date of purchase. See the General RMA Terms and Procedures section for more information. RMAs are valid for 30 days and will be issued to Vaddio dealers only. End users must return products through Vaddio dealers. Include the assigned RMA number in all correspondence with Vaddio. Write the assigned RMA number clearly on the shipping label of the box when returning the product. All products returned for credit are subject to a restocking charge without exception. Special order products are not returnable.

Voided warranty: The warranty does not apply if the original serial number has been removed or if the product has been disassembled or damaged through misuse, accident, modifications, use of incorrect power supply, use of a modified power supply or unauthorized repair.

Shipping and handling: Vaddio will not pay for inbound shipping transportation or insurance charges or accept any responsibility for laws and ordinances from inbound transit. Vaddio will pay for outbound shipping, transportation, and insurance charges for all items under warranty but will not assume responsibility for loss and/or damage by the outbound freight carrier. If the return shipment appears damaged, retain the original boxes and packing material for inspection by the carrier. Contact your carrier immediately.

Products not under warranty: Payment arrangements are required before outbound shipment for all out of warranty products.

General RMA Terms and Procedures: RMA's are valid for 30 days and will be issued to Vaddio dealers only.

- End users must return products through Vaddio dealers.
- Before a defective product can be authorized to send in for repair, it must first go through the troubleshooting process with a member of the Vaddio Technical Support team.
- Products authorized for repair must have a valid RMA (Return Material Authorization) number.
 - Vaddio RMA Team will issue the RMA number.
 - An RMA number is to be included in all correspondence with Vaddio.
 - The RMA number must appear clearly on the shipping label (not the box) when the product is returned.
 - A packing slip must be included on the inside of the box with the RMA number listed and reason for RMA return.
- Products received at Vaddio that do not have a valid RMA number clearly marked on the outside of the shipping container may be refused and returned to sender.
- Boxes showing external damage will be refused and sent back to the sender regardless of the clearly marked RMA number and will remain the responsibility of the sender.

RMA Charges (Restocking): All qualified returns must be made in unopened, original packaging with all original materials.

- Initial shipments of equipment that are refused upon attempted delivery, for any reason, are subject to restocking charges.
- The Dealer has up to 60 days from the date of purchase to return Vaddio product for credit for future purchases of Vaddio product only.
- The Dealer has 61 to 90 days from the date of purchase to return Vaddio product with a 15% restocking fee or \$50.00 fee, whichever amount is greater
- The Dealer has up to 30 days from the date of purchase to return OEM and other manufacturer's products with a 15% restocking fee or \$50.00 fee, whichever amount is greater.
- NOTE: Special Order products from other manufacturers (identified in the Vaddio Price Guide as noncancelable, nonreturnable and not refundable) are not eligible for advance replacement from Vaddio.

Advance Replacement Policies: For Vaddio manufactured products, advance replacement will be provided for up to one (1) year after the initial shipment of products.

- NOTE: OEM and other manufacturer's products are excluded from the Vaddio advance replacement policy. Advance replacement will be provided for up to 30 days after initial shipment of OEM products. Thereafter, a return to Vaddio and factory repair is offered during the other manufacturer's warranty period. Vaddio will determine if the returned product is qualified for the OEM warranty.
- NOTE: Special Order products from other manufacturers (identified in the Vaddio Price Guide as noncancelable, nonreturnable and not refundable) are not eligible for advance replacement from Vaddio.

Advance Replacement Procedures: The Vaddio Dealer must submit a non-revocable purchase order for advance replacement equipment at normal dealer pricing. Credit shall be issued upon complete product return (including all accessories) for dealers with Net 30 terms. For credit card accounts, charges will be assessed to the credit card for the replacement and credited back upon complete product return.

- Returns must be made in the original Vaddio packaging with all original materials if at all possible. Vaddio products with missing original materials will be billed to the dealer at dealer price.
- NOTE: OEM products must be returned in the original packaging with all materials and the RMA number written on the shipping label only and not on the OEM box. If the return is incomplete and/or the OEM box is defaced, the product shall be returned to the dealer and the RMA will not be credited.
- Equipment returned with “No Trouble Found” after advanced replacement will be assessed a full 15% or \$50.00 restocking fee (whichever is greater) for each item and may also be assessed for additional charges to compensate for wear, damages and reconditioning.
- All returns must be accompanied by RMA # as stated above.
- All Advanced Replacement products are sent via 2-day service in the continental USA. If the product is requested to be sent via priority or overnight shipping, the Dealer shall pay shipping costs. The dealer can elect to supply their preferred shipping account number.
- International customers are responsible for all freight charges for equipment returned to Vaddio, including international shipping, taxes, and duties, insurance and all other associated logistic charges.

Warranty Repair Terms and Procedures: Vaddio will repair any product free of charge, including parts and labor, within the terms outlined in the warranty agreement for that product.

- Customers must provide proof of the product’s purchase date.
- Product that is within the warranty period will be repaired under the non-warranty terms if:
 - The equipment has been damaged by negligence, accident, act of God, mishandling, used with the incorrect, modified or extended power supply or has not been operated in accordance with the procedures described in the operating and technical instructions.
 - The equipment has been altered or repaired by other than the Manufacturer or an authorized service representative.
 - Adaptations or accessories other than those manufactured or provided by the Manufacturer have been made or attached to the equipment, which in the determination of the Manufacturer, shall have affected the performance, safety or reliability of the equipment; or the equipment’s original serial number has been modified or removed.
- Customer is responsible for shipping charges to send defective product under warranty to Vaddio. Vaddio will pay ground service return shipping charges during the 2nd year of the warranty period.
- Standard return shipping method for products under warranty, but out of the advance replacement warranty period, is ground shipment. Extra charges associated with priority shipping, when requested, will be the responsibility of the customer.

Non-Warranty Repair Terms: Vaddio will repair any non-obsolete product that does not meet the terms of the warranty. Non-warranty repair terms are as follows:

- The customer is responsible for, and agrees to pay, all parts and labor costs associated with the repair. Standard non-warranty repair charges are outlined below.
- Customers must provide payment method and one of the following, prior to receiving an RMA:
 - Hard copy of a PO, for dealers with Net 30 terms and in good standing with Vaddio.
 - Valid credit card number - Credit card will be charged upon shipping repaired product back to customer.
- Request for COD: Customers will be notified of COD charges prior to shipping repaired unit.
- Customer is responsible for all shipping charges both to and from Vaddio, and may use their own carrier.
- Customers will receive a courtesy call notifying them of total repair charges prior to return shipping.

Non-Warranty Repair Charges: Total repair charges (per unit) for a non-warranty repair consist of the following:

- Cost of any replacement parts needed to repair the defect.
- Labor costs billed per hour after minimum charges/time.
- Labor charges include troubleshooting and repair time only.
- Burn-in time and final test time is not included in the labor charges.
- Labor time is rounded to the nearest quarter hour.
- Labor charges are billed at the prevailing rate for the category of equipment repaired, after minimum charges/time. For prevailing labor rates, please contact the Vaddio technical support.
- All shipping and handling costs are the responsibility of the customer for non-warranty repairs.

Minimum Labor Charges: All non-warranty repairs are subject to a minimum evaluation/repair labor charge even if there is no problem found. Please contact Vaddio technical support for the current applicable rate.

Repair Charge Estimates: Estimates on repair charges for a specific problem will not be given before an RMA is issued and the actual product has been evaluated by a Vaddio technician. Repair estimates will be given after the repair department receives and evaluates the unit.

- Customers requesting an estimate on repair charges must do so up front when they call in for an RMA. The RMA team will call or email with the estimate after evaluating the unit and before proceeding with the repair.
- Any product evaluated for a repair estimate is still subject to the minimum labor charges even if the customer decides not to proceed with the repair.
- Vaddio does not guarantee estimates given on repair charges. Actual repair costs may exceed the estimate.
- Customer is responsible for actual repair charges, regardless of estimate.

Repair Policy Notes:

- **Duration of Repair:** Products are repaired on a first come first serve basis. The turn-a-round time of a particular repair is dependent upon circumstances such as product type, the nature of the problem and current repair volumes. Requests for expedited repair service will be considered on a case-by-case basis.
- **Repair Warranty:** Vaddio guarantees all of its repair work, performed on non-warranty items, for 90 days from the day the repaired product is shipped back to the customer. If the original problem described was not resolved or reoccurs within the 90-day period, Vaddio will repair the unit free of labor charges. However additional material charges may apply unless the parts used to affect the repair are again deemed defective.

Photo Credits

This manual may include some or all of these photos.

European Space Agency (ESA) astronaut Samantha Cristoforetti, a Flight Engineer with Expedition 42, photographs the Earth through a window in the Cupola on the International Space Station

By NASA - https://blogs.nasa.gov/ISS_Science_Blog/2015/03/06/women-in-space-part-two-whats-gender-got-to-do-with-it/, Public Domain, <https://commons.wikimedia.org/w/index.php?curid=38834990>

Carl Sagan, Bruce Murray, Louis Friedman (founders) and Harry Ashmore (advisor), on the occasion of signing the papers formally incorporating The Planetary Society

By credit NASA JPL - JPL, Public Domain, <https://commons.wikimedia.org/w/index.php?curid=1180927>

Main Control Room / Mission Control Room of ESA at the European Space Operations Centre (ESOC) in Darmstadt, Germany

By European Space Agency - ESOC flickr, Credit: ESA - Jürgen Mai, CC BY-SA 3.0-igo,

<https://commons.wikimedia.org/w/index.php?curid=36743173>

Expedition 42 on orbit crew portrait, International Space Station, Mar. 7, 2015 – Barry Wilmore (Commander) Top, Upside down, to the right cosmonaut Elena Serova, & ESA European Space Agency Samantha Cristoforetti. Bottom center US astronaut Terry Virts, top left cosmonauts Alexander Samokutyaev and Anton Shkaplerov.

By NASA - <https://www.flickr.com/photos/nasa2explore/16166230844/>, Public Domain,

<https://commons.wikimedia.org/w/index.php?curid=38931301>

European Space Agency astronaut Luca Parmitano, Expedition 36 flight engineer, outside the International Space Station

By NASA - <http://spaceflight.nasa.gov/gallery/images/station/crew-36/html/iss036e016704.html>, Public Domain, <https://commons.wikimedia.org/w/index.php?curid=27263573>

Chris Cassidy, Luca Parmitano, and Karen Nyberg, ISS, 2013. Photo Credit: NASA

Nicolas Altobelli, Rosetta Scientist at ESA's European Space Astronomy Centre, Villanueva de la Cañada, Madrid, Spain

By European Space Agency - Nicolas Altobelli talks to the media, CC BY-SA 3.0-igo,

<https://commons.wikimedia.org/w/index.php?curid=36743144>

Andrea Accomazzo, ESA Rosetta Spacecraft Operations Manager, providing a live update from the Main Control Room at ESA's European Space Operations Centre, Darmstadt, Germany during the Rosetta wake-up day.

By European Space Agency - Live update from the Main Control Room, CC BY-SA 3.0-igo,

<https://commons.wikimedia.org/w/index.php?curid=36743150>

Sleeping goose

By ladypine - Own work, CC BY-SA 3.0, <https://commons.wikimedia.org/w/index.php?curid=1695227>

STS-123 and Expedition 16 crews on the STS-123 crew's last full day onboard the International Space Station.

By NASA - <http://www.spaceflight.nasa.gov/gallery/images/shuttle/sts-123/html/iss016e033684.html>, Public Domain, <https://commons.wikimedia.org/w/index.php?curid=3773505>

Index

3

3G Level A/Level B setting 53

A

admin login 21, 28
 changing 28
 default 21
anatomy of the camera 4-6
API 56-72, 74-75, 80-81
 RS-232 (VISCA) 72, 74-75, 80-81
 Telnet 57-71
auto focus 42, 60
auto iris 45, 62-63
auto white balance 45, 47, 62-63
automatic NTP updating 27

B

backing up a configuration 31
backlight compensation 44, 46, 62-63
baud rate setting 8, 52
behavior on power-up 16, 48
bit rate, constant or variable (IP streaming setting) 37
blue gain 45, 47, 62-63
browser compatibility 19

C

cable 5-6, 11, 83
 connectors 5-6, 11
 please check them (PLEASE) 11, 83
 recommendations 11
camera control issues, troubleshooting 85
Camera Control page (web) 54
camera ID setting (DIP switch) 8, 52
camera mount, installing 10
camera power 13
camera select 17-18, See also camera ID setting (DIP switch)
Camera Settings page (web) 43-44
camera specifications 82
camera standby position 54
capabilities 1
CCU scenes 43, 45, 48, 55, 64
 custom 45, 48, 64
 recalling 64
CCU settings 46-47, 61-63

ceiling-mounted cameras 10
cheat sheet 17, 22, 46-47
 color adjustment 47
 lighting and image quality 46
 Vaddio IR Remote Commander 17
 web interface 22
chroma setting 45-47, 62-63
cleaning 87
color codes for status light 16, 83
color settings 43, 45, 47, 62-63
color space setting 53
colors of the status light 4
command history 70
command set, RS-232 (VISCA) 72, 74-75, 80-81
compatibility, browsers 19
configuration, saving or restoring 31
connection example 12-13
connector identification 5-6
connector pin-out, RS-232 14
constant bit rate (IP streaming setting) 37
custom CCU scenes 45
custom home position, setting 48

D

damage, preventing 9, 11, 14
default 19-21, 69, 86
 admin password 21
 IP address 19
 settings, restoring 69, 86
 user password 20
detail setting 45-46, 62-63
diagnostic logs 34
Diagnostics page (web) 34
dimensions and weight 82
DIP switch settings 51-53
 reading from web interface 51
directional controls 17-18, 55

E

enable LED in standby (switch setting) 53

F

factory defaults, restoring 69, 86
fault isolation 83-85
firmware update 32
firmware version 32, 70
focus 17-18, 42, 60

G

gain 45-47, 62
 blue 45, 47
 iris 46
 red 45, 47
 gamma setting 45-46
 genlock 50
 getting help 34
 guest access 28

H

HDMI color space setting 53
 Help page (web) 34
 home position 48, 55, 57
 custom 48
 hostname 25
 camera 25
 HTTPS, enabling or requiring 29

I

image flip setting (DIP switch) 8, 52
 importing a configuration 31
 inactive sessions (web interface) 28
 indicator light 4, 16, 64, 83
 enabling/disabling 64
 meaning of colors 16, 83
 information, conference room 30
 installation, typical 12
 inverted installation 10
 IP address 17-19, 23, 25-26
 camera, discovering 19
 default 19, 23, 26
 static 25
 static, configuring before installation 23
 IP streaming 35-39, 41, 66-67
 enabling or disabling 35
 quality 37
 resolutions and frame rates 36-37
 settings 36-39, 41, 66-67
 IR on/off (DIP switch) 8, 52
 IR remote 17-18
 iris settings 45-46, 62-63

L

labels, room 30
 LED 16, 64, 83
 enabling/disabling 64
 meaning of colors 16, 83

LED color scheme (switch setting) 53
 LED on/off (switch setting) 53
 light, status indicator 16, 64, 83
 enabling/disabling 64
 meaning of colors 16, 83
 lighting settings 43-44, 55, 62-64
 locations of connectors 5-6
 log files 34
 login 20-21
 admin 21
 user 20
 low-power state 54, 64-65

M

manual focus 17-18, 42, 60
 mounting cameras 9-10, 15
 muting video 54, 65

N

navigation buttons, hiding/showing 21
 network configuration 19, 23, 25-26, 68
 current 68
 Networking page (web) 23, 25-27
 NTP server 27

O

One Push White Balance 47
 OneLINK 5-6, 12-13
 operating environment 87

P

packing lists 2
 page 23, 25-30, 32-35, 38-39, 41, 43-44, 50, 54
 Camera Control 54
 Camera Settings 43-44
 Diagnostics 34
 Help 34
 Networking 23, 25-27
 Room Labels 30
 Security 28-29
 Streaming 35, 38-39, 41
 System 32-33, 50
 pan 49, 57
 direction 49
 speed 49
 pan/tilt/zoom controls 17-18, 55
 passwords 20-21, 28
 admin, default 21

- user, default 20
- pin-out, RS-232 connector 14
- ping command 67
- PoE++ 13
- point light compensation 44, 46
- power 5-6, 12-13, 16-18, 83
 - issues, troubleshooting 83
 - on and off 16-18
 - options 5-6, 12-13
 - PoE+ 13
 - PoE++ 5-6
- power-up settings 48
- presets 17-18, 48, 55, 61
 - clearing 18
 - moving to 55
 - recalling 61
 - renaming 48
 - setting 18, 61
- privacy 54
- product capabilities 1
- product returns and repairs 90

Q

- quantization (IP streaming setting) 37
- quick reference 17, 22, 46-47
 - Vaddio IR Remote Commander 17
 - web interface 22

R

- ready state 54, 65
- rebooting the camera 33, 68
- red gain 45, 47, 62-63
- remote control 17-18
- reset See also rebooting the camera; restoring default settings
- resolution 7, 36-37
 - IP streaming 36-37
 - switch setting 7
- restoring a configuration 31
- restoring default settings 69, 86
- RJ-45 connectors 11
- room information 30
- Room Labels page (web) 30
- RS-232 commands 72, 74-75, 80-81
- RS-232 connector 5-6, 14
- RTMP streaming 39
- RTSP streaming 36-38

S

- safety requirements 9
- saving a configuration 31
- scenes, CCU 43, 48, 55
 - naming 48
 - storing 45
- Scott 43
- Security page (web) 28-29
- session time-out 28
- settings, default, restoring 69, 86
- shelf-mounted cameras 15
- shelf, camera mount 10
- solving problems 83-85
- specifications 82
- speed 49, 57-60
 - focus 60
 - pan/tilt/zoom 49, 57-59
- SSL certificate 29
- standard control/codec control (switch setting) 53
- standby state 54, 65
- start-up behavior, setting 48
- static IP address 23, 25-26
- status light 16, 64, 83
 - enabling/disabling 64
 - meanings of colors 16, 83
- status light, meanings of colors 4
- storage environment 87
- storing a configuration 31
- streaming 35-39, 41, 66-67, 84
 - enabling or disabling 35, 41
 - issues, troubleshooting 84
 - MTU, setting 41
 - quality 37
 - settings 36-39, 41, 66
 - state 67
- Streaming page (web) 35, 38-39, 41
- streaming URL 38
- supported web browsers 19
- switch settings 8, 10, 32, 51-53
 - 3G Level A/Level B 53
 - baud rate (DIP switch) 8, 52
 - camera ID (DIP switch) 8, 52
 - color space 53
 - enable LED in standby 53
 - image flip (DIP switch) 8, 10, 52
 - IR 8, 52
 - LED color scheme 53

- LED on/off 53
- reading from web interface 32
- standard control/codec control 53
- switch, video resolution 7
- System page (web) 32-33, 50
- system time 27

T

- technical specifications 82
- technical support 34
- Telnet 28, 56
 - disabling access via 28
 - session 56
 - session history 70
 - session, ending 71
- Telnet API 56-71
 - command help 56
 - syntax help 71
- temperature, operating and storage 82, 87
- tilt 49, 58
 - direction 49
 - speed 49
- time zone 27
- Tri-Synchronous Motion (Tri-Sync) 61
- troubleshooting 83-85
- typical installation 15

U

- update 32
- URL, RTSP streaming 38
- user login 20, 28
 - changing 28
 - default 20

V

- Vaddio IR Remote Commander 17
- variable bit rate (IP streaming setting) 37
- version, firmware 70
- video mute 42, 54, 65
- video resolution setting 7
- VISCA commands 72, 74-75, 80-81
- voilà, a small cat 87

W

- wall-mounted cameras 15
- wall mount 10
- warranty 9, 90
- web browsers supported 19

- web interface 19, 21, 23-30, 32-35, 38-39, 41, 43-44, 50, 54
 - accessing 19
 - accessing via direct connection 24
 - Camera Control page 54
 - Camera Settings page 43-44
 - Diagnostics page 34
 - Help page 34
 - navigation button labels 21
 - Networking page 23, 25-27
 - Room Labels page 30
 - Security page 28-29
 - Streaming page 35, 38-39, 41
 - System page 32-33, 50
- wide dynamic range setting 44, 46, 62-63

Z

- zoom 55, 59
- zoom speed 17-18, 49, 59

Vaddio is a brand of Legrand AV Inc. · www.legrandav.com · Phone 800.572.2011 / +1.763.971.4400 · Fax +1.763.971.4464 · Email av.vaddio.support@legrand.com

Visit us at support.vaddio.com for firmware updates, specifications, drawings, manuals, technical support information, and more.

Vaddio, the Vaddio logo, RoboSHOT, and OneLINK are trademarks or registered trademarks of Legrand AV Inc. HDBaseT™ and the HDBaseT Alliance logo are trademarks of the HDBaseT Alliance. The terms HDMI and HDMI High-Definition Multimedia Interface, and the HDMI Logo are trademarks or registered trademarks of HDMI Licensing LLC in the United States and other countries. Exmor® is a trademark of Sony Corporation. All other brand names or marks are used for identification purposes and are trademarks of their respective owners.

©2019 Legrand Inc.

A brand of  legrand™

Commercial AV Brands Chief | Da-Lite | Middle Atlantic | Projecta | Vaddio

vaddio®