

SB-5688Kp

8x8 HDMI Matrix Routing Switch w/ Full EDID Management/Learning
UHD 4K2K Capable



IMPORTANT WARRANTY INFORMATION.

If you remove the HDMI screw posts, you must use the provided HDMI Locking Post replacement screws to keep the internal HDMI jack secure. Removing the HDMI screws without installing the HDMI Locking Post replacement screws will void your warranty.



SAFETY INFORMATION



1. To ensure the best results from this product, please read this manual and all other documentation before operating your equipment. Retain all documentation for future reference.
2. Follow all instructions printed on unit chassis for proper operation.
3. To reduce the risk of fire, do not spill water or other liquids into or on the unit, or operate the unit while standing in liquid.
4. Make sure power outlets conform to the power requirements listed on the back of the unit. Keep unit protected from rain, water and excessive moisture.
5. Do not attempt to clean the unit with chemical solvents or aerosol cleaners, as this may damage the unit. Dust with a clean dry cloth.
6. Do not use the unit if the electrical power cord is frayed or broken. The power supply cords should be routed so that they are not likely to be walked on or pinched by items placed upon or against them, paying particular attention to cords and plugs, convenience receptacles, and the point where they exit from the appliance.
7. Do not force switched or external connections in any way. They should all connect easily, without needing to be forced.
8. Always operate the unit with the AC ground wire connected to the electrical system ground. Precautions should be taken so that the means of grounding of a piece of equipment is not defeated.
9. AC voltage must be correct and the same as that printed on the rear of the unit. Damage caused by connection to improper AC voltage is not covered by any warranty.
10. Turn power off and disconnect unit from AC current before making connections.
11. Never hold a power switch in the "ON" position.
12. This unit should be installed in a cool dry place, away from sources of excessive heat, vibration, dust, moisture and cold. Do not use the unit near stoves, heat registers, radiators, or other heat producing devices.
13. Do not block fan intake or exhaust ports. Do not operate equipment on a surface or in an environment which may impede the normal flow of air around the unit, such as a bed, rug, carpet, or completely enclosed rack. If the unit is used in an extremely dusty or smoky environment, the unit should be periodically "blown free" of foreign dust and matter.
14. To reduce the risk of electric shock, do not remove the cover. There are no user serviceable parts inside. Refer all servicing to qualified service personnel. There are no user serviceable parts inside.
15. When moving the unit, disconnect input ports first, then remove the power cable; finally, disconnect the interconnecting cables to other devices.
16. Do not drive the inputs with a signal level greater than that required to drive equipment to full output.
17. The equipment power cord should be unplugged from the outlet when left unused for a long period of time.
18. Save the carton and packing material even if the equipment has arrived in good condition. Should you ever need to ship the unit, use only the original factory packing.
19. Service Information Equipment should be serviced by qualified service personnel when:
 - A. The power supply cord or the plug has been damaged.
 - B. Objects have fallen, or liquid has been spilled into the equipment.
 - C. The equipment has been exposed to rain.
 - D. The equipment does not appear to operate normally, or exhibits a marked change in performance.
 - E. The equipment has been dropped, or the enclosure damaged.

TABLE OF CONTENTS

4K2K HDMI MATRIX SWITCHER SERIES

Thank you for purchasing the SB-5688Kp 4K2K HDMI Matrix Routing Switch. You will find this unit easy to install and highly reliable but it is essential that you read this manual thoroughly before attempting to use 8x8 4K2K HDMI Matrix switcher.

CONTENTS

INTRODUCTION & CONTENTS	1
FEATURES	2
SPECIFICATIONS	3
FRONT PANEL	4
BACK PANEL	8
REMOTE CONTROL	9
EDID FUNCTIONS	11
TYPICAL APPLICATION	15
IR EXTENDER	16
ETHERNET	17
RS-232 PROTOCOL	18

INTRODUCTION

The SB-5688Kp is based on HDMI standards and supports full resolution HDMI video with (7) embedded EDID. High Definition Digital signals can be selected and distributed to any of the (8) Inputs to the (8)+(1) preview outputs. The switcher is certified as being fully CEC and HDCP 1.3 compliant with HDMI 1.4a, 4K2K@30Hz, DVI 1.0, 3D formats and a wide frequency range of 25MHz ~ 340 MHz so there is no signal degradation. Full HD supports UXGA/WUXGA/DVI 1920x1200 resolutions to any HD display. The EDID management can be selected between (7) different modes. Control is provided via front panel push buttons, IR remote, RS- 232 or TCP/IP (not a web-browser). A RS-232 Windows GUI interface is provided for matrix routing control (Windows only).

PACKAGE CONTENTS

- Check that you have the following components;
- SB-5688Kp Matrix Switcher
 - RS-232 V2.0 / Ethernet V1.0 Protocol Instructions
 - IR Remote Control (SW-HD88K)
 - 19 inch Ear mount bracket (Part # 2U-440L)
 - SB-100 IR Extender Receiver Set
 - CD Contents: Manual, Windows GUI, ISP V1.0 Windows driver
 - RS-232 Cable 6.5 feet (2M)
 - HDMI Locking Post Replacement Screws
 - Users Guide
 - Power Supply: Worldwide Universal 100~240 VAC, AC 50/60Hz
 - *Optional: SB-100C IR Extender Receiver Cable (6.5ft (2M))*



SAFETY PRECAUTIONS

Please read all instructions before attempting to unpack, install or operate this equipment and before connecting the power supply. Please keep the following in mind as you unpack and install this equipment:

- Always follow basic safety precautions to reduce the risk of fire, electrical shock and injury to persons.
- To prevent fire or shock hazard, do not expose the unit to rain, moisture or install this product near water.
- Never spill liquid of any kind on or into this product.
- Never push an object of any kind into this product through any openings or empty slots in the unit, as you may damage parts inside the unit.
- Do not attach the power supply cabling to building surfaces.
- Use only the supplied power supply unit (PSU). Do not use the PSU if it is damaged.
- Do not allow anything to rest on the power cabling or allow any weight to be placed upon it or any person walk on it.
- To protect the unit from overheating, do not block any vents or openings in the unit housing that provide ventilation and allow for sufficient space for air to circulate around the unit.

DISCLAIMERS

The information in this manual has been carefully checked and is believed to be accurate. We assume no responsibility for any infringements of patents or other rights of third parties which may result from its use.

We assume no responsibility for any inaccuracies that may be contained in this document. We make no commitment to update or to keep current the information contained in this document.

We reserve the right to make improvements to this document and/or product at any time and without notice.

COPYRIGHT NOTICE

No part of this document may be reproduced, transmitted, transcribed, stored in a retrieval system, or any of its part translated into any language or computer file, in any form or by any means — electronic, mechanical, magnetic, optical, chemical, manual, or otherwise — without express written permission and consent

© Copyright 2017. All Rights Reserved.
Version 1.0 FEB 2017



TRADEMARK ACKNOWLEDGMENTS

All products or service names mentioned in this document may be trademarks of the companies with which they are associated.

FEATURES

FEATURES

- (8) HDMI source devices matrix switched to (8) HDMI+ (1) preview output destinations
- HDMI digital video w/ embedded HDCP and DVI formats and CEC/HDCP 1.3 compliant
- Worldwide control EDID modes for HDMI full 4K2K (24/30Hz) HD video resolutions
- Wide frequency range of 25MHz ~ 340MHz, Support HDMI 4K2K, 1.4a 3D formats
- Wide range of HD resolutions from PC XGA to WUXGA 1920x1200 and HDTV/DTV HDMI resolutions 480i/480p, 576i/576p, 720p, 1080i/p & 4K2K (24/30Hz)
- Compatible with all HDMI source devices, PC monitors, Plasma HD displayd, HDTV and audio receivers or audio amplifiers
- Digital video TMDS formats resolutions up to 4K2K with Deep color 36-bit
- Using the build-in booster, each HDMI Output port is capable of driving cable lengths for 1080p up to 98 feet (30M) & 4K2K up to 66 feet (20M)
- Digital Audio Support: Dolby TrueHD, Dolby Digital, Dolby Digital Plug/ex, DTS, DTS-HD, DTS-HD Master, DTS-EX PCM, PCM2, LPCM2
- Various User Interface Controls:
 - Windows based GUI control via RS-232 interface 2000/XP/WIN7-32/WIN7-64/WIN8
 - Front panel push buttons
 - IR wireless remote control
 - Ethernet switch control
 - Third party RS-232 control (via simple ASCII)
- Supports (7) world wide control function keys:
 - Full function front panel controls: ALL / OFF / EDID / LOCK / RECALL / MEMORY / ENTER
- Supports EDID Modes:
 - a. Embedded EDID Modes: FSS/ H24-3D/ H24-3D-M/ H36-3D/ H36-3D-M/ 4K2K-3D / DVI-D 1920x1200-60Hz
 - b. External Modes: Learning mode-1 (Single Learning) & Learning mode-2 (Multiple Learning)
- Automatic scanning input & output status via LCM show on front panel
- Supports IR Remotes and IR Extenders for distances up to ~984 feet (300M) Maximum
- Supports Universal power adaptor AC100V~AC240V, 50/60Hz

The switcher will remember that last state during a power cycle. When power is removed and resorted, the last configuration will be invoked.

SPECIFICATIONS

SPECIFICATIONS

- **Type of HDMI Switcher:** (8) Inputs to (8) + (1) Preview Outputs HDMI Matrix Switch
- **HDMI Support:** HDMI 4K2K, 1080p@60Hz, H36-bit Deep color, 3D of HDMI V1.4 formats
- **HDCP / CEC Support:** HDCP 1.3 Compliant, CEC Compliant
- **Video Bandwidth:** Wide frequency range 25MHz ~ 340MHz
- **Digital Video Support:** HD: 480i/ 480p/ 720p/ 1080i/p and 4K2K up to 36bit deep color
- **Video Inputs:** (8) HDMI (HDMI or DVI digital source)
- **Video Outputs:**
 - **HDMI:** With Booster output 1080p up to ~98 ft (30M) & 4K2K up to ~66 ft (20M)
 - **Audio Support:** Multi Audio Formats 5.1 / 7.1, MAT (MLP), Dolby Digital, Dolby TrueHD, Dolby Digital Plus, DTS, DTS-ES 6CH, DTS-HD, DTS-HD-HRA, DTS-HD Master, (PCM-2CH)
- **Preview Output:** (1) Preview output (same output #1 picture)
- **Switcher Controls:**
 - Select & Function buttons on front panel (Data status via LCM panel show out)
 - IR Remote Control (switch control)
 - IR External port (switch control via 3.5mm OD Jack)
 - RS-232 series interface (switch control)
 - Ethernet series interface (switch control)
- **Source Status:** Input status LEDs indicates presence of a live signal
- **(23) Function Control Keys:** 1. ALL, 2. OFF, 3. RECALL, 4. ENTER, 5. MEMORY, 6. LOCK, 7. EDID, 8. Destination button 1 thru 8, 9. Source button 1 thru 8
- **(7) EDID Management Modes:**
 - **Select Embedded EDID Modes:** Mode1: FSS, Mode2: H24-3D, Mode3: H24-3D-M, Mode4: H36-3D, Mode5: H36-3D-M, Mode6: 4K2K-3D, PCM-2CH, Mode7: DVI-D 1920x1200-60Hz
 - **Select LEARNING Mode:** Learning Destination EDID to Link Source
- **Infrared Frequency:** 38Khz
- **IR Extend Distance:** ~984 feet / 300M maximum
- **HDMI I/O Connector:** HDMI Type A - SMD 19-pin female type
- **Temperature:** Operating Temperature 32°F - 100°F (0°C - 32°C)
- **Dimensions (LxWxH):** 17.5 x 9.875 x 1.75 in
- **Rack Mount:** 1RU High 19" Rack Mount #1U-440L (with rack mount)
- **Power Supply:** AC 100~240VAC 50/60Hz (120V/0.5A/60W; 220V/0.27A/60W)
- **Safety Approvals:** CE, FCC, RoHS, REACH
- **Weight:** 3.65 Kgs / 8.15 lb

FRONT PANEL

FRONT PANEL

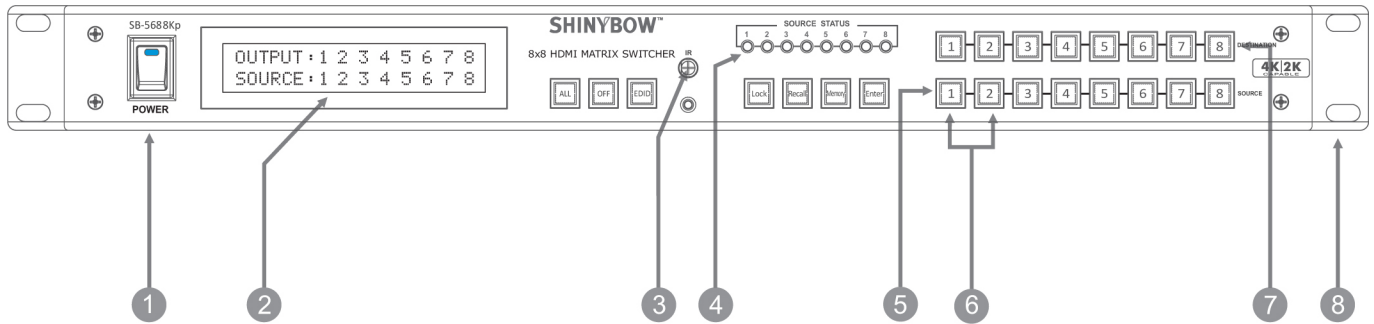

1. POWER SWITCH: The power switch turns the unit on and off. The LCM will illuminate red to indicate that the switcher is ON and is receiving power. The switcher will remember that last state during a power cycle. When power is removed and resorted, the last configuration will be evoked.

2. STATUS DISPLAY: Front panel status display shows current matrix routing configuration. This same display also shows particular configuration settings depending on your current function. In run mode (as shown above), the display shows each Output (destination) channel to which input (source) it is assigned.

3. IR SENSOR: The IR sensor receives IR commands from the supplied remote control or third party IR emitter.

4. INPUT STATUS DISPLAY: Input sources 1 to 8 LED illuminates blue to indicate that a video source is present on that input.

5. SOURCE SELECT BUTTONS: Separate inputs 1 thru 8 select buttons are provided each source selection.

6. EDID MODE SELECT BUTTONS: Used to select EDID mode using Source button #1 or #2.

7. DESTINATION SELECT BUTTONS: Separate outputs 1 thru 8 select buttons are provided for each destination assignment. Routing can be source to destination or one source to multiple destinations.

Example: Press Destination 1, 3, 5, then press Source 2. It will route Input 2 to Output 1, 3, 5 respectfully.

8. 19 INCH EAR MOUNT PAIR: Converts desktop to 19 inch rack mount. Bracket (part # 2U-440L) INCLUDED. Image shows rack mount bracket attached.

FRONT PANEL

FRONT PANEL

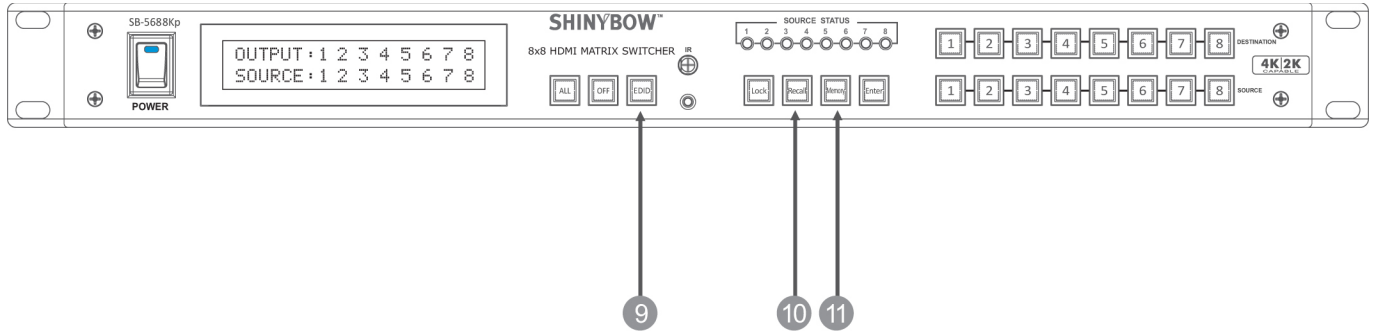

9. FUNCTION KEY - EDID:



Used to display/change current **EDID** mode.

- Press **EDID** to select new EDID mode.
- Press **SOURCE** row #1 or #2 Select EDID modes.
- Press **ENTER** to ready memory location.
- Or press **EDID** again to cancel the operation.

Operation completes.

Note: Operation will abort if no keys are pressed within 5 seconds.

10. FUNCTION KEY - RECALL:



The system will show previously stored presets, up to a total of (16). Presets are stored in local memory using Source keys 1 thru 8 or Destination keys 1 thru 8 as the memory preset location.

- Press **RECALL** button.
- Press **1 THRU 8** on either Source or Destination row.
- Press **ENTER** The pre-set configuration will execute.

Operation completes.

Note: Operation will abort if no keys are pressed within 5 seconds.

- Or press RECALL again to cancel the operation.

11. FUNCTION KEY - MEMORY:



The system will show stored presets, up to a total of (16). Presets are stored in local memory using Source keys 1 thru 8 or Destination keys 1 thru 8 as the memory preset location.

- Configure desired matrices.
- Press **MEMORY** button.
- Press **1 THRU 8** on either Source or Destination row.
- Press **ENTER** to ready memory location.
- Or press **MEMORY** again to cancel the operation.

Operation completes.

Note: Operation will abort if no keys are pressed within 5 seconds.

- Or press MEMORY again to cancel the operation.

FRONT PANEL

FRONT PANEL

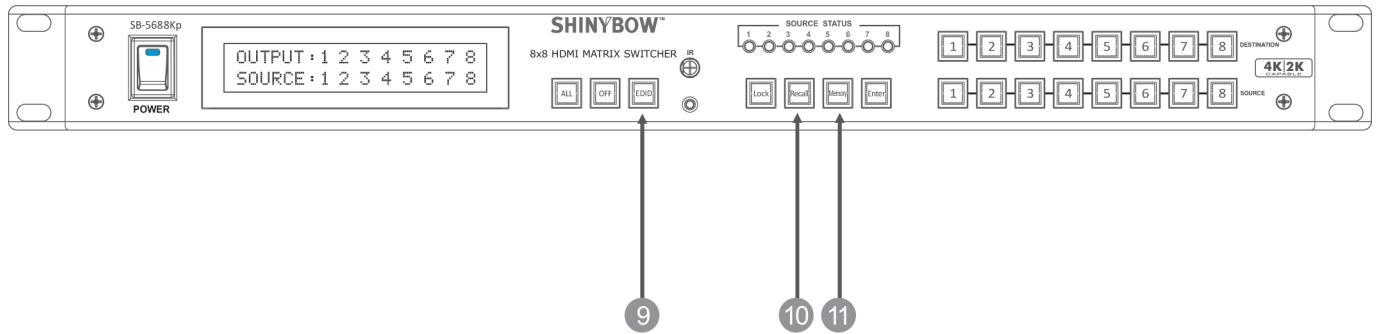

9. FUNCTION KEY - EDID:



Used to display/change current **EDID** mode.

- Press **EDID** to select new EDID mode.
- Press **SOURCE** row #1 or #2 Select EDID modes.
- Press **ENTER** to ready memory location.
- Or press **EDID** again to cancel the operation.

Operation completes.

Note: Operation will abort if no keys are pressed within 5 seconds.

10. FUNCTION KEY - RECALL:



The system will show previously stored presets, up to a total of (16). Presets are stored in local memory using Source keys 1 thru 8 or Destination keys 1 thru 8 as the memory preset location.

- Press **RECALL** button.
- Press **1 THRU 8** on either Source or Destination row.
- Press **ENTER** The pre-set configuration will execute.

Operation completes.

Note: Operation will abort if no keys are pressed within 5 seconds.

- Or press RECALL again to cancel the operation.

11. FUNCTION KEY - MEMORY:



The system will show stored presets, up to a total of (16). Presets are stored in local memory using Source keys 1 thru 8 or Destination keys 1 thru 8 as the memory preset location.

- Configure desired matrices.
- Press **MEMORY** button.
- Press **1 THRU 8** on either Source or Destination row.
- Press **ENTER** to ready memory location.
- Or press **MEMORY** again to cancel the operation.

Operation completes.

Note: Operation will abort if no keys are pressed within 5 seconds.

- Or press MEMORY again to cancel the operation.

FRONT PANEL

FRONT PANEL

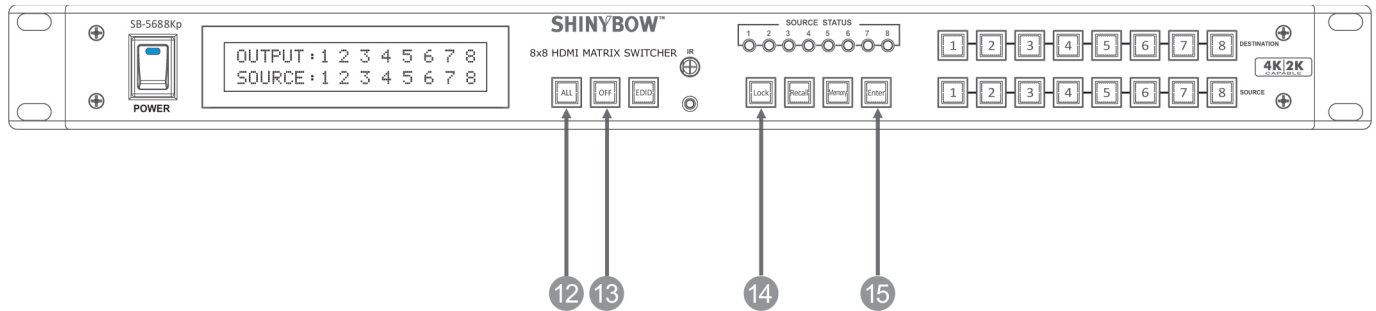

13. FUNCTION KEY - ALL:



Disables (mutes) video on all destinations OR assign the same source to all destinations.

Option 1

- Press **ALL** followed by **OFF** button. The display will show "0" to indicate none of the destinations are assigned a video source.

Option 2

- Press **ALL** followed by Source 1 thru 8. The display will show the Source selected.
- Press **ENTER**. The pre-set source selection will be assigned all destinations.

14. FUNCTION KEY - OFF:

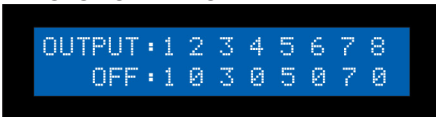

Disables (mutes) video on the selected destinations.

- Press **OFF** button followed by any Destination channel.
- Press **1 THRU 8** output destination. The display will show "0" for the selected channel, indicating no video selected.

15. FUNCTION KEY - LOCK:



- Press and hold **LOCK** button for two seconds lockout the front panel.
- Press and hold **LOCK** button for two seconds to enable the front panel.

16. FUNCTION KEY - ENTER: Press **ENTER** to confirm entries.

BACK PANEL

BACK PANEL

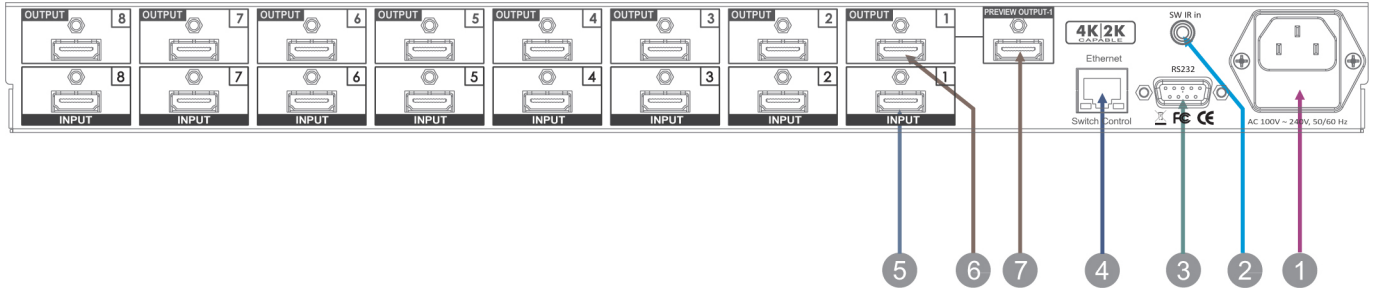

1. DC POWER INLET: The Switcher is fitted with an AC power plug input connector. Ensure that the used is of an approved type and is of sufficient current carrying connector capacity with the correct voltage and connector polarity. 100~240Volt AC, 50/60Hz power supply.



POWER SOCKET:

CONNECTOR TYPE: IEC 60320 C13

2. IR EXTENDER CONTROL: Supports (1) IR Extender. Extends maximum distance of ~984 feet/300M. When you plug the external IR extender into the switcher, the front panel IR receiver remains active.



IR EXTENDER JACK:

Female jack - inner OD Ø 3.5mm

3. RS-232 CONNECTION: RS-232 control port allows for interfacing to a PC, such as a computer or touch panel control, to the switcher via the DB-9pin female connector for serial RS-232 control.

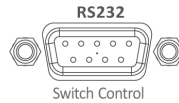

REMOTE PORT:

D-SUB-9pin female connector

4. ETHERNET CONNECTION: ETHERNET control port allows for TCP/IP interfacing to a PC, such as a computer or touch panel control (not a web-browser), to the switcher via the RJ-45 female connector to control switcher.

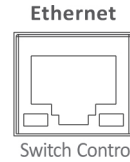

REMOTE PORT:

Control the switcher via the RJ-45 female connector

ETHERNET PORT: *Note: The Ethernet port and RS-232 port cannot be used simultaneously. Any connection to the Ethernet port will disable serial commands sent to the RS-232 port.*

5. INPUTS-1,2,3,4,5,6,7, & 8 HDMI: Connects a HDMI signal source to an Input. This HDMI port supports HDMI with embedded audio and DVI with AUX audio sources. If you remove the HDMI screw posts, you must use the provided HDMI Locking Post replacement screws to keep the internal HDMI jack secure. Removing the HDMI screws without installing the HDMI Locking Post replacement screws will void your warranty.



HDMI CONNECTOR:

HDMI Type A SMD 19pin female socket connector

Note: With the proper adapters, the switcher can be used with DVI digital video signals as it is HDCP compliant. DVI supports Audio input.

6. OUTPUTS-1,2,3,4,5,6,7 & 8 HDMI: Connects a HDMI signal source to an Output. This HDMI port supports HDMI with embedded audio and DVI with AUX audio. If you remove the HDMI screw posts, you must use the provided HDMI Locking Post replacement screws to keep the internal HDMI jack secure. Removing the HDMI screws without installing the HDMI Locking Post replacement screws will void your warranty.

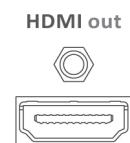

HDMI CONNECTOR:

HDMI Type A SMD 19pin female socket connector

Note: With the proper adapters, the switcher can be used with DVI digital video signals as it is HDCP compliant. DVI supports Audio input.

7. PREVIEW OUTPUT-1 HDMI: Connects a HDMI direct digital video/ audio signal link to the HDMI female connector. This connector supports HDMI digital video/audio and DVI digital video sources.



HDMI CONNECTOR:

HDMI Type A SMD 19pin female socket connector

Note: With the proper adapters, the switcher can be used with DVI digital video signals and is HDCP compliant. DVI does not support audio.

Preview port HDMI signal as the same as Output 1.

REMOTE CONTROL

Before making any connections to the switcher, observe the following:

- Ensure the main voltage supply matches the label on the supplied plug-pack (+/-10%).
- Ensure that the power switch is OFF.
- Ensure that all system grounds (earth) are connected to a common point.
- Avoid powering equipment within a system from multiple power sources that may be separated by large distances.
- Connect all audio video sources and destination equipment.
- Power up all source and destination audio-visual sources.
- For each destination output select the appropriate input source by using the front panel input select buttons. The supplied IR remote control. Or through the RS-232 serial communications port.
- Upon powering up the switcher, it will return to its last used setting before being powered down.

REMOTE CONTROL

IR REMOTE CONTROL KEY :

1. & 2. SWITCH POWER ON or OFF:

Power ON and OFF

3. DESTINATION: 1 thru 8 OUTPUT SELECTION:

Destination buttons to select the output display channel

4. SOURCE: 1 thru 8 INPUT SOURCE SELECTION:

Input 1~8 source selection buttons

5. FUNCTION KEY: Function selection buttons

ALL	OFF	EDID
MEMORY	ENTER	LOCK

RECALL

IR REMOTE : SW-5688K

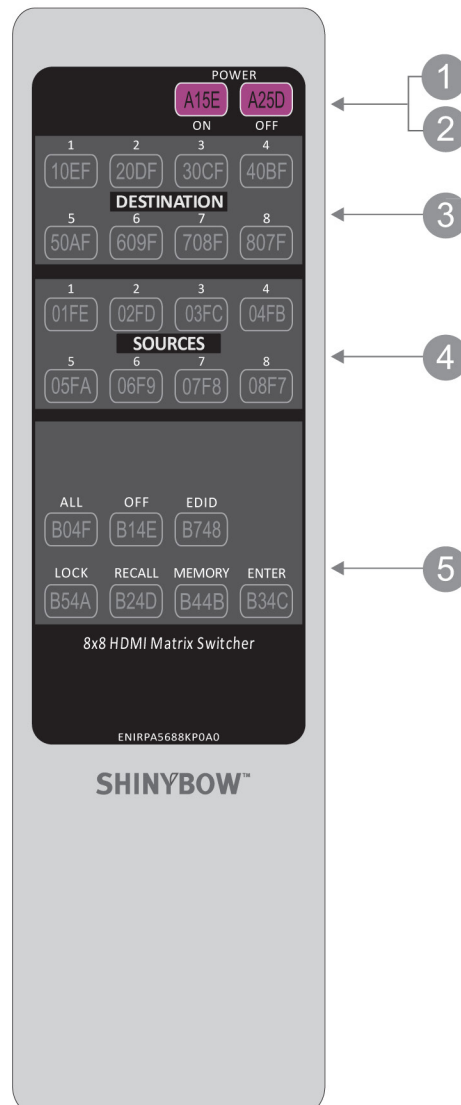

REMOTE PROTOCOL COMMANDS

IR REMOTE CUSTOM AND DATA CODES (NEC Standard)

HOW TO SETUP IR CODES:

CUSTOM CODE: 4DB2

POWER ON:	4DB2	A15E	LOCK:	4DB2	B54A
POWER OFF:	4DB2	A25D	RECALL:	4DB2	B24D
ALL:	4DB2	B04F	MEMORY:	4DB2	B44B
OFF:	4DB2	B14E	ENTER:	4DB2	B34C
EDID:	4DB2	B748			

PRESS DESTINATION - # then PRESS SOURCE -

DESTINATION #1 : 4DB2	10EF	SOURCE #1 : 4DB2	01FE
DESTINATION #2 : 4DB2	20DF	SOURCE #2 : 4DB2	02FD
DESTINATION #3 : 4DB2	30CF	SOURCE #3 : 4DB2	03FC
DESTINATION #4 : 4DB2	40BF	SOURCE #4 : 4DB2	04FB
DESTINATION #5 : 4DB2	50AF	SOURCE #5 : 4DB2	05FA
DESTINATION #6 : 4DB2	609F	SOURCE #6 : 4DB2	06F9
DESTINATION #7 : 4DB2	708F	SOURCE #7 : 4DB2	07F8
DESTINATION #8 : 4DB2	807F	SOURCE #8 : 4DB2	08F7

For Example:



Select Destination # 1 to show Source #1~8.

The IR Data Code list:





Destination # 1 , Source #1	4DB2	10EF	4DB2	01FE	01FE
Destination # 1 , Source #2	4DB2	10EF	4DB2	01FE	02FD
Destination # 1 , Source #3	4DB2	10EF	4DB2	01FE	03FC
Destination # 1 , Source #4	4DB2	10EF	4DB2	01FE	04FB
Destination # 1 , Source #5	4DB2	10EF	4DB2	01FE	05FA
Destination # 1 , Source #6	4DB2	10EF	4DB2	01FE	06F9
Destination # 1 , Source #7	4DB2	10EF	4DB2	01FE	07F8
Destination # 1 , Source #8	4DB2	10EF	4DB2	01FE	08F7

EDID FUNCTION - SYSTEM RESET/FACTORY RESET

SYSTEM RESET

SYSTEM RESET	RETURN SWITCH TO FACTORY DEFAULTS
<p>Press RECALL > OFF > ENTER</p>   	<p>RESET to Factory Default</p> <ol style="list-style-type: none"> 1. Press RECALL button: The LCM will show the current stored presets status. 2. Press OFF button: The LCM will show “SYSTEM RESET” 3. Press ENTER button: To confirm entries. The switch will reset all customizable values back to factory defaults. You must POWER CYCLE the switch for the new values to take effect.
<p>NOTE: Factory Reset Defaults to:</p> <ol style="list-style-type: none"> 1. Source Destination will be set to 1-1, 2-2, 3-3, etc. 2. Switch matrices stored in memory will be cleared. 3. Lock function will return to Un-Locked. 4. AUX function will disable and return to UN-AUX (On Select Models). 5. ARC function will disable and return to SPDIF as the Output (On Select Models). 6. EDID will return to FSS® (1080p-2ch Mode). 7. Ethernet port will return to DHCP=ENABLED. 	

RESET EDID



EDID RESET	PROCEDURE
<p>From the Front Panel: Press EDID > RECALL > OFF > ENTER</p> 	<p>RESET EDID</p> <p>Press EDID.</p> <p>Press RECALL.</p> <p>Press OFF. The display should show Reset EDID.</p> <p>Press ENTER.</p>
<p>LEARNING MODE 2</p> <p>Press EDID > OFF > DESTINATIONS > ENTER</p> <p>The EDID for HDMI has been passed from the Destination port to the Source port.</p>    	<p>SETTING EDID TO LEARNING MODE 2</p> <ol style="list-style-type: none"> 1. Press EDID button: The LCM will show the current EDID status. 2. Press OFF button: Does the OFF button stay illuminated? <ul style="list-style-type: none"> *If Yes: Press ALL the Destination buttons individually so they illuminate blue. The switcher will LEARN the destination HDMI EDID and pass to the selected source. The switcher will Enable or Disable HDMI EDID for the selected source. 3. Press ENTER to confirm changes. The LCM will return to the default screen showing selected matrix routing status. This puts you in Learning Mode 2. <ul style="list-style-type: none"> *If No: You might need a f/w update.

EDID FUNCTION

EDID FUNCTION FOR HDMI MATRIX SWITCHER

EDID SETUP	To Change The EDID Setup
Step 1. Press the EDID button	The display will show the currently selected EDID mode.
Step 2. Press SOURCE #1 OR #2 button row	The button will flash blue and the display will show the current Embedded EDID Status.
Step 3. Press the ENTER button	To set EDID mode. The switcher will return to operation mode.
Operation will abort if no keys are pressed within 5 seconds.	
EMBEDDED EDID MODES	Total 7 EDID Modes
Embedded EDID Setup Press EDID > SOURCE > ENTER SOURCE #1 or SOURCE #2 	To select Embedded EDID mode or LEARNING mode. Repeatedly pressing the SOURCE 1 button will cycle up thru the options. Repeatedly pressing the SOURCE 2 button will cycle down thru the options. Embedded EDID: Mode 1 : FSS® Mode 2 : H24-3D Mode 3 : H24-3D-M Mode 4 : H36-3D Mode 5 : H36-3D-M Mode 6 : 4K2K Mode 7 : DVI-D 1920x1200-60Hz

EDID FUNCTION FOR HDMI MATRIX SWITCHER

RESET	EDID Return To Factory Default
How to RESET EDID mode Press EDID > RECALL > ENTER   	To RESET to FACTORY DEFAULT (1080p-2CH). Press EDID button: The LCM will show the current EDID status. Press RECALL button: The LCM will show the RESET EDID . Press ENTER to confirm entries. The EDID will return to FSS® mode and resolution 1080p-2CH.
EDID STATUS	To View The Current EDID Status
Step 1. Press EDID button	The button will flash blue and the display will show the current Embedded EDID Status.
Step 2. Press EDID button	To exit.
HOW TO SETUP FSS® FUNCTION	Fast Speed Start®
Step 1. Press the DESTINATION #1~8 button row Then Press the SOURCE #1~8 button row	To setup and Install all devices.
Step 2. Press EDID button	Select a optimum status of Embedded EDID mode.
Step 3. Press ENTER button	To confirm entries.
Step 4. Press EDID button	To select the EDID FSS® mode.
Step 5. Press ENTER button	To confirm entries.

EDID FUNCTION





EDID FUNCTION FOR HDMI MATRIX SWITCHER

EDID FUNCTION: (8) EMBEDDED EDID MODES	
Mode 1. FSS® (Fast Speed Start®) EDID : 1. FAST SPEED START	Fast Speed Start® mode shortens the startup time of the switcher. Selecting this mode does not force the EDID setup to be cancelled. Users may first select one EDID mode from mode 2 to 3, and then select mode 1 for fast speed start®.
Mode 2. H24-3D (1080p-24 bits) EDID : 2. H24-3D, PCM 2CH	Audio Support: PCM 2CH
Mode 3. H24-3D-M (1080p-24 bits) EDID : 3. H24-3D, MULTI AUDIO	Audio Support: MAT(MLP) 7.1CH, PCM-2CH, One Bit Audio 2CH, AC-3 5.1CH, DTS 5.1CH, PCM 7.1CH, Dolby Digital + 7.1CH, DTS-HD 7.1CH
Mode 4. H36-3D (1080p-36 bits) EDID : 4. H36-3D, PCM 2CH	Audio Support: PCM 2CH
Mode 5. H36-3D-M (1080p-36 bits) EDID : 5. H36-3D, MULTI AUDIO	Audio Support: MAT(MLP) 7.1CH, PCM 2CH, One Bit Audio 2CH, AC-3 5.1CH, DTS 5.1CH, PCM 7.1CH, Dolby Digital + 7.1CH, DTS-HD 7.1CH
Mode 6. 4K2K (24/30Hz) EDID : 6. 4K2K-3D, PCM 2CH	HDMI Support: 4K2K-3D, PCM 2CH (3860x2160-24/30Hz) Audio Support: PCM 2CH
Mode 7. 1920x1200-60Hz (DVI-D) EDID : 7. DVI-D 1920x1200-60HZ	DVI Support: DVI-D 1920 x 1200 60Hz





EDID FUNCTION

LEARNING EDID SINGLE TO SINGLE	Learning Destination #2 EDID To Source #3
Step 1. Press EDID button	The button will flash blue and the display will show the current Embedded EDID Status.
Step 2. Press the DESTINATION #2 button row	Copy the Destination #2 Display EDID.
Step 3. Press the SOURCE #3 button row	Learning the Destination #2 EDID To Source # 3.
Step 4. Press ENTER button	To confirm entries.
LEARNING EDID SINGLE TO MULTIPLE	Learning Destination EDID Link To The Majority Sources
Step 1. Press EDID button	The button will flash blue and the display will show the current Embedded EDID Status.
Step 2. Press the DESTINATION 1-8 button row	Copy any 1~8 Destinations EDID.
Step 3. Press the SOURCE 1-8 button row	Learning the Destination EDID link to source #1-8.
Step 4. Press ENTER button	To confirm entries.
LEARNING EDID SINGLE TO ALL	Learning Destination EDID Link To All Sources
Step 1. Press EDID button	The button will flash blue and the display will show the current Embedded EDID Status.
Step 2. Press destination button 1 THRU 8	Learning anyone 1~8 Destination EDID to all sources.
Step 3. Press ALL button	Learning selected destination EDID to all sources.
Step 4. Press ENTER button	To confirm entries.
SINGLE LEARNING #1 DEFINITION	Single Learning EDID from Destination to Source
<p>1. Switcher will LEARN destination EDID and pass the selected source.</p> <p>2. To set up learning between a single destination and single source: Press EDID button > Press DESTINATION 1 THRU 8 > Press SOURCE 1 THRU 8 > Press ENTER to confirm. Switcher will learn destination EDID to source device.</p> <p>3. To set up learning between a single destination and Multiple sources: Press EDID button > Press DESTINATION 1 THRU 8 > Press the majority SOURCES 1 THRU 8 > Press ENTER. Switcher will learn single destination EDID to many source devices.</p> <p>4. How to Learning single destinations with all sources. Press EDID button > Press ALL button > Press ENTER to confirm.</p>	
MULTIPLE LEARNING #2 DEFINITION	Multiple Learning EDID from Destination to Source
<p>1. Switcher will multiple LEARN destination EDID and pass the selected source.</p> <p>2. To set up multiple learning between a single destination and single source: Press EDID button > Press OFF button > Press DESTINATION 1 THRU 8 > Press ENTER to confirm. Switcher will learn destination EDID to source device.</p> <p>3. When the Source has “Learned” the EDID data from a destination, it will save that EDID information into EPROM and the EDID data will not change. To change a saved HDMI EDID information, you have to select a new LEARNING destination to source or Disable the LEARNING.</p>	

EDID FUNCTION

LEARNING EDID MODE-#1	Learning EDID from Destination to Source
<p>Single Learning Mode#1 EDID setup</p> <p>Press</p> <p>EDID > DESTINATION > SOURCE > ENTER</p>    	<p>Key Press Sequence: EDID > DESTINATION # > SOURCE # > ENTER</p> <p>The EDID for HDMI has been learned from the Destination port to the Source port.</p> <ol style="list-style-type: none">1. Press EDID button. The LCM will show the current EDID status.2. Press DESTINATION (1-8) button. The LCM will show the LEARNING HDMI. Switcher will LEARN destination HDMI EDID.3. Press SOURCE (1-8) button. Switcher will Learning destination HDMI EDID and pass to the selected source.4. Press ENTER to confirm changes. The LCM will return to the default screen showing selected matrix routing status.
<p>NOTE : The already learned EDID cannot be modified. You can only rebuild a new Learning EDID.</p> <p>For Example: When the Source has "Learned" the EDID data from a destination, It will save that EDID information into EPROM and the EDID data cannot change. Please select new learning destination to sources or change to one of the embedded EDID modes when you want to remove the learning EDID memory from EPROM.</p>	

EDID FUNCTION

LEARNING EDID #2	Passing EDID From Destination To Source
<p>Multiple Learning mode #2 EDID setup Press EDID > OFF > DESTINATION #1 THRU #8 > ENTER</p>    	<p>The EDID for HDMI has been Learned from the Destination port to the Source port.</p> <ol style="list-style-type: none">1. Press EDID button. The LCM will show the current EDID status.2. Press OFF button. The LCM will show the current EDID LEARN status.3. Press DESTINATION (1-8) button. The switcher will LEARN the destination HDMI EDID and pass to the selected source. Switcher will Enable or Disable HDMI EDID for the selected source.4. Press ENTER to confirm changes. The LCM will return to the default screen showing selected matrix routing status.
<p>NOTE: When the Source has “Learned” the EDID data from a destination, it will save that EDID information into EPROM and the EDID data will not change. To change a saved HDMI EDID information, you have to select a new LEARNING destination to source or Disable the LEARNING</p>	

TYPICAL APPLICATION

INSTALLING DIAGRAM

Sample Connection:

Using External IR, RS-232 or Ethernet commands to control the SB-5688Kp via PC or SB-100 IR receiver to transmit the SB-5688Kp's IR signal.

NOTE:

1. Switcher IR External Port: Use SB-100 IR signal Receiver
2. 4K2K Source: Use 4K2K Blu-ray HD Source
3. Control Switch via a PC RS-232
4. Control Switch via a PC Ethernet

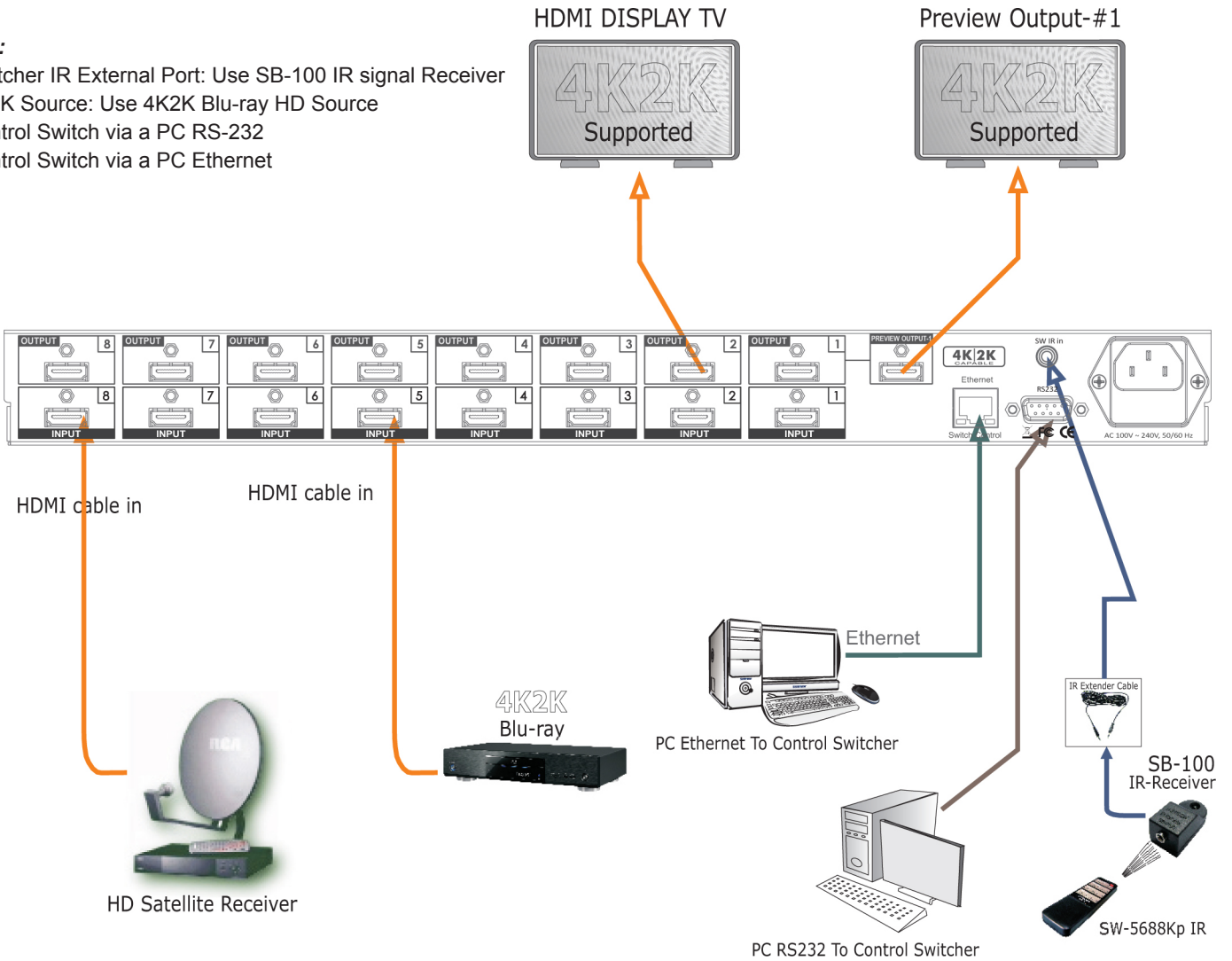

Application RS-232, IR and Ethernet to control the switcher.

ETHERNET SERIAL INTERFACE

ETHERNET SERIAL INTERFACE CONNECT A PC OR CONTROL SYSTEM. VERSION COMPATIBLE V1.0

For a complete list of commands, please reference external document extended Ethernet Protocol Instruction Manual.

Example of the commanded string to select Inputs:

Function	Command	Variables
Select source	Source xxx;	xxx = Input Channel (001=Source1, 002=Source2.etc)
Command Example	Response	Description
Source 001;	Source 001#ok;	Select source number 1

Ethernet

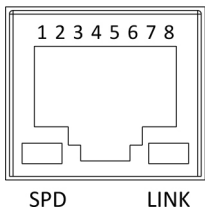

Note:

Control the switcher

SPD: Speed

LINK: Ethernet link

RJ-45 Female 8P-8 Connector

ETHERNET SERIAL INTERFACE

Pin	Ethernet	Reference
1	TXOP	TX +
2	TXON	TX -
3	RXIP	RX +
4	NC	
5	NC	
6	RXIN	RX -
7	NC	
8	GND	

ETHERNET TCP/IP PROTOCOL COMMANDS (ETHERNET V1.0)

*** The Ethernet port and RS-232 port cannot be used simultaneously. Any connection to the Ethernet Control port will disable serial commands send to the RS-232 port.***

RS-232 SERIAL INTERFACE

RS-232 SERIAL INTERFACE CONNECT A PC OR CONTROL SYSTEM. VERSION COMPATIBLE V2.0

For a complete list of commands, please reference external document extended RS-232 Protocol Instruction Manual.

Example of the commanded string to select Inputs:

Function	Command	Variables
Select source	Source xxx;	xxx = Input Channel (001=Source1, 002=Source2.etc)
Command Example	Response	Description
Source 001;	Source 001#ok;	Select source number 1

RS-232 Configuration

RS-232 cable is a straight thru cable and not null-modem

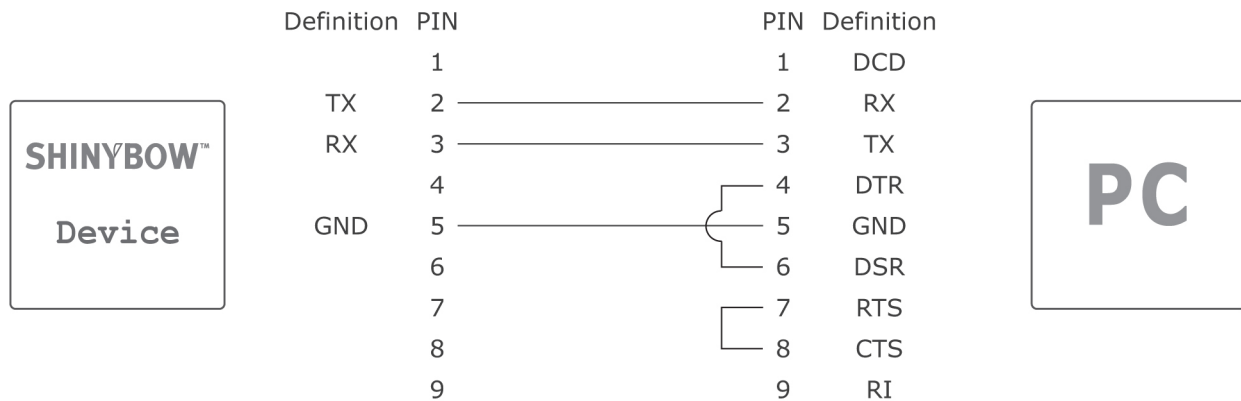

RS-232 Pin Diagram

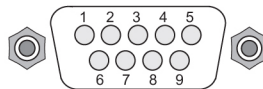

RS-232 SERIAL INTERFACE PROTOCOL COMMANDS (RS-232 CONTROL DRIVER V2.0)

The ShinybowUSA switcher can be controlled via the TCP/IP serial control port to allow for interfacing to a PC, or similar third party control system.

The serial communication parameters are 9600 baud, 8 bit, No Parity and 1 stop bit - this is often referred to as 9600 8N1. When the unit recognizes a complete command it will perform the requested action - there is no delimiter character required.

IR EXTENDER

1. SB-100 IR 300M Receiver

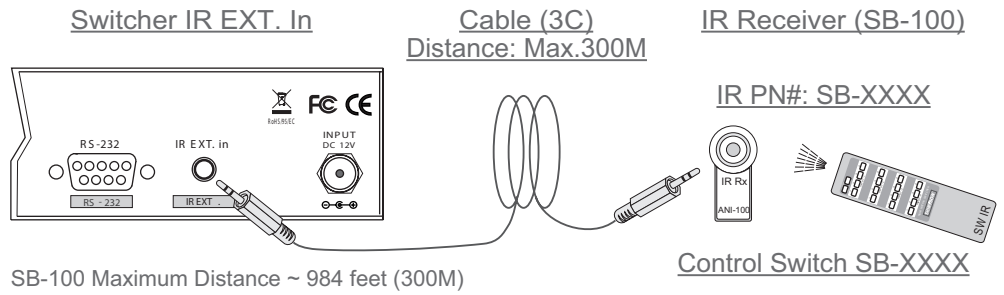

The SB-100 IR Receiver is required when using the port "ALL in" Jack.

2. SB-100C IR 2M Receiver

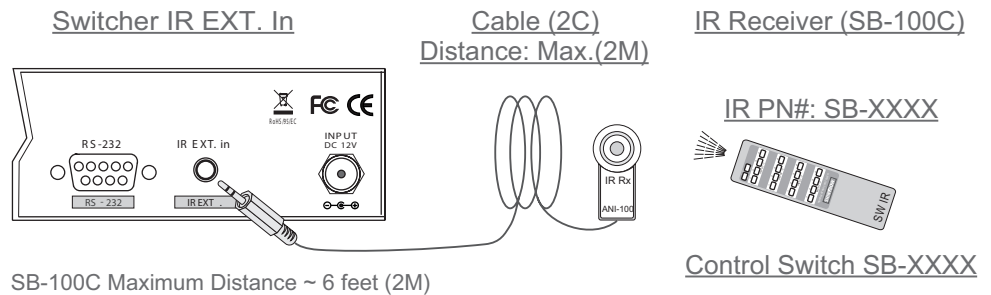

The SB-100C IR Receiver will not function on the port "ALL in" Jack.

*** When you plug the External IR extender into the switcher, the front panel IR receiver remains active. ***

Pin configuration for IR 984 feet (300M) Extender Receiver such as SB-100 compatible

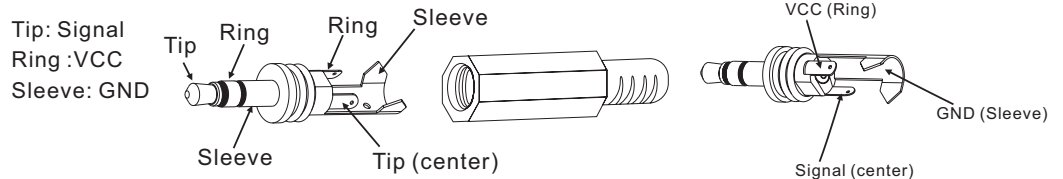

SB-100 Receiver and SB-101 Transmitter The DISTANCE maximum ~ 984 feet (300M)

Pin configuration for IR Receiver 6 feet (2M) cable such as SB-100C compatible

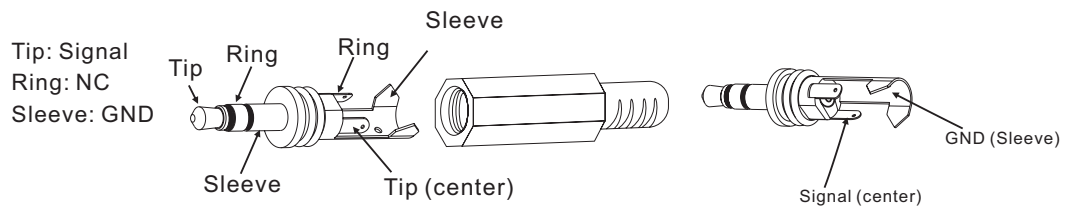

SB-100 Receiver and SB-101C Transmitter The DISTANCE maximum ~ 984 feet (300M)

Note: The External IR jack has voltage on the "Ring" portion of a 3-conductor plug. You must use a 3-conductor plug (aka: stereo plug). Using a 2-conductor plug will short out the power supply. Always make connections with the switcher power off.

The frequency range of the IR emitter and receivers is 38khz.

HDBASET™ APPLICATION

HDBASET™ MATRIX SWITCHER USING HDBASET™ TRANSMITTERS & RECEIVER (SOLD SEPARATELY).

SB-6335T5: HDBaseT™ Transmitter with PoE

Distance: Max. 100M

INPUTS:

1. (1) HDMI source
2. (1) F/W update

OUTPUTS:

1. (1) HDBaseT™ out

Controls:

- (1) RS-232, (1) IR in, (1) IR out, (1) LAN (Ethernet)



FRONT PANEL: HDBaseT™ 100M Transmitter

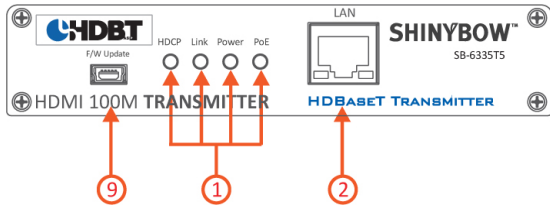

BACK PANEL: HDBaseT™ 100M Transmitter

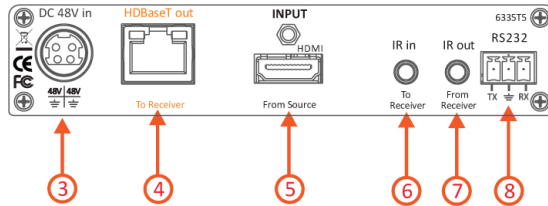

1. Status via LED Show out: HDCP, Link, Power & PoE
2. (1) Ethernet path to HDBaseT™ Receiver
3. DC Input: 48V, with PoE Transmitter
4. RJ-45 Out: HDBaseT™ signal output to HDBaseT™ Receiver

5. HDMI In: HDMI signal input from HDMI source device
6. IR In: IR signal to HDBaseT™ Receiver
7. IR Out: IR signal from HDBaseT™ Receiver
8. RS-232 i/o: RS-232 series interface control via a PC
9. USB In: F/W Update

SB-6335R5: HDBaseT™ Receiver with PoE

Distance: Max. 100M

INPUTS:

1. (1) HDBaseT™ in
2. (1) F/W Update

OUTPUTS:

1. (1) HDMI out

Controls:

- (1) RS-232, (1) IR in, (1) IR out, (1) LAN (Ethernet)



FRONT PANEL: HDBaseT™ 100M Receiver

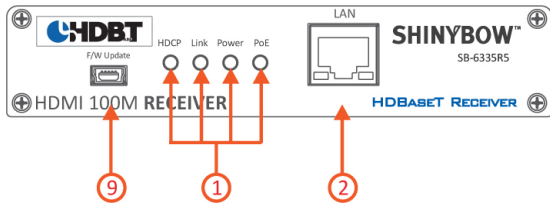

BACK PANEL: HDBaseT™ 100M Receiver

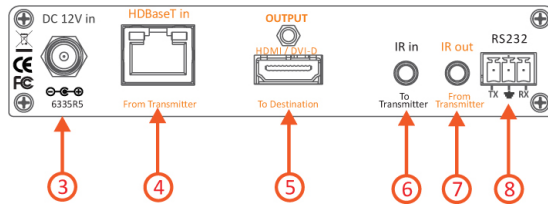

1. Status via LED Show out: HDCP, Link, Power & PoE
2. (1) Ethernet path to HDBaseT™ Transmitter
3. Extra DC Input: 12V, Transmitter without support Power
4. RJ-45 In: HDBaseT™ signal input from HDBaseT™ Transmitter

5. HDMI Out: HDMI signal output to destination HDMI device
6. IR In: IR signal to HDBaseT™ Transmitter
7. IR Out : IR signal from HDBaseT™ Transmitter
8. RS-232 i/o : RS-232 series interface control via a PC
9. USB In: F/W Update

HDBASET™ APPLICATION

RACKMOUNT: (OPTIONAL)

SB-6075A: SB-6335T/R 19 INCH 1RU-1UNIT RACK MOUNT

Model No.: #1U-1p-L440-44MM



SB-6075B: SB-6335T/R 19 INCH 1RU-2UNIT RACK MOUNT

Model No. : #1U-2p-L440-44MM

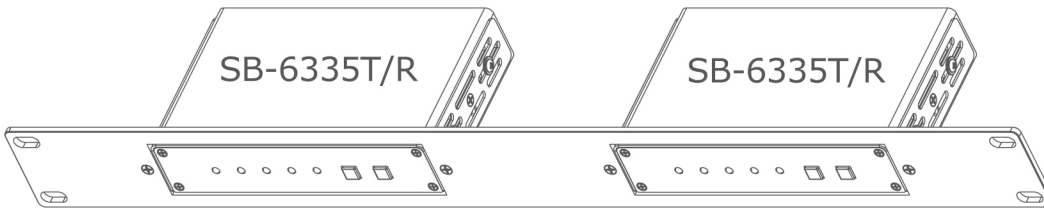

SB-6069: SB-6335T/R 19 INCH 4U-10P RACK MOUNT

Model No. : #4U-10p-L130MM

SB-6335T/R 4U Ear mount pairs

Parts No.: MEER6069ER13000

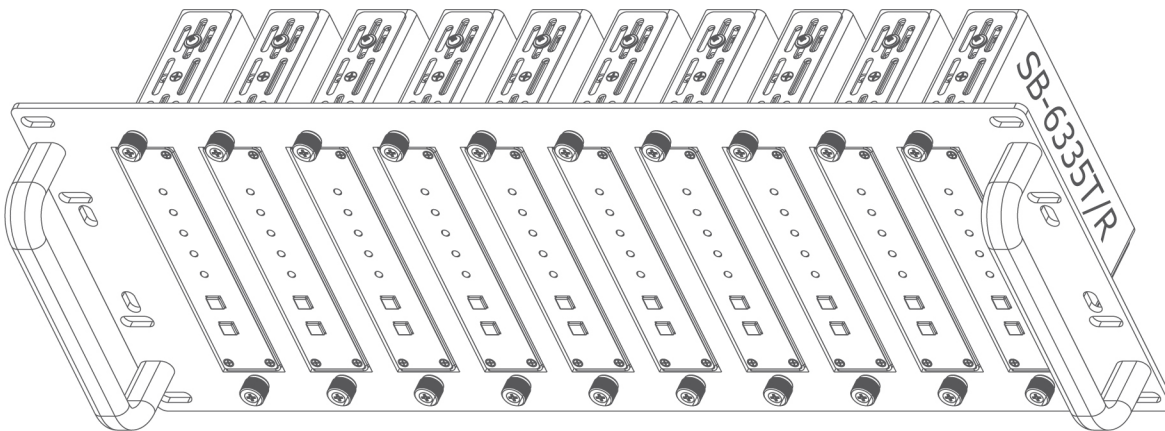

HDBASET™ APPLICATION

19 INCH RACK MOUNT BRACKET FOR SB-6335T AND/OR SB-6335R: (OPTIONAL)

Complete 19 inch 4U rack mount of SB-6069

Install Application: **SB-6335T/R**

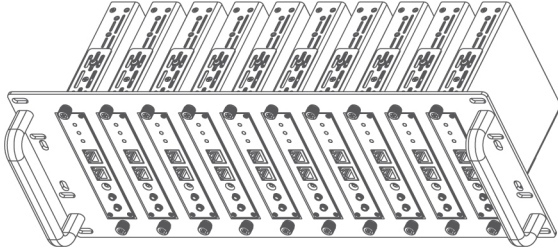

SB-6069 (optional)

SB-6335TR: 19 INCH 4U-10P RACK MOUNT

Model No.: #4U-10p-M130MM

SB-6335T/R 4U Ear mount pairs

Parts No.: MEER6069ER13000

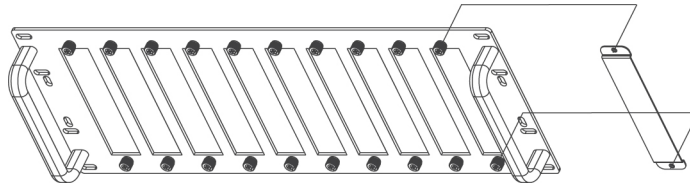

Model No.: #4U-10p-M130MM-COV

SB-6335T/R 4U Ear mount pairs

Parts No.: MEER6069ER11000



SB-6335T/R: Wall mount accessories

Model No.: #WM-1INCH-130MM

SB-6335T/R Wall mount pairs

Parts No.: MEER6335ER11000

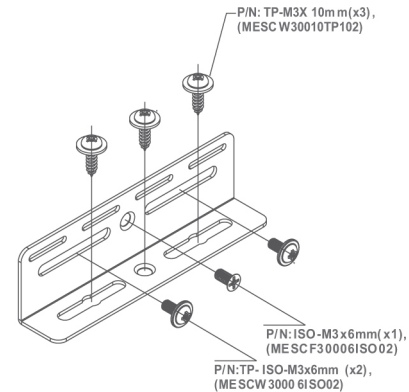
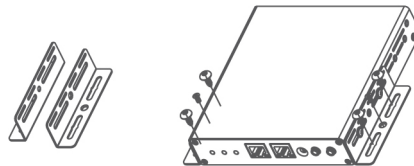

Model No.: #4U-10p-M130MM-EAR

SB-6335T/R 4U Ear mount pairs

Parts No.: MEER6335ER11001

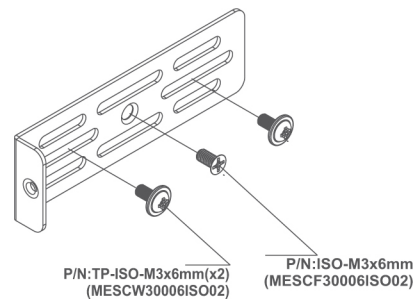
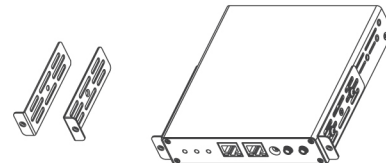

THIS PAGE IS INTENTIONALLY LEFT BLANK.

LIMITED WARRANTY

PLEASE READ THE FOLLOWING TERMS AND CONDITIONS CAREFULLY BEFORE USING THIS HARDWARE, COMPONENTS AND SOFTWARE PROVIDED BY, THROUGH OR UNDER SHINYBOWUSA, INC (COLLECTIVELY, THE "PRODUCT"). By using installing or using the Product, you unconditionally signify your agreement to these Terms and Conditions. If you do not agree to these Terms and Conditions, do not use the Product and return the Product to SHINYBOWUSA, Inc. at the return address set forth on the Product's packing label at your expense. SHINYBOWUSA, Inc. may modify these Terms and Conditions at anytime, without notice to you.

RESTRICTIONS ON USE OF THE PRODUCT

It is your responsibility to read and understand the installation and operation instructions, both verbal and in writing, provided to you with respect to the Product. You are authorized to use the Product solely in connection with such instructions. Any use of the Product not in accordance with such instructions shall void any warranty pertaining to the Product. Any and all damages that may occur in the use of the Product that is not strictly in accordance with such instructions shall be borne by you and you agree to indemnify and hold harmless SHINYBOWUSA, Inc. from and against any such damage.

The Product is protected by certain intellectual property rights owned by or licensed to SHINYBOWUSA. Any intellectual property rights pertaining to the Product are licensed to you by SHINYBOWUSA, Inc. and/or its affiliates, including any manufacturers or distributors of the Product (collectively, "SHINYBOWUSA") for your personal use only, provided that you do not change or delete any proprietary notices that may be provided with respect to the Product.

The Product is sold to you and any use of any associated intellectual property is deemed to be licensed to you by SHINYBOWUSA for your personal use only. SHINYBOWUSA does not transfer either the title or the intellectual property rights to the Product and SHINYBOWUSA retains full and complete title to the intellectual property rights therein. All trademarks and logos are owned by SHINYBOWUSA or its licensors and providers of the Product, and you may not copy or use them in any manner without the prior written consent of SHINYBOWUSA, which consent may be withheld at the sole discretion of SHINYBOWUSA.

The functionality and usability of the Product is controlled by SHINYBOWUSA, Inc. from its offices within the State of Texas, United States of America. SHINYBOWUSA makes no representation that materials pertaining to the Product are appropriate or available for use in other locations other than the shipping address you provided with respect thereto. You are advised that the Product may be subject to U.S. export controls.

DISCLAIMERS AND LIMITATION OF LIABILITY

SHINYBOWUSA may change or modify the Product at any time, from time to time.

THE PRODUCT IS PROVIDED "AS IS" AND WITHOUT WARRANTIES OF ANY KIND EITHER EXPRESS OR IMPLIED. SHINYBOWUSA DOES NOT WARRANT OR MAKE ANY REPRESENTATIONS REGARDING THE USE OR THE RESULTS OF THE USE OF THE PRODUCT'S CORRECTNESS, ACCURACY, RELIABILITY, OR OTHERWISE.

SHINYBOWUSA has no duty or policy to update any information or statements pertaining to the Product and, therefore, such information or statements should not be relied upon as being current as of the date you use the Product. Moreover, any portion of the materials pertaining to the Product may include technical inaccuracies or typographical errors. Changes may be made from time to time without notice with respect to the Product.

TO THE FULLEST EXTENT PERMISSIBLE PURSUANT TO APPLICABLE LAW, SHINYBOWUSA DISCLAIMS ALL WARRANTIES, EXPRESS OR IMPLIED, INCLUDING, BUT NOT LIMITED TO IMPLIED WARRANTIES OF MERCHANTABILITY, FITNESS FOR A PARTICULAR PURPOSE AND NON-INFRINGEMENT. SHINYBOWUSA DOES NOT WARRANT THE ACCURACY, COMPLETENESS OR USEFULNESS OF ANY INFORMATION WITH RESPECT TO THE PRODUCT. SHINYBOWUSA DOES NOT WARRANT THAT THE FUNCTIONS PERTAINING TO THE PRODUCT WILL BE ERROR-FREE, THAT DEFECTS WITH RESPECT TO THE PRODUCT WILL BE CORRECTED, OR THAT THE MATERIALS PERTAINING THERETO ARE FREE OF DEFECTS OR OTHER HARMFUL COMPONENTS. SHINYBOWUSA WILL USE ITS REASONABLE EFFORTS TO CORRECT ANY DEFECTS IN THE PRODUCT UPON TIMELY WRITTEN NOTICE FROM YOU NOT TO EXCEED 10 BUSINESS DAYS AFTER RECEIPT BY YOU OF THE PRODUCT, BUT YOU (AND NOT SHINYBOWUSA) ASSUME THE ENTIRE COST OF ALL NECESSARY SERVICING, REPAIR AND CORRECTION THAT WAS CAUSED BY YOU UNLESS OTHERWISE AGREED TO IN A SEPARATE WRITING BY SHINYBOWUSA.

UNDER NO CIRCUMSTANCES, INCLUDING, BUT NOT LIMITED TO, NEGLIGENCE, SHALL SHINYBOWUSA BE LIABLE FOR ANY SPECIAL OR CONSEQUENTIAL DAMAGES THAT RESULT FROM THE USE OF, OR THE INABILITY TO USE THE PRODUCT IN ACCORDANCE WITH ITS SPECIFICATIONS, EVEN IF SHINYBOWUSA OR ITS REPRESENTATIVES HAVE BEEN ADVISED OF THE POSSIBILITY OF SUCH DAMAGES. IN NO EVENT SHALL SHINYBOWUSA'S TOTAL LIABILITY TO YOU FROM ALL DAMAGES, LOSSES, AND CAUSES OF ACTION (WHETHER IN CONTRACT, OR OTHERWISE) EXCEED THE AMOUNT YOU PAID TO SHINYBOWUSA, IF ANY, FOR THE PRODUCT.

END OF DOCUMENT

122 Rose Ln. Suite 303 | Frisco, Texas 75034

1-877-SHINY-USA

1-877-744-6987

1-972-377-2508

sales@shinybowusa.com

www.shinybowusa.com

SHINYBOW™ USA
MULTIMEDIA AUDIO AND VISUAL