

SB-5648K

4x8 HDMI MATRIX SWITCHER



IMPORTANT WARRANTY INFORMATION.

If you remove the HDMI screw posts, you must use the provided HDMI Locking Post replacement screws to keep the internal HDMI jack secure. Removing the HDMI screws without installing the HDMI Locking Post replacement screws will void your warranty.



SAFETY INFORMATION



1. To ensure the best results from this product, please read this manual and all other documentation before operating your equipment. Retain all documentation for future reference.
2. Follow all instructions printed on unit chassis for proper operation.
3. To reduce the risk of fire, do not spill water or other liquids into or on the unit, or operate the unit while standing in liquid.
4. Make sure power outlets conform to the power requirements listed on the back of the unit. Keep unit protected from rain, water and excessive moisture.
5. Do not attempt to clean the unit with chemical solvents or aerosol cleaners, as this may damage the unit. Dust with a clean dry cloth.
6. Do not use the unit if the electrical power cord is frayed or broken. The power supply cords should be routed so that they are not likely to be walked on or pinched by items placed upon or against them, paying particular attention to cords and plugs, convenience receptacles, and the point where they exit from the appliance.
7. Do not force switched or external connections in any way. They should all connect easily, without needing to be forced.
8. Always operate the unit with the AC ground wire connected to the electrical system ground. Precautions should be taken so that the means of grounding of a piece of equipment is not defeated.
9. AC voltage must be correct and the same as that printed on the rear of the unit. Damage caused by connection to improper AC voltage is not covered by any warranty.
10. Turn power off and disconnect unit from AC current before making connections.
11. Never hold a power switch in the "ON" position.
12. This unit should be installed in a cool dry place, away from sources of excessive heat, vibration, dust, moisture and cold. Do not use the unit near stoves, heat registers, radiators, or other heat producing devices.
13. Do not block fan intake or exhaust ports. Do not operate equipment on a surface or in an environment which may impede the normal flow of air around the unit, such as a bed, rug, carpet, or completely enclosed rack. If the unit is used in an extremely dusty or smoky environment, the unit should be periodically "blown free" of foreign dust and matter.
14. To reduce the risk of electric shock, do not remove the cover. There are no user serviceable parts inside. Refer all servicing to qualified service personnel. There are no user serviceable parts inside.
15. When moving the unit, disconnect input ports first, then remove the power cable; finally, disconnect the interconnecting cables to other devices.
16. Do not drive the inputs with a signal level greater than that required to drive equipment to full output.
17. The equipment power cord should be unplugged from the outlet when left unused for a long period of time.
18. Save the carton and packing material even if the equipment has arrived in good condition. Should you ever need to ship the unit, use only the original factory packing.
19. Service Information Equipment should be serviced by qualified service personnel when:
 - A. The power supply cord or the plug has been damaged.
 - B. Objects have fallen, or liquid has been spilled into the equipment.
 - C. The equipment has been exposed to rain.
 - D. The equipment does not appear to operate normally, or exhibits a marked change in performance.
 - E. The equipment has been dropped, or the enclosure damaged.

TABLE OF CONTENTS

HDMI Matrix Switcher Series

Thank you for purchasing the SB-5648K 4x8 HDMI Matrix Switcher. You will find this unit easy to install and highly reliable but it is essential that you read this manual thoroughly before attempting to use 4x8 HDMI Matrix switcher.

CONTENTS

INTRODUCTION	1
FEATURES & CONTENTS.....	2
SPECIFICATIONS	3
FRONT PANEL	4
BACK PANEL	7
REMOTE CONTROL	8
RS-232 / ETHERNET SERIAL INTERFACE	10
EDID FUNCTIONS	11
IR EXTENDER	14
TYPICAL APPLICATION	15

INTRODUCTION

The SB-5648K is professional 4x8 matrix routing switch. Supporting (4) HDMI Inputs and (8) HDMI and (1) Preview Output (same as Output-01) Outputs. The SB-5648K is based on the HDMI standards and supports full resolution HDMI Video with embedded EDID. With a signal bandwidth of 340Mhz, there is no signal degradation. High Definition Digital signals can be selected and distributed to any (4) Inputs to the (8) outputs simultaneously. The switcher is certified as being fully CEC and HDCP 1.3 compliant, full HD HDMI V1.4a 3D formats with data rates up to 6.75Gbps. Supports UXGA/WUXGA/DVI 1920x1200 resolution to any HD display. This switcher is certified as being fully HDMI and HDCP 1.3 compliant, with RoHS, CE, FCC certifications. Supports high resolution HDMI sources routed to HDMI displays, monitors, projector or audio receivers. EDID management can be selected between (8) different modes. Control is provided via front panel push buttons, IR remote, RS-232 or TCP/IP (not a web-browser). A RS-232 Windows GUI interface is provided for matrix routing control (Windows only). This product has a 3 year warranty.

SAFETY PRECAUTIONS

Please read all instructions before attempting to unpack, install or operate this equipment and before connecting the power supply. Please keep the following in mind as you unpack and install this equipment:

- Always follow basic safety precautions to reduce the risk of fire, electrical shock and injury to persons.
- To prevent fire or shock hazard, do not expose the unit to rain, moisture or install this product near water.
- Never spill liquid of any kind on or into this product.
- Never push an object of any kind into this product through any openings or empty slots in the unit, as you may damage parts inside the unit.
- Do not attach the power supply cabling to building surfaces.
- Use only the supplied power supply unit (PSU). Do not use the PSU if it is damaged.
- Do not allow anything to rest on the power cabling or allow any weight to be placed upon it or any person walk on it.
- To protect the unit from overheating, do not block any vents or openings in the unit housing that provide ventilation and allow for sufficient space for air to circulate around the unit.

DISCLAIMERS

The information in this manual has been carefully checked and is believed to be accurate. We assume no responsibility for any infringements of patents or other rights of third parties which may result from its use.

We assume no responsibility for any inaccuracies that may be contained in this document. We make no commitment to update or to keep current the information contained in this document.

We reserve the right to make improvements to this document and/or product at any time and without notice.

COPYRIGHT NOTICE

No part of this document may be reproduced, transmitted, transcribed, stored in a retrieval system, or any of its part translated into any language or computer file, in any form or by any means — electronic, mechanical, magnetic, optical, chemical, manual, or otherwise — without express written permission and consent.

© Copyright 2017. All Rights Reserved.

Version 1.0 MAR 2017

5648K-20170328-001

TRADEMARK ACKNOWLEDGMENTS

All products or service names mentioned in this document may be trademarks of the companies with which they are associated.

LOOK A PUPPY!! NOW READ THIS!!



IMPORTANT WARRANTY INFORMATION.

If you remove the HDMI screw posts, you must use the provided HDMI Locking Post replacement screws to keep the internal HDMI jack secure. Removing the HDMI screws without installing the HDMI Locking Post replacement screws will void your warranty.

FEATURES

FEATURES

- (4) HDMI source devices matrix switched to (8) HDMI Outputs + (1) Preview Output destinations
- HDMI digital video w/ embedded HDCP, DVI formats and CEC/HDCP 1.3 compliant
- Worldwide EDID control modes for HDMI full 4K2K@30Hz HD Video resolutions
- Wide frequency range: 25MHz ~ 340MHz, Supports HDMI 4K2K@30Hz, 1.4a 3D formats
- Wide range of HD resolutions from PC XGA to WUXGA 1920x1200 and HDTV/DTV HDMI resolutions 480i/480p, 576i/576p, 720p, 1080i/p & 4K2K@24/30Hz
- Compatible with all HDMI source devices, PC monitors, Plasma HD display, HDTV and audio receivers or audio amplifiers
- Digital Video TMDS formats resolutions up to 4K2K@30Hz with Deep color 36-bit
- Using the build-in booster, each HDMI output port is capable of driving cable lengths for 1080p up to 98 ft (30M) & 4K2K up to 66 ft (20M)
- Digital Audio supports Dolby TrueHD, Dolby Digital, Dolby Digital Plug/ex, DTS, DTS-HD, DTS-HD Master, DTS-EX, PCM, PCM2, LPCM2
- Audio Input supports Auxiliary Audio (Analog stereo audio)
- Audio Output supports digital audio ARC or digital audio S/PDIF (from a HDMI source or Auxiliary Audio)
- Various User Interface Controls:
 - Windows based GUI control via RS-232 interface control driver for 2000/XP/WIN7-32/WIN7-64/WIN8
 - Front panel push buttons
 - IR remote control
 - Ethernet switch control
 - Third party RS-232 control (via simple ASCII)
- Supports (7) world wide control function keys: Full function front panel controls: ALL / OFF / EDID / LOCK / RECALL / MEMORY / ENTER
- Supported EDID Modes:
 - Embedded EDID modes: FSS/ H24-3D/ H24-3D-M/ H36-3D/ H36-3D-M/ 4K2K-3D / DVI-D 1920x1200-60Hz
 - External modes: Learning Mode-1 (Single Learning) & Learning Mode-2 (Multiple Learning)
- Automatic scanning of input & output status via LCM display on the front panel
- Supports IR remote and IR extender for distances up to ~ 984 ft (300M) maximum
- Supports universal power adaptor 12VDC, 5A, (AC100V~AC240V, 50/60Hz)

The switcher will remember that last state during a power cycle. When power is removed and resorted, the last configuration will be invoked.

PACKAGE CONTENTS

Check that you have the following components:

- SB-5648K Matrix Switcher
- RS-232 V2.0 / Ethernet V1.0 Protocol Instructions
- Master Wireless IR Remote Control (SW-5648)
- 19 inch Ear mount bracket (Part # 1U-440L)
- SB-100 IR Extender Receiver Set
- CD Contents: Manual, Windows GUI, ISP V1.0 Windows driver
- RS-232 Cable 6 feet (2M)
- HDMI Locking Post Replacement Screws
- Users Guide
- Worldwide Universal Power Supply: DC12V, 5A, Input: (100~240VAC, AC 50/60Hz)
- *Optional: SB-100C IR Extender Receiver Cable (6.5ft (2M))*



SPECIFICATIONS

SPECIFICATIONS

- **Type of HDMI Switcher:** (4) HDMI Inputs to (8) HDMI Outputs Matrix Switcher
- **HDMI Supported:** HDMI 4K2K@30Hz, H36-bit Deep color, 3D of HDMI V1.4 formats
- **HDCP / CEC Supported:** HDCP 1.3 Compliant, CEC Compliant
- **Video Bandwidth:** Double Data Rates: 340Mhz, total 6.75Gbps bandwidth
- **Digital Video Supported:** Full HD Resolution : 480i / 480p / 720p / 1080i / 1080p
- **Digital Audio Supported:** Multi Audio Formats 5.1 / 7.1, MAT (MLP), Dolby Digital, Dolby TrueHD, Dolby Digital Plus, DTS, DTS-ES 6.1, DTS-HD, DTS-HD-HRA, DTS-HD Master, (PCM-2CH)
- **Controls:**
 - IR Remote Control (remote switcher)
 - Select & Function buttons on front panel
 - IR External port (switch control)
 - RS-232 series interface (switch control)
 - Ethernet TCP/IP series interface (switch control)
- **Preview Output Supported:** (1) preview output port simultaneously supported via Output-#1
- **Source Status:** Automatically scans source inputs via LED
- **Function Control Keys:** ALL / OFF / RECALL / ENTER / MEMORY / LOCK / EDID
- **Infrared Frequency:** 38Khz
- **IR External Distance:** ~984 feet / 300M maximum
- **HDMI I/O Connector:** HDMI Type A - SMD 19pin female type
- **Temperature:** 32°F - 100°F Operation (0°C - 38°C)
- **Dimensions (LxWxH):** 19 x 9.85 x 1.75 in (482x250x44mm)
- **Rack Mount:** 1RU High 19in Rack Mount #1U-440L (with rack mount)
- **Power Supply:** DC12V, 5A, Power Input: AC 100~240VAC 50/60Hz (universal type)
- **Power Consumption:** 2580mA Maximum
- **Safety Approvals:** CE, FCC, RoHS
- **Weight:** 2.05 Kgs / 3.42 lb (Unit only)

As product improvements are continuous, specifications are subject to change and without notice.

Because of limitations on source and display devices, not all EDID data is compatible and subsequently not all equipment will function correctly with this switcher.

FRONT PANEL

FRONT PANEL

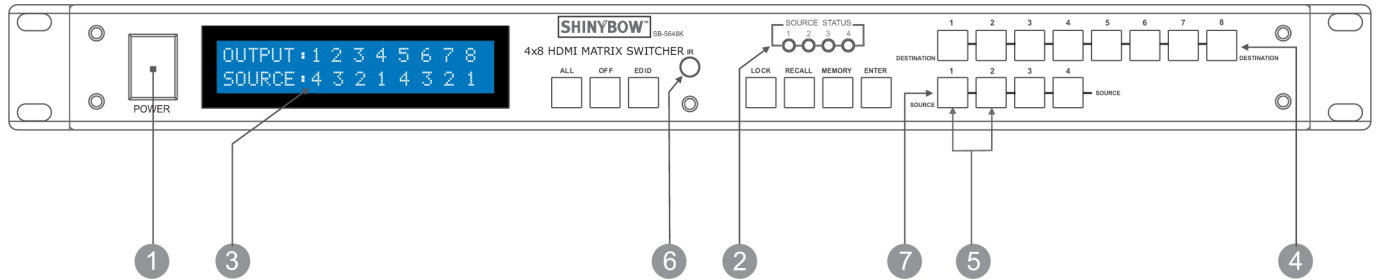

1. POWER SWITCH: The power switch turns the unit on and off. The LED will illuminate blue to indicate that the switcher is ON and is receiving power. The switcher will remember that last state during a power cycle. When power is removed and resorted, the last configuration will be evoked.

2. INPUT STATUS DISPLAY: Input sources 1 to 4 LED illuminates blue to indicate that a video source is present on that input.

3. OUTPUT STATUS DISPLAY: Each Output (destination) Channel shows which Input (source) is assigned.

4. DESTINATION SELECT BUTTONS: Separate outputs 1 thru 8 select buttons are provided for each destination assignment. Routing can be source to destination or one source to multiple destinations.

Example: Press Destination 1,3,5. Then press Source 2, it will route Input 2 to Output 1,3,5 respectively.

5. EDID MODE SELECT BUTTONS: Used to select EDID mode using Source buttons #1 or #2.

6. IR SENSOR: The IR sensor receives IR commands from the supplied remote control or third party IR emitter.

7. SOURCE SELECT BUTTONS: Separate inputs 1 thru 4 select buttons are provided for each source selection.

FRONT PANEL

FRONT PANEL

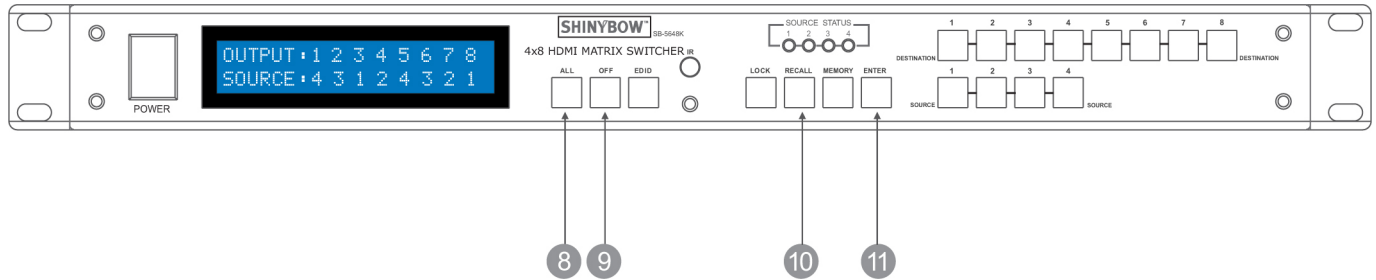

8. FUNCTION KEY - ALL:



Disables (mutes) video on all destinations OR Selects the same source to all destinations.

Option 1

- Press **ALL** followed by the **OFF** button. The display will show "0" indicating all destinations have no video selected.

Option 2

- Press **ALL** followed by Source **1 THRU 4**. The display will show the Source selected.
 - Press **ENTER**. The pre-set source selection will be assigned to all destinations.

9. FUNCTION KEY - OFF:



Disables (mutes) video to the selected channels or either destination.

- Press **OFF** button followed by any Destination channel.
 - Press **1 THRU 8** output destinations. The display will show "0" for the selected channel indicating no video selected.

10. FUNCTION KEY - RECALL:

The system will show previously stored presets, up to a total of (12). Presets are stored in local memory using Source keys 1 thru 4 or Destination keys 1 thru 8 as the memory preset location.



- Press **RECALL** button.
 - Press **1 THRU 4** on either the Source or **1 THRU 8** Destination row.
 - Press **ENTER**. The pre-set configuration will execute.

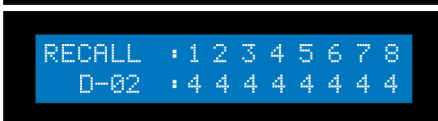

Operation completes.

Note: Operation will abort if no keys are pressed within 5 seconds.

11. FUNCTION KEY - ENTER: Press **ENTER** to confirm entries.

FRONT PANEL

FRONT PANEL

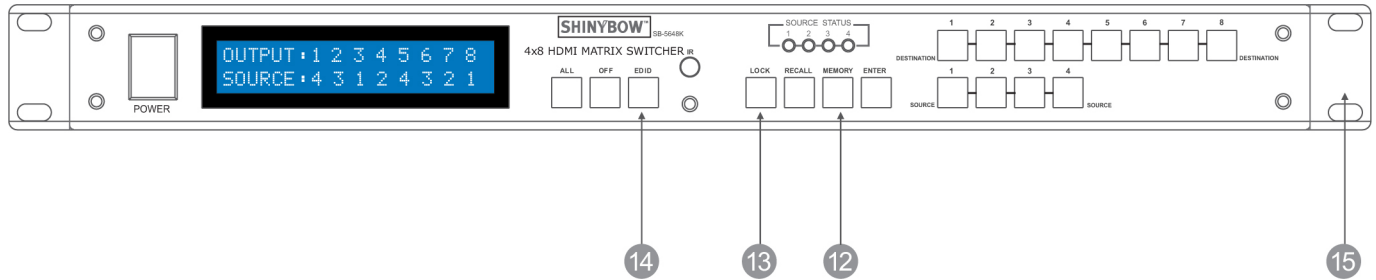

12. FUNCTION KEY - MEMORY:

The system will show stored presets, up to a total of (12). Presets are stored in local memory using Source keys 1 thru 4 or Destination keys 1 thru 8 as the memory preset location.

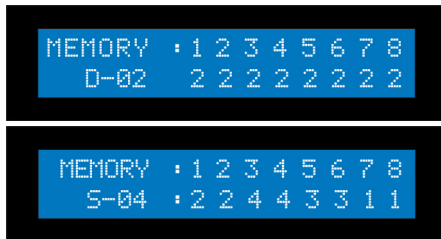

- Configure desired matrices.
- Press **MEMORY** button.
- Press **1 THRU 4** on either Source or **1 THRU 8** Destination row.
- Press **ENTER** to ready the memory location.
- Or press **MEMORY** again to cancel the operation.

Operation completes.

Note: Operation will abort if no keys are pressed within 5 seconds.

13. FUNCTION KEY - LOCK:



- Press and hold **LOCK** button for two seconds lockout the front panel.
- Press and hold **LOCK** button for two seconds to enable the front panel.

14. FUNCTION KEY - EDID:

Used to display change current EDID mode.

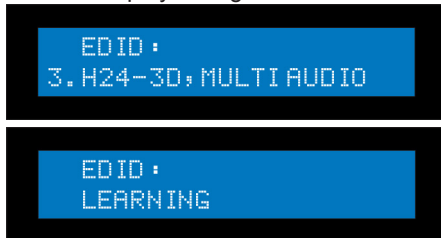

- Press **EDID** to select the new EDID mode or selection.
- Press Source row **#1** or **#2** to select EDID modes.
- Press the **DESTINATION #** to learn EDID. The Destination EDID has been learned.

15. 19 INCH EAR MOUNT PAIR: Converts desktop to 19 inch rack mount. Bracket (part # 1U-440L) INCLUDED. Image shows rack mount brackets attached.

BACK PANEL

BACK PANEL

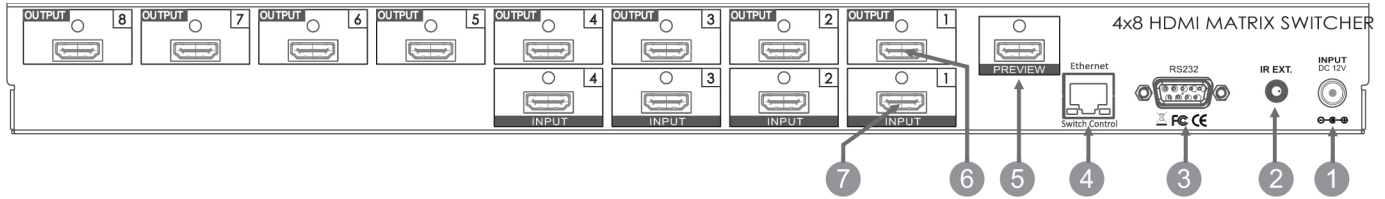

1. DC POWER INLET: The switcher is fitted with a DC power plug input connector. Ensure that the plug used is of an approved type and is of sufficient current carrying connector capacity with the correct voltage and connector polarity. 12Volt DC power supply 5A Max (Center pin positive).



POWER JACK:

DC Jack - Inner OD Ø 2.1mm (+)
Outside OD Ø 5.5mm (GND)
Power Input - 12VDC, 5A

2. IR EXTENDER CONTROL: Supports one IR extender. (IR Input) Extends a maximum distance ~984 feet/300M.
Note: DO NOT install or remote this connection with the power ON.



IR EXTENDER JACK: Female Jack - inner OD Ø 3.5mm

3. RS-232 CONNECTION: RS-232 control port allows for interfacing to a PC, such as a computer or touch panel control, to the switcher via the DB-9pin female connector for serial RS-232 control.

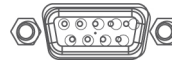

This port is also for firmware updates

REMOTE PORT: D-SUB-9pin female connector

4. ETHERNET CONNECTION: ETHERNET control port allows for TCP/IP interfacing to a PC, such as a computer or touch panel control (not a web-browser), to the switcher via the RJ-45 female connector to control the switcher.

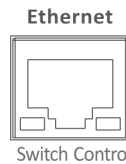

REMOTE PORT: Controls the switcher via a RJ-45 female connector

ETHERNET PORT:

Note: The Ethernet port and RS-232 port cannot be used simultaneously. Any connection to the Ethernet port will disable serial commands sent to the RS-232 port.

5. PREVIEW OUTPUT-01 HDMI: Connects a HDMI signal direct digital video/audio to the female HDMI connector. This connector supports HDMI digital video/audio and DVI digital video sources. Preview port HDMI signal is the same as Output.

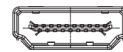

HDMI DIGITAL VIDEO/AUDIO CONNECTOR:

HDMI female connector.
Note: With the proper adapters, the switcher can be used with DVI digital video signals.

6. INPUTS- 1, 2, 3 & 4 HDMI: Connects a HDMI signal direct digital video/audio to the female HDMI connector. This connector supports HDMI digital video/audio and DVI digital video sources. HDMI Digital Video/Audio. Connectors with fix screws. Input 1 ~ Input 4

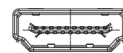

HDMI DIGITAL VIDEO/AUDIO CONNECTOR:

HDMI female connector.
Note: With the proper adapters, the switcher can be used with DVI digital video signals and is HDCP compliant. DVI does not support audio.

7. OUTPUTS- 1, 2, 3, 4, 5, 6, 7 & 8 HDMI: Connect a signal link of HDMI direct digital video/audio to this Female HDMI connector. This connector supports HDMI digital video/audio and DVI digital video sources. HDMI Digital Video/Audio. Connectors with fix screws. Output 1 ~ Output 8



HDMI DIGITAL VIDEO/AUDIO CONNECTOR:

HDMI female connector.
Note: With the proper adapters, the switcher can be used with DVI digital video signals HDCP compliant.

If you remove the HDMI screw posts, you must use the provided HDMI Locking Post replacement screws to keep the internal HDMI jack secure. Removing the HDMI screws without installing the HDMI Locking Post replacement screws will void your warranty.

REMOTE CONTROL

BEFORE MAKING ANY CONNECTIONS OBSERVE THE FOLLOWING:

- Ensure the main voltage supply matches the label on the supplied plug-pack (+/-10%).
- Ensure that the power switch is OFF.
- Ensure that all system grounds (earth) are connected to a common point.
- Avoid powering equipment within a system from multiple power sources that may be separated by large distances.
- Connect all audio video sources and destination equipment.
- Power up all source and destination audio-visual sources.
- For each destination output select the appropriate input source by using the front panel input select buttons. The supplied IR remote control. Or through the RS-232 serial communications port.
- Upon powering up the switcher, it will return to its last used setting before being powered down.

REMOTE CONTROL

1. & 2. SWITCH POWER ON or OFF:

Power ON and OFF

3. DESTINATION: 1 THRU 8 OUTPUT SELECTION:

Destination button to select the output display channel

4. SOURCE: 1 THRU 4 INPUT SOURCE SELECTION:

Input 1~4 source selection buttons

5. FUNCTION KEY: Function selection buttons

ALL	OFF	EDID	RECALL
MEMORY	ENTER	LOCK	

IR REMOTE : SW-5648

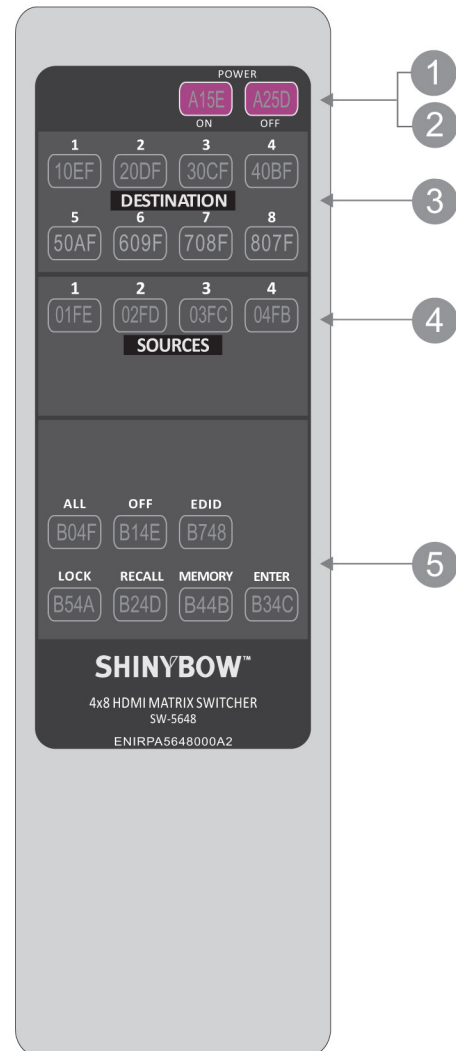

REMOTE PROTOCOL COMMANDS

IR REMOTE CUSTOM AND DATA CODES (NEC Standard)

HOW TO SETUP IR CODES :

CUSTOM CODE : 1DE2

DATA CODE :

POWER ON:	1DE2	A15E	LOCK:	1DE2	B54A
POWER OFF:	1DE2	A25D	RECALL:	1DE2	B24D
ALL:	1DE2	B04F	MEMORY:	1DE2	B44B
OFF:	1DE2	B14E	ENTER:	1DE2	B34C
EDID:	1DE2	B748			

PRESS TV DESTINATION - # then PRES AV SOURCE - #

DESTINATION #1 : 1DE2 10EF	SOURCE #1 : 1DE2 01FE
DESTINATION #2 : 1DE2 20DF	SOURCE #2 : 1DE2 02FD
DESTINATION #3 : 1DE2 30EF	SOURCE #3 : 1DE2 03FC
DESTINATION #4 : 1DE2 40BF	SOURCE #4 : 1DE2 04FB
DESTINATION #5 : 1DE2 50AF	
DESTINATION #6 : 1DE2 609F	
DESTINATION #7 : 1DE2 708F	
DESTINATION #8 : 1DE2 807F	

For Example:

Select Destination # 1 to show Source #1~4

The IR Data Code list :

Destination # 1, Source #1	1DE2 10EF 1DE2 01FE
Destination # 1, Source #2	1DE2 10EF 1DE2 02FD
Destination # 1, Source #3	1DE2 10EF 1DE2 03FC
Destination # 1, Source #4	1DE2 10EF 1DE2 04FB

RS-232 & ETHERNET SERIAL INTERFACE

RS-232 SERIAL INTERFACE CONNECT a PC or CONTROL SYSTEM. VERSION COMPATIBLE V2.0

For a complete list of commands, please reference external document extended RS-232 Protocol Instruction Manual.

Example of the commanded string to route Input 3 to Output 4

OUTPUT04 03;

RS-232 Pin Diagram

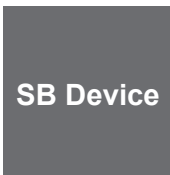
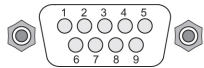

RS-232 CONFIGURATION

RS-232 cable is a straight thru cable and not null-modem

Definition	Pin		Pin	Definition
	1		1	DCD
TX	2	=====	2	RX
RX	3	=====	3	TX
	4		4	DTR
GND	5	=====	5	GND
	6		6	DSR
	7		7	RTS
	8		8	CTS
	9		9	RI



RS-232 SERIAL INTERFACE PROTOCOL COMMANDS (RS232 Control driver V2.0)

The Shinybow switcher can be controlled via the RS-232 serial control port to allow for interfacing to a PC, or similar third party control system. The serial communication parameters are 9600 baud, 8 bit, No Parity and 1 stop bit - this is often referred to as 9600 8N1. When the unit recognizes a complete command it will perform the requested action - there is no delimiter character required.

ETHERNET SERIAL INTERFACE CONNECT a PC or CONTROL SYSTEM. VERSION COMPATIBLE V1.0

ETHERNET SERIAL INTERFACE

Pin	Ethernet	Reference
1	TXOP	TX +
2	TXON	TX -
3	RXIP	RX +
4	NC	
5	NC	
6	RXIN	RX -
7	NC	
8	GND	

Ethernet

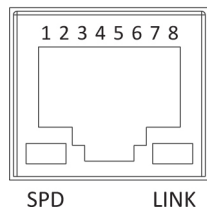

Note :
Control the switcher
SPD : Speed
LINK : Ethernet link
RJ-45 Female 8P-8 Connector

For a complete list of commands, please reference external document extended Ethernet Protocol Instruction Manual.

Example of the commanded string to route Input 3 to Output 4

OUTPUT04 03;

ETHERNET TCP/IP PROTOCOL COMMANDS (Ethernet V1.0)



*** The Ethernet port and RS-232 port cannot be used simultaneously. Any connection to the Ethernet Control port will disable serial commands send to the RS-232 port.***

EDID FUNCTION

EDID FUNCTION SETUP







EDID SETUP	To Change The EDID Setup
Step 1. Press the EDID button	The display will show the currently selected EDID mode.
Step 2. Press SOURCE #1 OR #2 button row	The button will flash blue and the display will show the current Embedded EDID Status.
Step 3. Press the ENTER button	To set EDID mode. The switcher will return to operation mode.
Operation will abort if no keys are pressed within 5 seconds.	
EMBEDDED EDID MODES	Total 7 EDID Modes
Embedded EDID Setup Press EDID > SOURCE > ENTER SOURCE #1 or SOURCE #2 	To select EDID mode. Repeatedly pressing the SOURCE 1 button will cycle up thru the options. Repeatedly pressing the SOURCE 2 button will cycle down thru the options. Embedded EDID: Mode 1 : FSS® Mode 2 : H24-3D Mode 3 : H24M-3D Mode 4 : H36-3D Mode 5 : H36-3D-M (1080p-36 bits) Mode 6 : 4K2K (24/30Hz) Mode 7 : 1920x1200-60Hz (DVI-D)

EDID FUNCTION FOR HDMI MATRIX SWITCHER

RESET	EDID Return To Factory Default
How to RESET EDID mode Press EDID > RECALL > ENTER  	To RESET to FACTORY DEFAULT (1080p-2CH). Press EDID button: The LCM will show the current EDID status. Press RECALL button: The LCM will show the RESET EDID . Press ENTER to confirm entries. The EDID will return to FSS® mode and resolution 1080p-2CH.
EDID STATUS	To View The Current EDID Status
Step 1. Press EDID button	The button will flash blue and the display will show the current Embedded EDID Status.
Step 2. Press EDID button	To exit.
HOW TO SETUP FSS® FUNCTION	Fast Speed Start®
Step 1. Press the DESTINATION #1-4 button row Then Press the SOURCE #1-4 button row	To setup and Install all devices.
Step 2. Press EDID button	Select a optimum status of Embedded EDID mode.
Step 3. Press ENTER button	To confirm entries.
Step 4. Press EDID button	To select the EDID FSS® mode.
Step 5. Press ENTER button	To confirm entries.

EDID FUNCTION

EDID FUNCTION: (7) EMBEDDED EDID MODES

EDID FUNCTION: (7) EMBEDDED EDID MODES	
Mode 1. FSS® (Fast Speed Start®) 	Fast Speed Start® mode shortens the startup time of the switcher. Selecting this mode does not force the EDID setup to be cancelled. Users may first select one EDID mode from mode 2 to 3, and then select mode 1 for fast speed start®.
Mode 2. H24-3D (1080p-24 bits) 	Audio Support: PCM 2CH
Mode 3. H24-3D-M (1080p-24bits) 	Audio Support: MAT(MLP) 7.1CH, PCM 2CH, One Bit Audio 2CH, AC-3 5.1CH, DTS 5.1CH, PCM 7.1CH, Dolby Digital + 7.1CH, DTS-HD 7.1CH
Mode 4. H36-3D (1080p-36 bits) 	Audio Support: PCM 2CH
Mode 5. H36-3D-M (1080p-36 bits) 	Audio Support: MAT(MLP) 7.1CH, PCM 2CH, One Bit Audio 2CH, AC-3 5.1CH, DTS 5.1CH, PCM 7.1CH, Dolby Digital + 7.1CH, DTS-HD 7.1CH
Mode 6. 4K2K (24/30Hz) 	HDMI Support: 4K2K-3D, PCM 2CH (3860x2160-24/30Hz) Audio Support: PCM 2CH
Mode 7. 1920x1200-60Hz (DVI-D) 	DVI Support: DVI-D 1920 x 1200 60Hz

EDID FUNCTION

EDID FUNCTION FOR HDMI MATRIX SWITCHER

LEARNING EDID	Learning EDID From Destination To Source
<p>Learning EDID setup Press EDID > DESTINATION > SOURCE > ENTER</p> 	<p>Press EDID > DESTINATION Button The LCM will be show LEARNING. The switcher will LEARN destination HDMI EDID and pass the selected source. Learning EDID setup for HDMI Key Sequence: EDID > DESTINATION # > SOURCE # > ENTER The EDID for HDMI has been learned</p>
<p>NOTE: The already learned EDID cannot be modified. You can only rebuild a new Learning EDID.</p> <p>For Example: When the Source has “Learned” the EDID data from a destination, It will save that EDID information into EPROM and the EDID data cannot change.</p> <p>Please select new learning destination to sources or change to one of the embedded EDID modes when you want to remove the learning EDID memory from EPRPM.</p>	
LEARNING EDID SINGLE TO SINGLE	Learning Destination #2 EDID To Source #3
<p>Step 1. Press EDID button</p>	<p>The button will flash blue and the display will show the current Embedded EDID Status.</p>
<p>Step 2. Press the DESTINATION #2 button row</p>	<p>Copy the Destination #2 Display EDID.</p>
<p>Step 3. Press the SOURCE #3 button row</p>	<p>Learning the Destination #2 EDID To Source # 3.</p>
<p>Step 4. Press ENTER button</p>	<p>To confirm entries.</p>
LEARNING EDID SINGLE TO MULTIPLE	Learning Destination EDID Link To The Majority Sources
<p>Step 1. Press EDID button</p>	<p>The button will flash blue and the display will show the current Embedded EDID Status.</p>
<p>Step 2. Press the DESTINATION #2 button row</p>	<p>Copy any 1~8 Destinations EDID.</p>
<p>Step 3. Press the SOURCE 1-4 button row</p>	<p>Learning the Destination EDID link to source 1-4.</p>
<p>Step 4. Press ENTER button</p>	<p>To confirm entries.</p>
LEARNING EDID SINGLE TO ALL	Learning Destination EDID Link To All Sources
<p>Step 1. Press EDID button</p>	<p>The button will flash blue and the display will show the current Embedded EDID Status.</p>
<p>Step 2. Press destination button 1 THRU 8</p>	<p>Learning anyone 1~8 Destination EDID to all sources.</p>
<p>Step 3. Press ALL button</p>	<p>Learning selected destination EDID to all sources.</p>
<p>Step 4. Press ENTER button</p>	<p>To confirm entries.</p>
SINGLE LEARNING #1 DEFINITION	Single Learning EDID From Destination To Source
<ol style="list-style-type: none"> The switcher will LEARN the destination EDID and pass to the selected source. To set up learning between a single destination and single source: Press EDID button > Press DESTINATION 1 THRU 8 > Press SOURCE 1 THRU 4 > Press ENTER to confirm. The switcher will learn the destination EDID for the source device. To set up learning between a single destination and multiple sources: Press EDID button > Press DESTINATION 1 THRU 8 > Press the majority SOURCES 1 THRU 4 > Press ENTER. The switcher will learn the single destination EDID to many source devices. How to Learn single destinations with all sources. Press EDID button > Press ALL button > Press ENTER to confirm. 	
MULTIPLE LEARNING #2 DEFINITION	Multiple Learning EDID From Destination To Source
<ol style="list-style-type: none"> The switcher will LEARN multiple destination EDID and pass to the selected source. To set up multiple learning between a multiple destinations and multiple source: Press EDID button > Press OFF button > Press Destination 1 THRU 8 > Press ENTER to confirm. Switcher will learn destination EDIDs to the source devices. When the Source has “Learned” the EDID data from a destination, it will save that EDID information into EPROM and the EDID data will not change. To change a saved HDMI EDID information, you have to select a new LEARNING destination to source or Disable the LEARNING. 	

IR EXTENDER

1. SB-100 IR 300M Receiver

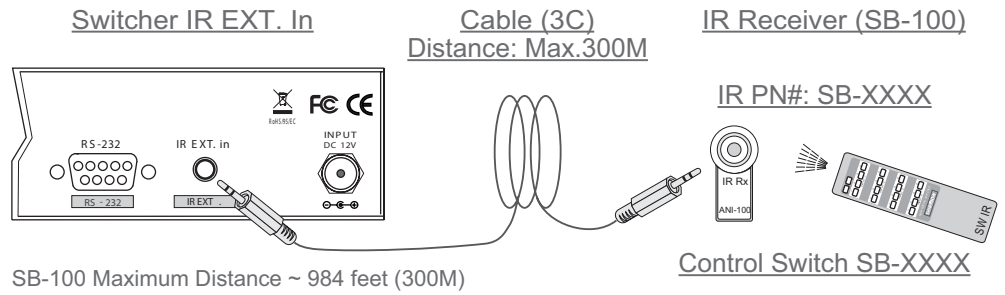

The SB-100 IR Receiver is required when using the port "ALL in" Jack.

2. SB-100C IR 2M Receiver

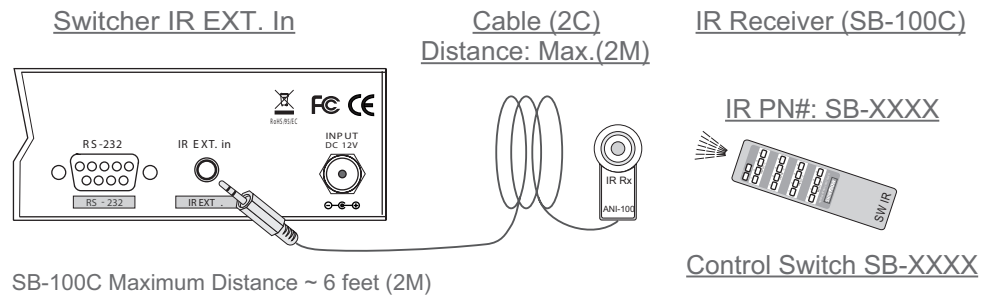

The SB-100C IR Receiver will not function on the port "ALL in" Jack.

*** When you plug the External IR extender into the switcher, the front panel IR receiver remains active. ***

Pin configuration for IR 984 feet (300M) Extender Receiver such as SB-100 compatible

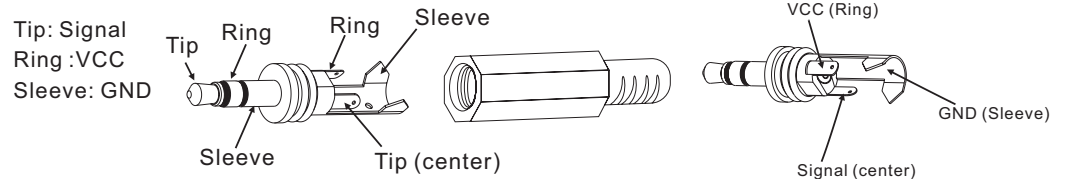

SB-100 Receiver and SB-101 Transmitter The DISTANCE maximum ~ 984 feet (300M)

Pin configuration for IR Receiver 6 feet (2M) cable such as SB-100C compatible

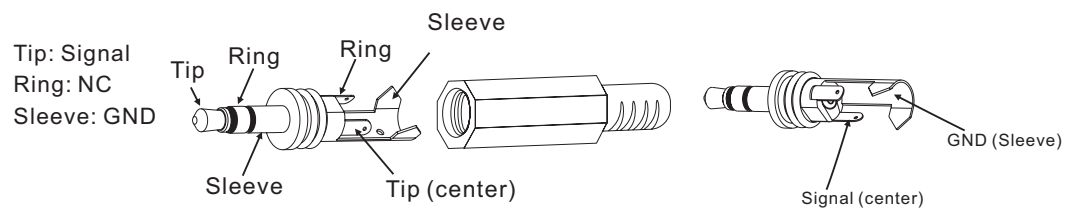

SB-100 Receiver and SB-101C Transmitter The DISTANCE maximum ~ 984 feet (300M)

Note: The External IR jack has voltage on the "Ring" portion of a 3-conductor plug. You must use a 3-conductor plug (aka: stereo plug). Using a 2-conductor plug will short out the power supply. Always make connections with the switcher power off.

TYPICAL APPLICATION

INSTALLING DIAGRAM

Sample Connection: Using RS-232 serial interface or Ethernet TCP/IP to control switch (SB-5648K) and preview output port simultaneously via Output-#1 to extra HDMI HDTV, Display or Monitor.

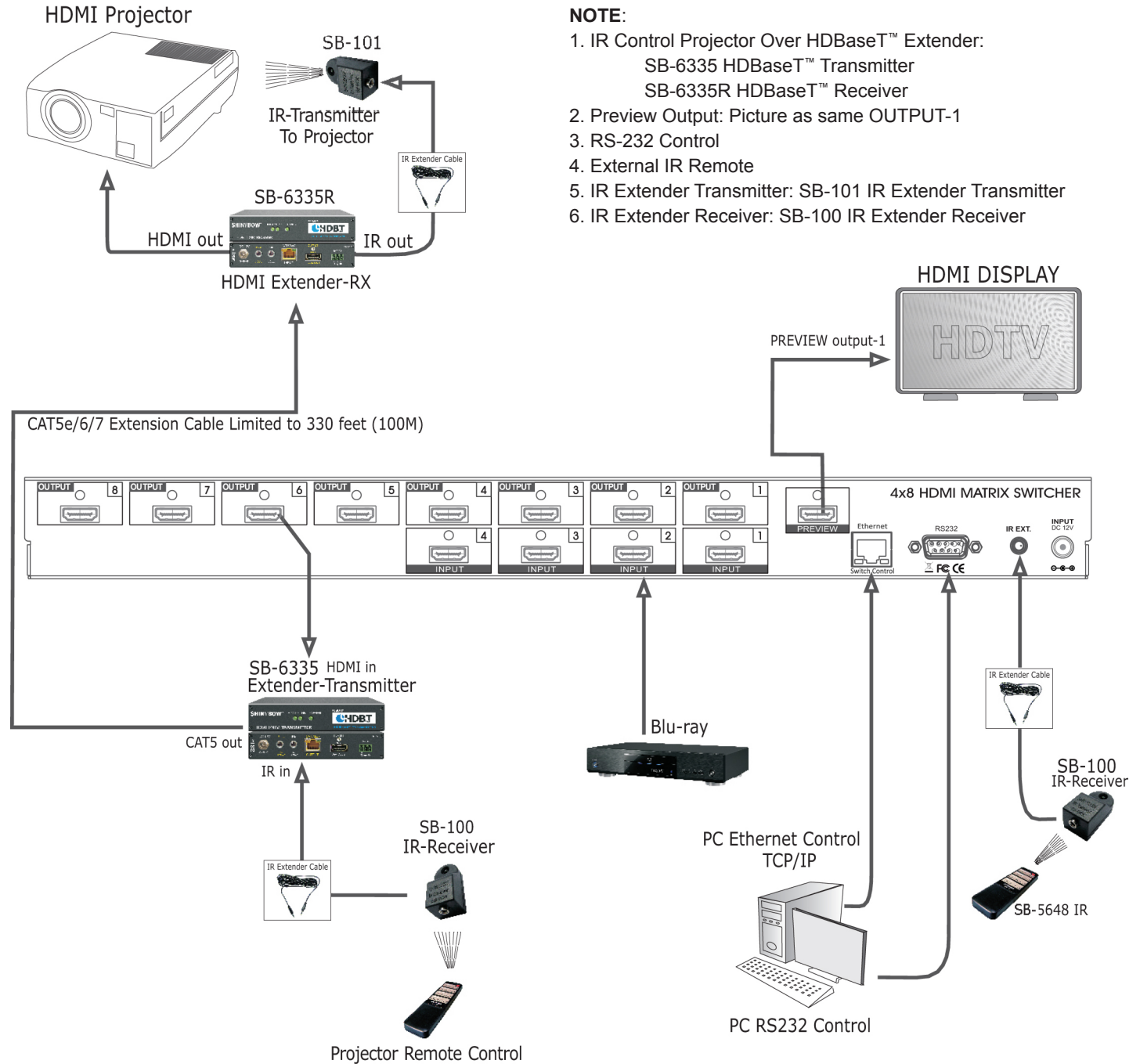

NOTE:

1. IR Control Projector Over HDBaseT™ Extender:
SB-6335 HDBaseT™ Transmitter
SB-6335R HDBaseT™ Receiver
2. Preview Output: Picture as same OUTPUT-1
3. RS-232 Control
4. External IR Remote
5. IR Extender Transmitter: SB-101 IR Extender Transmitter
6. IR Extender Receiver: SB-100 IR Extender Receiver

Supports the HDBaseT™ Extender by SB-6335 Transmitter and SB-6335R Receiver via a CAT5e/6/7 cable.

LIMITED WARRANTY

PLEASE READ THE FOLLOWING TERMS AND CONDITIONS CAREFULLY BEFORE USING THIS HARDWARE, COMPONENTS AND SOFTWARE PROVIDED BY, THROUGH OR UNDER SHINYBOWUSA, INC (COLLECTIVELY, THE "PRODUCT"). By using installing or using the Product, you unconditionally signify your agreement to these Terms and Conditions. If you do not agree to these Terms and Conditions, do not use the Product and return the Product to SHINYBOWUSA, Inc. at the return address set forth on the Product's packing label at your expense. SHINYBOWUSA, Inc. may modify these Terms and Conditions at anytime, without notice to you.

RESTRICTIONS ON USE OF THE PRODUCT

It is your responsibility to read and understand the installation and operation instructions, both verbal and in writing, provided to you with respect to the Product. You are authorized to use the Product solely in connection with such instructions. Any use of the Product not in accordance with such instructions shall void any warranty pertaining to the Product. Any and all damages that may occur in the use of the Product that is not strictly in accordance with such instructions shall be borne by you and you agree to indemnify and hold harmless SHINYBOWUSA, Inc. from and against any such damage.

The Product is protected by certain intellectual property rights owned by or licensed to SHINYBOWUSA. Any intellectual property rights pertaining to the Product are licensed to you by SHINYBOWUSA, Inc. and/or its affiliates, including any manufacturers or distributors of the Product (collectively, "SHINYBOWUSA") for your personal use only, provided that you do not change or delete any proprietary notices that may be provided with respect to the Product.

The Product is sold to you and any use of any associated intellectual property is deemed to be licensed to you by SHINYBOWUSA for your personal use only. SHINYBOWUSA does not transfer either the title or the intellectual property rights to the Product and SHINYBOWUSA retains full and complete title to the intellectual property rights therein. All trademarks and logos are owned by SHINYBOWUSA or its licensors and providers of the Product, and you may not copy or use them in any manner without the prior written consent of SHINYBOWUSA, which consent may be withheld at the sole discretion of SHINYBOWUSA.

The functionality and usability of the Product is controlled by SHINYBOWUSA, Inc. from its offices within the State of Texas, United States of America. SHINYBOWUSA makes no representation that materials pertaining to the Product are appropriate or available for use in other locations other than the shipping address you provided with respect thereto. You are advised that the Product may be subject to U.S. export controls.

DISCLAIMERS AND LIMITATION OF LIABILITY

SHINYBOWUSA may change or modify the Product at any time, from time to time.

THE PRODUCT IS PROVIDED "AS IS" AND WITHOUT WARRANTIES OF ANY KIND EITHER EXPRESS OR IMPLIED. SHINYBOWUSA DOES NOT WARRANT OR MAKE ANY REPRESENTATIONS REGARDING THE USE OR THE RESULTS OF THE USE OF THE PRODUCT'S CORRECTNESS, ACCURACY, RELIABILITY, OR OTHERWISE.

SHINYBOWUSA has no duty or policy to update any information or statements pertaining to the Product and, therefore, such information or statements should not be relied upon as being current as of the date you use the Product. Moreover, any portion of the materials pertaining to the Product may include technical inaccuracies or typographical errors. Changes may be made from time to time without notice with respect to the Product.

TO THE FULLEST EXTENT PERMISSIBLE PURSUANT TO APPLICABLE LAW, SHINYBOWUSA DISCLAIMS ALL WARRANTIES, EXPRESS OR IMPLIED, INCLUDING, BUT NOT LIMITED TO IMPLIED WARRANTIES OF MERCHANTABILITY, FITNESS FOR A PARTICULAR PURPOSE AND NON-INFRINGEMENT. SHINYBOWUSA DOES NOT WARRANT THE ACCURACY, COMPLETENESS OR USEFULNESS OF ANY INFORMATION WITH RESPECT TO THE PRODUCT. SHINYBOWUSA DOES NOT WARRANT THAT THE FUNCTIONS PERTAINING TO THE PRODUCT WILL BE ERROR-FREE, THAT DEFECTS WITH RESPECT TO THE PRODUCT WILL BE CORRECTED, OR THAT THE MATERIALS PERTAINING THERETO ARE FREE OF DEFECTS OR OTHER HARMFUL COMPONENTS. SHINYBOWUSA WILL USE ITS REASONABLE EFFORTS TO CORRECT ANY DEFECTS IN THE PRODUCT UPON TIMELY WRITTEN NOTICE FROM YOU NOT TO EXCEED 10 BUSINESS DAYS AFTER RECEIPT BY YOU OF THE PRODUCT, BUT YOU (AND NOT SHINYBOWUSA) ASSUME THE ENTIRE COST OF ALL NECESSARY SERVICING, REPAIR AND CORRECTION THAT WAS CAUSED BY YOU UNLESS OTHERWISE AGREED TO IN A SEPARATE WRITING BY SHINYBOWUSA.

UNDER NO CIRCUMSTANCES, INCLUDING, BUT NOT LIMITED TO, NEGLIGENCE, SHALL SHINYBOWUSA BE LIABLE FOR ANY SPECIAL OR CONSEQUENTIAL DAMAGES THAT RESULT FROM THE USE OF, OR THE INABILITY TO USE THE PRODUCT IN ACCORDANCE WITH ITS SPECIFICATIONS, EVEN IF SHINYBOWUSA OR ITS REPRESENTATIVES HAVE BEEN ADVISED OF THE POSSIBILITY OF SUCH DAMAGES. IN NO EVENT SHALL SHINYBOWUSA'S TOTAL LIABILITY TO YOU FROM ALL DAMAGES, LOSSES, AND CAUSES OF ACTION (WHETHER IN CONTRACT, OR OTHERWISE) EXCEED THE AMOUNT YOU PAID TO SHINYBOWUSA, IF ANY, FOR THE PRODUCT.

END OF DOCUMENT

122 Rose Ln. Suite 303 | Frisco, Texas 75034

1-877-SHINY-USA

1-877-744-6987

1-972-377-2508

sales@shinybowusa.com

www.shinybowusa.com

SHINYBOW™ USA
MULTIMEDIA AUDIO AND VISUAL