



**THE DISPLAY CHOICE
OF PROFESSIONALS™**

MD-2402 & MD-2702 LCD Monitor

User Manual

www.agneovo.com

TABLE OF CONTENTS

SAFETY INFORMATION

WEEE	4
------------	---

PRECAUTIONS

Notice	5
Cautions When Setting Up	5
Cautions When Using	6
Cleaning and Maintenance	7
Notice for the LCD Monitor	7

CHAPTER 1: PRODUCT DESCRIPTION

1.1 Package Contents	8
1.2 Installation	9
1.2.1 Installing the Stand	9
1.2.2 Adjusting the Viewing Angle and Height	10
1.2.3 Wall Mounting	11
1.3 Overview	12
1.3.1 Control Panel and Indicator	12
1.3.2 Rear View	13

CHAPTER 2: MAKING CONNECTIONS

2.1 Connecting the AC Power	14
2.2 Connecting Input Source Signals	15

CHAPTER 3: USING THE LCD MONITOR

3.1 Turning on the Power	16
3.2 Selecting a Source	16
3.3 Using Auto Adjustment Function	17
3.4 Selecting the Picture Mode	17
3.5 Displaying the OSD Menu	18
3.6 Locking the OSD Menu	18

CHAPTER 4: ON SCREEN DISPLAY MENU

4.1 Using the OSD Menu	20
4.2 OSD Menu Tree	21

CHAPTER 5: ADJUSTING THE LCD MONITOR

5.1 Brightness Setting	22
5.2 Image Setup Setting	24
5.3 Colour Temperature Setting	25
5.4 OSD Setting	26
5.5 System Setting	27

CHAPTER 6: APPENDIX

6.1 Warning Messages	28
6.2 Timing	29
6.3 Troubleshooting	30
6.4 Transporting the LCD Monitor	31

TABLE OF CONTENTS

CHAPTER 7: SPECIFICATIONS

7.1 Monitor Specifications	33
7.2 Monitor Dimensions.....	34
7.2.1 MD-2402 Dimensions.....	34
7.2.2 MD-2702 Dimensions.....	35

SAFETY INFORMATION

WEEE

Information for users applicable in European Union countries

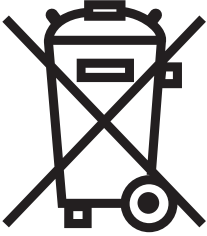

The symbol on the product or its packaging signifies that this product has to be disposed separately from ordinary household wastes at its end of life. Please kindly be aware that this is your responsibility to dispose electronic equipment at recycling centers so as to help conserve natural resources. Each country in the European Union should have its collection centers for electrical and electronic equipment recycling. For information about your recycling drop off area, please contact your local related electrical and electronic equipment waste management authority or the retailer where you bought the product.

PRECAUTIONS

PRECAUTIONS

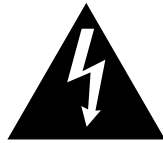

Symbols used in this manual



This icon indicates the existence of a potential hazard that could result in personal injury or damage to the product.



This icon indicates important operating and servicing information.

Notice

- Read this User Manual carefully before using the LCD monitor and keep it for future reference.
- The product specifications and other information provided in this User Manual are for reference only. All information is subject to change without notice. Updated content can be downloaded from our web site at www.agneovo.com.
- To protect your rights as a consumer, do not remove any stickers from the LCD monitor. Doing so may affect the determination of the warranty period.

Cautions When Setting Up



Do not place the LCD monitor near heat sources, such as a heater, exhaust vent, or in direct sunlight.



Do not cover or block the ventilation holes in the housing.



Place the LCD monitor on a stable area. Do not place the LCD monitor where it may be subject to vibration or shock.



Place the LCD monitor in a well-ventilated area.



Do not place the LCD monitor outdoors.



Do not place the LCD monitor in a dusty or humid environment.



Do not spill liquid or insert sharp objects into the LCD monitor through the ventilation holes. Doing so may cause accidental fire, electric shock or damage the LCD monitor.

PRECAUTIONS

Cautions When Using



Use only the power cord supplied with the LCD monitor.



The power outlet should be installed near the LCD monitor and be easily accessible.



If an extension cord is used with the LCD monitor, ensure that the total current consumption plugged into the power outlet does not exceed the ampere rating.



Do not allow anything to rest on the power cord. Do not place the LCD monitor where the power cord may be stepped on.



If the LCD monitor will not be used for an indefinite period of time, unplug the power cord from the power outlet.



To disconnect the power cord, grasp and pull by the plug head. Do not tug on the cord; doing so may cause fire or electric shock.



Do not unplug or touch the power cord with wet hands.



WARNING:

Unplug the power cord from the power outlet and refer to qualified service personnel under the following conditions:



- When the power cord is damaged.
- If the LCD monitor has been dropped or the housing has been damaged.
- If the LCD monitor emits smoke or a distinct odor.



Ceiling mount or mount on any other horizontal surface overhead are not advisable.



WARNING:

Installation in contravention of the instructions may result in undesirable consequences, particularly hurting people and damaging property. Users who have already mounted the monitor on the ceiling or any other horizontal surface overhead are strongly advised to contact AG Neovo for consultations and solutions to help ensure a most pleasurable and fulfilling monitor experience.

PRECAUTIONS

Cleaning and Maintenance



Do not attempt to service the LCD monitor yourself, refer to qualified service personnel.

Opening or removing the covers may expose you to dangerous voltage or other risks.

Notice for the LCD Monitor

In order to maintain the stable luminous performance, it is recommended to use low brightness setting.

Due to the lifespan of the lamp, it is normal that the brightness quality of the LCD monitor may decrease with time.

When static images are displayed for long periods of time, the image may cause an imprint on the LCD monitor. This is called image retention or burn-in.

To prevent image retention, do any of the following:

- Set the LCD monitor to turn off after a few minutes of being idle.
- Use a screen saver that has moving graphics or a blank white image.
- Switch desktop backgrounds regularly.
- Adjust the LCD monitor to low brightness settings.
- Turn off the LCD monitor when the system is not in use.

Things to do when the LCD monitor shows image retention:

- Turn off the LCD monitor for extended periods of time. It can be several hours or several days.
 - Use a screen saver and run it for extended periods of time.
 - Use a black and white image and run it for extended periods of time.
-

There are millions of micro transistors inside the LCD monitor. It is normal for a few transistors to be damaged and to produce spots. This is acceptable and is not considered a failure.

CHAPTER 1: PRODUCT DESCRIPTION

1.1 Package Contents

When unpacking, check if the following items are included in the package. If any of them is missing or damaged, contact your dealer.

LCD Monitor

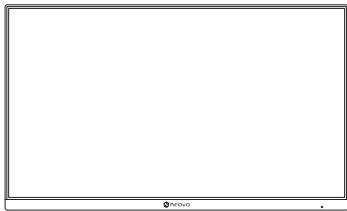

MD-2402

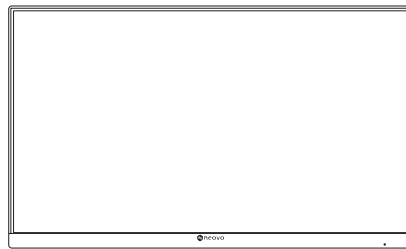

MD-2702

Stand and Screws

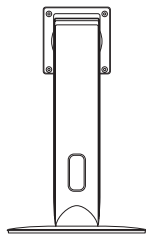



(M4 x 10 mm) *4pcs

Quick Start Guide

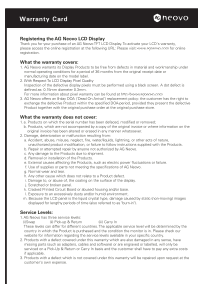

Warranty Card



Power Adapter

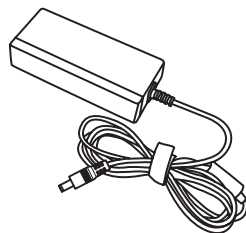

Power Cord

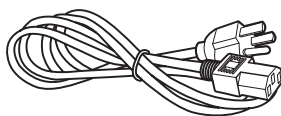

HDMI Cable

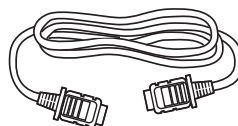

Note:

Must use only the supplied power adapter:

- ◆ Adaptor Technology
Model no.: ATM065T-P120
Rating: 12V/5A

Note:

- ◆ The pictures are for reference only. Actual items may vary upon shipment.

PRODUCT DESCRIPTION

1.2 Installation

1.2.1 Installing the Stand

1. Place the LCD monitor with the screen side down on a cushioned surface.
2. Attach the stand to the LCD monitor.
 - a. Align and attach the stand to the rear of the LCD monitor.
 - b. Use the screws to secure the stand.

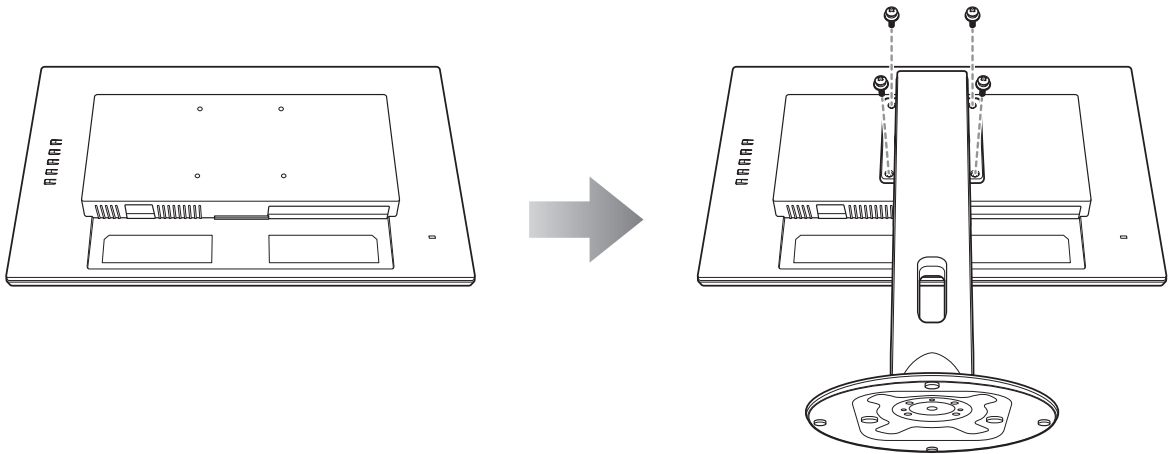

3. Set the LCD monitor up in an upright position.

PRODUCT DESCRIPTION

1.2.2 Adjusting the Viewing Angle and Height

For optimal viewing, it is recommended to look at the full face of the screen, then adjust the screen of the LCD monitor angle and height according to your preference.

Hold the stand so that the screen does not topple when you make the adjustment.

You are able to adjust the screen angle and height as below:

Tilt angle:

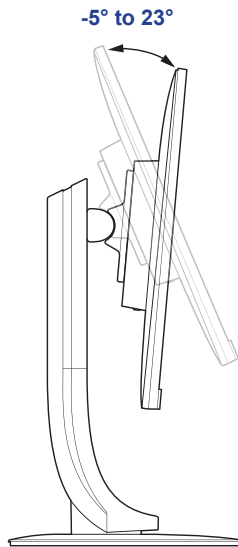

Pivot angle:

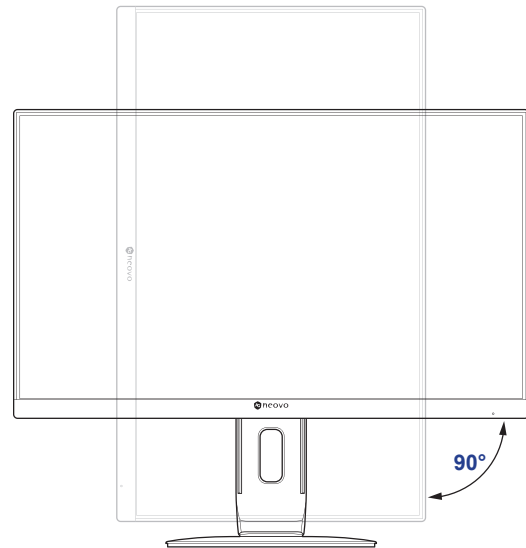

Note: Before making the adjustment, make sure to adjust the height to the highest position, and then tilt the screen 90°.

Swivel angle:

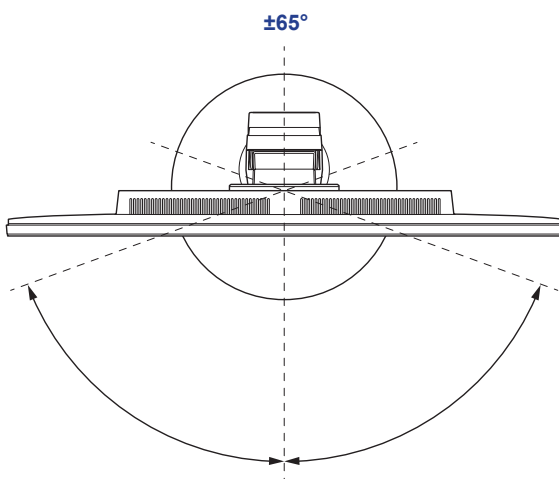

Height adjustment:

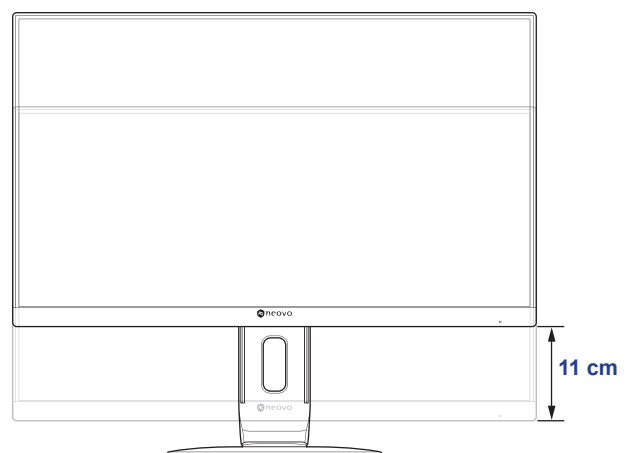

PRODUCT DESCRIPTION

1.2.3 Wall Mounting

To wall mount the LCD monitor, do the following steps:

1. Remove the stand.

Refer to page 31.

2. Wall mount the LCD monitor.

Screw the mounting bracket to the VESA holes at the rear of the LCD monitor.

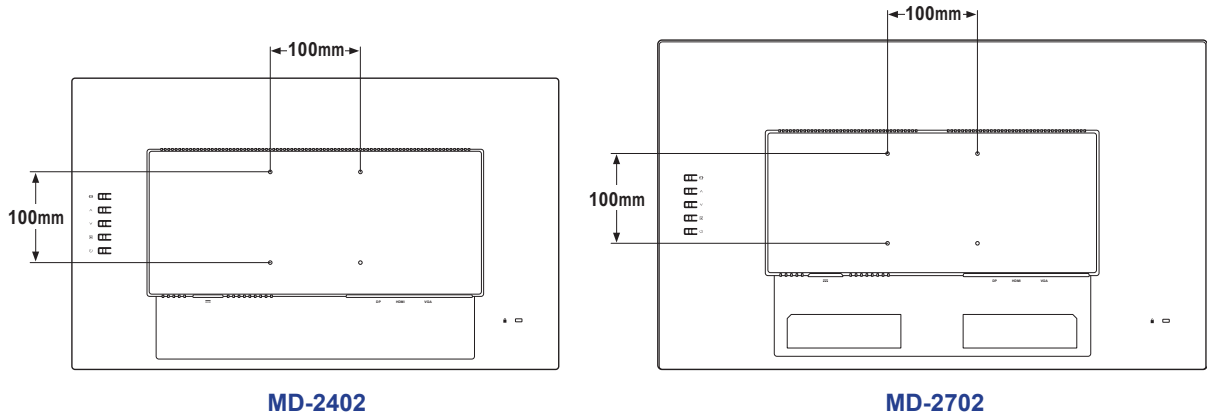

Note: Take measures to prevent the LCD monitor from falling down and lessen possible injury and damage to the monitor in case of earthquakes or other disasters.

- Use only the 100 x 100 mm wall mount kit recommended by AG Neovo. All AG Neovo wall mount kits comply with VESA standard.
- Secure the LCD monitor on a solid wall strong enough to bear its weight.
- It is suggested to wall mount the LCD monitor without tilting it facing downward.

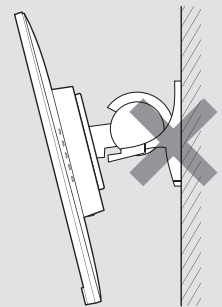

PRODUCT DESCRIPTION

1.3 Overview

1.3.1 Control Panel and Indicator

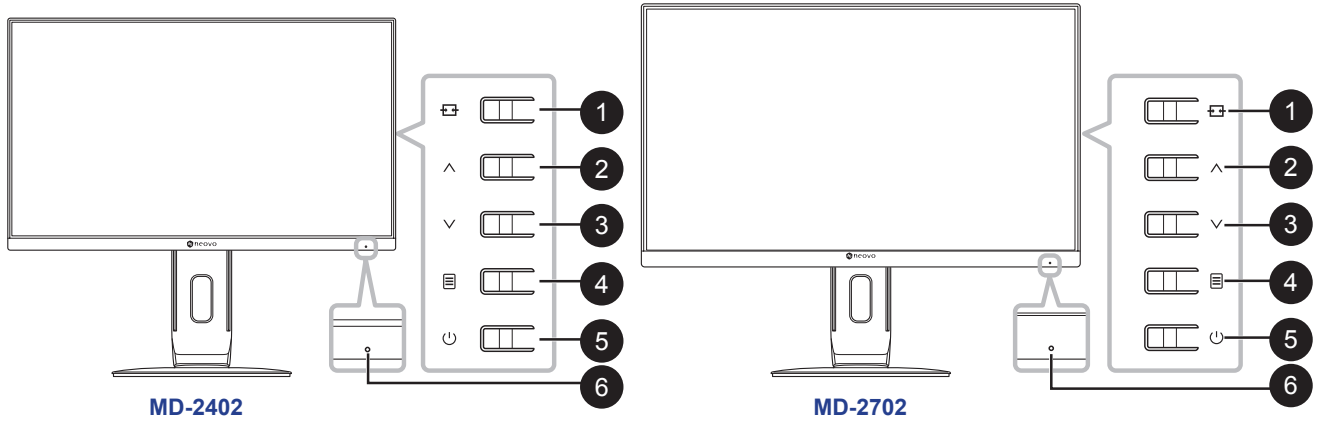

1

AUTO/SOURCE/EXIT (⌂): Hot Key: Source Key

- When OSD menu is OFF, press and hold the keypad keys listed below for at least 3 seconds to activate the Auto Adjustment function (for VGA input signal source).
- When OSD menu is OFF, press to select input when connecting input cable.
- When OSD menu is ON, press to exit the OSD menu.

2

UP (^):

When the OSD is ON, navigate through adjustment icons or adjust a function.

3

DOWN (v): Hot Key: PICTURE MODE Select

- When OSD menu is OFF, activate the PICTURE MODE Select.
- When OSD menu is ON, navigate through adjustment icons or adjust a function.

4

MENU/ENTER (≡):

Active OSD menu, function adjust confirm, or Exit OSD menu.

5

POWER (⏻):

Press to switch the display on or off.

6

Power status indicator: Indicates the operating status of the monitor:

- Blue – Power On mode.
- Blinking Blue – Standby mode.
- LED off – Off mode.

PRODUCT DESCRIPTION

1.3.2 Rear View

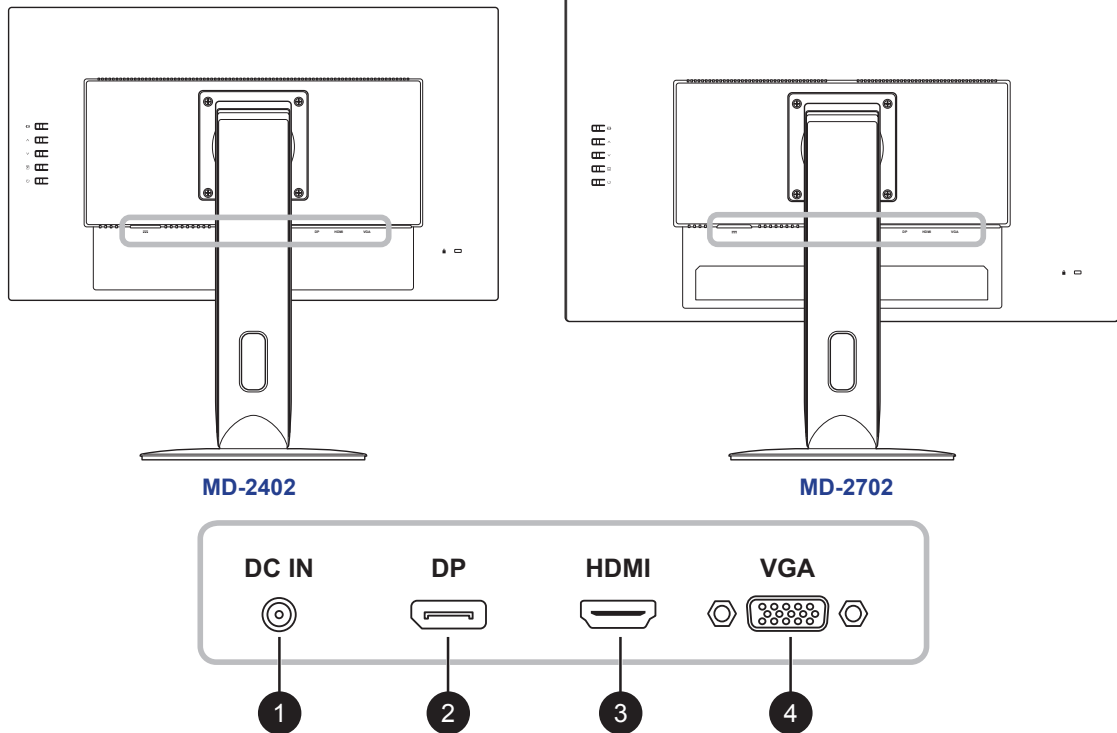

- 1 **DC IN:**
Connect with the supplied power adaptor.
- 2 **DisplayPort IN:**
Connect DisplayPort signals input.
- 3 **HDMI IN:**
Connect HDMI signals input.
- 4 **VGA IN:**
Connect VGA signals input.

CHAPTER 2: MAKING CONNECTIONS



CAUTION:

Make sure that the LCD monitor is not connected to the power outlet before making any connections. Connecting cables while the power is ON may cause possible electric shock or personal injury.

2.1 Connecting the AC Power

1. Connect the power cord to the power adapter.
2. Connect the power adapter to the DC power input at the rear of the LCD monitor.
3. Connect the power cord plug to a power outlet or a power supply.

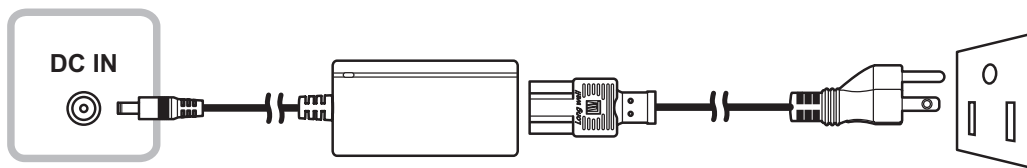

CAUTION:

When unplugging the power cord, hold the power cord by the plug head. Never pull by the cord.

MAKING CONNECTIONS

2.2 Connecting Input Source Signals

Input source signals can be connected with the following cables:

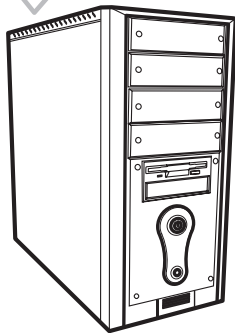
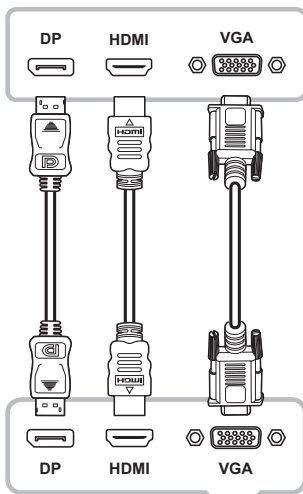

- **DisplayPort**

Connect one end of a DP cable to the DP connector of the LCD monitor and the other end to the DP connector of the computer.

- **HDMI**

Connect one end of an HDMI cable to the HDMI connector of the LCD monitor and the other end to the HDMI connector of the computer.

- **VGA**

Connect one end of a D-Sub (VGA) cable to the D-Sub (VGA) connector of the LCD monitor and the other end to the D-Sub (VGA) connector of the computer.

CHAPTER 3: USING THE LCD MONITOR

3.1 Turning on the Power

1. Connect the power adapter to the DC power input at the rear of the LCD monitor.
2. Connect the power cord plug to a power outlet or a power supply.
3. Press the  key on the control panel.

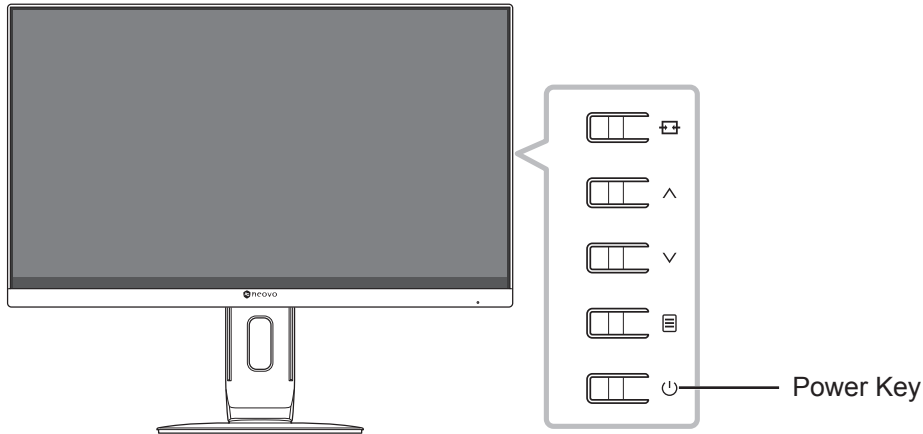

When the LCD monitor is turned on, press the  key to turn off the LCD monitor.

Note: The LCD monitor still consumes power as long as the power cord is connected to the power outlet. Disconnect the power adapter to completely cut off power.

3.2 Selecting a Source

Press the  key to call out the source selection menu.

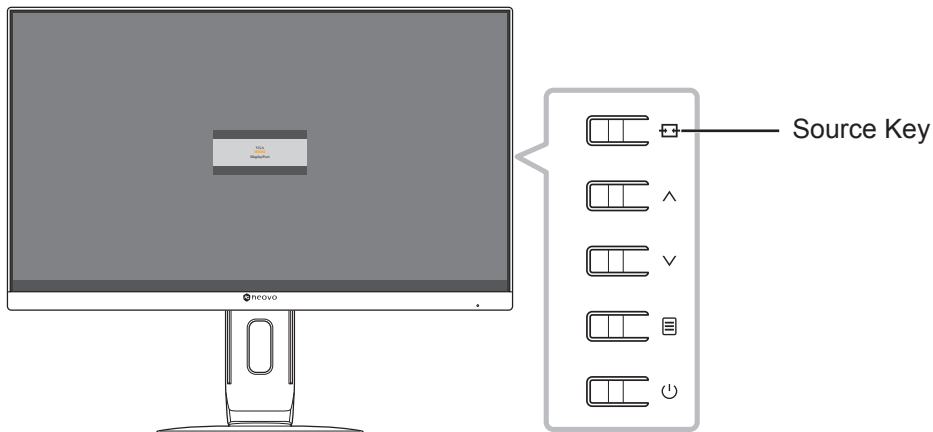

The following menu appears on the screen:



USING THE LCD MONITOR

3.3 Using Auto Adjustment Function

Press and hold the  key for at least 3 seconds to perform the auto adjustment for the VGA source. This function automatically tunes the LCD monitor to its optimal setting, including horizontal position, vertical position, clock, and phase.

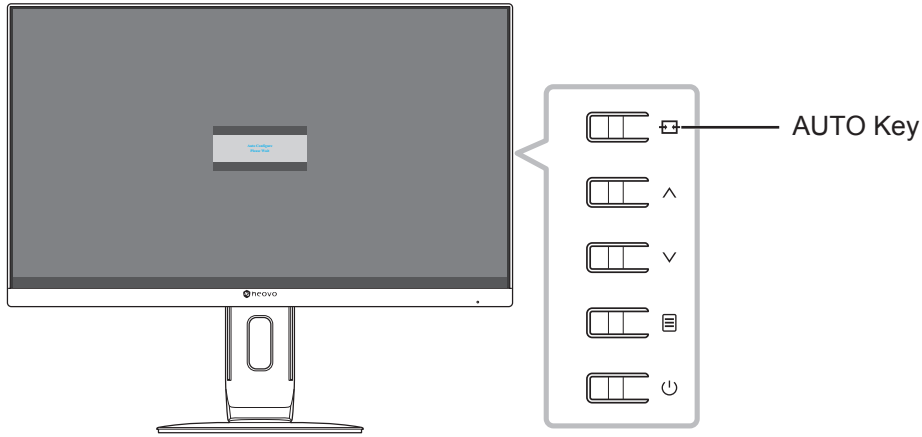

When the auto adjustment is initiated, the below message is displayed on the screen:



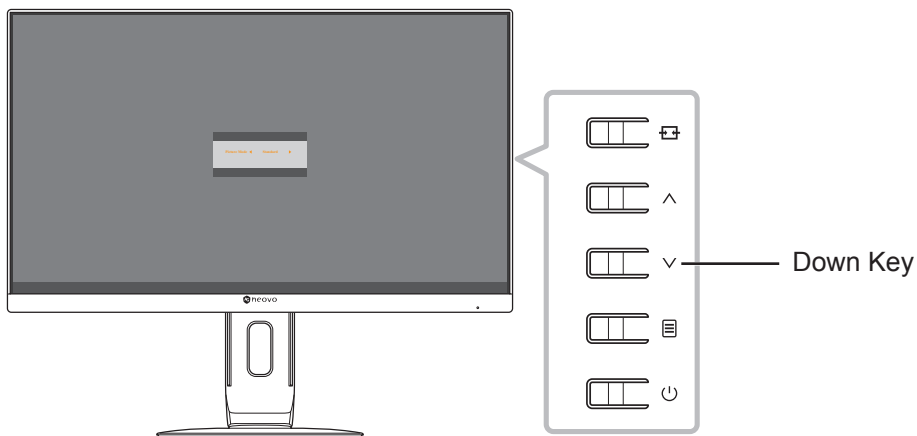

3.4 Selecting the Picture Mode

Press the  key to call out the picture mode menu.





The following menu appears on the screen:



Press the  or  key to select the picture mode. Then press the  key to confirm or wait until the picture mode menu disappears from the screen automatically. The available picture mode options include “Standard”, and “DICOM”.

USING THE LCD MONITOR

3.5 Displaying the OSD Menu

Press the  key to open the OSD menu. Press the  key to close the OSD menu.

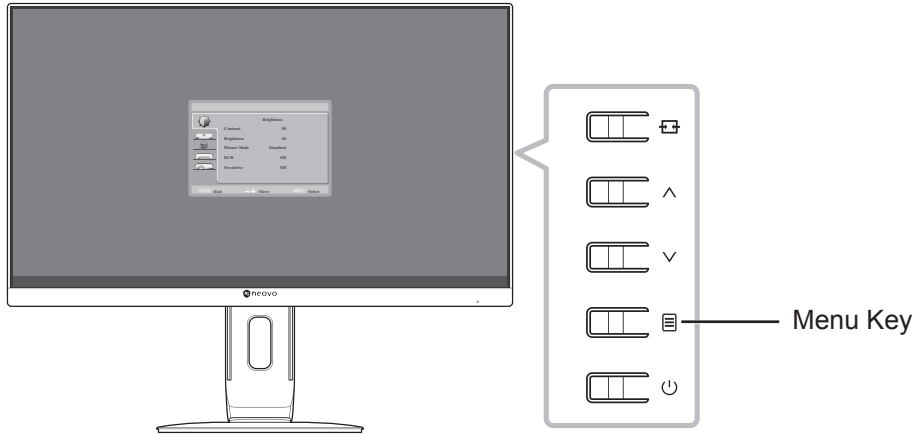

For more information on adjusting settings, refer to page 22.

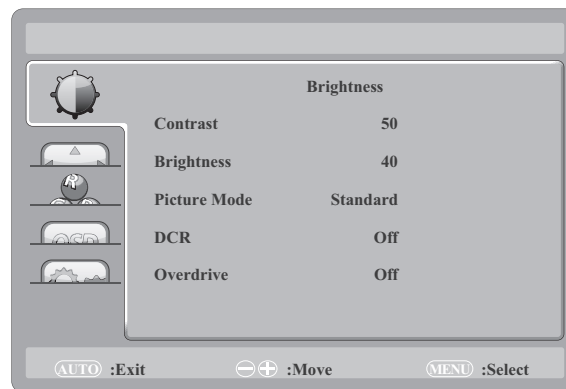

The following menu appears on the screen:



3.6 Locking the OSD Menu

To lock the OSD menu, press and hold the  key while the LCD monitor is off, and then press the  key to turn the LCD monitor on.

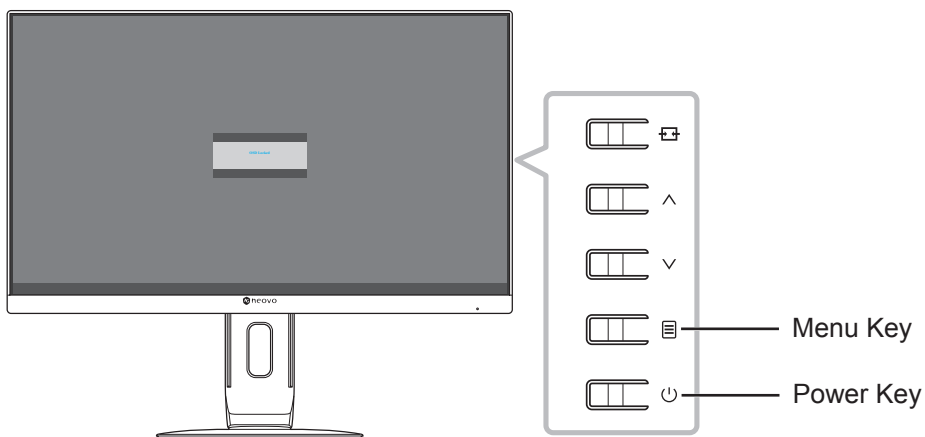

USING THE LCD MONITOR

The following menu appears on the screen when you press the \wedge , \vee , or \equiv key:



To unlock the OSD menu, press and hold the \equiv key while the LCD monitor is off, and then press the ⏻ key.

CHAPTER 4: ON SCREEN DISPLAY MENU

4.1 Using the OSD Menu

1. Press the  key to call out the OSD window.

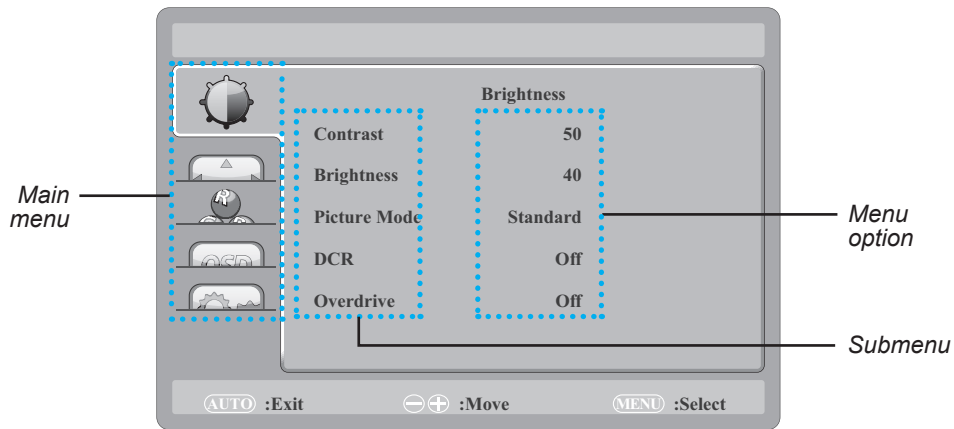

2. Press the \wedge or \vee key to select a menu and press the  key to enter the selected menu.

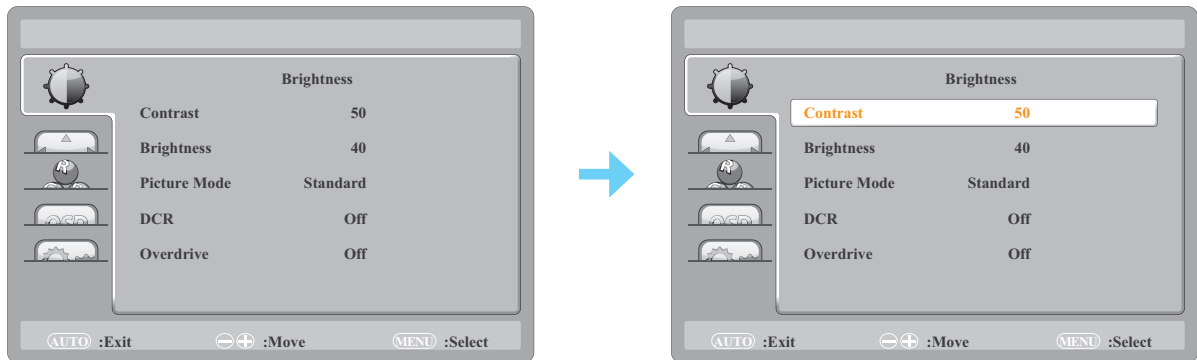

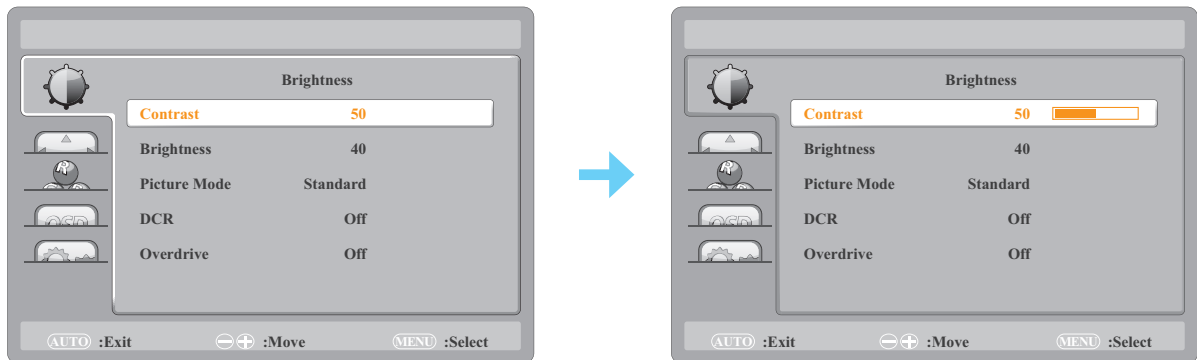

The selected menu icon appears on the left panel and the text of the selected menu option turns orange.

3. Press the \wedge or \vee key to select a submenu item and press the  key to enter its options.



The text of the selected menu option or submenu turns orange.





4. Press the \wedge or \vee key to adjust the value or select the setting.
5. To exit the submenu, press the  key.
6. To close the OSD window, press the  key repeatedly.

Note: When settings are modified, all changes are saved when the user does the following:

- Proceeds to another menu
- Exits the OSD menu
- Waits for the OSD menu to disappear

ON SCREEN DISPLAY MENU





4.2 OSD Menu Tree

Main Menu	Submenu	Reference
Brightness ()	Contrast	Refer to page 22.
	Brightness	
	Picture Mode	
	DCR	
	Overdrive	
Image Setting ()	Clock	Refer to page 24.
	Phase	
	H. Position	
	V. Position	
	Aspect Ratio	
Colour Temp. ()	Colour Temp.	Refer to page 25.
	Red	
	Green	
	Blue	
OSD Setting ()	H. Position	Refer to page 26.
	V. Position	
	OSD Timer	
	Language	
System ()	Input Select	Refer to page 27.
	DDC/CI	
	Reset	
	Information	

Note: Availability of some menu items depend on the input source signal and current setting. If the menu is not available, it is disabled and grayed out.



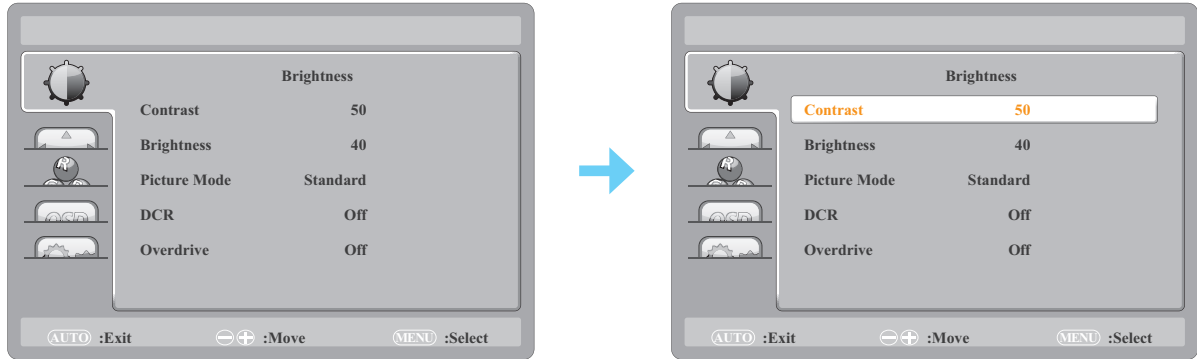

CHAPTER 5: ADJUSTING THE LCD MONITOR

5.1 Brightness Setting

1. Press the  key to call out the OSD window.
2. Press the  or  key to select  and press the  key to enter the Brightness menu.

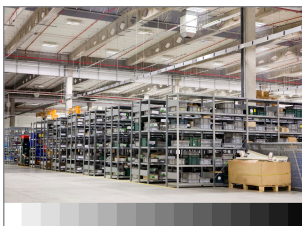
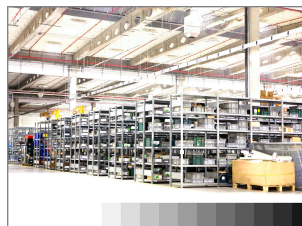
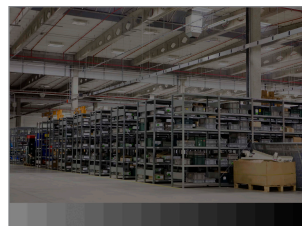

3. Press the  or  key to select a submenu item and press the  key to enter its settings.

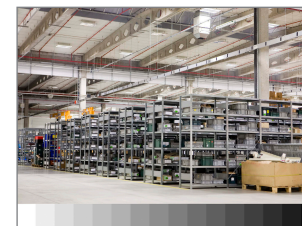
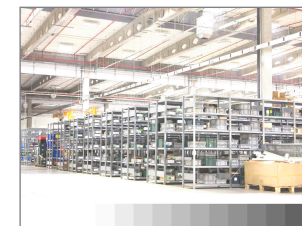
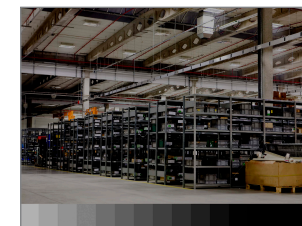
Item	Function	Operation	Range
Contrast	Adjusts the difference between the black level and the white level. Note: If the Picture Mode is set to DICOM and/or DCR is enabled, then the Contrast cannot be adjusted.	Press  /  to adjust the value.	0 to 100
	<p style="text-align: center;"><i>Original Setting</i> <i>High Setting</i> <i>Low Setting</i></p> <div style="display: flex; justify-content: space-around;">    </div>		
Brightness	Adjusts the luminance of the screen image. Note: If Picture Mode is set to DICOM and/or DCR is enabled, then the Brightness cannot be adjusted.	Press  /  to adjust the value.	0 to 100
	<p style="text-align: center;"><i>Original Setting</i> <i>High Setting</i> <i>Low Setting</i></p> <div style="display: flex; justify-content: space-around;">    </div>		

ADJUSTING THE LCD MONITOR

Item	Function	Operation	Range
Picture Mode	Selects a predefined picture setting. Note: If DCR is enabled, then the Picture Mode is preset and cannot be changed.	Press \wedge/\vee to select the setting.	Standard DICOM
DCR (Dynamic Contrast Ratio)	Activates DCR. This feature provides automatic adjustment of picture brightness and contrast at high speed and dynamic contrast range, such as when watching movies. DCR is suitable for indoor viewing.	Press \wedge/\vee to select the setting.	On Off
Overdrive	Enhances the display response time.		



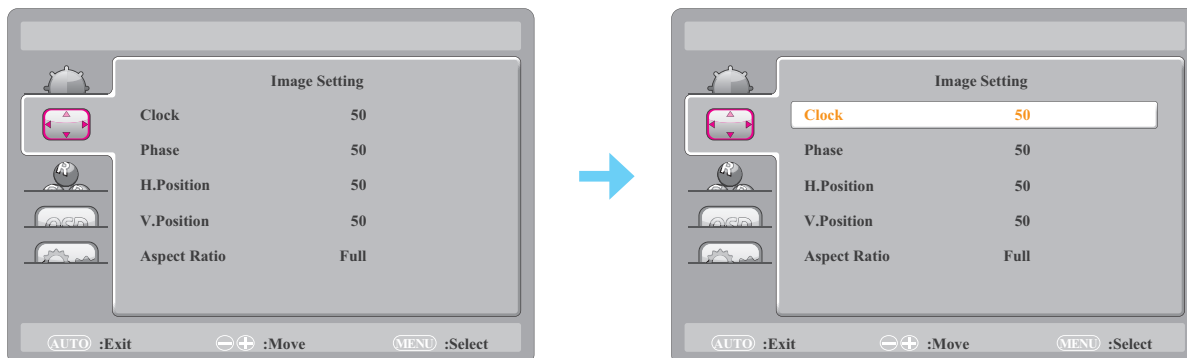

ADJUSTING THE LCD MONITOR

5.2 Image Setup Setting

1. Press the  key to call out the OSD window.
2. Press the  or  key to select  and press the  key to enter the Image Setting menu.





3. Press the  or  key to select a submenu item and press the  key to enter its settings.

Item	Function	Operation	Range
Clock	Adjusts the frequency timing to synchronise with the video signal. Note: This menu option is available for the VGA source.	Press  /  to adjust the value.	0 to 100
Phase	Adjusts the phase timing to synchronise with the video signal. Note: This menu option is available for the VGA source.		
H. Position (Horizontal Position)	Moves the screen image to the left or right. Note: This menu option is available for the VGA source.		
V. Position (Vertical Position)	Moves the screen image up or down. Note: This menu option is available for the VGA source.		
Aspect Ratio	Selects the aspect ratio of the screen image.	Press  /  to select the setting.	Full 4:3



ADJUSTING THE LCD MONITOR

5.3 Colour Temperature Setting

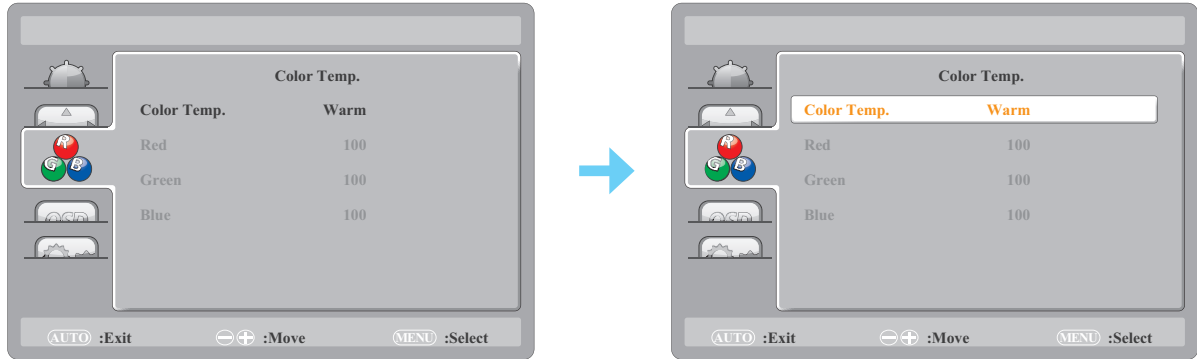
1. Press the  key to call out the OSD window.
2. Press the \wedge or \vee key to select  and press the  key to enter the Colour Temp. menu.

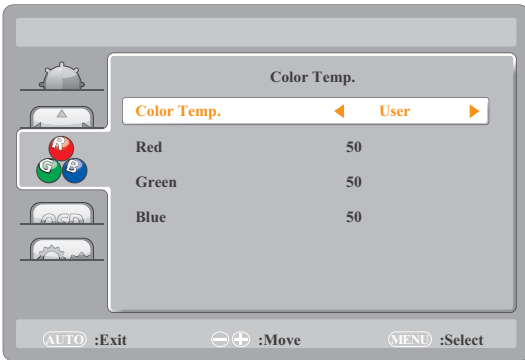

3. Press the \wedge or \vee key to select a submenu item and press the  key to enter its settings.

Item	Function	Operation	Range
Colour Temp. (Colour Temperature)	Provides several colour adjustment settings.	Press \wedge/\vee to select the setting.	Warm Neutral Cool sRGB User
	<p>If the Colour Temp. setting is set to User, you can customize the colour temperature by adjusting the red, green, and blue setting according to your preference.</p>  <ol style="list-style-type: none"> Select User and press the  key. Press the \wedge/\vee key to select the colour you want to adjust. Then press the  key to enter its submenu. Press the \wedge/\vee key to adjust the value (0 ~ 100). 		

ADJUSTING THE LCD MONITOR

5.4 OSD Setting

1. Press the  key to call out the OSD window.
2. Press the \wedge or \vee key to select  and press the  key to enter the OSD Setup menu.

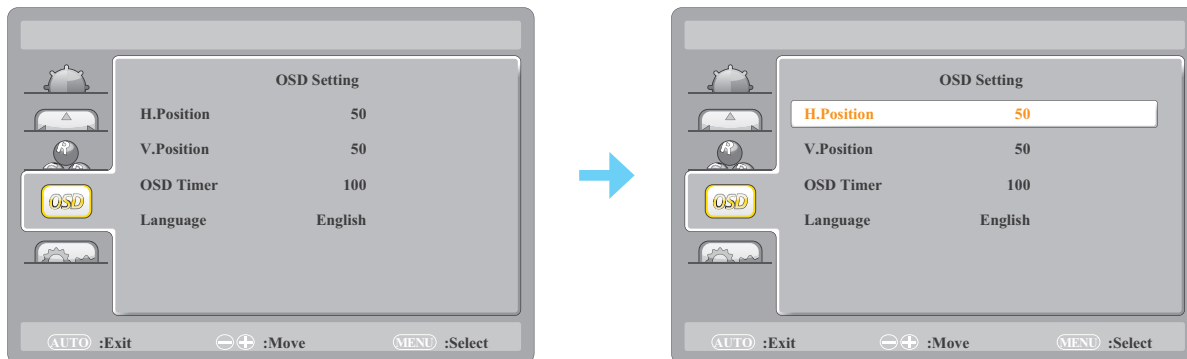





3. Press the \wedge or \vee key to select a submenu item and press the  key to enter its settings.

Item	Function	Operation	Range
H. Position (Horizontal Position)	Moves the OSD window to the left or right of the screen.	Press \wedge / \vee to adjust the value.	0 to 100 (increment by 5)
V. Position (Vertical Position)	Moves the OSD window up or down the screen.		
OSD Timer	Sets the length of time (in seconds) the OSD screen is displayed. When the time elapses, the OSD screen is automatically inactivated.		5 to 100 (increment by 5)
Language	Selects the OSD menu language.	Press \wedge / \vee to select the setting.	English 繁中 简中 Français Español Deutsch



ADJUSTING THE LCD MONITOR

5.5 System Setting

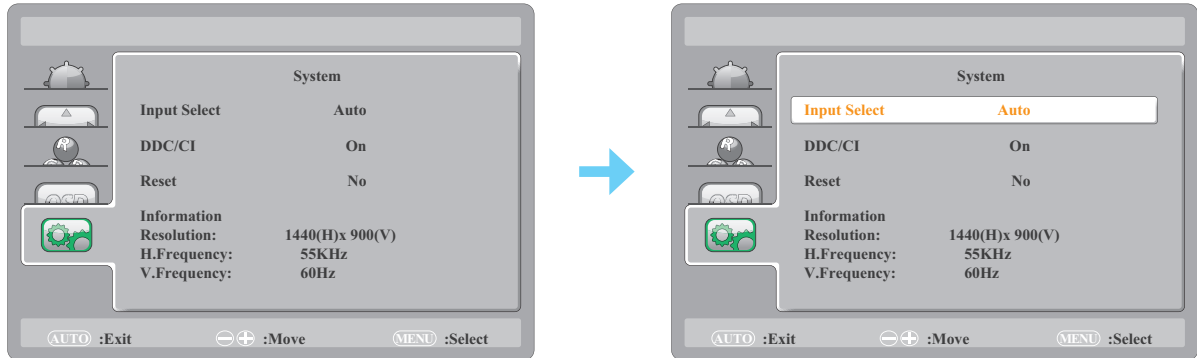
1. Press the  key to call out the OSD window.
2. Press the  or  key to select  and press the  key to enter the System menu.



3. Press the  or  key to select a submenu item and press the  key to enter its settings.

Item	Function	Operation	Range
Input Select	Switches the input source when two input signals are connected.	Press  /  to select the setting.	Auto VGA HDMI DisplayPort
DDC/CI	Activates the DDC/CI protocol to allow users to configure the monitor by a software using two wires on the VGA, HDMI, DisplayPort cables.		On Off
Reset	Resets all your customized settings to the factory defaults.		Yes No
Information	Displays the information of the input source such as resolution, horizontal frequency, and vertical frequency.	-	-

CHAPTER 6: APPENDIX

6.1 Warning Messages

When any of these warning messages appear, check the following items.

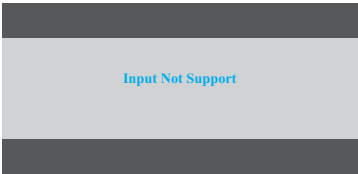
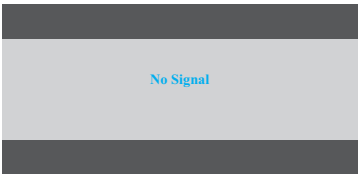
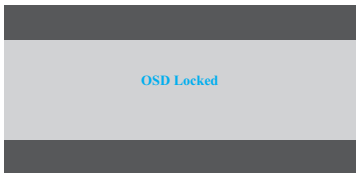
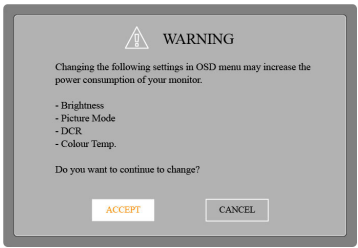
Warning Message	Cause	Solution
	The resolution or the refresh rate of the graphics card of the computer is set too high.	√ Change the resolution or the refresh rate of the graphics card.
	The LCD monitor cannot detect the input source signal.	√ Check if the input source is turned ON. √ Check if the signal cable is properly connected. √ Check if any pin inside the cable connector is twisted or broken.
	The OSD has been locked by the user.	√ Unlock the OSD. Refer to page 18.
	This warning message box will only show when the menu feature setting is changed for the first time.	√ Select ACCEPT to continue the setting changes, or select CANCEL to disable the setting changes. <div style="border: 1px solid gray; padding: 5px; background-color: #f0f0f0;"> <p>Note: <i>The operation may vary from different product models.</i></p> </div>



CHAPTER 6: APPENDIX

6.2 Timing

VESA MODES							
Mode	Resolution	Total	Horizontal		Vertical		
			Nominal Frequency ± 1kHz	Sync Polarity	Nominal Frequency ± 1kHz	Sync Polarity	Nominal Clock (MHz)
VGA	640 x 480 @ 60 Hz	800 x 525	31.469	N	59.940	N	25.175
	640 x 480 @ 72 Hz	832 x 520	37.861	N	72.809	N	31.500
	640 x 480 @ 75 Hz	840 x 500	37.500	N	75.00	N	31.500
SVGA	800 x 600 @ 56 Hz	1024 x 625	35.156	N/P	56.250	N/P	36.000
	800 x 600 @ 60 Hz	1056 x 628	37.879	P	60.317	P	40.000
	800 x 600 @ 72 Hz	1040 x 666	48.077	P	72.188	P	50.000
	800 x 600 @ 75 Hz	1056 x 625	46.875	P	75.000	P	49.500
XGA	1024 x 768 @ 60 Hz	1344 x 806	48.363	N	60.004	N	65.000
	1024 x 768 @ 70 Hz	1328 x 806	56.476	N	70.069	N	75.000
	1024 x 768 @ 75 Hz	1312 x 800	60.023	P	75.029	P	78.750
SXGA	1280 x 1024 @ 60 Hz	1688 x 1066	63.981	P	60.020	P	108.000
	1280 x 1024 @ 75 Hz	1688 x 1066	79.976	P	75.025	P	135.000
WXGA+	1440 x 900 @ 60 Hz	1904 x 934	55.935	N	59.887	P	106.500
	1440 x 900 @ 60 Hz	1600 x 926	55.469	P	59.901	N	88.750
WSXGA	1680 x 1050 @ 60 Hz	2240 x 1089	65.290	N	59.954	P	146.250
	1680 x 1050 @ 60 Hz	1840 x 1080	64.674	P	59.883	N	119.000
HD	1920 x 1080 @ 60 Hz	2200 x 1125	67.500	N	60.000	N	148.500
VESA	1152 x 864 @ 75 Hz	1600 x 900	67.500	P	75.000	P	108.000
	1280 x 960 @ 60 Hz	1800 x 1000	60.000	P	60.000	P	108.000
IBM MODES							
DOS	720 x 400 @ 70 Hz	900 x 449	31.469	N	70.087	P	28.322
MAC MODES							
VGA	640 x 480 @ 67 Hz	864 x 525	35.000	N	66.667	N	30.240
XGA	1024 x 768 @ 75 Hz	1328 x 804	60.241	N	74.927	N	80.000

APPENDIX

6.3 Troubleshooting

Problems	Possible Cause and Solution
No picture. <ul style="list-style-type: none">• LED indicator is OFF.	<ul style="list-style-type: none">• Check if the LCD monitor is turned ON.• Check if the power cord is properly connected to the LCD monitor.• Check if the power cord is plugged into the power outlet.
<ul style="list-style-type: none">• LED indicator is blue.	<ul style="list-style-type: none">• Check if the computer is turned ON.• Check if the computer is in standby mode, move the mouse or press any button to wake up the computer.
Image position is incorrect.	<ul style="list-style-type: none">• For VGA input, adjust the H. Position and V. Position settings in Image Setting () menu (refer to page 24).
The displayed texts are blurry.	<ul style="list-style-type: none">• For VGA input, press and hold the  key to auto adjust the screen.• For VGA input, adjust the Clock and Phase settings in Image Setting () menu (refer to page 24).
Red, blue, green, white dots appear on the screen.	<ul style="list-style-type: none">• There are millions of micro transistors inside the LCD monitor. It is normal for a few transistors to be damaged and to produce spots. This is acceptable and is not considered a failure.
No audio output.	<ul style="list-style-type: none">• Audio output is not supported.
Dew formed on the LCD monitor.	<ul style="list-style-type: none">• This normally happens when the LCD monitor is moved from a cold room to a hot room temperature. Do not turn ON the LCD monitor, wait for the dew condensation to disappear.
Faint shadows from a static image appear on the screen.	<ul style="list-style-type: none">• Turn off the LCD monitor for extended periods of time.• Use a screen saver or a black and white image and run it for extended periods of time.

APPENDIX

6.4 Transporting the LCD Monitor

To transport the LCD monitor for repair or shipment, place the monitor in its original packaging box.

1. Remove the stand.

Remove the screws securing the stand to the LCD monitor. Then remove the stand.

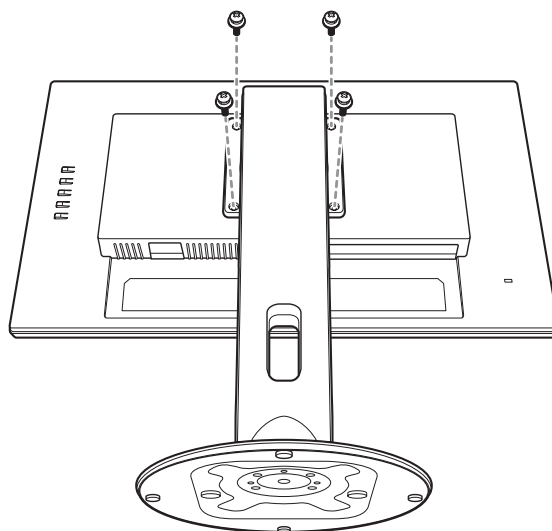

2. Place the LCD monitor down in the lower foam cushion.

3. Place the upper foam cushion on the top of the LCD monitor.

4. Place the stand and accessories on the designated area (if necessary).

5. Place the LCD monitor assembly in the box and tape the box.

APPENDIX

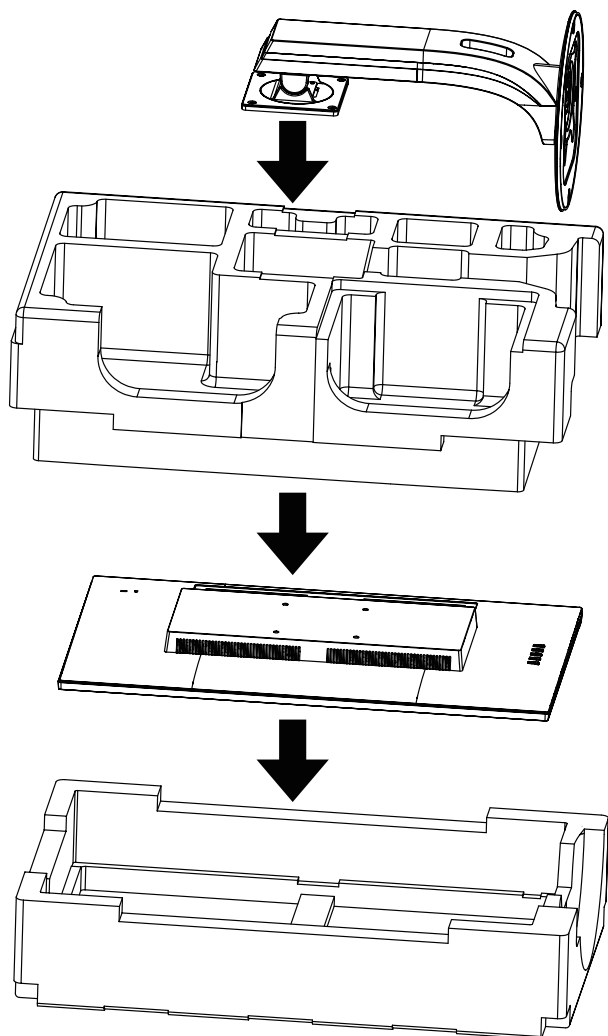

Note:

- *It is recommended to use the original packaging box.*
- *When repacking, carefully place the LCD monitor in its box and protect the glass panel from touching any object.*

CHAPTER 7: SPECIFICATIONS

7.1 Monitor Specifications

		MD-2402	MD-2702
Panel	Panel Type	LED-Backlit TFT LCD (VA Technology)	LED-Backlit TFT LCD (VA Technology)
	Panel Size	23.8"	27.0"
	Max. Resolution	FHD 1920 x 1080	FHD 1920 x 1080
	Pixel Pitch	0.275 mm	0.311 mm
	Brightness	250 cd/m ²	300 cd/m ²
	Contrast Ratio	20,000,000:1 (DCR)	20,000,000:1 (DCR)
	Viewing Angle (H/V)	178°/178°	178°/178°
	Display Colour	16.7M	16.7M
	Response Time	5 ms	5 ms
Frequency (H/V)	Frequency (H)	30 kHz-83 KHz	30 kHz-83 KHz
	Frequency (V)	50 Hz-76 Hz	50 Hz-76 Hz
Input	VGA	15-Pin D-Sub x 1	15-Pin D-Sub x 1
	HDMI	1.4 x 1	1.4 x 1
	DisplayPort	x 1	x 1
Power	Power Supply	External	External
	Power Requirements	DC 12V, 1.96A	DC 12V, 2.5A
	On Mode	13W (On)	16W (On)
	Stand-by Mode	< 0.3W	< 0.3W
	Off Mode	< 0.2W	< 0.2W
Operating Conditions	Temperature	0°C-40°C (32°F-104°F)	0°C-40°C (32°F-104°F)
	Humidity	10%-85% (non-condensing)	10%-85% (non-condensing)
Storage Conditions	Temperature	-25°C-55°C (-13°F-131°F)	-25°C-55°C (-13°F-131°F)
	Humidity	5%-93%(non-condensing)	5%-93%(non-condensing)
DICOM		Yes	Yes
Mounting	VESA FPM PMI	Yes (100 x 100 mm)	Yes (100 x 100 mm)
Stand	Tilt	-5° to 23°	-5° to 23°
Security	Kensington Security Slot	Yes	Yes
Dimensions	Product with Base (W x H x D)	539.5 x 498.0 x 249.0 mm (21.2" x 19.6" x 9.8")	612.6 x 519.8 x 249.0 mm (24.1" x 20.5" x 9.8")
	Packaging (W x H x D)	625.0 x 403.0 x 280.0 mm (24.6" x 15.9" x 11.0")	700.0 x 456.0 x 282.0 mm (27.6" x 18.0" x 11.1")
Weight	Product with Base	5.2 kg (11.5 lb)	6.1 kg (14.5 lb)
	Packaging	7.4 kg (11.5 lb)	8.8 kg (19.4 lb)

Note: All specifications are subject to change without prior notice.

SPECIFICATIONS

7.2 Monitor Dimensions

7.2.1 MD-2402 Dimensions

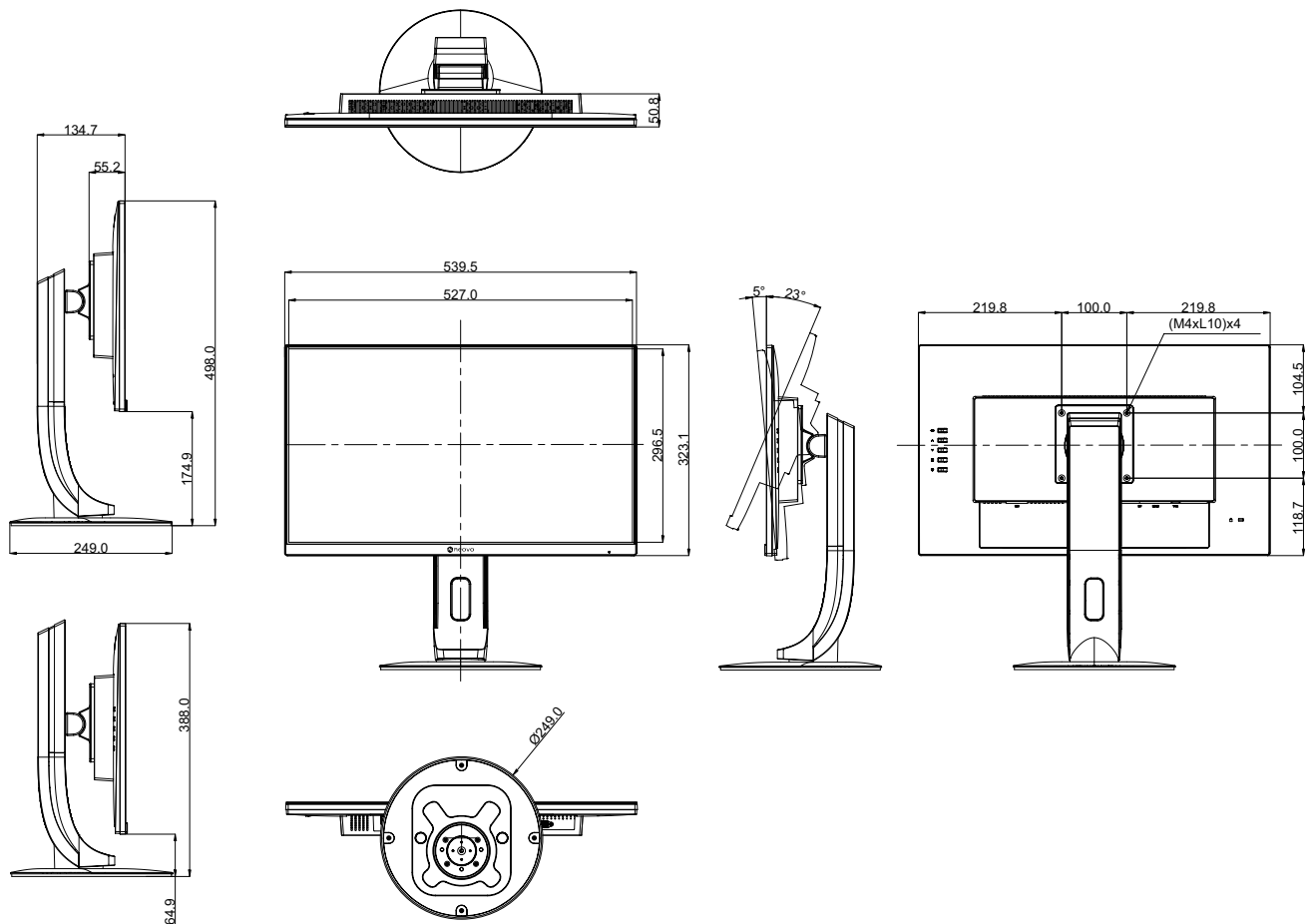

SPECIFICATIONS

7.2.2 MD-2702 Dimensions

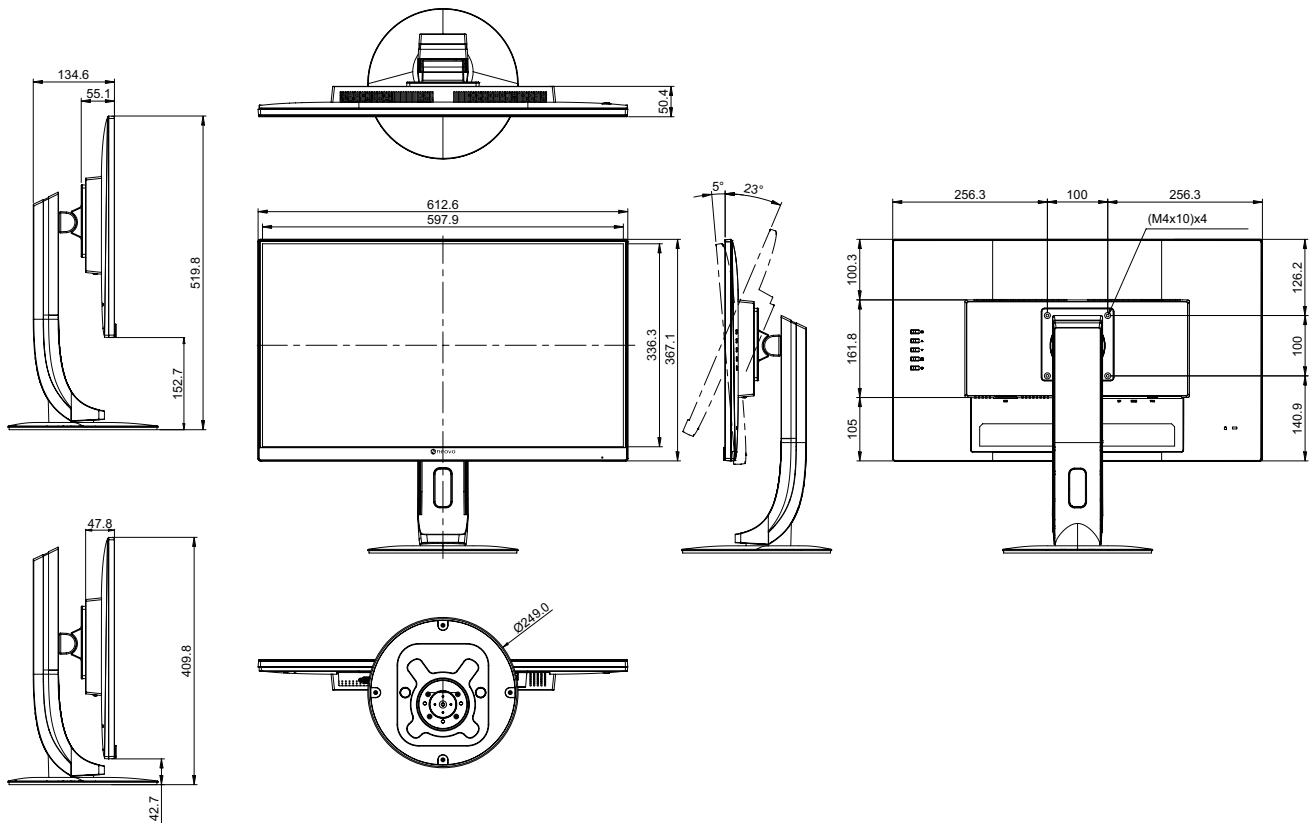

AG Neovo

Company Address: 5F-1, No. 3-1, Park Street, Nangang District, Taipei, 11503, Taiwan.

Copyright © 2021 AG Neovo. All rights reserved.

MD-2402/MD-2702 Eprel registration number: 775395/775402

MD2420/MD2720_UM_V011