



BG-MAESTRO-H

1080P Full HD 8MP HDMI Auto-Tracking Wide Angle ePTZ Camera

User Manual







Table of Contents

Statement	4
Safety Precaution	4
Introduction	5
Features	5
Packing List	6
Specifications	7
Wall Mount Installation	8
Interfaces	9
Dimensions	9
Web Interface Login and Tracking Settings	10
Web Client Login	12
Web Interface Preview Tab	12
Web Interface Configuration Tab	13
Audio Configure	14
Video Configure	15
Network Configure	23
Camera Configure	25
Logout	26
Tracking Configuration	27
Tech Support	28
Warranty	28
Mission Statement	28
Copyright	28



Statement

Please read these instructions carefully before connecting, operating, or configuring this product. Please save this manual for future reference.

Safety Precaution

- To prevent damaging this product, avoid heavy pressure, strong vibration, or immersion during transportation, storage, and installation.
- The housing of this product is made of organic materials. Do not expose to any liquid, gas, or solids which may corrode the shell.
- Do not expose the product to rain or moisture.
- To prevent the risk of electric shock, do not open the case. Installation and maintenance should only be carried out by qualified technicians.
- Do not use the product beyond the specified temperature, humidity, or power supply specifications.
- This product does not contain parts that can be maintained or repaired by users. Damage caused by dismantling the product without authorization from BZBGear is not covered under the warranty policy.
- Installation and use of this product must strictly comply with local electrical safety standards.



Introduction

The BG-MAESTRO is a compact ePTZ auto-tracking camera that delivers exceptionally accurate tracking throughout its coverage area. Designed to be easily configured without requiring additional software, the auto-tracking parameters are set through the web based interface. Tracking is performed with the electronic pan, tilt, and zoom (ePTZ) capabilities via a fixed lens to maintain a compact form factor. Power over ethernet (PoE) technology further simplifies installation by requiring only one cable for power and internet connectivity.

The BG-MAESTRO features a 1/2.8" high quality 4K CMOS sensor and can simultaneously output USB 3.0, HDMI, and IP streaming in resolutions up to 1080p@30Hz. With 3x digital zoom and ePTZ controls, the camera automatically tracks subjects between distances of 15ft to 50ft within its field of view.

Features

- **Intelligent Tracking:** Built-in leading image recognition and tracking algorithms track targets stably, accurately, and quickly without any tracking host.
- **Subject Tracking/Anti-Interference:** The automated tracking stays locked on the initial target without the auto tracking function redirecting itself to an interfering subject passing through the frame.
- **Smooth Tracking:** The adjustable tracking modes, speed, and sensitivity ensure the best possible shot based on the target's movements and desired frame.
- **Tailor to the Environment:** The tracking performance is not affected by the room's size or shape and can mask out objects that may interfere with tracking.
- **Dynamic Exposure:** Prevents issues with the darkening of tracked targets against strong light backgrounds.
- **Multiple Tracking Modes:** Real-time tracking, movie tracking, and area tracking.
- **Ultra HD:** 1/2.8 inch high quality 4K CMOS sensor.
- **Distortion-free Lens:** 4K distortion-free lens with 3X digital zoom and EPTZ controls.
- **Low Noise and High SNR:** The low-noise and high SNR CMOS sensor keeps the picture clean and clear even in low light conditions.



- **Multiple Video Compression Formats:** USB supports H264, MJPG, YUY2, NV12 video compression formats and the network supports H.264, H.265 video compression formats.
- **Multiple Video Outputs:** Simultaneously outputs HDMI, USB 3.0 and LAN (Gigabit) video streams.
- **Multiple Streams:** Supports up to five streams simultaneously. Output a close-up main-stream, close-up sub-stream, panoramic stream, panoramic sub-stream and director stream.
- **PoE Support:** Power, control, and output video using one CAT cable.
- **Flexible Installation:** Wall mount and ceiling mount options available.
- **Web Interface:** Take control via a network connection to help meet different deployment needs.

Packing List

- 1 x Power Adapter
- 1 x USB 3.0 Cable
- 1 x Mounting Arm
- 1 x User Manual
- 1 x BG-MAESTRO-H



Specifications

Camera/ Lens Parameters	
Image Sensor	1/2.8 inch High Quality 4K CMOS Sensor
Effective Pixels	8.28 megapixel, 16: 9
Video Format	HDMI/U3:MJPEG/H264 : 1920*1080/1600*896 /1280*720 /1024*576 /960*540 /800*600 /800*448 /720*576/720*480 /640*480 /640*360 /480*270 /352*288 /320*240@30/25/20/15/10/5fps; 1080p30, 1080p25, 1080i60, 1080i50, 720p60, 720p50 YUY2/NV12: 1920*1080 /1280*720 /1024*576 /800*600 /800*448 /640*480 /640*360 /480*270 /320*180@30/25/20/15/10/5fp USB3.0 compatible with USB2.0 output
Viewing Angle	51.6°(D)/45.5°(H)/26.5°(V)
Focal Length	f=6.8mm
Iris	F2.5
Digital Zoom	3X
Minimum Illumination	0.1Lux(F1.8, AGC ON)
DNR	2D & 3D
White Balance	Auto / Manual/ One Push/ Specified color temperature (2400K-7100K, step length is 100)
Focus	Fixed
Exposure	Auto/Manual/Shutter priority (SAE)/Brightness priority
BLC	On/Off
SNR	>50dB
Interface	
Video Output	1X HDMI; 1X USB; 1X LAN:10M/100M/1000M adaptive Ethernet port (supports PoE)
Video Compression Format	H.264, H.265, MJPEG, YUY2, NV12
Audio Input	Dual channel 3.5mm linear input
Audio Compression Format	AAC, MP3, G.711A
Network Protocols	RTSP, RTMP, SRT, ONVIF, GB/T28181
Control Jacks	RS232, RS485, LAN
Communication Protocols	VISCA; Baudrate: 115200/38400/9600/4800/2400; Support network VISCA protocol
Power Jack	DC12V



Others		
Working Voltage	Power Adapter	12V
	PoE	48V
Working Current	Power Adapter	0.42A(max)
	PoE	0.104A(max)
Power Consumption	5W(max)	
Storage Temperature	-10°C ~ +60°C	
Storage Humidity	20% ~ 95%	
Working Temperature	-10°C ~ +50°C	
Working Humidity	20% ~ 80%	
Dimension (W X H X D)	5.9 x 3.1 x 3.1in [149.2 x 78 x 78mm]	
Weight	Approximate 1.17 lbs [0.53kg]	
Environment	Indoors	
Accessory	Power Adapter, USB 3.0 Cable, User Manual, Packing List	

Wall Mount Installation

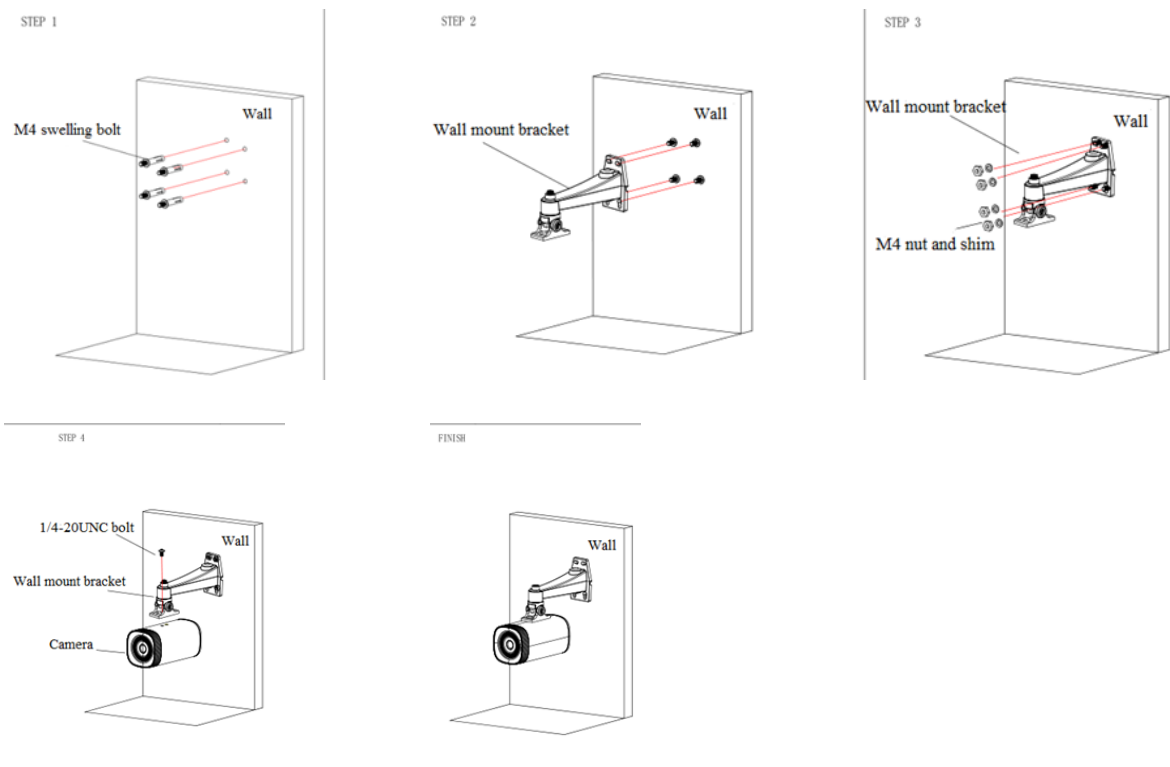



Interfaces

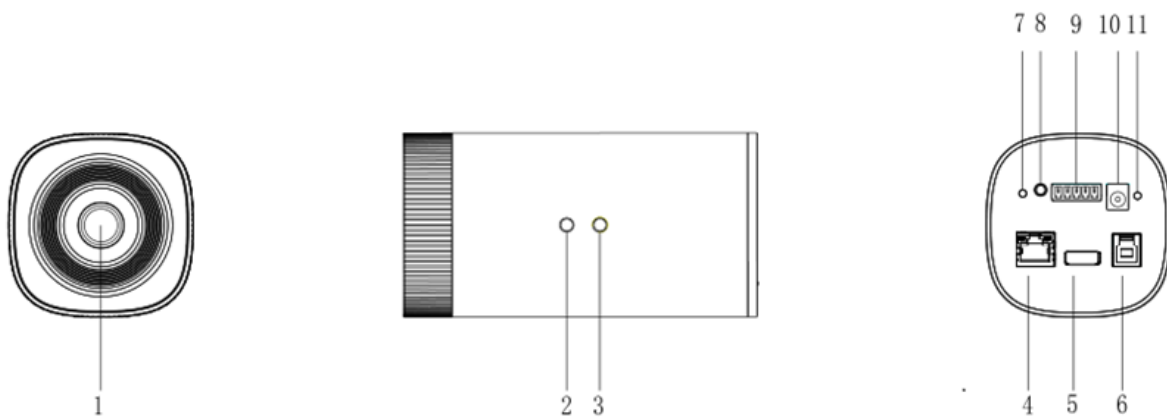

1	Lens	5	HDMI output	9	RS232 / RS485
2	Mounting Arm hole	6	USB 3.0	10	Power jack
3	Tripod Hole	7	Reset button	11	Power indicator
4	LAN interface	8	3.5mm Stereo line-in		

Dimensions

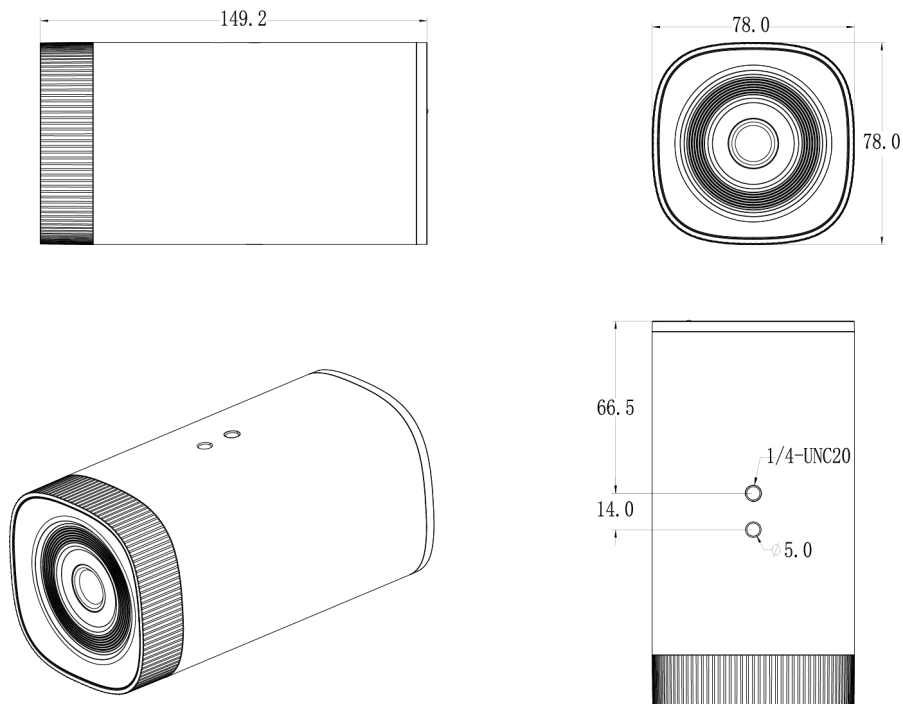



Web Interface Login and Tracking Settings

Network Connection

Connection Modes

Direct connection: Connect the camera directly to the computer using an ethernet cable.

Internet connection mode: Connect the camera and computer to a router or switch and access via the local area network (LAN).

Note: Ensure power and network connections are secured to prevent video issues caused by poor connection quality.

The computer must be on the same subnet as the camera to connect successfully. The device will not be accessible otherwise. The **camera default IP address is 192.168.5.163**, therefore the computer must be connected to the 192.168.5.x subnet.

To connect to the camera, open the Local Area Connection Properties on the computer.

For Windows users right-click on the internet connection in the lower right corner of the desktop.

Select **“Open Network & Internet Settings”**.

Select **“Change Adapter Options”**.

Right-click on your connection (Wi-Fi or Ethernet) and select **“Properties”**.

Select **“Internet Protocol Version 4 (TCP/IPv4)”** as shown below and click **“Properties”**.

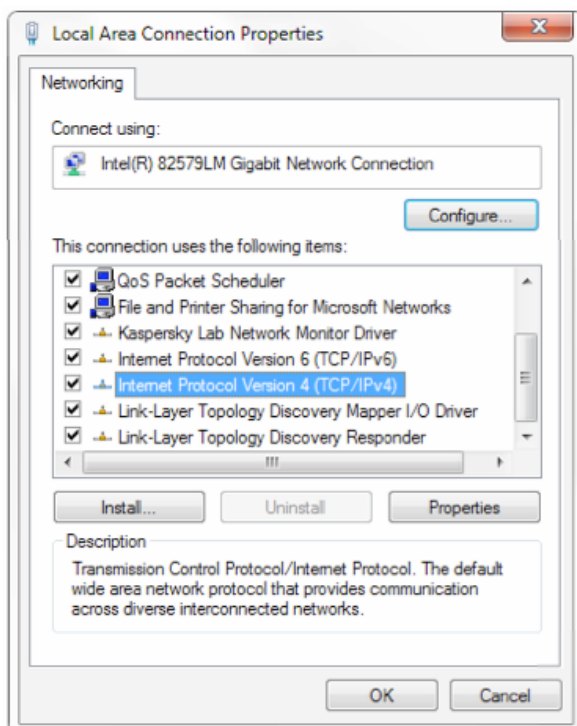



For the following steps refer to the diagram below.

Click on the bubble for **“Use the following IP address”**

In the **IP address** field enter a non-conflicting IP address on the same subnet as the camera. If there is another device with the same IP address you will not be able to connect. In the example below we are using 192.168.5.200

In the **Subnet mask** field enter 255.255.255.0

In the **Default gateway** field type 192.168.5.1

You can leave the DNS fields blank.

Click **OK** to apply your settings.

NOTE: When you are finished configuring the camera you will need to return to this screen and click the bubbles for **“Obtain an IP address automatically”** and **“Obtain DNS server automatically”** to restore internet connectivity to your computer. Also make sure to reconnect any ethernet cables you may have unplugged.

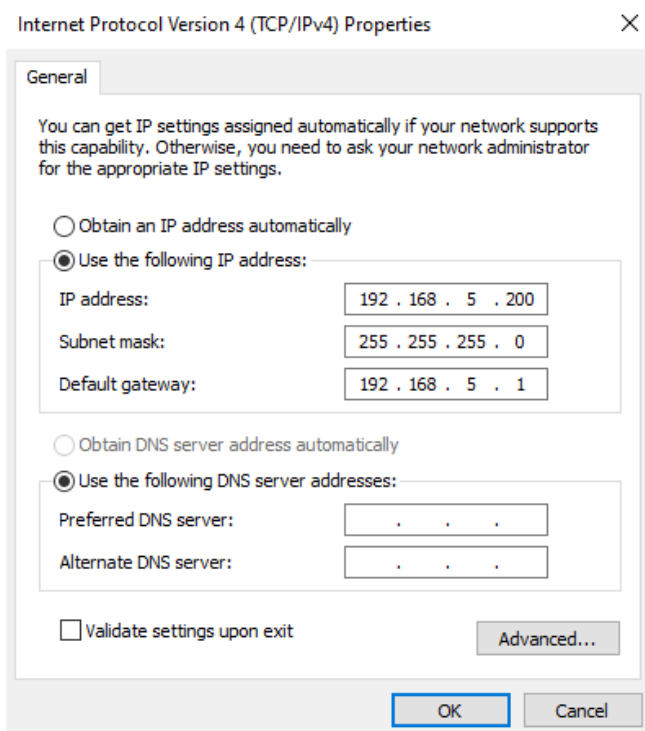

CAUTION: The IP address to be added cannot be the same as other computers or devices on the network.



Web Client Login

Input the IP address of the device (192.168.5.163) in the address field of your web browser and press the enter key to enter the Web Client login page.



Users can login as an administrator and normal user. To login as an administrator the **default Username/Password: admin.** Admin users can preview, playback, and configure settings in the Web Client.

To login as a normal user **default Username/Password: user1 or user2).** Users can only preview, playback, and logout, they cannot configure the camera settings.

Web Interface Preview Tab

In the Preview interface, users can utilize the PTZ, zoom, and focus controls as well as preview embedded audio, the various available streams, 3D localization, and manage preset positions. Administrators can also set up tracking configurations and turn tracking on/off.

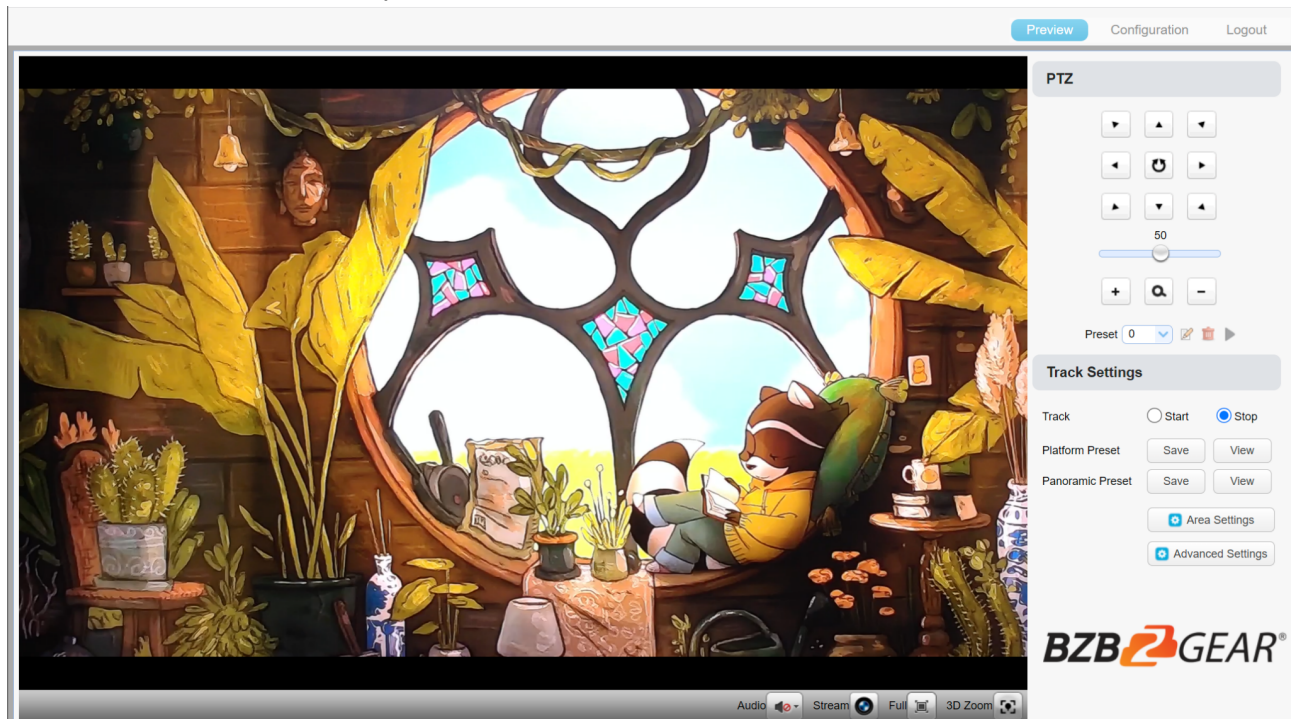

Note: Normal users cannot configure settings.



Web Interface Configuration Tab

Click “Configuration” in the top left to enter into the device setting page.

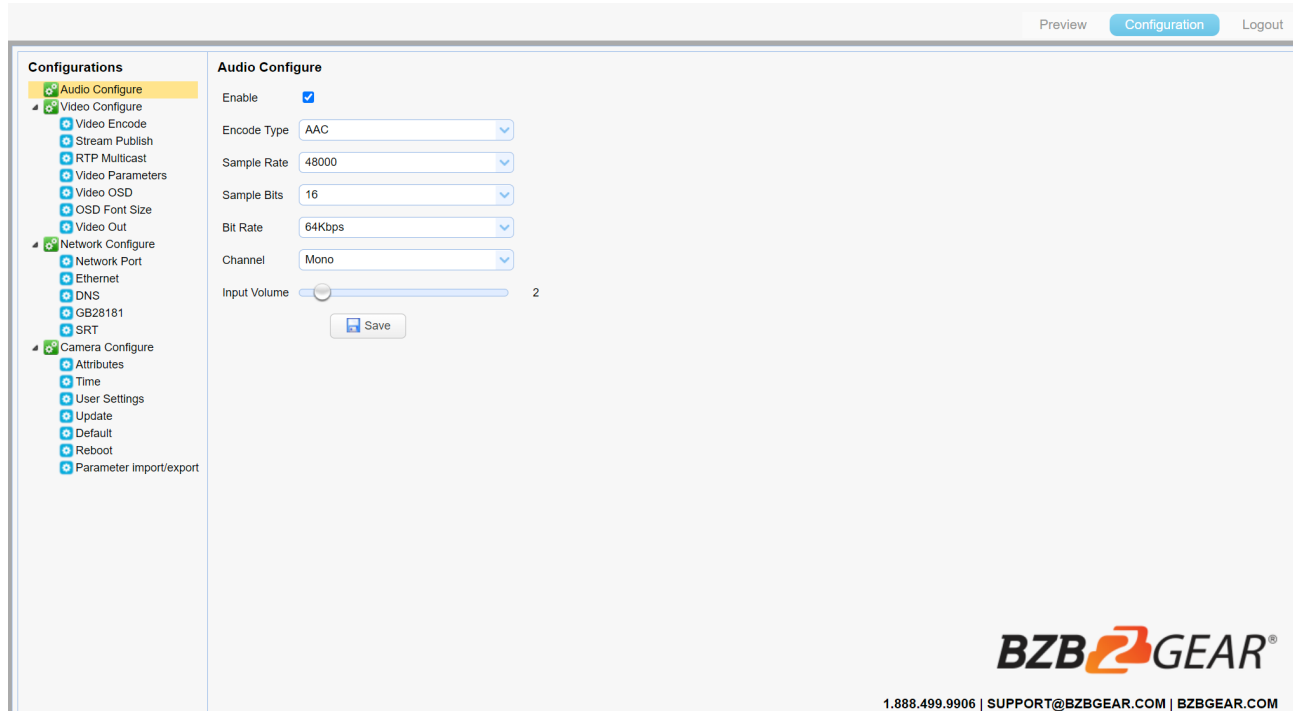

Menu	Description
Audio Configure	Enable/Disable audio switch, compression format, sample rate, sampling precision, bit rate, channel (mono/stereo), and input volume.
Video Configure	Video encode, stream publish, RTP multicast ,video parameters, video OSD, OSD font size, output resolution.
Network Configure	Port, Ethernet, DNS, GB28181, SRT settings.
Camera Configure	System attributes, time, user management, update, factory reset, reboot, and import/export configuration.



Audio Configure

Configurations

- ⚙️ Audio Configure
- ▾ ⚙️ Video Configure
 - ⚙️ Video Encode
 - ⚙️ Stream Publish
 - ⚙️ RTP Multicast
 - ⚙️ Video Parameters
 - ⚙️ Video OSD
 - ⚙️ OSD Font Size
 - ⚙️ Video Out
- ▾ ⚙️ Network Configure
 - ⚙️ Network Port
 - ⚙️ Ethernet
 - ⚙️ DNS
 - ⚙️ GB28181
 - ⚙️ SRT
- ▾ ⚙️ Camera Configure
 - ⚙️ Attributes
 - ⚙️ Time
 - ⚙️ User Settings
 - ⚙️ Update
 - ⚙️ Default
 - ⚙️ Reboot
 - ⚙️ Parameter import/export

Audio Configure

Enable

Encode Type

Sample Rate

Sample Bits

Bit Rate

Channel

Input Volume 2

Enable: Choose to enable/disable embedded audio (default: off).

Encode Type: Set audio compression format and the device will reboot automatically after a change (AAC, MP3, G.711A)

Sampling Rate: Set the sampling frequency and the device will reboot automatically after a change (16000, 32000, 44100, 48000)

Sampling Bits: Set sampling precision (16 bits)

Channel: Set audio compressing code rate (default 64bits, 32, 48, 96, 128bits optional)

Channel Type: Set audio channel type (default mono, stereo optional)

Input Volume: Set the input volume (default 2, 1-10 optional)



Video Configure

1. Video Encoding

Configurations	Video Encode
Audio Configure	Stream <input type="text" value="Close-up Main Stream"/>
Video Configure	Compressed Format <input type="text" value="H.264"/>
Video Encode	Profile <input type="text" value="HP"/>
Stream Publish	Image Size <input type="text" value="1920*1080"/>
RTP Multicast	Rate Control <input type="text" value="CBR"/>
Video Parameters	Image Quality <input type="text" value="Best"/>
Video OSD	Bit Rate(Kb/s) <input type="text" value="4096"/>
OSD Font Size	Frame Rate(F/S) <input type="text" value="30"/>
Video Out	I Frame Interval <input type="text" value="30"/>
Network Configure	I Frame Min QP <input type="text" value="20"/>
Network Port	Stream Key <input type="text" value="live/av0"/>
Ethernet	
DNS	
GB28181	
SRT	
Camera Configure	
Attributes	
Time	
User Settings	
Update	
Default	
Reboot	
Parameter import/export	

Save

Stream: Set different video output mode settings when running different streams. (close-up main stream, close-up sub-stream, panoramic main stream, panoramic sub-stream, and Inter PGM stream)

Compression Format: Set the video compression format, save and reboot to take effect (main / secondary stream default: H.264, H.265 optional)

Profile: Set Profile mode (default HP, BP, MP optional)

Video Size: Set video image resolution, save and reboot to take it effect (close-up main stream default 1920*1080, 1280*720, 640*480 optional; close-up sub-stream default 320*180, 320*240, 640*360, 640*480, 1280*720 optional; panoramic main stream default 1920*1080, 1280*720, 640*480 optional; panoramic sub-stream default 320*180, 320*240, 640*360, 640*480, 1280*720 optional; Inter PGM stream default 1920*1080, 1280*720, 640*480 optional)

Rate Control: Set rate control mode (default CBR [controlled bit rate], VBR [variable bit rate] optional) save and reboot to take effect.

Image Quality: Set the image quality which can be changed only when the rate control is set to VBR (main stream is defaulted to best, secondary stream is default to better (options are best, better, good, bad, worse, worst).

Bit Rate(Kb/s): Set the video bit rate (close-up main stream default 4096Kb/s; close-up sub-stream default 512Kb/s; panoramic main stream default 4096Kb/s; panoramic sub-stream default 512Kb/s; and broadcast code stream default 4096Kb/s, (64-40960Kb/s optional).



Frame Rate (F/S): Set the video frame rate (close-up main stream, close-up sub-stream, panoramic main stream, panoramic sub-stream, and broadcast code stream default 30F/S, main stream 5-30F/S optional).

I Frame Interval: Set the key frame interval (close-up main stream, close-up sub-stream, panoramic main stream, panoramic sub-stream, and broadcast code stream default 30, main stream 1-150F optional).

I Frame Minimum QP: Set the key frame minimum QP (default 20, 10-51 optional).

Stream Name: When streaming via RTSP or RTMP, users can modify the stream name (close-up main stream(default live/av0), close-up sub-stream(default live/av1), panoramic main stream(default live/av2), panoramic sub-stream(default live/av3), and broadcast code stream(default live/av4)).

(Covered by one or more claims of the HEVC patents listed at patentlist.accessadvance.com)

2. Stream Publish

Configurations	Stream Publish
Audio Configure	Stream <input type="text" value="Close-up Main Stream"/>
Video Configure	Enable <input type="checkbox"/>
Video Encode	Protocol Type <input type="text" value="RTMP"/>
Stream Publish	Host Address <input type="text" value="192.168.5.11"/>
RTP Multicast	Host Port <input type="text" value="1935"/>
Video Parameters	Stream Key <input type="text" value="live/av0"/>
Video OSD	Username <input type="text"/>
OSD Font Size	Password <input type="text"/>
Video Out	Password for stream encryption <input type="text"/>
Network Configure	Crypto key length in bytes <input type="text" value="0"/>
Network Port	<input type="button" value="Save"/>
Ethernet	
DNS	
GB28181	
SRT	
Camera Configure	
Attributes	
Time	
User Settings	
Update	
Default	
Reboot	
Parameter import/export	

Stream: You can set close-up main stream, close-up sub-stream, panoramic main stream, panoramic sub-stream, and broadcasting stream

Enable: Turn on/off stream publish

Protocol Type: Set protocol (default RTMP protocol, RTSP, SRT are optional)

Host Address: Server IP address (default 192.168.5.11)

Host Port: Server port number (default 1935, 0-65535 optional)

Stream Name: Choose a different stream name (live/av0, live/av1, live/av2, live/av3, live/av4 optional).

User: Set the user name.

Password: Set the password.

Password for stream encryption: Set SRT stream password.

Crypto key length in bytes: Set the length of the SRT stream password.



3. RTP Multicast

Configurations	RTP Multicast
Audio Configure	Stream <input type="text" value="Close-up Main Stream"/>
Video Configure	Enable <input type="checkbox"/>
Video Encode	Protocol Type <input type="text" value="RTP"/>
Stream Publish	Multicast Address <input type="text" value="224.1.2.3"/>
RTP Multicast	Multicast Port <input type="text" value="4000"/>
Video Parameters	Access Method <input type="text" value="rtp://224.1.2.3:4000"/>
Video OSD	<input type="button" value="Save"/>
OSD Font Size	
Video Out	
Network Configure	
Network Port	
Ethernet	
DNS	
GB28181	
SRT	

Stream: Set multicast or unicast on close-up main stream, close-up sub-stream, panoramic main stream, panoramic sub-stream, and inter PGM stream.

Enable: Turn on/off multicast (enabled) or unicast (disabled).

Protocol Type: Set multicast protocol (default RTP multicast, TS multicast optional)

Multicast Address: Default 224.1.2.3. The IP address can be edited.

Multicast Port: Main Stream Default Port: close-up main stream default 4000, close-up sub-stream default 4002, panoramic main stream default 4004, panoramic sub-stream default 4006, inter PGM stream default 4008.

Access Method: Address changes depending on stream, multicast address, and multicast port entered (i.e. rtp: //224.1.2.3:4000; udp: //@224.1.2.3:4000)



4. Video Parameters

a. Exposure: Exposure mode, EV, back light compensation, flicker, gain limit, DRC, shutter speed, and brightness can be set depending on mode selected.

The screenshot shows the 'Video Parameters' configuration window. On the left is a sidebar with a tree view of configurations, including 'Audio Configure', 'Video Configure', 'Network Configure', and 'Camera Configure'. 'Video Parameters' is highlighted in yellow. The main area features a video preview of a character in a whimsical setting. Below the preview are tabs for 'Exposure', 'Color', 'Image', 'NR', and 'Style', with 'Exposure' selected. A 'Refresh' button is located to the right of the tabs. The 'Exposure' settings are as follows:

- Mode: Auto (dropdown menu)
- EV: OFF (toggle)
- BLC: OFF (toggle)
- Flicker: 50Hz (dropdown menu)
- G.Limit: 3 (slider)
- DRC: 2 (dropdown menu)

Below the settings, there are two red text notes:

- *Click the "Refresh" button to refresh parameter.
- *Effective after changed parameters

Exposure Mode: Set the exposure mode (the default is auto, manual, SAE, and bright available).

EV: Set the exposure compensation value. Turn EV to 'On' when auto mode is active (default 0, -7 to 7 optional).

BLC: Set back light compensation, usable auto mode is active (default is off).

Flicker: Set anti-flicker mode, usable when auto or bright modes are active (50Hz, closed, 60Hz).

Gain Limit: Set the gain limit, only valid when mode is set to auto or bright (default 4, 0-15).

DRC: Set the dynamic range (default off, 1-8 optional).

Shutter Speed: Active when the mode is set to manual or SAE (default 1/50, 1/25, 1/30, 1/50, 1/60, 1/90, 1/100, 1/120, 1/180, 1/250, 1/350, 1/500, 1/1000, 1/2000, 1/3000, 1/4000, 1/6000, 1/10000 available).

Bright: Set the brightness value when bright mode is active (default 11, 0-23 available).

Gain: Set the gain value, when manual or SAE modes are active (default 1, 0-20 optional)



b. Color: White balance, saturation, color, white balance, sensitivity, color temperature, gain red and blue gain can be set.

Configurations

- Audio Configure
- Video Configure
 - Video Encode
 - Stream Publish
 - RTP Multicast
 - Video Parameters
 - Video OSD
 - OSD Font Size
 - Video Out
- Network Configure
 - Network Port
 - Ethernet
 - DNS
 - GB28181
 - SRT
- Camera Configure
 - Attributes
 - Time
 - User Settings
 - Update
 - Default
 - Reboot
 - Parameter import/export

Video Parameters

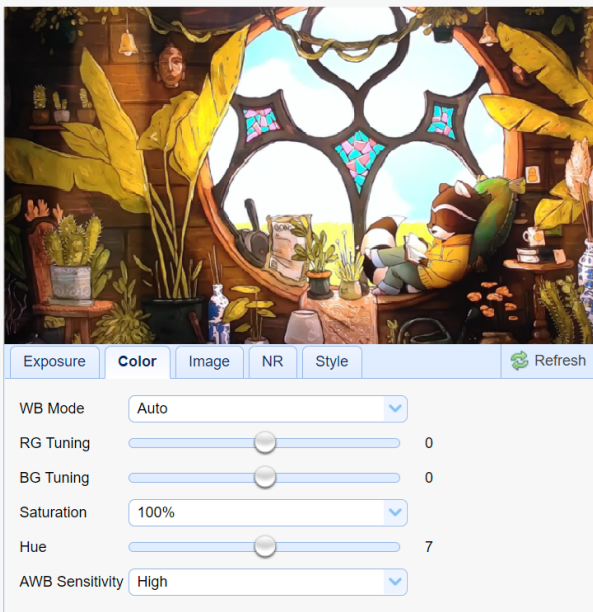

*Click the "Refresh" button to refresh parameter.

*Effective after changed parameters

White Balance Modes: Set the white balance mode (the default automatic, 2400K-7100K, manual, One-push optional).

RG Tuning: default 0, -10~10 (only available in automatic mode)

BG Tuning: default 2, -10~10 (only available in automatic mode)

Saturation: Set the saturation (default 36, 0-127 optional).

HUE: Set the chroma (default 4, 0-8 optional).

AWB Sensitivity: Set the white balance sensitivity (only available in automatic mode high/medium/low)

RG: Sets the red gain in manual mode (default 36, 0-255 optional).

BG: Sets the Blue gain in manual mode (default 36, 0-255 optional).

NOTE: Click the "Adjust" button when in One-push white balance mode to correct the image.



c. Image: Bright, contrast, sharpness, gamma, DCI, LDC, B&W mode, flip-h, flip-v, dzoom, and low-light controls.

Configurations

- Audio Configure
- Video Configure
 - Video Encode
 - Stream Publish
 - RTP Multicast
 - Video Parameters**
 - Video OSD
 - OSD Font Size
 - Video Out
- Network Configure
 - Network Port
 - Ethernet
 - DNS
 - GB28181
 - SRT
- Camera Configure
 - Attributes
 - Time
 - User Settings
 - Update
 - Default
 - Reboot
 - Parameter import/export

Video Parameters

Exposure Color **Image** NR Style Refresh

Bright 7

Contrast 7

Sharpness 4

Gamma Default

DCI OFF

LDC 4

B&W Mode Color

Flip-H OFF

Flip-V OFF

DZoom OFF

Low-Light Mode OFF

*Click the "Refresh" button to refresh parameter.
*Effective after changed parameters

Bright: Set the image brightness (default 7, 0-14 optional).

Contrast: Set the contrast (default 7, 0-14 optional).

Sharpness: Set the sharpness value (default 4, 0-15 optional).

Gamma: Gamma value setting (default, 0.45, 0.50, 0.55, 0.63 optional).

DCI: Change dynamic contrast level (default off, off-8 optional)

LDC: Change the lens distortion correction level (default 4 , off-8 optional)

B&W Mode: Set black and white mode (default color, black/white optional).

Flip-H: Flip the image horizontally (default off).

Flip-V: Flip the image vertically (default off).

DZoom: default off

Low-Light Mode: default off



d. Noise Reduction: 2D noise reduction, 3D noise reduction

Configurations

- Audio Configure
- Video Configure
 - Video Encode
 - Stream Publish
 - RTP Multicast
 - Video Parameters
 - Video OSD
 - OSD Font Size
 - Video Out
- Network Configure
 - Network Port
 - Ethernet
 - DNS
 - GB28181
 - SRT
- Camera Configure
 - Attributes
 - Time
 - User Settings
 - Update
 - Default
 - Reboot
 - Parameter import/export

Video Parameters



Exposure Color Image NR Style Refresh

NR-2D

NR-3D

Dynamic Hot Pixel

*Click the "Refresh" button to refresh parameter.

*Effective after changed parameters

2D Noise Reduction: Set 2D noise reduction level (default 2, 1-7, off, auto).

3D Noise Reduction: Set 3D noise reduction level (default 5, 1-8, off).

Dynamic Hot Pixel: Assist in removing pixels that read too bright (default off 1-5 available)

e. Style: select the picture style default, standard, clear, bright, soft or USB.

Configurations

- Audio Configure
- Video Configure
 - Video Encode
 - Stream Publish
 - RTP Multicast
 - Video Parameters
 - Video OSD
 - OSD Font Size
 - Video Out
- Network Configure
 - Network Port
 - Ethernet
 - DNS
 - GB28181
 - SRT
- Camera Configure
 - Attributes
 - Time
 - User Settings
 - Update
 - Default
 - Reboot
 - Parameter import/export

Video Parameters



Exposure Color Image NR Style Refresh

Style

*Click the

*Effective

Note: Click "Refresh" for any video parameters (a, b, c, d, e) to take effect.



5. Video OSD

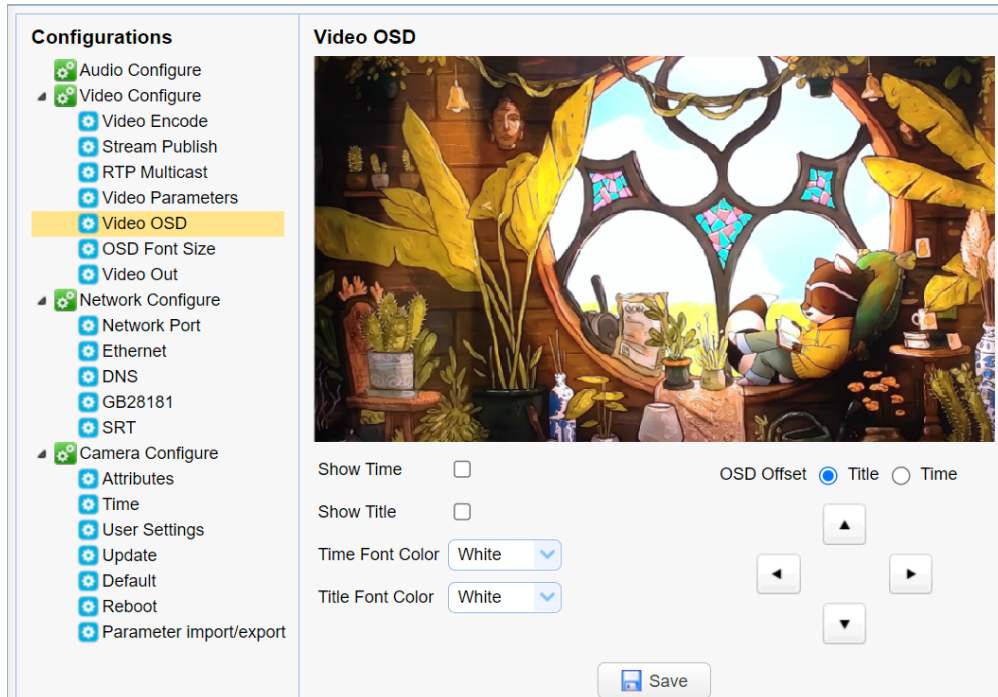

Show Time: Check to show the date and time on the image (set in Camera Configure - Time).

Show Title: Check to show the device name on the image (set in Camera Configure - Attributes).

Time Font Color: Set font color of time and date (white, black, yellow, red, and blue)

Title Font Color: Set font color of title (white, black, yellow, red, and blue).

OSD Offset and Arrow Keys. Set the display position of the date/time and title. Click on the "up, down, left, right" buttons to move the selected OSD position.

(NOTE: Click on the "Save" button for settings to take effect.)

6. OSD Font Size

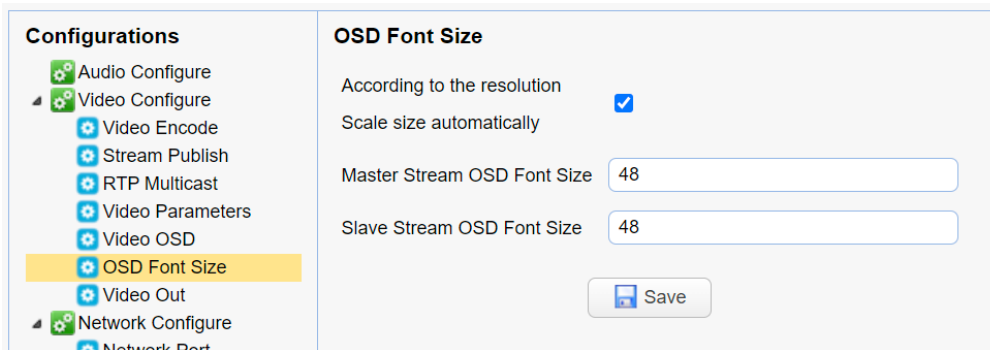

According to the resolution scale size automatically: check to enable text size scaling to auto,

Main Stream Character Size: Set the character size of the display, the device will automatically restart after changed and saved (default 48, 28-200 optional)

Secondary Stream Character Size: Set the character size of the display, the device will restart automatically after changed and saved (default 48, 28-200 optional)

(NOTE: Click on the "Save" button for settings to take effect.)



7. Video output

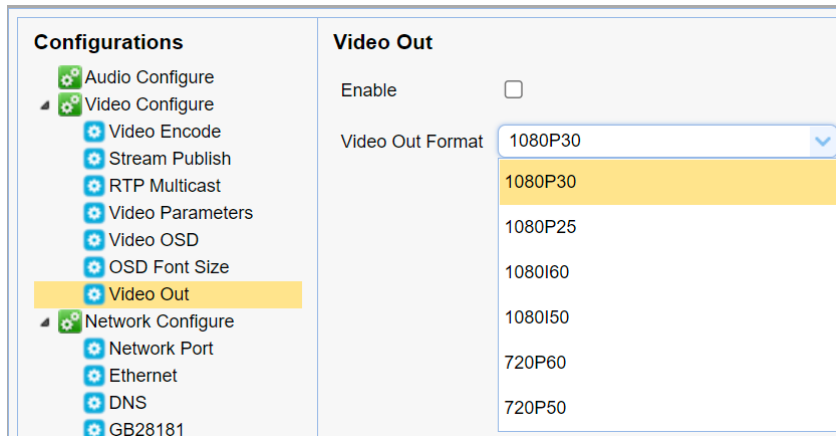

Enable: check to enable video output through the HDMI/SDI port. (OFF by default)

Output Format: 1080P30, 1080P25, 1080I60, 1080I50, 720P60, 720P50

(**NOTE:** Click on the "Save" button for settings to take effect.)

Network Configure

1. Network Port

Port Data : Set the data port, the device will restart automatically after changed (default 3000, 0-65535 optional)

Port Web: Set the Web port, the device will restart automatically after changed (default is 80, 0-65535 is optional)

Port Onvif: Set the Onvif port, the device will restart automatically after changed (default 2000, 0-65535 optional)

Port Soap: Set the Soap port (default 1936, 0-65535 optional)

Port RTMP: Set the RTMP port (default 1935, 0-65535 optional)

Port RTSP: Set the RTSP port, the device will restart automatically after changing (default 554, 0-65535 optional).

Port Visca: Set the Visca port, the device will restart automatically after changing (default 1259,0-65535 optional).

Port WebSocket: Set the WebSocket port, change and save it and restart the device to take effect (default 8088, 0-65535 optional)

(**NOTE:** Click on the "Save" button for settings to take effect.)

RTSP Obtaining method: rtsp:// device IP address: 554 / live / av0 (av0 close-up main stream, av1 close-up sub-stream, av2 panoramic main stream, av3 panoramic sub-stream, av4 broadcast code stream.)

RTMP Obtaining method: rtmp:// device IP address:1935/live/ av0 (av0 close-up main stream, av1 close-up sub-stream, av2 panoramic main stream, av3 panoramic sub-stream, av4 broadcast code stream.)



2. Ethernet Parameters

Configurations	Ethernet
Audio Configure	DHCP <input type="checkbox"/>
Video Configure	IP Address <input type="text" value="192.168.5.163"/>
Video Encode	Subnet Mask <input type="text" value="255.255.255.0"/>
Stream Publish	Default Gateway <input type="text" value="0.0.0.0"/>
RTP Multicast	MAC Address <input type="text" value="E4:77:D4:A2:DE:E3"/>
Video Parameters	<input type="button" value="Save"/>
Video OSD	
OSD Font Size	
Video Out	
Network Configure	
Network Port	
Ethernet	
DNS	

DHCP: Check to enable or disable to obtain an IP address automatically. Save changes and reboot the device to take effect (default: OFF)

IP Address: Set the IP address, save changes and reboot the device to take effect (default 192.168.5.163). **Note:** This IP address is the same one used to login to the Web Interface.

Subnet Mask: Set the subnet mask (default 255.255.255.0).

Default Gateway: Set the default gateway (default 0.0.0.0).

MAC Address: The parameter is read-only and cannot be modified.

(**NOTE:** Click on the "Save" button for settings to take effect.)

3. DNS parameters

Preferred DNS Server: Set the preferred DNS server. (Default 0.0.0.0).

Alternate DNS Server: Set the alternate DNS server. (Default 0.0.0.0).

(**NOTE:** Click on the "Save" button for settings to take effect.)

4. GB28181

Enable: Check to enable/open GB28181.

ClockSync: Check to enable time synchronization.

Video Type: select which stream type settings will be modified (main stream/secondary stream)

Registration Valid Time(s) (in seconds): 3600 Range 5-65535

Heartbeat Time (seconds): 60 Range 1-65535

Register ID: 34020000001320000001

Register User name: IPC

Register Password: 12345678

Equipment Belong: Users can add their own ID.

Administrative Region: Users can add their own.

Alarm Areas: Users can add their own.

Device Address: Users can add their own.

Local SIP Port: 5060 Range 0-65535

Server IP: IP address of the GB28181 computer/server.

Server SIP Port: 5060 Range 0-65535

Server ID: 34020000002000000001

(**NOTE:** Click on the "Save" button for settings to take effect.)



5. SRT

Port SRT: Set the SRT port (default 9000, 0-65535 optional)

Password for stream encryption: Set the SRT password. (the default is empty, the password is between 10-80 characters)

Crypto key length in bytes: Set the length of the SRT password (default 0, 16, 24, 32 optional)

(**NOTE:** Click on the "Save" button for settings to take effect.)

Camera Configure

1. Attributes

Device Name: Set the device name (default name is CAMERA-1).

Device ID: Default is 1 and is Read-Only.

System Language: Set the system language (default Simplified Chinese, English).

(**NOTE:** Click on the "Save" button for settings to take effect.)

2. Time

Date Format: Set the date format (YYYY-MM-DD, MM-DD-YYYY, or DD-MM-YYYY).

Date Separator: set the date separator ('/', '-', or '.').

Zone: Set the time zone.

Hour Type: Set the time type 24 or 12.

NTP Enable: Check to enable NTP mode.

Update Interval: Set the NTP server to automatically update the time(1-10 days). NTP Enable must be checked.

NTP Host URL: Set NTP server address or domain name (default time.nits.gov).

NTP Server Port: Sets the NTP server port (default 123).

Time Settings: Set the time setting method (Synchronize with computer time, synchronize with NTP server, and Set manually)

New Time: Time settings must be set to "Set manually" to edit

(**NOTE:** Click on the "Save" button for settings to take effect.)

3. User Settings

Authority: Set the user type (admin, User 1, User 2)

User Name: set the username for the selected authority.

Password: Set a password for the selected authority.

Confirm Password: Confirm passwords are the same.

Click the "Save" button, and the setting will take effect when the "Save successful" message pops up.

NOTE: Username and password are case-sensitive.



4. Update

Normal users can only read the camera version information but can not modify or update.

Update File: Click the "Choose File" button to browse to and select the firmware upgrade file in the pop-up window.

Click on the "Upgrade" button and the upgrade dialog will appear. The device will reboot automatically after the update completes successfully.

NOTE: Endure the power and network stay connected during this process or the upgrade will fail.

5. Default

Click the "Restore Factory Defaults" button and then click "Yes" in the pop-up window to restore the cameras' factory default settings and attributes.

6. Reboot

Click the "Reboot" button and choose "Yes" in the pop-up window, to reboot the device.

7. Parameter import/export

Click "Choose File" and click the "Import" button to import a camera configuration file. Click the "Export" button to export the camera configuration file when connected via USB.

Logout

Click the "Logout" button in the top right and select "Yes" in the pop-up window to exit the web interface.



Tracking Configuration

Follow these steps to set up tracking.

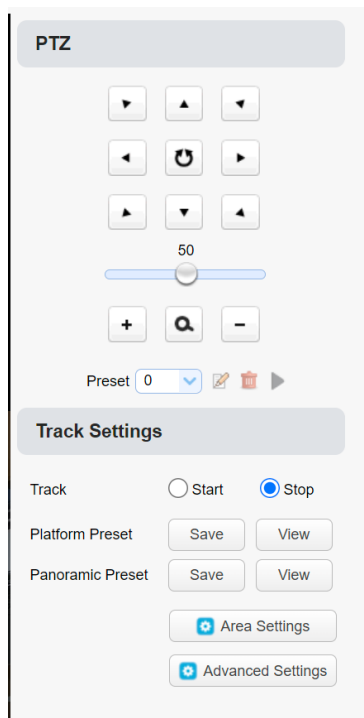

1. Click the “Stop” radial button to disable tracking and enable the “Platform Preset,” “Panoramic Preset,” and “Area Settings.”
2. Adjust the camera position and zoom using the arrow keys and for the frame the platform and then click “Save” next to “Platform Preset.”
3. Use the controls again to perform the same set up for the “Panoramic Preset” (typically a wider shot the camera uses to locate a subject should the tracking target be lost).
4. Click “Area Settings
5. Highlight the area by clicking and dragging the red box to select the platform/stage and then click the “Enable Platform Area” check box to have the camera focus on that area for tracking.
6. Click the “Mask Area” tab and select areas/objects you would like the tracking to ignore such as doorways, windows, etc.

NOTE For additional assistance please see the MAESTRO product webpage on www.bzbgear.com for video instructions.

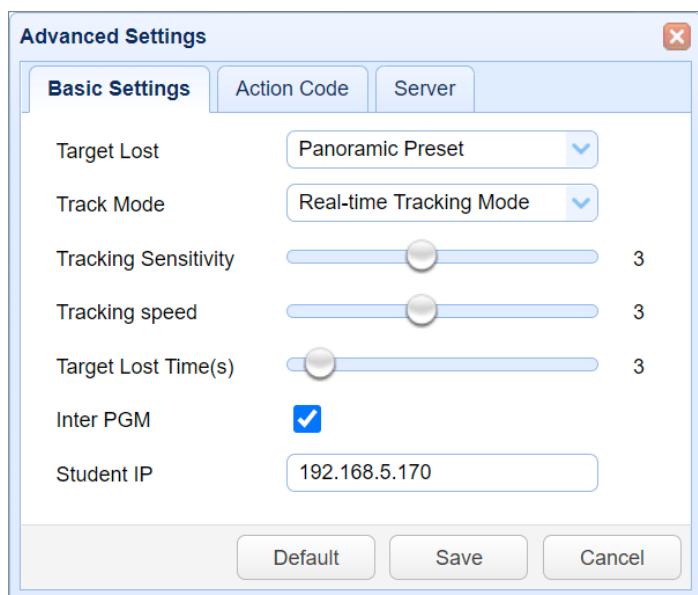

Use the “Advanced Settings” controls to manage the advanced tracking settings.

Target Lost: Lens will return to the assigned preset.

Track Mode: Real-time Tracking Mode (constantly follows target), Movie Mode (moves a frame at a time), Area Tracking Mode (camera tracking only moves after you approach the edge of the frame)

Tracking Sensitivity: The higher the sensitivity the smaller the movement needed to trigger the camera tracking movement.

Tracking Speed: How quickly the camera pans while tracking.

Target Lost Time(s): How long in seconds

for the camera to return to the selected “Target Lost” camera preset position should the tracking subject be lost.

NOTE

The Inter PGM, Student IP, Action Code and Server tabs and settings are for a more advanced setup with multiple cameras and a camera server which are not currently supported for normal use and should be disregarded.



Tech Support

Have technical questions? We may have answered them already!

Please visit BZBGear's support page (bzbgear.com/support) for helpful information and tips regarding our products. Here you will find our Knowledge Base (bzbgear.com/knowledge-base) with detailed tutorials, quick start guides, and step-by-step troubleshooting instructions. Or explore our YouTube channel, BZB TV (youtube.com/c/BZBTVchannel), for help setting up, configuring, and other helpful how-to videos about our gear.

Need more in-depth support? Connect with one of our technical specialists directly:

Phone	Email	Live Chat
1.888.499.9906	support@bzbgear.com	bzbgear.com

Warranty

BZBGear Pro AV products and cameras come with a three-year warranty. An extended two-year warranty is available for our cameras upon registration for a total of five years.

For complete warranty information, please visit bzbgear.com/warranty.

For questions, please call 1.888.499.9906 or email support@bzbgear.com.

Mission Statement

BZBGear is a breakthrough manufacturer of high-quality, innovative audiovisual equipment ranging from AVoIP, professional broadcasting, conferencing, home theater, to live streaming solutions. We pride ourselves on unparalleled customer support and services. Our team offers system design consultation, and highly reviewed technical support for all the products in our catalog. BZBGear delivers quality products designed with users in mind.

Copyright

All the contents in this manual and its copyright are owned by BZBGear. No one is allowed to imitate, copy, or translate this manual without BZBGear's permission. This manual contains no guarantee, standpoint expression or other implies in any form. Product specification and information in this manual is for reference only and subject to change without notice.

All rights reserved. No reproducing is allowed without acknowledgement.