

# BG-ADAMO-4KDA

4K UHD AUTO TRACKING HDMI 2.0/12G-SDI/USB 2.0/USB 3.0/Dante AV-H  
Live Streaming PTZ Camera with Tally Lights

## User Manual







## Table of Contents

Statement	4
Safety Precaution	4
Introduction	5
Features	5
Packing List	6
Specifications	6
Installation and Handling Caution	8
Camera Interface	8
RS-232 Interface	9
VISCA Networking	10
Mounting	10
Wall Mounting	10
Ceiling Mounting	11
Operating Instructions	12
Power on and Self-check	12
Remote	13
Remote Buttons Introduction	13
Network Connection	17
Initial Web Client Login	19
Preview	20
SD Card Recording	21
Auto-Tracking Configuration	21
Zone Tracking Setup	22
General Configuration	23
Audio Configure	24
Video Encode and Streaming	24
Video Encode	24
Video Stream Capture	25
Live Stream Publish	26
Multicast/Unicast	27
Video Parameters	28
Video OSD and OSD Font	32
Video Out	33
Network Configure	33
Network Port	33
Ethernet	34
DNS	34
GB28181, SRT, and RTSP Authentication	35
System Configure	36
System Attribute, System Time, & System User	36
Auto Reboot	37



Operation System	38
Update, Default, & Reboot	38
Dante	39
Serial Port Communication and Control	42
VISCA Protocol List	42
VISCA Protocol Return Command	42
VISCA Protocol Control Commands	42
VISCA Protocol Inquiry Commands	46
Pelco-D Protocol Command List	49
Pelco-P Protocol Command List	50
Maintenance and Troubleshooting	51
Tech Support	52
Warranty	52
Mission Statement	52
Copyright	52

## Statement

---

Please read these instructions carefully before connecting, operating, or configuring this product. Please save this manual for future reference.

## Safety Precaution

---

- To prevent damaging this product, avoid heavy pressure, strong vibration, or immersion during transportation, storage, and installation.
- The housing of this product is made of organic materials. Do not expose to any liquid, gas, or solids which may corrode the shell.
- Do not expose the product to rain or moisture.
- To prevent the risk of electric shock, do not open the case. Installation and maintenance should only be carried out by qualified technicians.
- Do not use the product beyond the specified temperature, humidity, or power supply specifications.
- Wipe the lens with a soft, dry cloth when cleaning. Wipe it gently with a mild detergent if needed. Do not use strong or corrosive detergents to avoid scratching the lens and affecting the image.
- This product does not contain parts that can be maintained or repaired by users. Damage caused by dismantling the product without authorization from BZBGear is not covered under the warranty policy.
- Installation and use of this product must strictly comply with local electrical safety standards. The power supply of the product is  $\pm 12V$ , and the max electrical current is 2A.
- Electromagnetic fields at specific frequencies may affect the video image.



## Introduction

---

The BZBGear BG-ADAMO-4KDA is an ultra-high-definition PTZ camera that delivers 4K resolution video at 60fps Available with either the 12x optical zoom lens with an 80.4° wide-angle, or the 25x optical zoom lens with a 59° wide-angle. Featuring USB 2.0, USB 3.0, LAN/Dante AV-H, HDMI, and 12G-SDI, video connections. The integration with Dante AV-H technology enables the BG-ADAMO-4KDA to distribute the stream audio and video to multiple devices on the network using nothing more than a simple Ethernet connection. The innovative auto-tracking software is intuitively designed for ease-of-use with two modes (presenter and zone) for exceptional results.

## Features

---

- **4K UHD Resolution:** The SONY CMOS sensor captures images in resolutions up to 3840x1260 with a frame rate of up to 60fps.
- **Interfaces / Multiple Simultaneous Streaming Outputs:** With a variety of outputs such as HDMI 2.0, 12G-SDI, USB3.0, USB 2.0, and LAN/Dante AV-H, the ADAMO can simultaneously broadcast multiple streams to multiple outputs.
- **Optical Zoom Lens:** The ADAMO features either a 12X optical zoom 80.4°wide-angle lens or 25X optical zoom 59°wide-angle lens.
- **Multiple Audio/Video Compression Standards:** H.264/H.265 video compression is supported by the LAN/Dante AV-H interface, USB 3.0 supports YUY2, and USB 2.0 supports MJPG, H.264, YUY2, NV12, H.265. USB 3.0 supports YUY2. The A-IN supports AAC audio compression coding.
- **Advanced Auto Focusing Algorithm:** The lens promptly snaps into focus with dependable accuracy and stability.
- **Low Noise and High SNR:** A high SNR (Signal to Noise Ratio) image is achieved using low noise CMOS sensors. The sophisticated 2D and 3D noise reduction technology further reduces the noise while ensuring high image clarity, even in low light.
- **Supported Network Protocol:** Dante AV-H, ONVIF, GB/T28181, RTSP, RTMP.
- **Control Options:** RS232, RS485, LAN, or IR remote control. Protocols include VISCA, PELCO-P/D, ONVIF, and VISCA over IP.
- **Multiple Presets:** Configure up to 255 presents using the Web GUI, or 10 presents via the IR remote control.
- **Two Auto-Tracking Modes:** Presenter mode continuously tracks keeping the subject perfectly framed. Zone mode holds the frame in predetermined zones. The camera tracks and moves only when the subject has left one zone and entered the next, then holds the frame in the new zone.



## Packing List

- 1 x BG-ADAMO-4KDA
- 1 x IR Remote Control
- 1 x 12V/1.5A Power Supply
- 1 x RS232 Control Cable
- 1 x User Manual

## Specifications

Camera Parameters		
Optical Zoom	12X f=3.85 mm ~ 43.06 mm ±5%	25X f=6.91 mm ~ 214.64 mm ±5%
View Angle	Horizontal: 7.59° (N) ~ 80.4° (W) Vertical: 4.6° (N) ~ 50.0° (W)	Horizontal: 1.98° (N) ~ 59° (W) Vertical: 1.12° (N) ~ 34.14° (W)
Iris Value	F1.8(Wide) ~ F3.56(Tele) ±5%	F1.35(Wide) ~ F4.6(Tele) ±5%
Sensor	1/2.5 inch SONY CMOS sensor	1/1.8 inch SONY CMOS sensor
Effective Pixels	8.51M megapixel 16:9	
Video Format	HDMI : 3840*2160P60/50/30/25/59.94/29.97;1080P60/50/ 30/25/59.94/29.97;1080i60/50/59.94; 720P60/50/59.94 SDI : 3840*2160P60/50/30/25/59.94/29.97;1080P60/50/ 30/25/59.94/29.97;1080i60/50/59.94; 720P60/50/59.94 USB 2.0: MJPG : 3840*2160/1920*1080/1280*720 /1024*768 /1024*576/800*600/720*576/720*480/704*576/640*480 /640*360 /352*288/320*240P30 H264 : 3840*2160/1920*1080/1280*720 /1024*768 /1024*576/800*600/720*576/720*480/704*576/640*480 /640*360 /352*288/320*240P30 H.265 : 1920*1080/1280*720 /1024*768 /1024*576/800*600/720*576/720*480/704*576/640*480 /640*360 /352*288/320*240P30; YUY2 : 800*448 /720*480P25; 640*360 /432*240P30 NV12 : 800*448P25; 640*480 /640*360 /432*240P30 USB 3.0: YUY2 : 1920*1080 /1280*720P60/50/30/25; 960*540 /800*600P30; 720*576P50; 720*480P60;640*480P30;	
Minimum Illumination	0.5Lux (F1.8, AGC ON)	
DNR	3D DNR	
White Balance	Auto / Manual/ One Push/ Specified Temperature	
Focus	Auto/Manual/One Push Focus	
Exposure Mode	Auto/Manual/Shutter priority/Aperture priority/brightness priority	
Aperture	F1.8 ~ F11 CLOSE	
Shutter Speed	1/25 ~ 1/10000	
BLC	ON/OFF	
Video Adjustment	Brightness, Color, Saturation, Contrast, Sharpness, B/W mode, Gamma curve	
SNR	≥50dB	



Interface	
Product Interfaces	HDMI, 12G-SDI, LAN/Dante AV-H (supports PoE), USB 2.0, A-IN, USB 3.0, SD (FAT32), RS232-IN, RS232-OUT, RS422 (compatible with RS485), DC12V, Power Switch
Video Compression Format	LAN Interface: H.264, H.265 USB 2.0 Interface: MJPG, H264, YUY2, NV12 USB3.0 Interface: YUY2
Audio Input Interface	Stereo 3.5mm AUX
Audio Output Interface	HDMI, LAN, 12G-SDI, USB 2.0, USB 3.0
Audio Compression Format	AAC
Network Interface	10M/100M/1000M adaptive Ethernet port, PoE power supply, audio and video output
Network Protocols	Dante AV-H, RTSP, RTMP, ONVIF, GB/T28181; VISCA IP control protocol
Control Interface	RS232-IN, RS232-OUT, RS422 compatible with RS485, LAN
Serial Communication Protocol	VISCA/Pelco-D/Pelco-P; Baud Rate: 115200/38400/9600/4800/2400
USB Communication Protocol	UVC (Video)
Power Interface	HEC3800 outlet (DC12V), PoE
Supply Adapter	AC110V~AC220V to DC12V/2.5A
Input Voltage	DC12V±10%
Input Current	<1.5A
Power Consumption	<12W
PTZ Parameters	
Pan Rotation	-170°~+170°
Tilt Rotation	-30°~90°
Pan Control Speed	0.1°/s ~ 100°/s
Tilt Control Speed	0.1°/s ~ 70°/s
Preset Speed	Pan: 78.8°/s, Tilt: 31.7°/s
Preset Number	255 presets via Web GUI (10 presets using remote control)
Other Parameters	
Stored Temperature	-10°C~+60°C
Storage Humidity	20%~95%
Working Temperature	-10°C~+50°C
Working Humidity	20%~80%
Dimension	220(L)mm*150.2mm(W)*177.5mm(H)
Weight	~4 Lbs
Application	Indoor



## Installation and Handling Caution

- Do not manually rotate the camera head as it could cause mechanical failure.
- Place the camera on a stable table or horizontal surface. Installing on a slanted surface will result in a slanted image.
- Do not place obstacles within the camera's rotation circumference.
- For proper operation and synchronization, do not power the camera on until the cable installation has been completed.

## Camera Interface

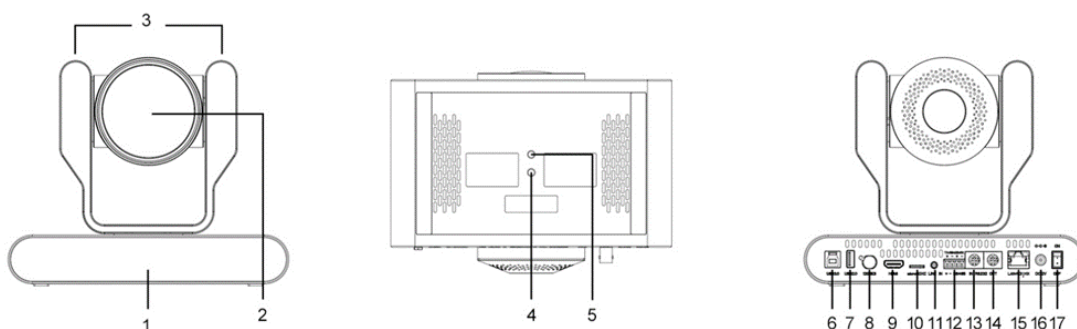

1. Remote-control IR Indicator	7. USB 2.0	13. RS232 Control Interface (In)
2. Camera Lens	8. 12G-SDI Output	14. RS232 Control Interface (Out)
3. Tally Lights	9. HDMI Output	15. LAN/PoE
4. Mounting Hole	10. Micro SD slot	16. DC12V Power Input
5. Screw Hole for Tripod	11. Audio Input	17. Power Switch
6. USB 3.0	12. RS422/RS485 Interface	

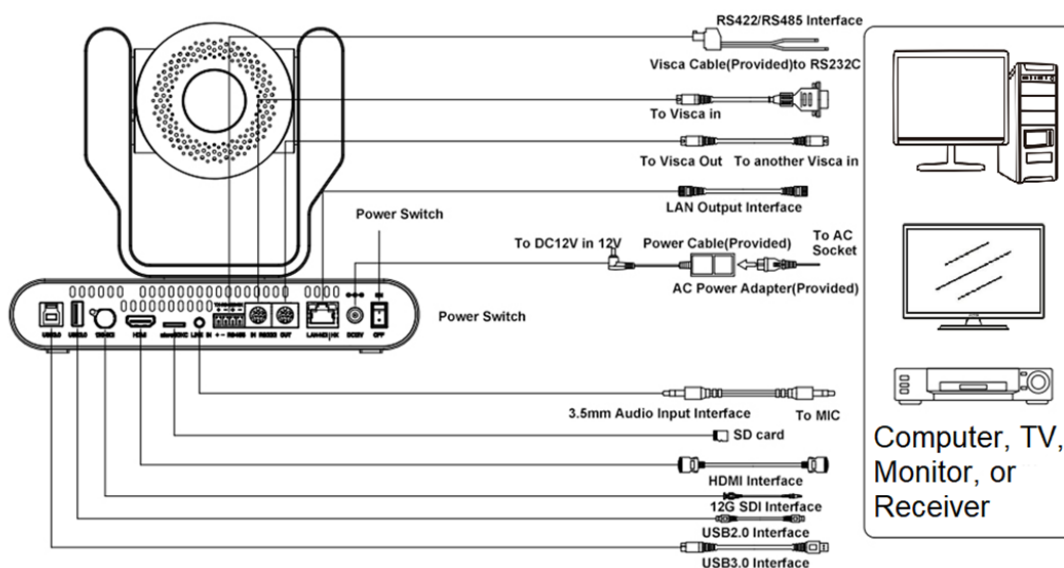





**RS-232 INTERFACE**

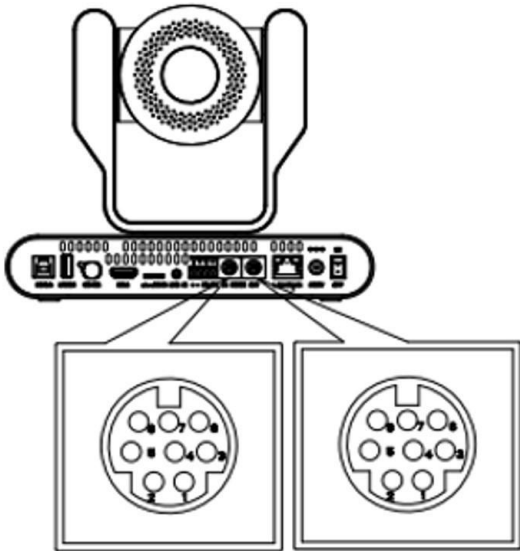
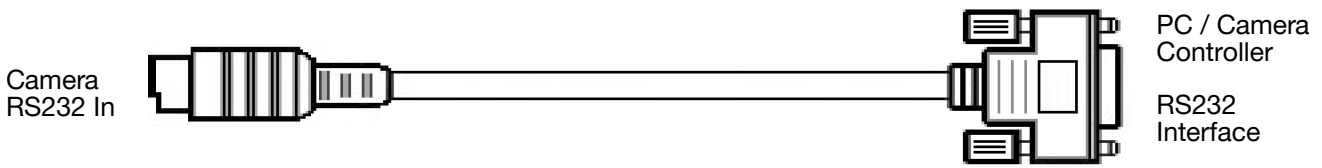

**Connection to PC or Camera Controller**

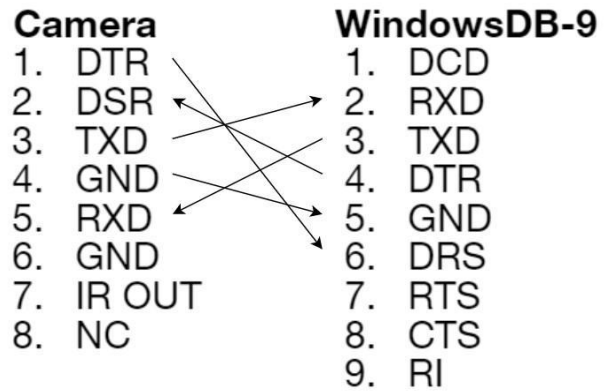

**RS-232 Mini-DIN 8-pin Port Definition**

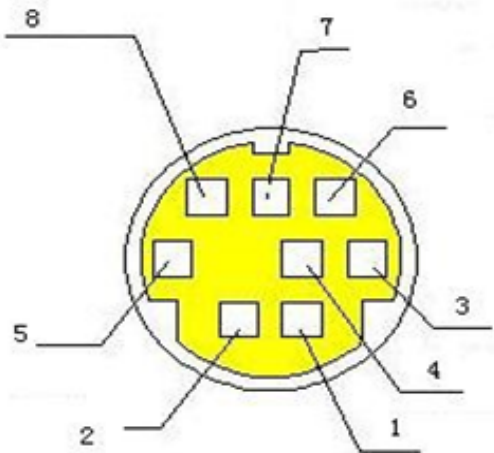

NO.	Port	Definition
1	DTR	Data Terminal Ready
2	DSR	Data Set Ready
3	TXD	Transmit Data
4	GND	Signal Ground
5	RXD	Receive Data
6	GND	Signal Ground
7	IR OUT	IR Commander Signal
8	NC	No Connection



### RS-232 (BD9) Port Connections

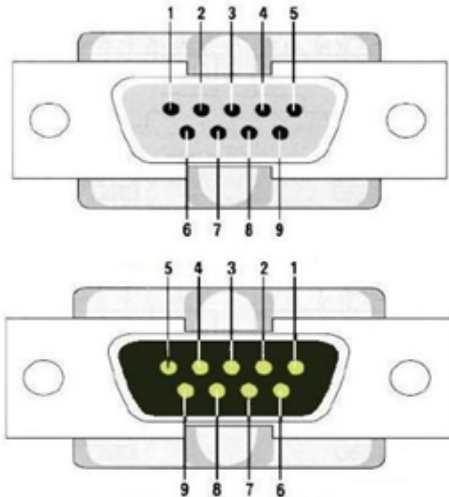

NO.	Port	Definition
1	DCD	Definition
2	RXD	Data Carrier Detect
3	TXD	Receive Data
4	DTR	Transmit Data
5	GND	Data Terminal Ready
6	DSR	System Ground
7	RTS	Data Set Ready
8	CTS	Request to Send

## VISCA Networking

### Camera cascade connection

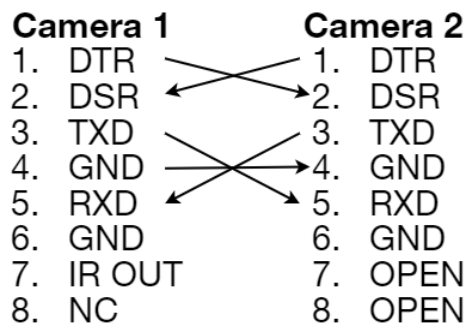

## Mounting

Note: Ceiling or wall mounting brackets should be mounted to a wooden or concrete wall. Mounting to plasterboard is not recommended for safety reasons.

### Wall Mounting



Anti-vibrate Cushion



Limited Post



1/4-20UNC Bolt



M6 Nut and Shim



M6 Swelling Bolts



Wall Mounting Bracket



Camera

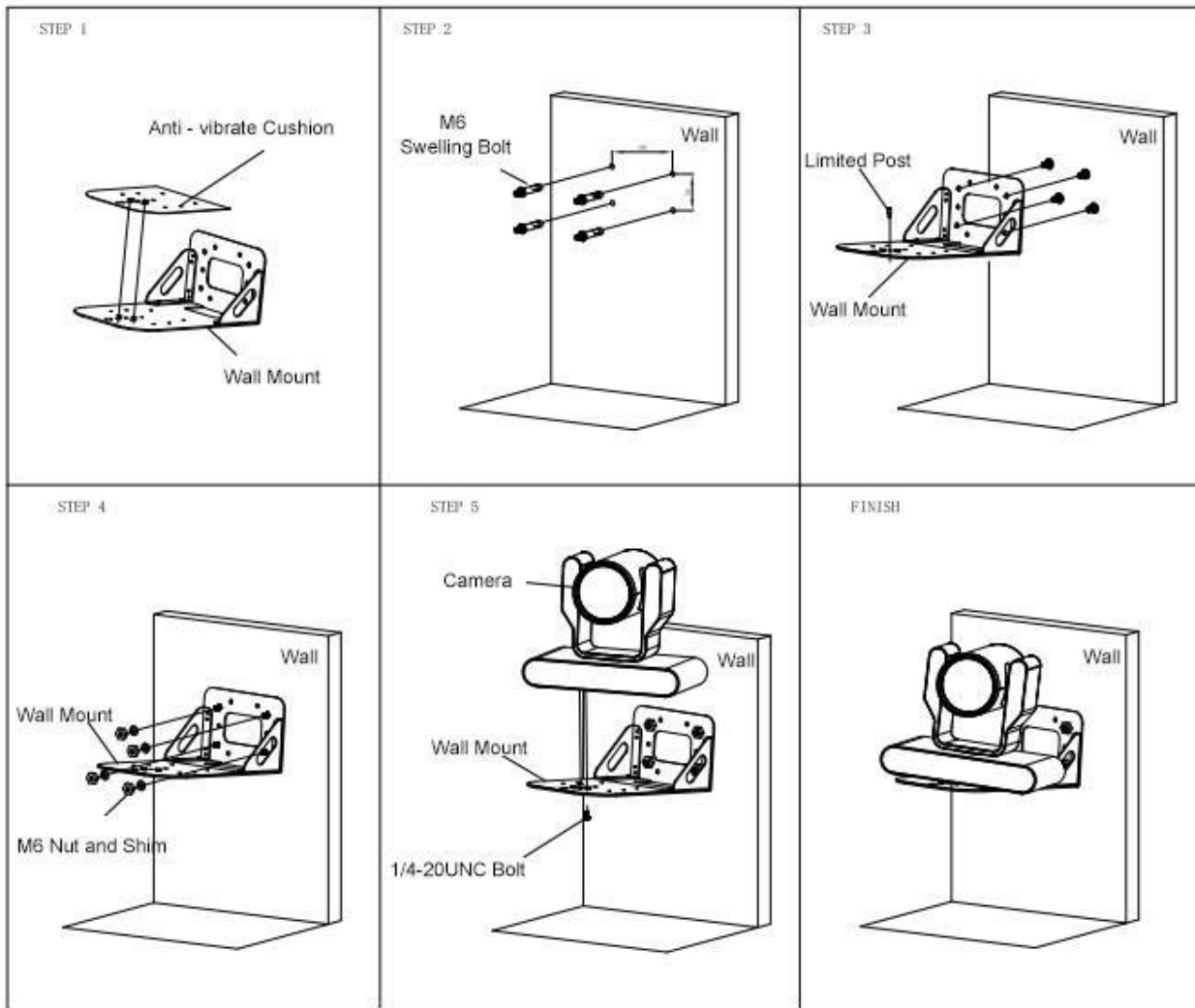

## Ceiling Mounting

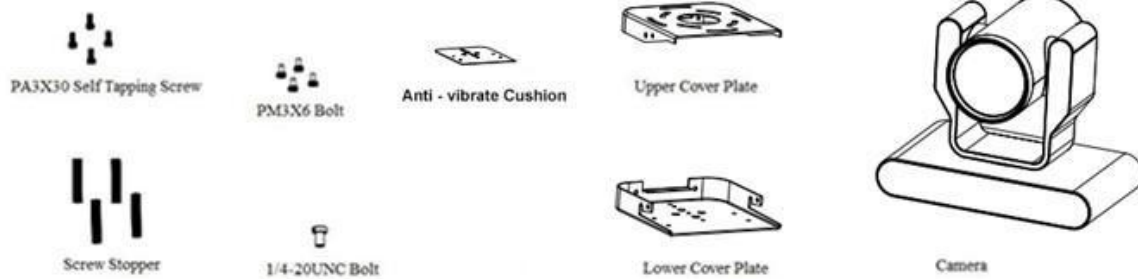

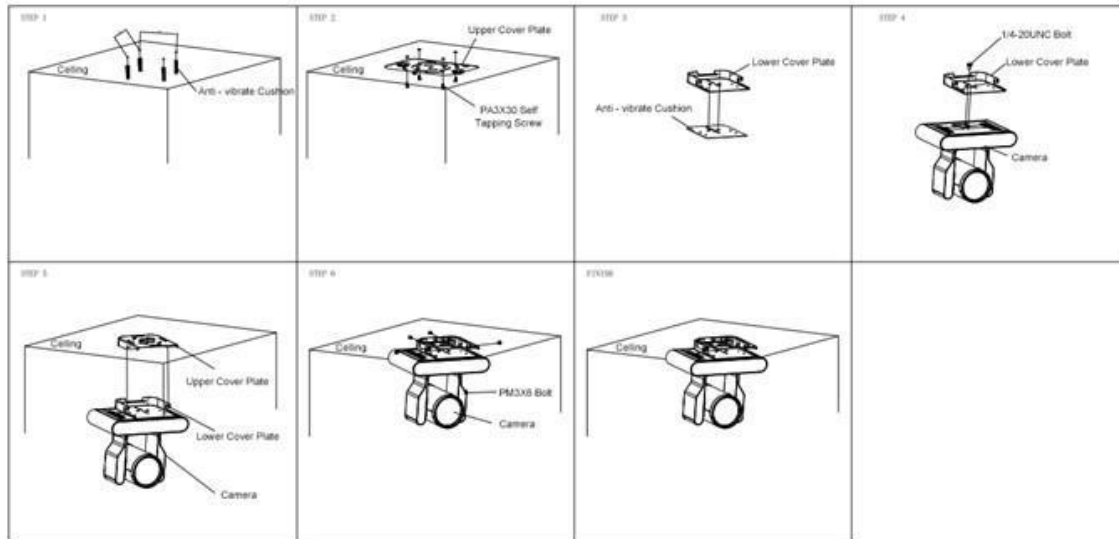

## Operating Instructions

### POWER ON AND SELF-CHECK

1. Power-on: Connect the DC12V power adaptor to the power supply socket on the back of the camera. or connect to a PoE enabled network switch using a category cable.
2. Camera Self-check: The remote-control IR indicator and tally lights will flash when powered on. The camera will pan-tilt to the lowest left position, then return to the HOME position (both the horizontal and vertical positions are in the middle). The lens/zoom will move through its complete range. Once the remote-control IR indicator and tally lights stop flashing, the self-check has been completed.

#### Notes:

1. After the power-on and self-check, the camera will automatically return to the preset 0 position.
2. The factory default address for the IR remote-control is #1.



## REMOTE



### One-to-One Code Matching:

Out of the box the remote is automatically paired with the camera. Should the camera need to be re-pair with the remote, perform the steps below.

1. Press the "set" and " \* " keys combined for 3 seconds. The LED indicator will start flashing.
2. The camera will receive the signal and power on if not already on.
3. The LED indicator will turn off if the code matching is successful.

If the one-to-one code matching has failed, the LED indicator will flash for 20 seconds and turn off. The camera will stop code matching and go into sleep mode. Press any key to wake the camera up and reattempt code matching.

## REMOTE BUTTONS INTRODUCTION

In this manual, "press the button" means a click rather than a "press and hold". Special instructions will be given if pressing and holding the button for more than one second is required. When a button-combination is required, perform the actions in sequence.

For example, **[\*]+[#]+[F1]** means press "**[\*]**" first, then "**[#]**" and press "**[F1]**" last.

### 1. Camera Remote Control Address Setting



- [\*]+[#]+[F1]**: Camera Address No.1
- [\*]+[#]+[F2]**: Camera Address No. 2
- [\*]+[#]+[F3]**: Camera Address No. 3
- [\*]+[#]+[F4]**: Camera Address No. 4



## 2. Camera Selection

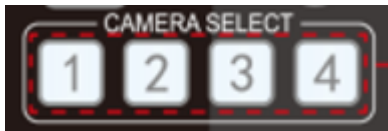

Select the camera's address to control it.

## 3. Pan/Tilt Control



**Up:** press ▲                      **Down:** press ▼  
**Left:** press ◀                      **Right:** press ▶  
 Return to middle position: press [HOME]

Press and hold the up, down, left, or right button to pan/tilt the camera. The camera will continue to move in the arrow direction until either the button is released or the camera has reached its full range of motion.

## 4. Focus Control and Zoom

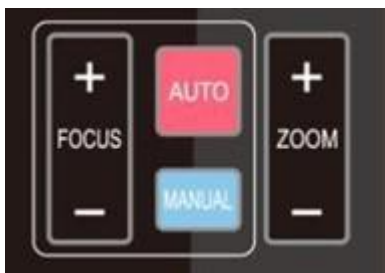

**FOCUS + (near) :** Press to adjust the lens focus.

**FOCUS - (far) :** Press to adjust the lens focus.

**MANUAL :** Press to enter manual focus mode.

**AUTO :** Press to return to auto focus mode.

**ZOOM + :** Press to zoom in.

**ZOOM - :** Press to zoom out.

## 5. Set and Clear Presets



**Set Preset:** Press the [SET PRESET] button, then press the number buttons 0-9 to set the preset positions.

**Note:** 10 presets are available via remote control.

**Call Preset:** Press the 0-9 number buttons to call a preset position.

**Clear Preset:** Press the [CLEAR PRESET] button, then press the desired number button to clear its preset position.

**BLC ON/OFF:** Turn on/off the BLC.

**Menu:** Enter/Exit OSD menu or return to the previous menu.

**Note:** Pressing the [#] key three times in a row will clear all presets.





## 6. Auto Tracking Buttons



**F1:** Turn off auto tracking

**F2:** Turn on auto tracking

**F3:** Switch auto tracking modes

**F4:** Switch auto tracking to follow a different person

## 7. Key Combinations

**【#】+【#】+【#】:** Cancel all preset positions

**【\*】+【#】+【3】:** The menu is set to Chinese

**【\*】+【#】+【9】:** Toggle forward and backward

**【#】+【\*】+ Auto :** Stop demo mode

**【#】+【#】+【0】:** Switch video format 4KP60

**【#】+【#】+【2】:** Switch video format 4KP30

**【#】+【#】+【4】:** Switch video format 1080P60

**【#】+【#】+【6】:** Switch video format 1080I60

**【#】+【#】+【8】:** Switch video format 1080P30

**【\*】+【#】+【6】:** Restore factory image defaults

**【\*】+【#】+【4】:** The menu is set to English

**【\*】+【#】+ Auto:** Enter Demo mode

**【\*】+【\*】+【7】:** Turn on green tally light

**【\*】+【\*】+【8】:** Turn on red tally light

**【\*】+【#】+ Manual:** IP, username, password restore to default

**【#】+【#】+【1】:** Switch video format 4KP50

**【#】+【#】+【3】:** Switch video format 4KP25

**【#】+【#】+【5】:** Switch video format 1080P50

**【#】+【#】+【7】:** Switch video format 1080I50

**【#】+【#】+【9】:** Switch video format 1080P25

**【\*】+【\*】+【1】:** Enable DHCP

**【\*】+【\*】+【2】:** Disable DHCP

**【\*】+【\*】+【3】:** Display current IP address

**【\*】+【\*】+【4】:** Reboot camera

**【\*】+【\*】+【5】:** Start recording to SD card

**【\*】+【\*】+【6】:** Stop recording to SD card

**【\*】+【\*】+【9】:** Turn off tally light



## 8. Main Menu

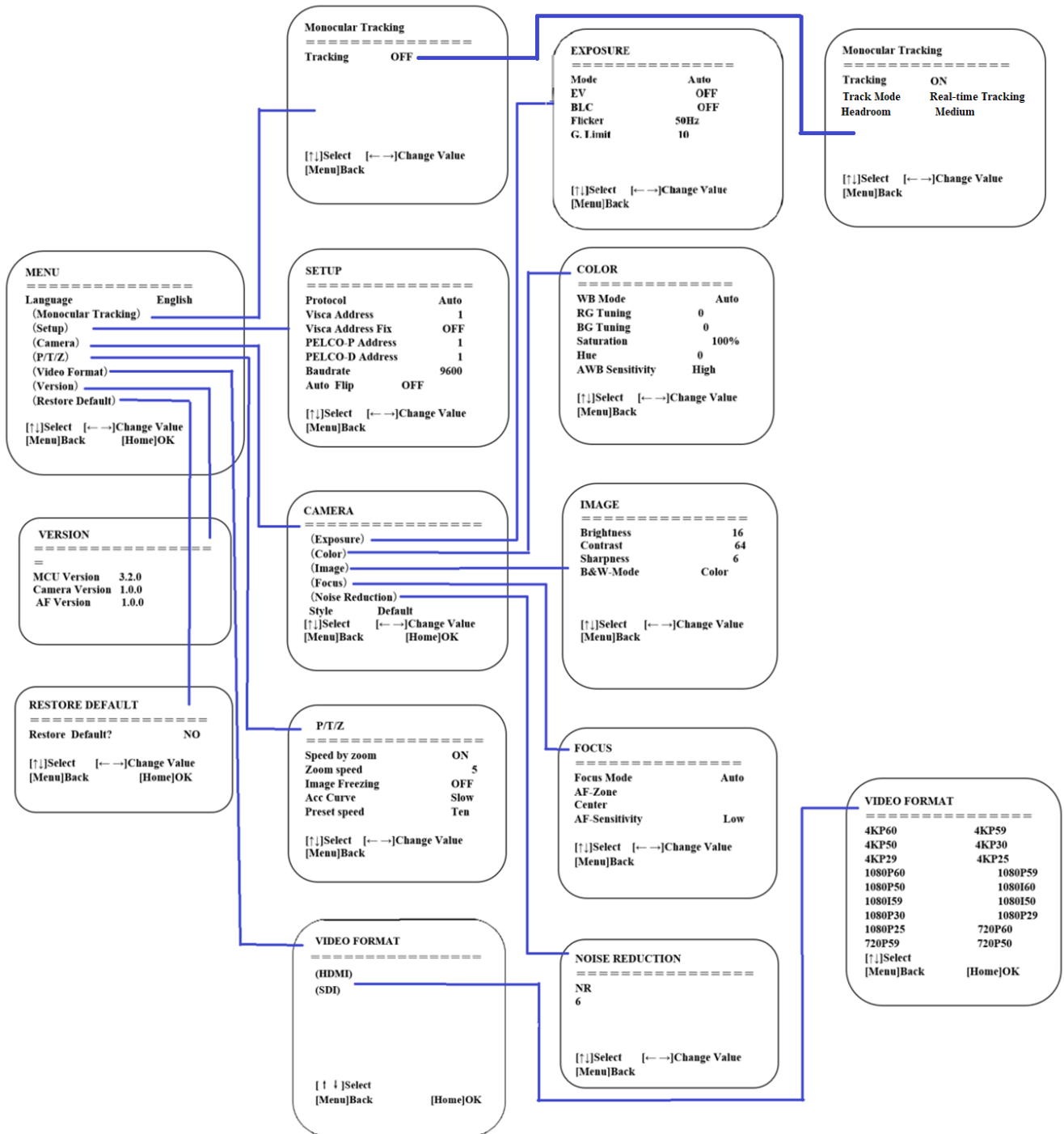





## Network Connection

### Connection Mode

- **Direct Connection:** Connect the camera directly to the computer using an ethernet cable.
- **Internet Connection:** Connect the camera and computer to a router or switch and access via the local area network (LAN).

**Note:** Ensure power and network connections are secured to prevent video issues caused by poor connection quality.

The computer must be on the same subnet as the camera to connect successfully. The device will not be accessible otherwise. The camera's default IP address is 192.168.5.163, therefore the computer must be connected to the 192.168.5.x subnet.

- To connect to the camera, open the Local Area Connection Properties on the computer.
- For Windows 10/11 users in the Start menu type/search for **“View Network Connections”**

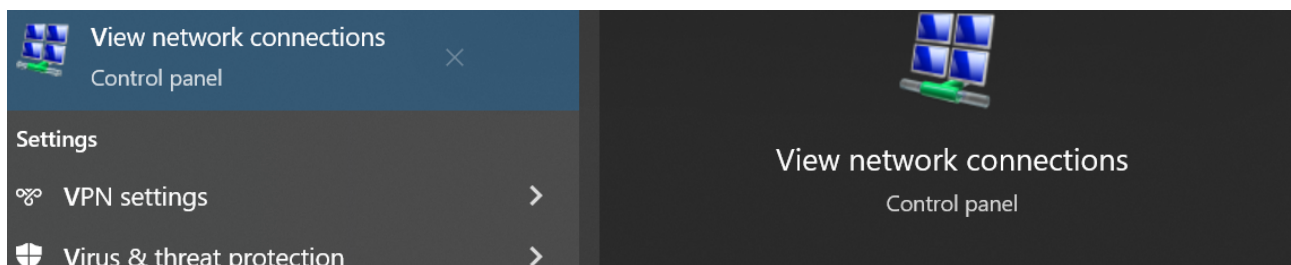

- Right-click on your connection and select **“Status”**.

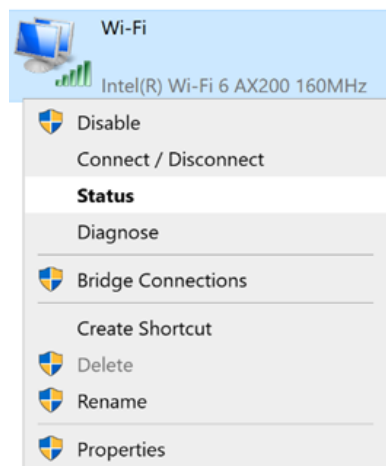

Then click **“Details...”** Take note of your current IPv4 Address and Default Gateway as you will need this information later. Close the “Details” and “Status” windows.



- Right-click on your adapter again (Wi-Fi or Ethernet) and select “**Properties**”.

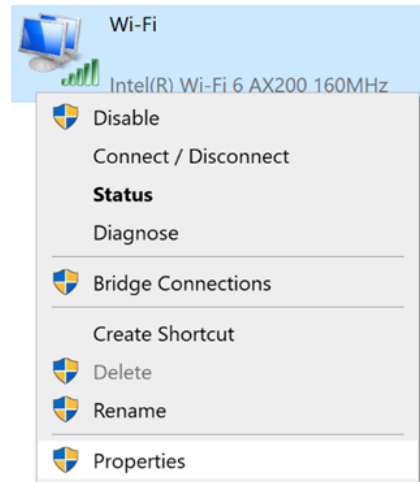

- Select “**Internet protocol version 4 (TCP/IPv4)**” as shown below and click “**Properties**”.

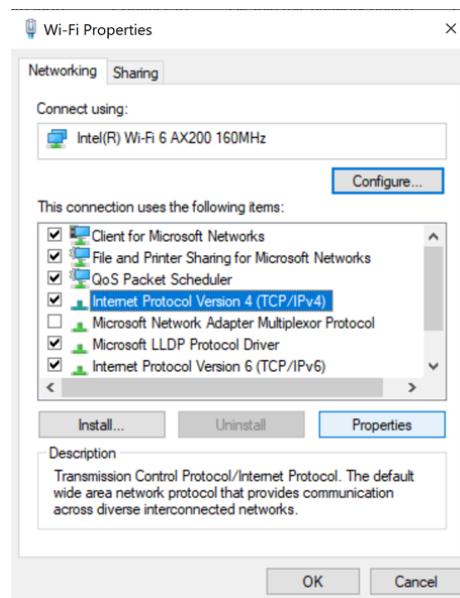

For the following steps refer to the diagram below.

- Click on the bubble for “**Use the following IP address**”
- In the IP address field, enter a non-conflicting IP address on the same subnet as the camera. If there is another device with the same IP address, you will not be able to connect. In the example below uses 192.168.5.200
- In the **Subnet mask** field enter 255.255.255.0
- In the **Default gateway** field type 192.168.5.1
- Leave the DNS fields blank.
- Click “**OK**” to apply the settings.

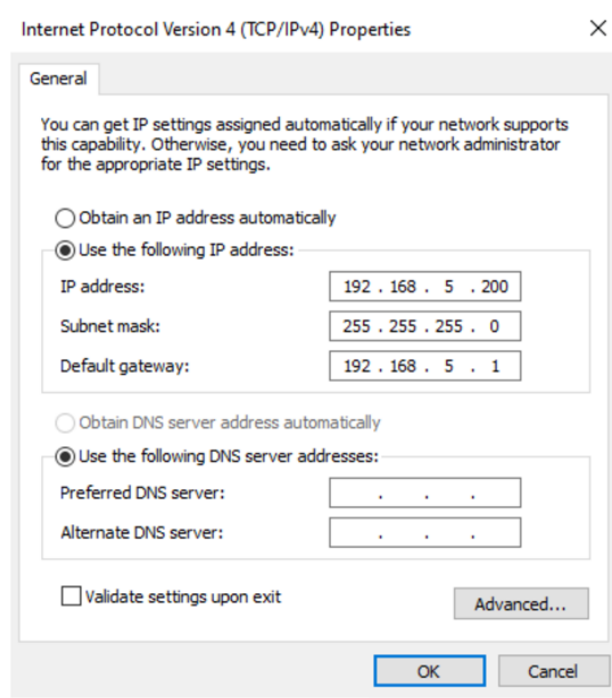

## Initial Web Client Login

- Enter 192.168.5.163 in the address bar of your internet browser and click “Enter”. Login as the administrator (Default Username/Password: admin). Users can preview and configure in the Web Client.
- When logged in as a normal user (Default Username/Password: user1 or user2), users can only preview with no options for configuration.

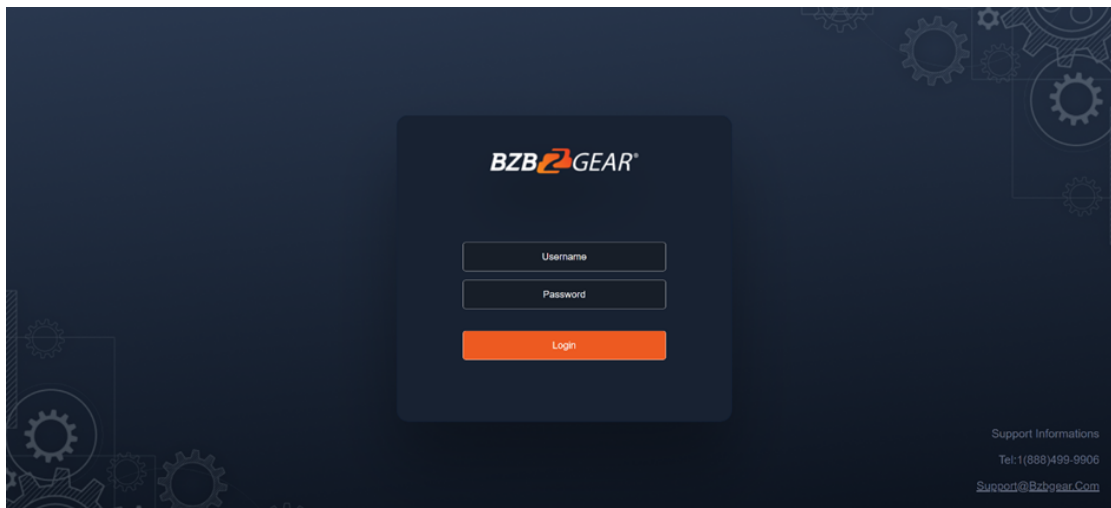



- Navigate to Configuration in the top left corner of the screen. Click “Ethernet” on the left-hand side.

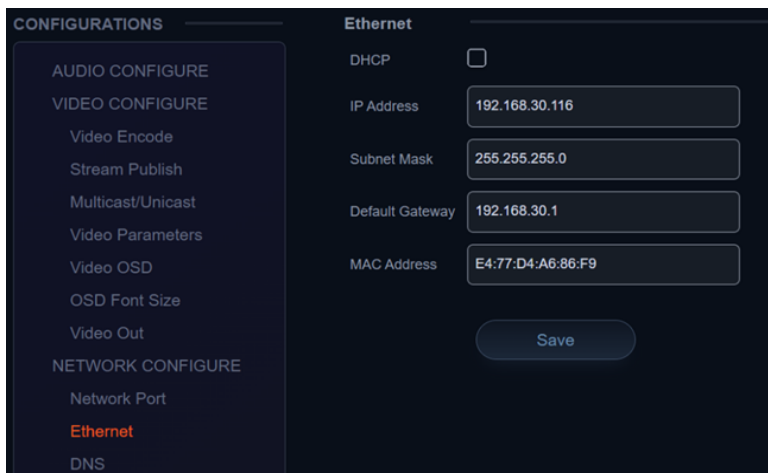

- Enter an unused IP address on your network.

**Note:** You should have your specific network information from the “Status” and “Details” pages of your internet connection noted above.

- In this example we will use 192.168.30.116
- Change the Subnet Mask to 255.255.255.0
- Default gateway of your network
- Click “Save”
- Reboot the Camera
- Once you have completed the camera network setup, repeat the steps on your computer to adjust the “Internet Protocol Version 4 (TCP/IPV4) Properties.” Select the bubbles to “Obtain an IP address automatically” and “Obtain DNS server address automatically.”

## Preview

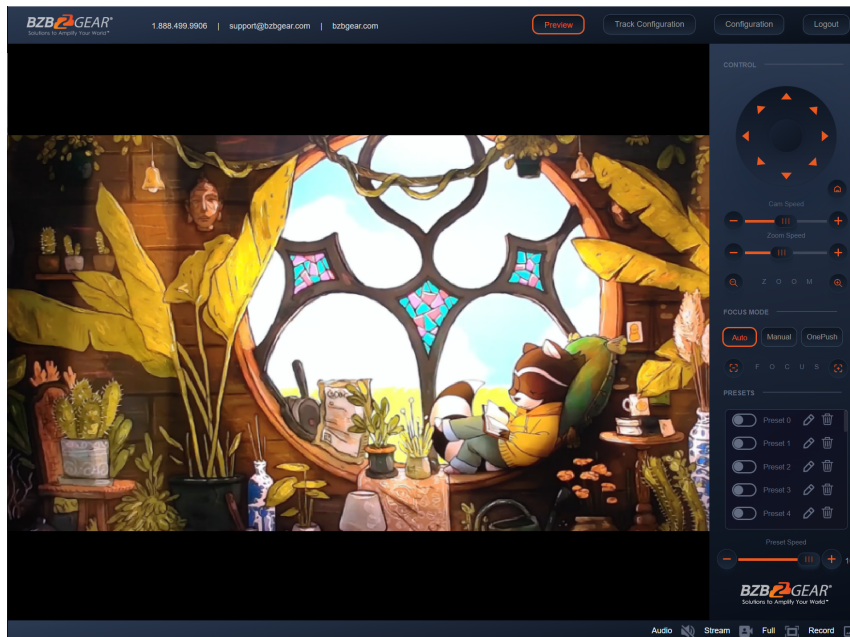

After successfully logging into the management interface, the web portal will enter the “Preview” tab. In Preview, users can control pan/tilt, zoom, focus, video capture, sound, focus, full screen preview, as well as set and recall preset positions and configure the “Home” preset position.



## SD Card Recording

- The recording option will appear in the bottom right corner of the “Preview Screen” after a compatible SD card is inserted into the camera.
  - The BG-ADAMO line of cameras currently only supports FAT32 format at this time. Before recording, ensure the SD card has been formatted properly.
- The BG-ADAMO is capable of using micro SD cards up to 1Tb when properly formatted.
  - **Note:** If your SD card does not allow you to format it to FAT32 a program such as “rufus-3.21.exe” may be required.
  - **Note:** FAT32 only allows for file sizes up to 4Gb so longer/higher resolution recordings may be broken up into several files.
- Recording parameters are changed by editing the Video Encode “Main Stream” settings.
- Synchronize the camera time before recording as file names will be generated based on system time.
- **WARNING!** Be careful when inserting a Micro SD card into the unit as there is an air gap above the SD socket and it may be possible to push a SD card into the housing if not properly inserted.

## Auto-Tracking Configuration

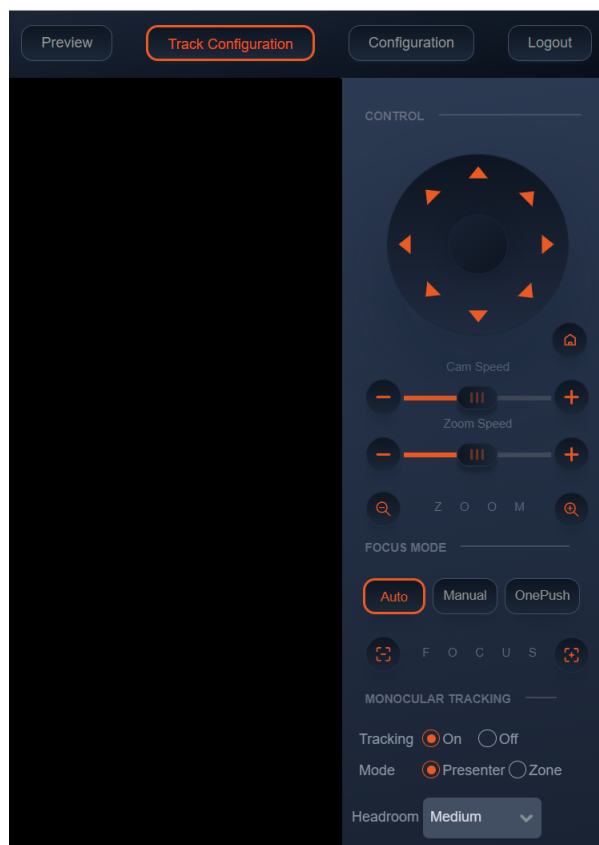

To set up or enable auto-tracking, select “**Track Configuration**” on the top right corner.

Select “**On**” under the option for Monocular Tracking.

You have 2 modes for tracking:

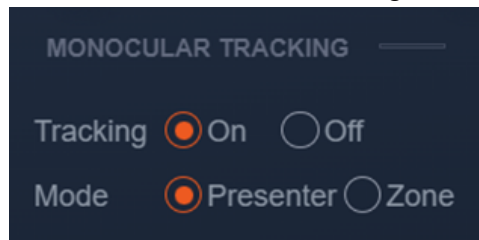

**Presenter:** The camera will continuously follow the subject until either the subject moves beyond the camera’s physical range of motion, a new more prominent target is in frame, or the tracking is disabled.

**Headroom:** Select from Low, Medium (default), or High settings to adjust space the tracking subject (only available in Presenter mode)

**Zone:** The camera holds its frame in predetermined zones. The camera tracks and moves only when the subject has left one zone and entered the next, then holds the frame in the new zone. If the subject exits the preset zones entirely, the camera will reset to the first zone or the Tracking Lost Preset if it was configured. The minimum zone allowance is 2 and the maximum is 4 zones. The zone size limits are  $-170^{\circ} \sim +170^{\circ}$  horizontal, and  $-30^{\circ} \sim +90^{\circ}$  vertical. See the next section “Zone Tracking Setup” for instructions.



## ZONE TRACKING SETUP

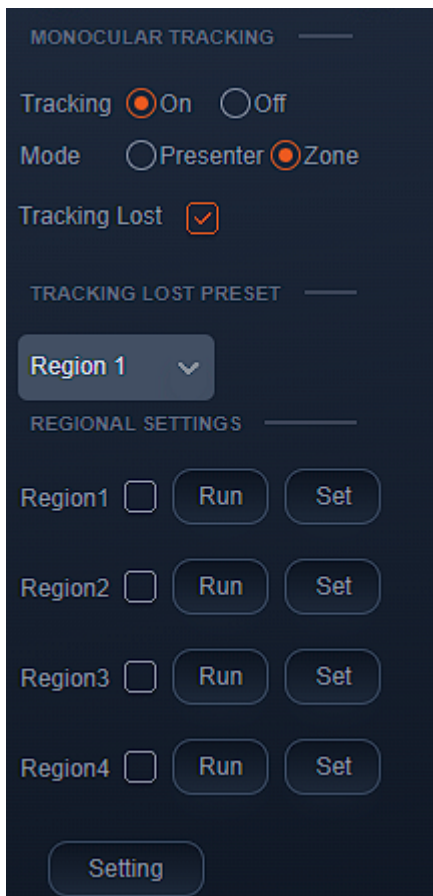

- Zone tracking must be set up using the web interface. However, it can be activated using the remote once the setup process has been completed.
- Using either the remote or web interface, adjust the camera to the desired shot.
- Select “Set” to save the shot on the desired region.
- Preset images will be shown below the preview image.
- Click the Check box on the region to enable tracking for the new zone and to save the preset.
- For zone tracking to work perform the steps again for at least 1 more region up to a total of 4.
- Use the “Tracking Lost Preset” to configure which region or Home position the camera will return to if tracking is lost.

**Note:** Each preset preview image must be continuous from left to right and overlap when setting the tracking regions. See the picture below for an example:

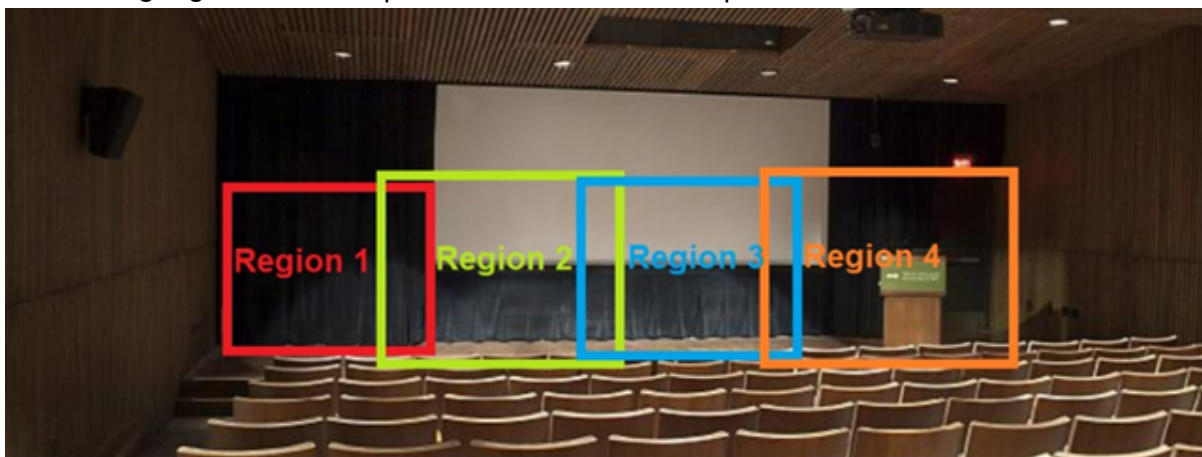



## General Configuration

To access system settings select “**Configuration**” in the top left corner of the web interface.

Menu	Explanation
Audio Configure	Includes audio compression formats, sampling frequency, sampling precision, compressing code rate settings etc.
Video Configure	Includes video encoding, video parameters, character-overlapping, character size, video output setting etc.
Network Configure	Includes Network Ports for video formats, Ethernet static or DHCP, DNS, GB28181, SRT, and RTSP
System Configure	Includes system attributes (device name/ID), system time, auto reboot scheduler, user management, firmware update, reboot, and restore factory defaults



## Audio Configure

- **Enable:** Check the Enable box to turn on embedded audio into the camera stream.
- **Encode Type:** Select the audio format (AAC only at this time).
- **Sample Rate:** 48kHz (not editable)
- **Sample Bits:** 16bit (not editable)
- **Bit Rate:** 32Kbps - 128Kbps
- **Channel:** Mono or Stereo
- **Input Volume:** Change the input volume from the source device to avoid distortion.

## Video Encode and Streaming

### Video Encode

Stream	Main Stream	Sub Stream
Compressed Format	H.264	H.264
Profile	HP	HP
Image Size	1920*1080	720*480
Rate Control	CBR	CBR
Bit Rate(Kb/s)	8192	1024
Frame Rate(F/S)	25	25
I Frame Interval	25	25
I Frame Min QP	20	20
Stream Name	live/av0	live/av1

From the Video Encode tab users can edit the following parameters for the main and sub streams:





**Compressed Format:** H.264 (default) or H.265

**Profile:** HP or MP

**Image Size:** 1280x720 - 3840x2160 (Main Stream) 320x240 - 720x480 (Sub Stream)

**Rate Control:** CBR (Constant bit rate) or VBR (Variable Bit Rate)

**Bit Rate:** Default 8192 Kb/s (recommended for 3840x2160)

**Frame Rate (F/S):** Default is 25

**I Frame Interval:** Default is 25

**I Frame Min QP:** Default is 20

**Stream Name:** Default is “live/av0” or “live/av1”

## VIDEO STREAM CAPTURE

Navigate to Configuration -> Video Encode

Stream	Main Stream	Sub Stream
Compressed Format	H.264	H.264
Profile	HP	HP
Image Size	1920*1080	720*480
Rate Control	CBR	CBR
Bit Rate(Kb/s)	8192	1024
Frame Rate(F/S)	25	25
I Frame Interval	25	25
I Frame Min QP	10	10
Stream Name	live/av0	live/av1

Configure the parameters according to your network environment.

**Note:** stream name - live/av0 (live/ XXX)



### For example:

The default IP address of the camera is 192.168.5.163. To obtain the RTSP video stream, see below:

rtsp://192.168.5.163:554/live/av0 (av0 main stream)

rtsp://192.168.5.163:554/live/av1 (av1 sub stream)

The default IP address of the camera is 192.168.5.163. To obtain the RTMP video stream, see below:

rtmp://192.168.5.163:1935/live/av0 (av0 main stream)

rtmp://192.168.5.163:1935/live/av1 (av1 sub stream)

## LIVE STREAM PUBLISH

Navigate to Configuration -> Audio Configure

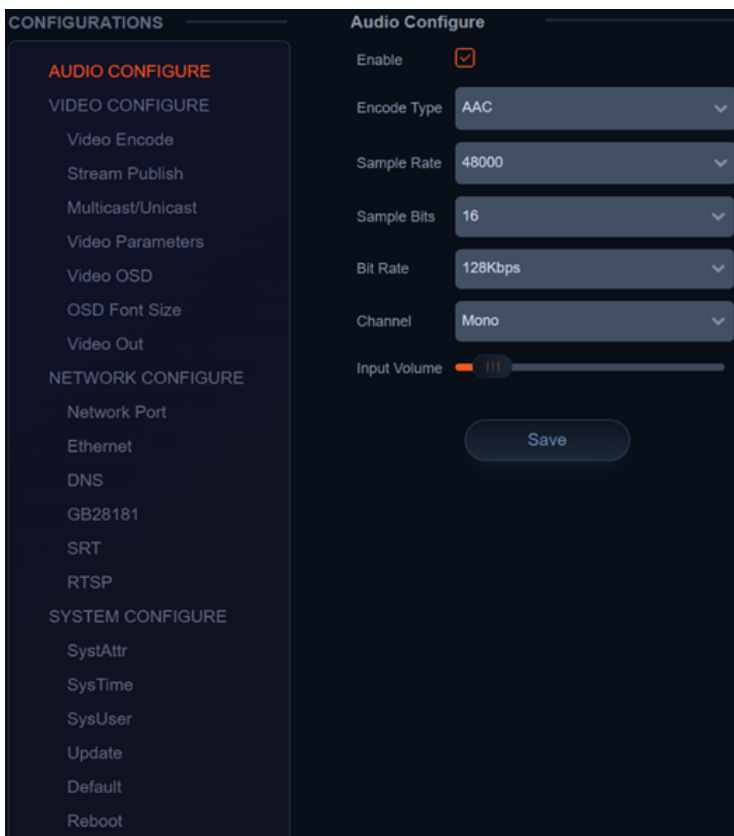

Ensure the check box next to “Enable” is toggled.

- Select AAC as the “Encode Type.”
- Change “Bit Rate” to 128Kbps to ensure the highest audio quality.
- Click Save and Reboot the camera.

**Note:** It may be necessary to adjust the “Image Size” under “Video Encode” to 1920x1080 or below to live stream due to bandwidth limitations on certain platforms.



## Navigate to Configuration -> Stream Publish

- To push an RTMP stream to a public network, such as Facebook or YouTube, the camera must be connected to a network otherwise it will fail to connect to a server.
- **Host Address:** Server address, domain name, or an IP address.
- **Host Port:** Server default port number (Facebook 443 / YouTube 1935).
- **Stream Name:** Stream key provided by streaming platform.
- **Username and Password:** Leave blank as they are set by the server.
- Click "Save"

## Multicast/Unicast

Use the Multicast / Unicast tab to control the following settings:

**Enable:** Check the box to enable or disable the Main or Sub streams

**Protocol Type:** Select the Multicast or Unicast protocol (RTP Multicast, TS Multicast, UDP Unicast, TCP Unicast)

**Address:** Set the IP address for the stream.

**Port:** Set the port for the stream

**Access Method:** Displays the full link that can be used to access the stream when enabled.



## Video Parameters

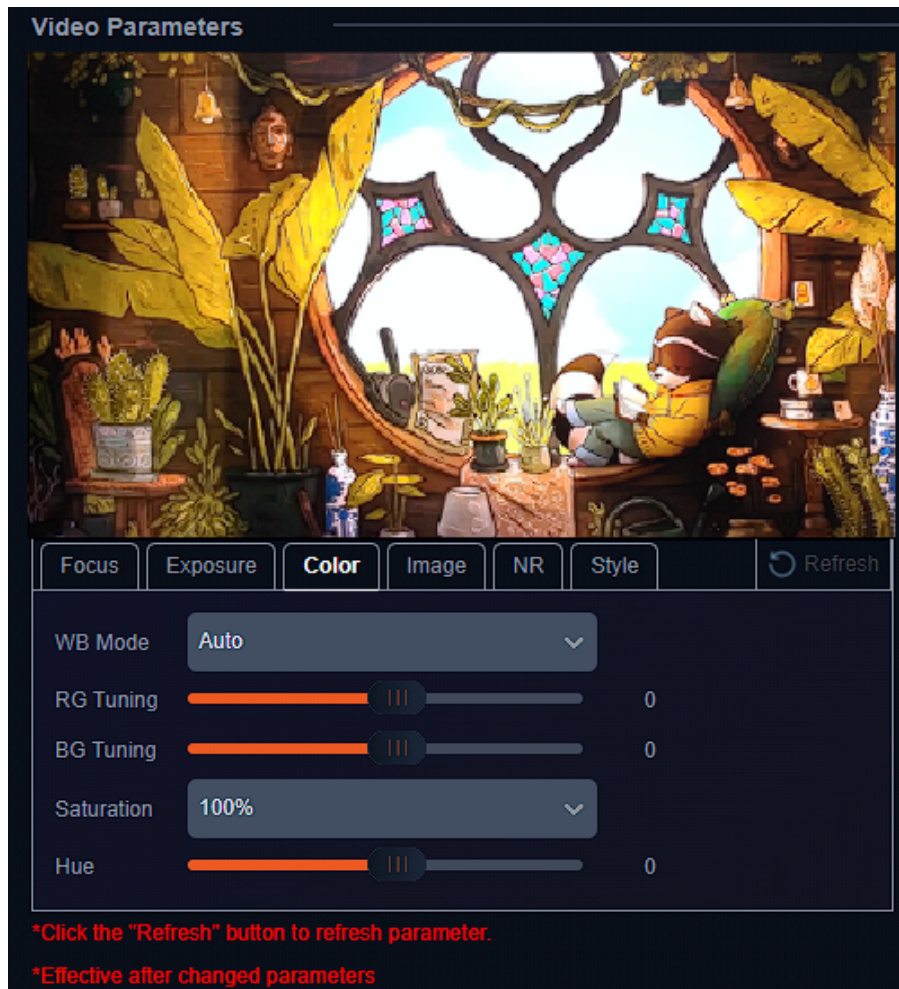

From the Video Parameters tab users have several options to manually control the image captured from the camera. Controls are broken into 6 sub sections: Focus, Exposure, Color, Image, NR, and Style. A preview image is shown above the settings so users can see their changes in real time.

### Focus



**Focus Mode:** Auto, Manual, OnePush

**AF-Zone:** Top, Center, Bottom, or All tells the camera which area of the shot is the primary point of focus.

**AF-Sensitivity:** Low, Middle, High changes how often the

camera attempts to refocus when the mode is set to Auto.



## Exposure

Depending on the Exposure mode selected different control options will be displayed as shown below:

### Auto

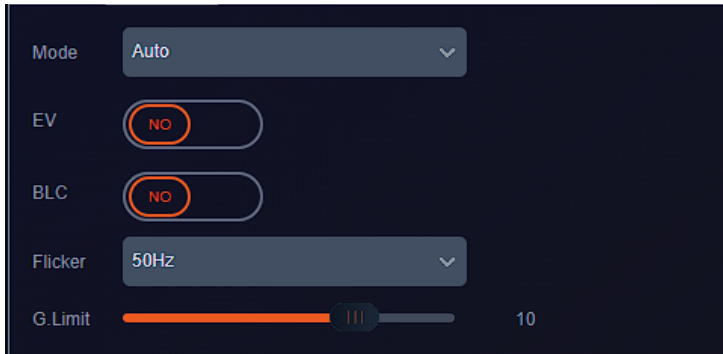

### Manual

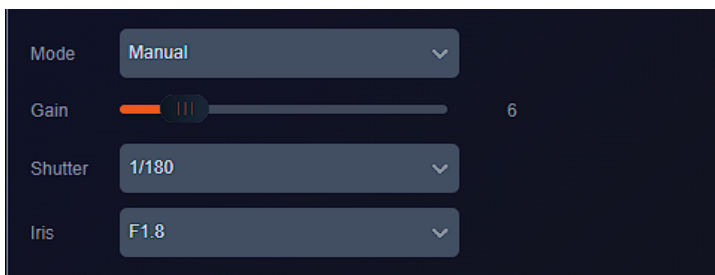

### SAE

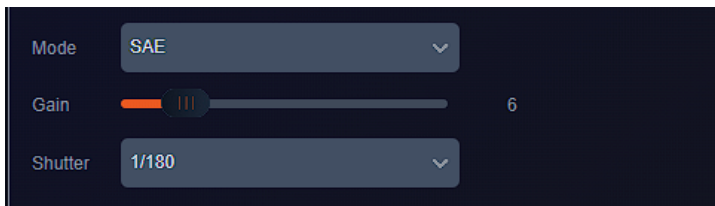

### AAE

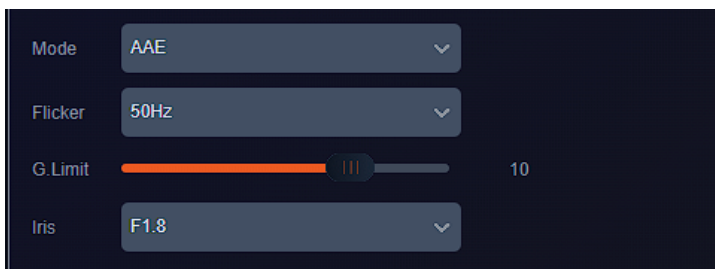

### Bright

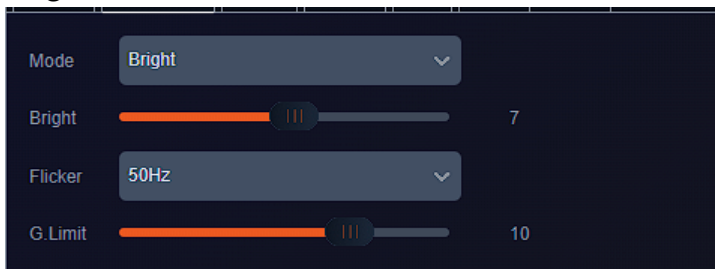



## Color

By default the WB Mode (White Balance) is set to Auto. Color temperatures from 2400K - 7100K, Manual, or OnePush are selectable. Options will change depending on the mode selected as shown below:

### Auto and Manual

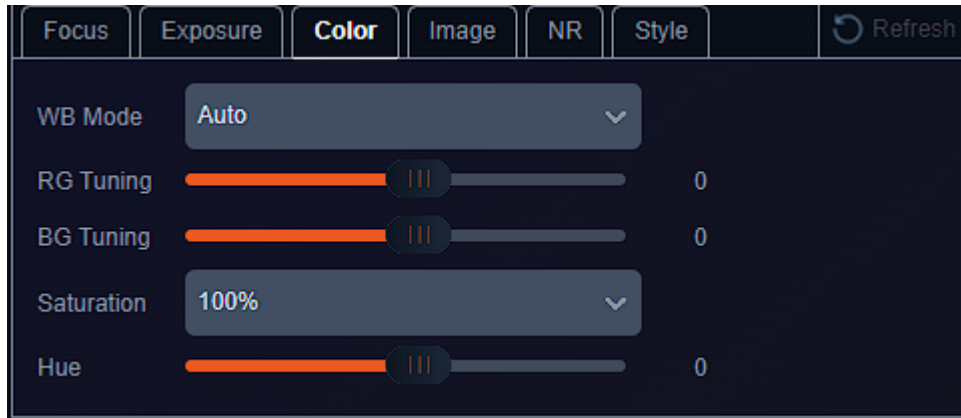

### Color Temperature 2400K - 7100K

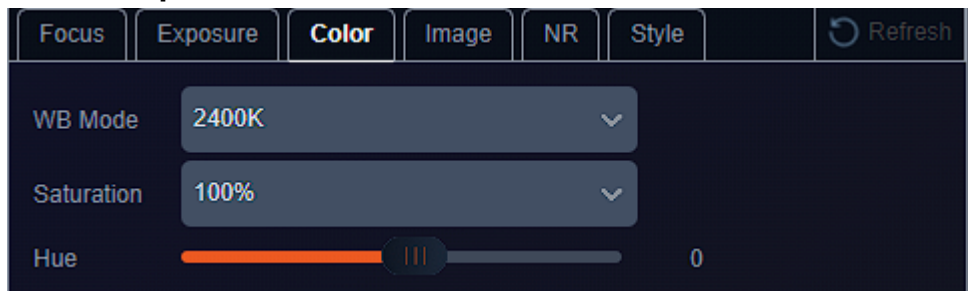

### OnePush

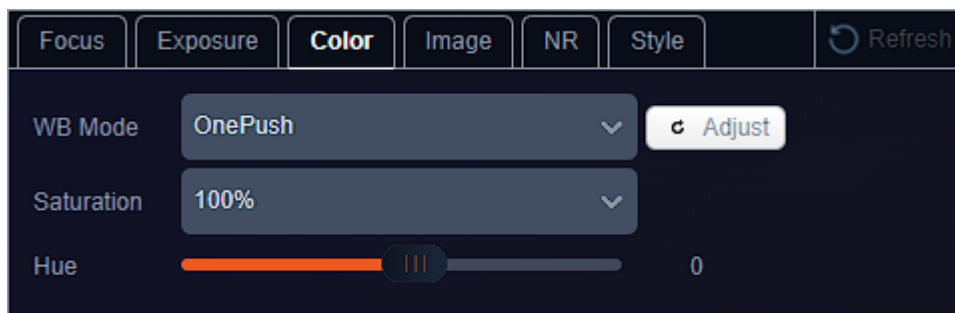

Press the “Adjust” button to lock in new white balance settings. This setting is useful when a white balance card is used.



## Image

From the Image tab users can control settings such as image Brightness, Contrast, Sharpness, B&W Mode (Black and white), Flip-H, Flip-V, Auto Flip, DZoom (digital zoom).

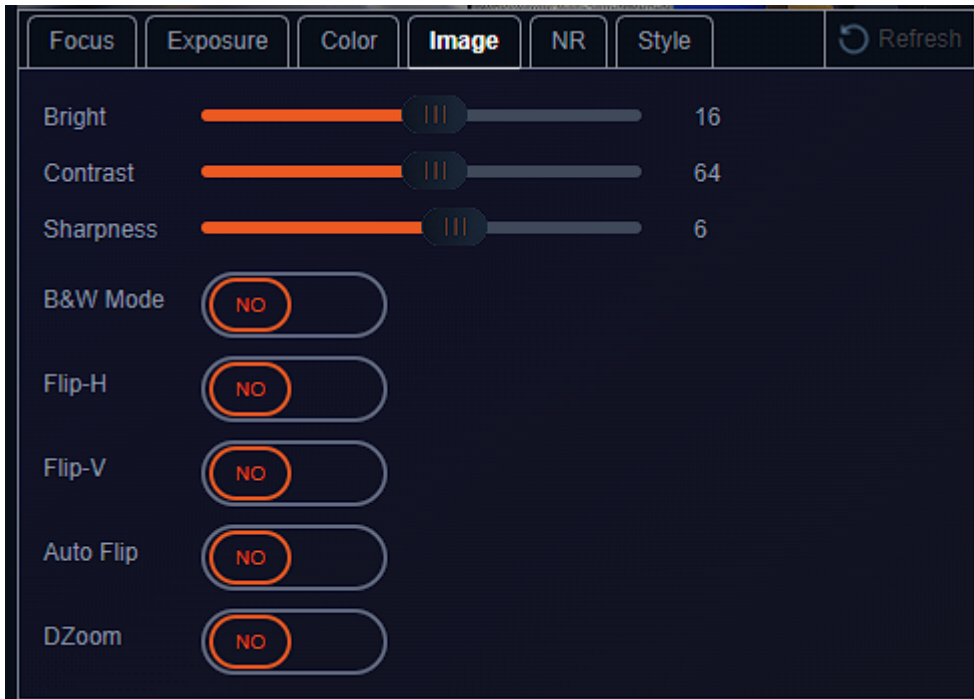

**Note:** Flip-H and Flip-V are only available when Auto Flip is disabled. DZoom allows the camera to digitally zoom in on a shot past the standard optical zoom range but may reduce image quality.

## NR

The NR-3D setting are intended to aid in reducing “noise” in an image caused by lighting.

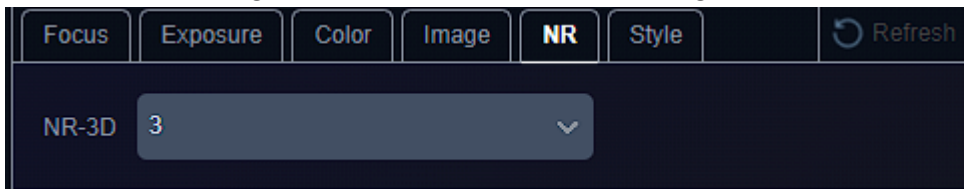

## Style

Style is used to select a preset configuration of camera parameters. Options include: Default, Meeting, Clarity, Bright, and Soft.

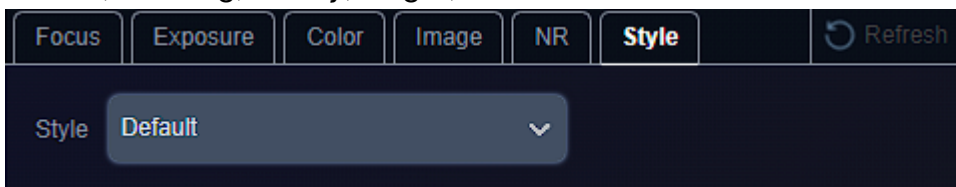



## Video OSD and OSD Font

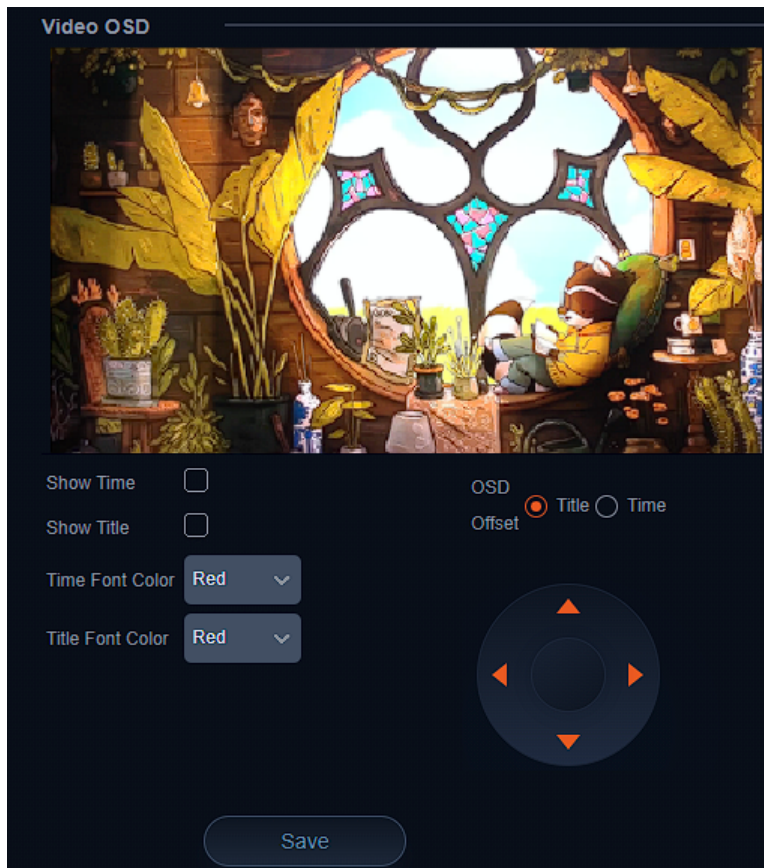

Video OSD or On Screen Display gives users the option to display the Device Name, Date, and Time, on the stream of the camera. This can be useful in easily identifying cameras when multiple are in use simultaneously in a production or security type setup.

Font colors and text locations can be edited using the drop downs and control options. Time and Title will appear once the options are enabled and saved.

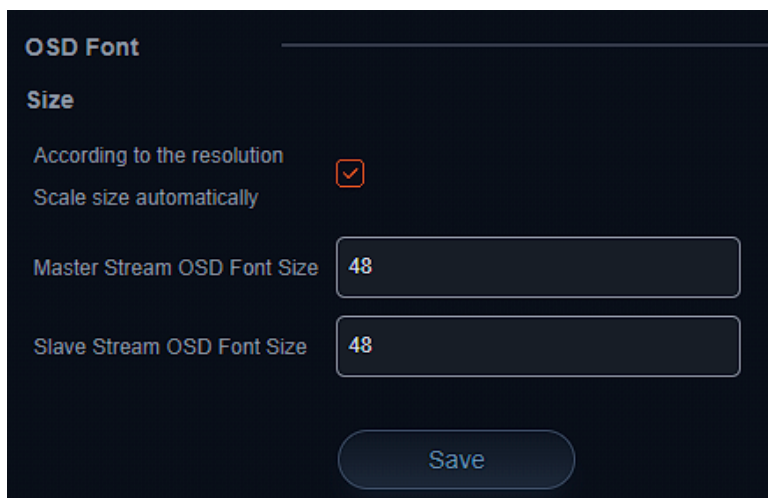

OSD Font is used to adjust the size of the OSD text.





## Video Out

---

Video Out

Video Out Format 1080P60

Save

Video Out is used to adjust output resolution of the camera to its physical HDMI and SDI outputs.

**Note:** To adjust NDI, Dante, RTSP stream, USB, and SD Capture resolutions, use the Video Encode Main or Sub stream setting “Image Size.”

## Network Configure

---

### Network Port

---

Network Port

Port Data 3000

Port Web 80

Port Onvif 2000

Port Soap 1936

Port RTMP 1935

Port Rtsps 554

Port Visca 1259

Port Https 443

Port WebSocket 8088

Save

Network Port allows users to modify port settings for various camera streams. The port follows the IP address but before stream specific information when connecting to various stream types.

**Example:** `rtsp://192.168.5.163:554/live/av0`  
:554 is the port

Depending on your network configuration some ports may be blocked, unavailable, or unreachable. It may be necessary to contact your network administrator to resolve these types of issues.



## Ethernet

Ethernet settings allow users to change or modify how the camera is accessed on the network.

### DHCP

If the DHCP box is enabled, the local network will automatically assign an IP address to the camera the next time it is rebooted. This feature can also be enabled using the remote by pressing \* + \* + 1 or disabled by pressing \* + \* + 2.

The current IP address of the camera is displayed on start up when

connected to an external display via HDMI or SDI. It can also be displayed using the remote by pressing \* + \* + 3.

**NOTE:** It is highly recommended to turn DHCP off once an IP address is obtained from the network so the camera remains at a static, predictable, IP address for use with PTZ controllers, apps, and other devices.

## DNS

Allows users to change the Preferred and Alternate DNS server settings of the camera to a specific DNS server of their choice if required by their network.



## GB28181, SRT, and RTSP Authentication

**GB28181** is a camera protocol similar to ONVIF but uses Session Initiation Protocol (SIP).

These settings are typically used by particularly government entities and can be largely ignored by the standard user.

**SRT** is an alternative to standard RTSP streams. SRT can recover from packet loss of up to 15%. This provides a better video stream on substandard or congested networks. It also helps keep streams secure and easily traverses firewalls.

**RTSP Authentication** when enabled required users to enter the camera's login credentials directly into the RTSP stream URL to gain access as shown:  
rtsp://USER:PASS@[IP]:port/stream info.

**Default settings example:**

rtsp://admin:admin@192.168.5.163:554/live/av0



## System Configure

### System Attribute, System Time, & System User

**SYSTEM ATTRIBUTE**

Device Name: CAMERA-1

Device ID: 1

Language: English

Save

**System Attribute** allows users to edit the Device Name of the camera which can be helpful when identifying devices through enterprise level networks.

**System Time**

Date Format: YYYY-MM-DD

Date Separator: /

Zone: (GMT+08:00)Beijing, Hongkong, Sing

Hour Type: 24 Hours

NTP Enable:

Update Interval: 1 day

Host Url: time.nist.gov

Host Port: 123

Save

**Time Settings**

Time Settings: Synchronize with computer time

Computer Time: 2023-11-06 17:17:51

Sync.

**System Time** allows users to edit date and hour formats, time zones, hour type (24hr/12hr), if an NTP server is used or if the camera syncs to the connected computer via the web interface.

Camera time should be synchronized prior to using Auto Reboot to ensure accuracy.

**System User** allows Admin level users to edit usernames and passwords for up to 3 different users and set their authority level. Standard Users do not have access to any configuration settings. Admins have full control over the camera.



## Auto Reboot

Auto Reboot allows users to schedule the camera to automatically reboot on a certain time daily, once per week, or once per month. This is useful when the camera remains on constantly and helps to alleviate random system problems that may occur over time,

The screenshot displays the 'Auto Reboot' configuration interface with three distinct settings sections:

- Section 1:** The 'Auto Reboot' toggle is turned off. The 'Schedule' is set to 'Daily' (selected with a radio button). The 'Time' is set to '12:00 AM' via a dropdown menu. A 'Save' button is located below these options.
- Section 2:** The 'Auto Reboot' toggle is turned off. The 'Schedule' is set to 'Weekly' (selected with a radio button). The 'Repeat On' days are 'M', 'T', 'W', 'T', 'F', 'S', and 'S', with 'M' highlighted in orange. The 'Time' is set to '12:00 AM' via a dropdown menu.
- Section 3:** The 'Auto Reboot' toggle is turned off. The 'Schedule' is set to 'Monthly' (selected with a radio button). The 'On Date' is set to '1' and the 'Time' is set to '12:00 AM', both via dropdown menus.



## Operation System

---

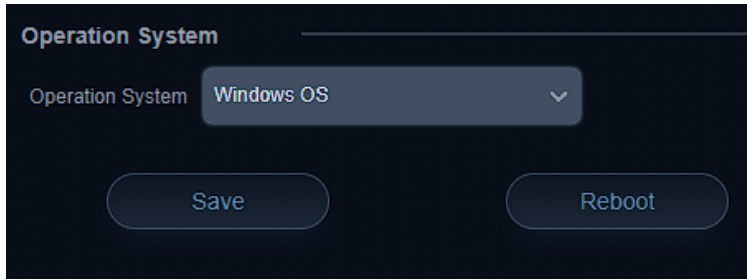

**Operation System** is used to control and limit the USB output resolution and refresh rate when connecting to Windows OS or MAC OS platforms to ensure the best possible performance.

## Update, Default, & Reboot

---

**Update** shows the camera's current firmware information and also allows users to upload new firmware to the camera.

**Default** is used to restore the camera to its factory default settings. This includes all network settings, image parameters, presets, etc.

**Reboot** is used to power cycle the camera via the web interface without having to unplug any cables or use the physical power switch on the back of the device.



## Dante

Dante stands for digital audio network through ethernet. Dante AV-H by Audinate is one of the leading network based production standards in the AV over IP space. Dante AV-H technology will enable users to stream their camera footage over a local area network with a single ethernet cable. Dante AV-H uses H.26x compression to compress the bandwidth of a camera's video feed to allow it to stream over a local area network with near zero latency.

To use a Dante enabled camera, a computer running Dante Controller and Dante Studio software must be on the same network. For instructions on networking the camera or modifying your computer settings see the “Network Connection” section of this manual.

After installing Dante Controller and Dante Studio on your computer follow the instructions below:

- 1) Open the Dante Studio Software and click the “Licensing” tab and enter your product license (not provided).

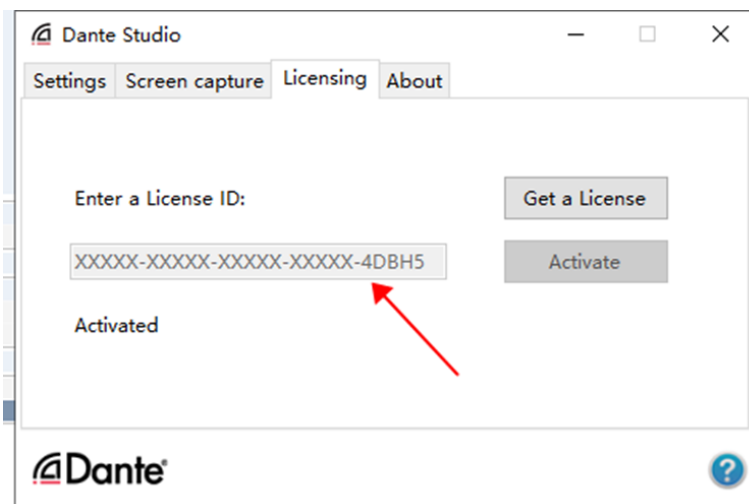

- 2) Click the “Settings” tab and if “Dante Studio: Running” is shown proceed to the next step.

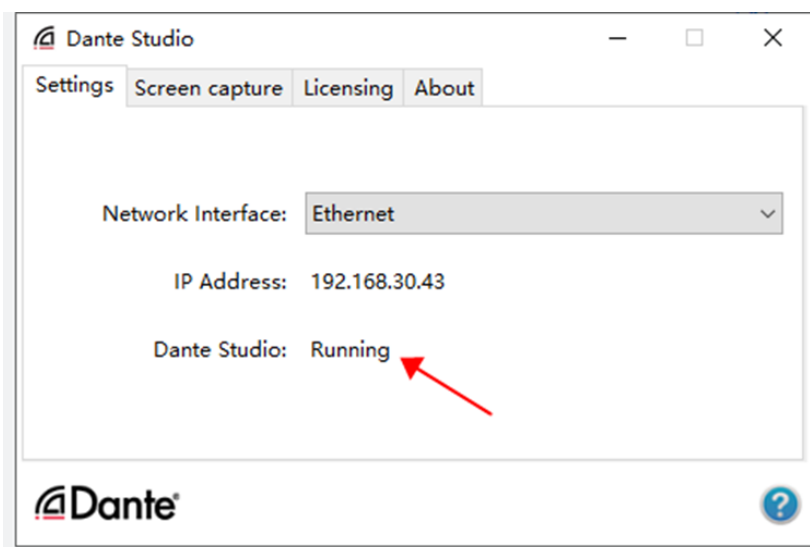



3) Open the Dante Controller software and click the “Choose a Dante Interface” button.

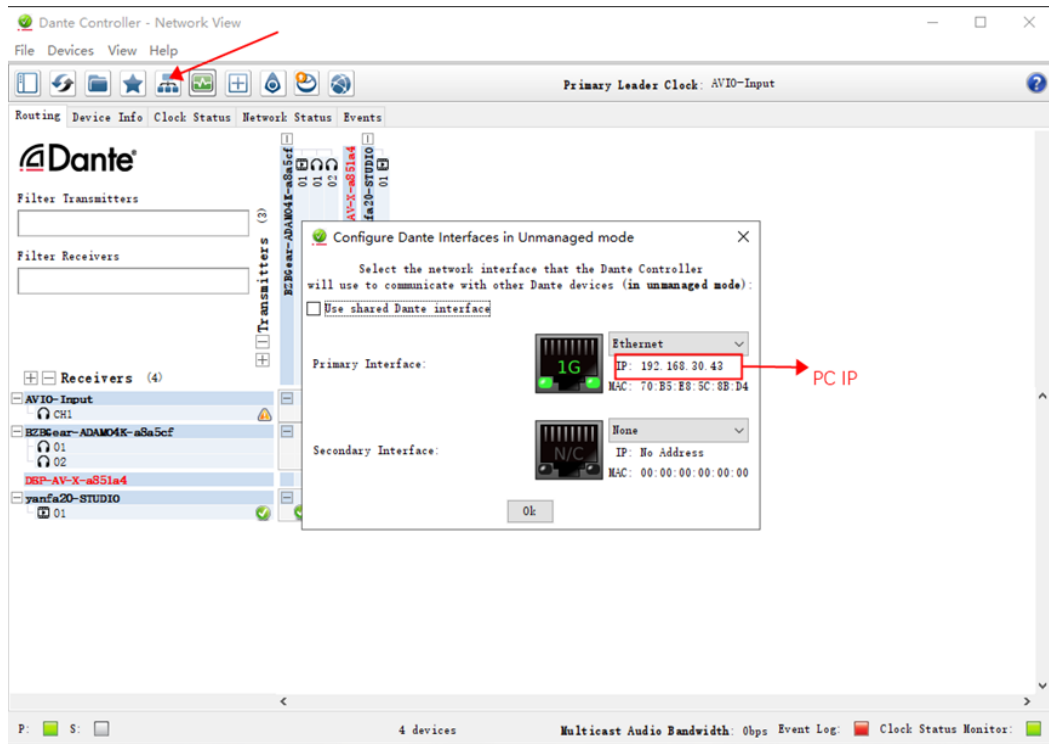

a) Ensure your correct PC network interface is selected and that the listed IP is in the same subnet as the camera. (**Note:** Your computer cannot have multiple subnets enabled unless your camera is on the lowest numerical subnet as that is what the Dante Control software will see.)

4) Select the “Device Info” tab to view available Dante devices.

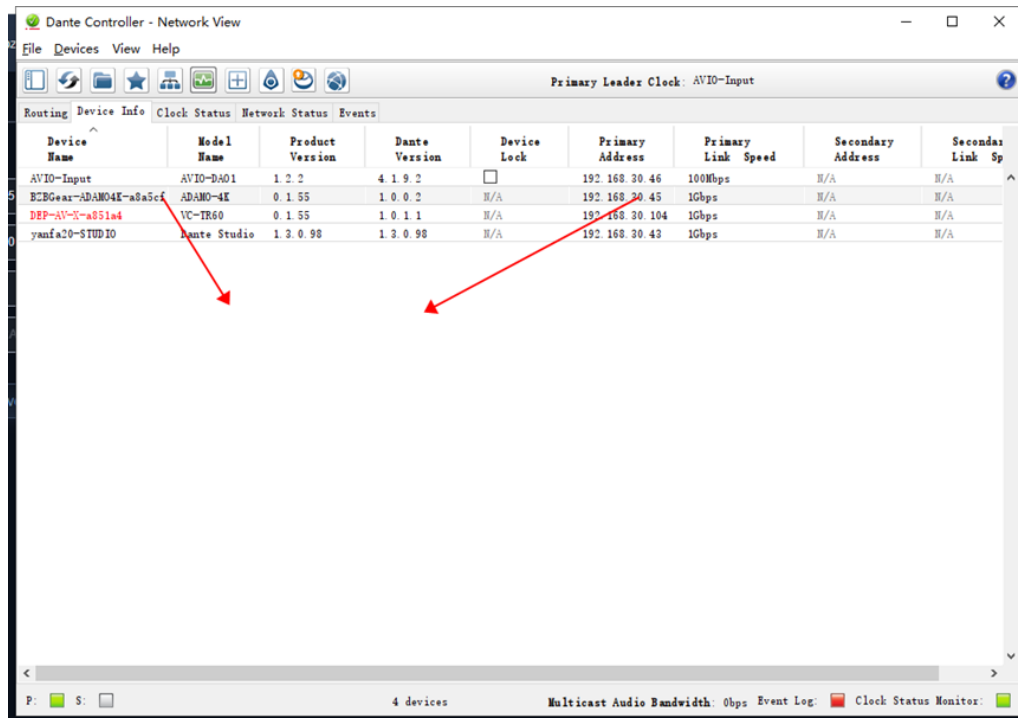

a) Ensure the IP address of the camera you wish to view is shown correctly.





- 5) Click the “Routing” tab to return to the main screen. The vertical axis displays transmitters in this case cameras. The Horizontal axis displays Dante receivers such as the computer running Dante Studio.
  - a) To enable a Dante stream, select to expand a transmitter by clicking the + icon and then expand the desired receiver (typically your computer).
  - b) Check the box where the transmitter and receiver intersect as shown in the image below

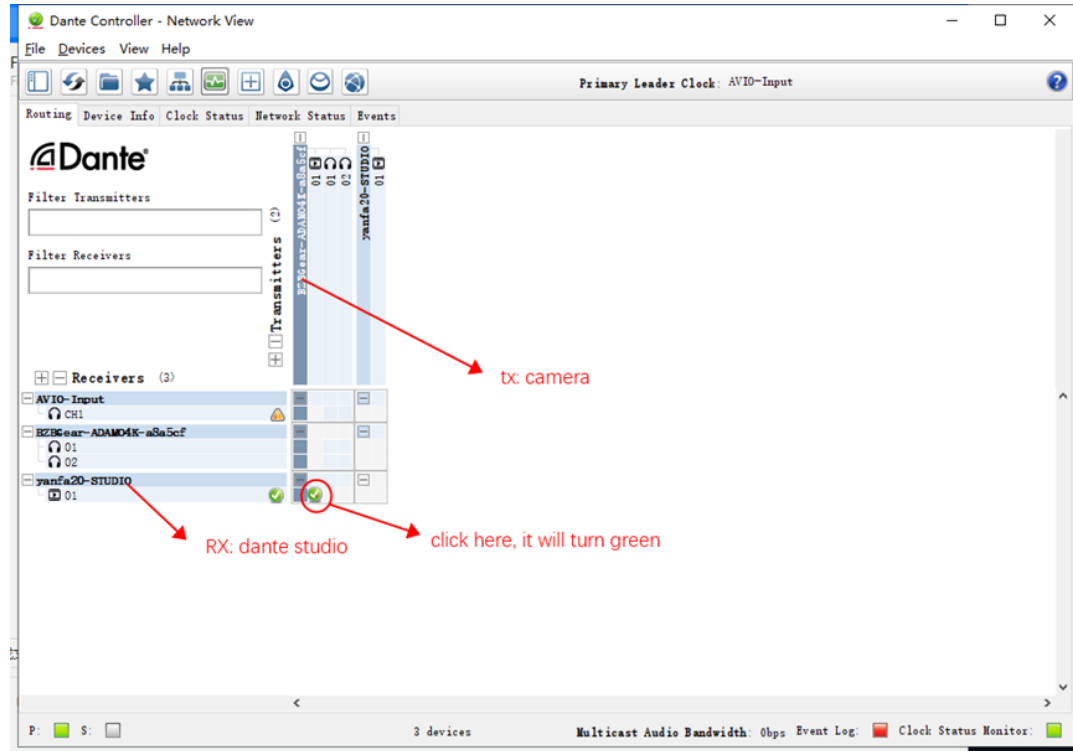

- 6) Open Dante Video Viewer or OBS Studio to view the live stream
 

**Note:** If your receiving device is not listed or your version of Dante Studio appears different than above you may need to change your receiver's “Decoder” to H.264/AVC to view the video stream.

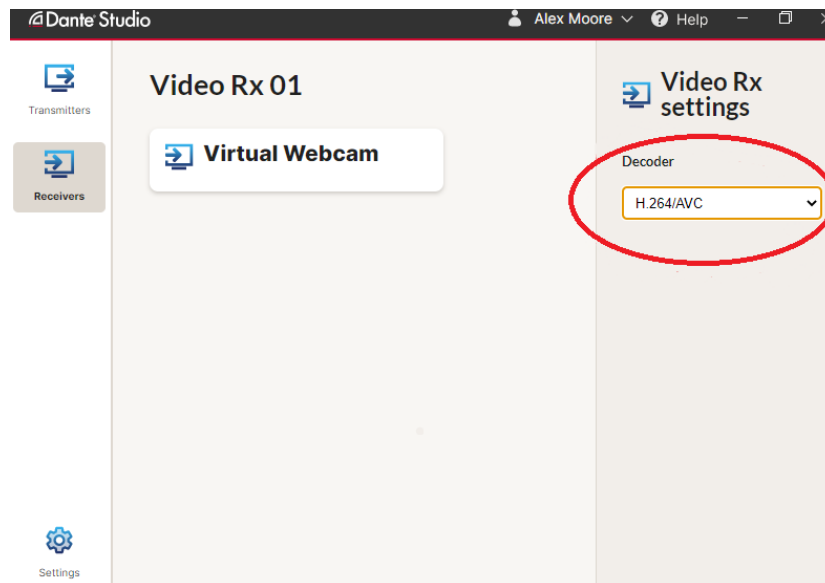



## Serial Port Communication and Control

The camera can be controlled through an RS232/RS485 interface. RS232C serial parameters are as follows: Baud rate: 2400/4800/9600/115200 bits / sec; Start bit: 1; data bits: 8; Stop bit: 1; Parity: None

## VISCA Protocol List

### VISCA PROTOCOL RETURN COMMAND

Ack/Completion Message		
	Command packet	Note
ACK	z0 41 FF	Returned when the command is accepted.
Completion	z0 51 FF	Returned when the command has been executed.

z= camera address + 8

Error Messages		
	Command packet	Note
Syntax Error	z0 60 02 FF	Returned when the command format is different or when a command with illegal command parameters is accepted
Command Not Executable	z0 61 41 FF	Returned when a command cannot be executed due to current conditions. For example, when commands controlling the focus manually are received during auto focus.

### VISCA PROTOCOL CONTROL COMMANDS

Command	Function	Command packet	Note
AddressSet	Broadcast	88 30 0p FF	p: Address setting
IF_Clear	Broadcast	88 01 00 01 FF	I/F Clear
CommandCancel		8x 21 FF	
CAM_Power	On	8x 01 04 00 02 FF	Power ON/OFF
	Off	8x 01 04 00 03 FF	
CAM_Zoom	Stop	8x 01 04 07 00 FF	
	Tele(Standard)	8x 01 04 07 02 FF	
	Wide(Standard)	8x 01 04 07 03 FF	
	Tele(Variable)	8x 01 04 07 2p FF	
	Wide(Variable)	8x 01 04 07 3p FF	
	Direct	8x 01 04 47 0p 0q 0r 0s FF	p = 0(low) - F(high)



Command	Function	Command packet	Note	
CAM_Focus	Stop	8x 01 04 07 00 FF		
	Far(Standard)	8x 01 04 08 00 FF		
	Near(Standard)	8x 01 04 08 02 FF		
		Far(Variable)	8x 01 04 08 03 FF	p = 0(low) - F(high)
		Near (Variable)	8x 01 04 08 2p FF	
		Direct	8x 01 04 08 3p FF	pqrs: Focus Position
		Auto Focus	8x 01 04 48 0p 0q 0r 0s FF	
		Manual Focus	8x 01 04 38 03 FF	
		One Push mode	8x 01 04 38 04 FF	
CAM_Zoom Focus	Direct	8x 01 04 47 0p 0q 0r 0s 0t 0u 0v 0w FF	pqrs: Zoom Position tuvw: Focus Position	
CAM_WB	Auto	8x 01 04 35 00 FF		
	3000K	8x 01 04 35 01 FF		
	4000k	8x 01 04 35 02 FF		
	One Push mode	8x 01 04 35 03 FF		
	5000k	8x 01 04 35 04 FF		
CAM_WB (cont.)	Manual	8x 01 04 35 05 FF		
	6500k	8x 01 04 35 06 FF		
	3500K	8x 01 04 35 07 FF		
	4500K	8x 01 04 35 08 FF		
	5500K	8x 01 04 35 09 FF		
	6000K	8x 01 04 35 0A FF		
	7000K	8x 01 04 35 0B FF		

Command	Function	Command packet	Note
CAM_RGain	Reset	8x 01 04 03 00 FF	Manual Control of R Gain
	Up	8x 01 04 03 02 FF	
	Down	8x 01 04 03 03 FF	
	Direct	8x 01 04 43 00 00 0p 0q FF	pq: R Gain
CAM_Bgain	Reset	8x 01 04 04 00 FF	Manual Control of B Gain
	Up	8x 01 04 04 02 FF	
	Down	8x 01 04 04 03 FF	
	Direct	8x 01 04 44 00 00 0p 0q FF	pq: B Gain
CAM_AE	Full Auto	8x 01 04 39 00 FF	Automatic Exposure mode
	Manual	8x 01 04 39 03 FF	Manual Control mode
	Shutter priority	8x 01 04 39 0A FF	Shutter Priority Automatic Exposure mode
	Iris priority	8x 01 04 39 0B FF	Iris Priority Automatic Exposure mode



Command	Function	Command packet	Note
	Bright	8x 01 04 39 0D FF	Bright mode
	Full Auto	8x 01 04 39 00 FF	Automatic Exposure mode
CAM_Shutter	Reset	8x 01 04 0A 00 FF	Shutter Setting
	Up	8x 01 04 0A 02 FF	
	Down	8x 01 04 0A 03 FF	
	Direct	8x 01 04 4A 00 00 0p 0q FF	pq: Shutter Position
CAM_Iris	Reset	8x 01 04 0B 00 FF	Iris Setting
	Up	8x 01 04 0B 02 FF	
	Down	8x 01 04 0B 03 FF	
	Direct	8x 01 04 4B 00 00 0p 0q FF	pq: Iris Position
CAM_Gain Limit	Gain Limit	8x 01 04 2C 0p FF	p: Gain Position
	Reset	8x 01 04 0D 00 FF	
CAM_Bright	Up	8x 01 04 0D 02 FF	
	Down	8x 01 04 0D 03 FF	Bright Setting
	Direct	8x 01 04 4D 00 00 0p 0q FF	pq: Bright Position
CAM_ExpComp	On	8x 01 04 3E 02 FF	Exposure Compensation ON/OFF
	Off	8x 01 04 3E 03 FF	
	Reset	8x 01 04 0E 00 FF	Exposure Compensation Amount Setting
	Up	8x 01 04 0E 02 FF	
CAM_ExpComp	Down	8x 01 04 0E 03 FF	
	Direct	8x 01 04 4E 00 00 0p 0q FF	pq: ExpComp Position
CAM_Back Light	On	8x 01 04 33 02 FF	Back Light Compensation
	Off	8x 01 04 33 03 FF	
CAM_WDRStrength	Reset	8x 01 04 21 00 FF	WDR Level Setting
	Up	8x 01 04 21 02 FF	
	Down	8x 01 04 21 03 FF	

Command	Function	Command packet	Note
CAM_WDRStrength (cont.)	Direct	8x 01 04 51 00 00 00 0p FF	p: WDR Level Position
CAM_NR(2D)		8x 01 04 53 0p FF	P=0-7 0:OFF
CAM_NR(3D)		8x 01 04 54 0p FF	P=0-8 0:OFF
CAM_Gamma		8x 01 04 5B 0p FF	p = 0 – 40: Default 1:0.45 2:0.50 3:0.55 4:0.63
CAM_Flicker	OFF	8x 01 04 23 00 FF	OFF
	50HZ	8x 01 04 23 01 FF	50HZ
	60HZ	8x 01 04 23 02 FF	60HZ
CAM_Aperture	Reset	8x 01 04 02 00 FF	Aperture Control
	Up	8x 01 04 02 02 FF	
	Down	8x 01 04 02 03 FF	



Command	Function	Command packet	Note
	Direct	8x 01 04 42 00 00 0p 0q FF	pq: Aperture Gain
CAM_Memory	Reset	8x 01 04 3F 00 pq FF	pq: Memory Number(=0 to 254) Corresponds to 0 to 9 on the Remote Commander
	Set	8x 01 04 3F 01 pq FF	
	Recall	8x 01 04 3F 02 pq FF	
CAM_LR_Reverse	On	8x 01 04 61 02 FF	Image Flip Horizontal ON/OFF
	Off	8x 01 04 61 03 FF	
CAM_PictureFlip	On	8x 01 04 66 02 FF	Image Flip Vertical ON/OFF
	Off	8x 01 04 66 03 FF	
CAM_ColorSaturation	Direct	8x 01 04 49 00 00 00 0p FF	P=0-E 0:60% 1:70% 2:80% 3:90% 4:100% 5:110% 6:120% 7:130% 8:140% 9:150% 10:160% 11:160% 12:180% 13:190% 14:200%
CAM_IDWrite		8x 01 04 22 0p 0q 0r 0s FF	pqrs: Camera ID (=0000 to FFFF)
SYS_Menu	ON	8x 01 04 06 06 02 FF	Turn on the menu screen
	OFF	8x 01 04 06 06 03 FF	Turn off the menu screen
IR_Receive	ON	8x 01 06 08 02 FF	IR(remote commander)receive On/Off
	OFF	8x 01 06 08 03 FF	
IR_ReceiveReturn	On	8x 01 7D 01 03 00 00 FF	IR(remote commander)receive message via
	Off	8x 01 7D 01 13 00 00 FF	
IR_ReceiveReturn	Reset	8x 01 04 A0 10 FF	Reset Factory Setting
CAM_Brightness	Direct	8x 01 04 A1 00 00 0p 0q FF	pq: Brightness Position
CAM_Contrast	Direct	8x 01 04 A2 00 00 0p 0q FF	pq: Contrast Position
CAM_Flip	OFF	8x 01 04 A4 00 FF	Single Command For Video Flip
	Flip-H	8x 01 04 A4 01 FF	
	Flip-V	8x 01 04 A4 02 FF	
	Flip-HV	8x 01 04 A4 03 FF	

Command	Function	Command packet	Note
CAM_VideoSystem	Set camera video system	8x 01 06 35 00 0p FF	P: 0~E Video format 0:1080P60 8:720P30 1:1080P50 9:720P25 2:1080i60 A: 1080P59.94 3:1080i50 B: 1080i59.94 4:720P60 C: 720P59.94 5:720P50 D: 1080P29.97 6:1080P30 E: 720P29.97 7:1080P25
Pan_tiltDrive	Up	8x 01 06 01 VV WW 03 01 FF	VV: Pan speed 0x01 (low speed) to 0x18 (high speed) WW: Tilt speed 0x01 (low speed) to 0x14 (high speed) YYYY: Pan Position ZZZZ: Tilt Position
	Down	8x 01 06 01 VV WW 03 02 FF	
	Left	8x 01 06 01 VV WW 01 03 FF	
	Right	8x 01 06 01 VV WW 02 03 FF	



Command	Function	Command packet	Note
	Upleft	8x 01 06 01 VV WW 01 01 FF	
	Upright	8x 01 06 01 VV WW 02 01 FF	
	DownLeft	8x 01 06 01 VV WW 01 02 FF	
	DownRight	8x 01 06 01 VV WW 02 02 FF	
	Stop	8x 01 06 01 VV WW 03 03 FF	
	AbsolutePosition	8x 01 06 02 VV WW 0Y 0Y 0Y 0Y 0Z 0Z 0Z 0Z FF	
	RelativePosition	8x 01 06 03 VV WW 0Y 0Y 0Y 0Y 0Z 0Z 0Z 0Z FF	
	Home	8x 01 06 04 FF	
	Reset	8x 01 06 04 FF	
Pan-tiltLimitSet	Set	8x 01 06 07 00 0W 0Y 0Y 0Y 0Y 0Z 0Z 0Z 0Z FF	8x 01 06 07 01 0W 07 0F 0F 0F 07 0F 0F 0F FF
	Clear	8x 01 06 07 01 0W 07 0F 0F 0F 07 0F 0F 0F FF	

Command	Function	Command packet	Note
Red On	Tally Light On	81 01 7E 01 0A 00 02 00 FF	Red Tally Light On
Red Off	Tally Light Off	81 01 7E 01 0A 00 03 00 FF	Red Tally Light Off
Green On	Tally Light On	81 01 7E 01 0A 00 00 02 FF	Green Tally Light On
Green Off	Tally Light Off	81 01 7E 01 0A 00 00 03 FF	Green Tally Light Off
Auto Tracking On	Auto Tracking Mode On	8x 0A 01 32 00 00 02 00 FF	Tracking Mode On
Auto Tracking Off	Auto Tracking Mode Off	8x 0A 01 32 00 00 03 00 FF	Tracking Mode Off

**VISCA PROTOCOL INQUIRY COMMANDS**

Command	Command Packet	Return Packet	Note
CAM_PowerInq	8x 09 04 00 FF	y0 50 02 FF	On
		y0 50 03 FF	Off(Standby)
CAM_ZoomPosInq	8x 09 04 47 FF	y0 50 0p 0q 0r 0s FF	pqrs: Zoom Position
CAM_FocusAFModelInq	8x 09 04 38 FF	y0 50 02 FF	Auto Focus
		y0 50 03 FF	Manual Focus
		y0 50 04 FF	One Push mode
CAM_FocusPosInq	8x 09 04 48 FF	y0 50 0p 0q 0r 0s FF	pqrs: Focus Position
CAM_WBModelInq	8x 09 04 35 FF	y0 50 00 FF	Auto
		y0 50 01 FF	3000K
		y0 50 02 FF	4000K
		y0 50 03 FF	One Push Mode
		y0 50 04 FF	5000K



Command	Command Packet	Return Packet	Note
		y0 50 05 FF	Manual
		y0 50 00 FF	6500K
		y0 50 06 FF	6500K
		y0 50 07 FF	3500K
		y0 50 08 FF	4500K
		y0 50 09 FF	5500K
		y0 50 0A FF	6000K
CAM_RGainInq	8x 09 04 43 FF	y0 50 0B FF	7000K
CAM_BGainInq	8x 09 04 44 FF	y0 50 00 00 0p 0q FF	pq: B Gain
CAM_AEModeInq	8x 09 04 39 FF	y0 50 00 FF	Full Auto
		y0 50 03 FF	Manual
		y0 50 0A FF	Shutter priority
		y0 50 0B FF	Iris priority
CAM_ShutterPosInq	8x 09 04 4A FF	y0 50 00 00 0p 0q FF	pq: Shutter Position
CAM_IrisPosInq	8x 09 04 4B FF	y0 50 00 00 0p 0q FF	pq: Iris Position
CAM_Gain LimitInq	8x 09 04 2C FF	y0 50 0p FF	p: Gain Position
CAM_BrightPosInq	8x 09 04 4D FF	y0 50 00 00 0p 0q FF	pq: Bright Position
CAM_ExpCompModeInq	8x 09 04 3E FF	y0 50 02 FF	On
		y0 50 03 FF	Off
CAM_ExpCompPosInq	8x 09 04 4E FF	y0 50 00 00 0p 0q FF	pq: ExpComp Position
CAM_BacklightModeInq	8x 09 04 33 FF	y0 50 02 FF	On
		y0 50 03 FF	Off
CAM_WDRStrengthInq	8x 09 04 51 FF	y0 50 00 00 00 0p FF	p: WDR Strength
CAM_NRLevel(2D) Inq	8x 09 04 53 FF	y0 50 0p FF	P: 2DNRLLevel
CAM_NRLevel(3D) Inq	8x 09 04 54 FF	y0 50 0p FF	P:3D NRLevel
CAM_FlickerModeInq	8x 09 04 55 FF	y0 50 0p FF	p: Flicker Settings(0: OFF, 1: 50Hz, 2:60Hz)
CAM_ApertureInq	8x 09 04 42 FF	y0 50 00 00 0p 0q FF	pq: Aperture Gain
CAM_PictureEffectModeInq	8x 09 04 63 FF	y0 50 00 FF	Off
		y0 50 04 FF	B&W
CAM_MemoryInq	8x 09 04 3F FF	y0 50 0p FF	p: Memory number last operated.



Command	Command Packet	Return Packet	Note
SYS_MenuModelInq	8x 09 06 06 FF	y0 50 02 FF	On
		y0 50 03 FF	Off
CAM_LR_ReverseInq	8x 09 04 61 FF	y0 50 02 FF	On
		y0 50 03 FF	Off
CAM_PictureFlipInq	8x 09 04 66 FF	y0 50 02 FF	On
		y0 50 03 FF	Off
CAM_ColorSaturationInq	8x 09 04 49 FF	y0 50 00 00 00 0p FF	p: Color Gain setting 0h (60%) to Eh (130%)
CAM_IDInq	8x 09 04 22 FF	y0 50 0p FF	p: Gamma ID
IR_ReceiveInq	8x 09 06 08 FF	y0 50 02 FF	On
		y0 50 03 FF	Off
IR_ReceiveReturn		y0 07 7D 01 04 00 FF	Power ON/OFF
		y0 07 7D 01 04 07 FF	Zoom tele/wide
		y0 07 7D 01 04 38 FF	AF ON/OFF
		y0 07 7D 01 04 33 FF	Camera _Backlight
		y0 07 7D 01 04 3F FF	Camera _Memery
		y0 07 7D 01 06 01 FF	Pan_titleDriver
CAM_BrightnessInq	8x 09 04 A1 FF	y0 50 00 00 0p 0q FF	pq: Brightness Position
CAM_ContrastInq	8x 09 04 A2 FF	y0 50 00 00 0p 0q FF	pq: Contrast Position
CAM_FlipInq	8x 09 04 A4 FF	y0 50 00 FF	Off
		y0 50 01 FF	Flip-H
		y0 50 02 FF	Flip-V
		y0 50 03 FF	Flip-HV
CAM_GammaInq	8x 09 04 5B FF	y0 50 0p FF	p: Gamma setting
CAM_VersionInq	8x 09 00 02 FF	y0 50 ab cd mn pq rs tu vw FF	ab cd : vender ID ( 0220 ) mn pq : model ID ST ( 0510 ) 、 U2( 0512 )、 U3 ( 0513 ) rs tu : ARM Version vw : reserve
VideoSystemInq	8x 09 06 23 FF	y0 50 0p FF	P: 0~E Video format 0:1080P60 8:720P30 1:1080P50 9:720P25 2:1080i60 A: 1080P59.94 3:1080i50 B: 1080i59.94 4:720P60 C: 720P59.94 5:720P50 D: 1080P29.97 6:1080P30 E: 720P29.97 7:1080P25
Pan-tiltMaxSpeedInq	8x 09 06 11 FF	y0 50 ww zz FF	ww: Pan Max Speed      zz: Tilt Max Speed
Pan-tiltPosInq	8x 09 06 12 FF	y0 50 0w 0w 0w 0w 0z 0z 0z 0z FF	www: Pan Position      zzzz: Tilt Position





**Note:** [X] in the above table indicates the camera address to be operated, [y]=[x + 8].

### PELCO-D PROTOCOL COMMAND LIST

Function	Byte1	Byte2	Byte3	Byte4	Byte5	Byte6	Byte7
Up	0xFF	Address	0x00	0x08	Pan Speed	Tilt Speed	SUM
Down	0xFF	Address	0x00	0x10	Pan Speed	Tilt Speed	SUM
Left	0xFF	Address	0x00	0x04	Pan Speed	Tilt Speed	SUM
Right	0xFF	Address	0x00	0x02	Pan Speed	Tilt Speed	SUM
Upleft	0xFF	Address	0x00	0x0C	Pan Speed	Tilt Speed	SUM
Upright	0xFF	Address	0x00	0x0A	Pan Speed	Tilt Speed	SUM
DownLeft	0xFF	Address	0x00	0x14	Pan Speed	Tilt Speed	SUM
DownRight	0xFF	Address	0x00	0x12	Pan Speed	Tilt Speed	SUM
Zoom In	0xFF	Address	0x00	0x20	0x00	0x00	SUM
Zoom Out	0xFF	Address	0x00	0x40	0x00	0x00	SUM
Focus Far	0xFF	Address	0x00	0x80	0x00	0x00	SUM
Focus Near	0xFF	Address	0x01	0x00	0x00	0x00	SUM
Stop	0xFF	Address	0x00	0x00	0x00	0x00	SUM
Set Preset	0xFF	Address	0x00	0x03	0x00	Preset ID	SUM
Clear Preset	0xFF	Address	0x00	0x05	0x00	Preset ID	SUM
Call Preset	0xFF	Address	0x00	0x07	0x00	Preset ID	SUM
Query Pan Position	0xFF	Address	0x00	0x51	0x00	0x00	SUM
Query Pan Position Response	0xFF	Address	0x00	0x59	Value High Byte	Value Low Byte	SUM
Query Tilt Position	0xFF	Address	0x00	0x53	0x00	0x00	SUM
Query Tilt Position Response	0xFF	Address	0x00	0x5B	Value High Byte	Value Low Byte	SUM
Query Zoom Position	0xFF	Address	0x00	0x55	0x00	0x00	SUM
Query Zoom Position Response	0xFF	Address	0x00	0x5D	Value High Byte	Value Low Byte	SUM



## PELCO-P PROTOCOL COMMAND LIST

Function	Byte1	Byte2	Byte3	Byte4	Byte5	Byte6	Byte7
Query Zoom Position Response	0xFF	Address	0x00	0x5D	Value High Byte	Value Low Byte	SUM
Up	0xA0	Address	0x00	0x08	Pan Speed	Tilt Speed	0xAF
Down	0xA0	Address	0x00	0x10	Pan Speed	Tilt Speed	0xAF
Left	0xA0	Address	0x00	0x04	Pan Speed	Tilt Speed	0xAF
Right	0xA0	Address	0x00	0x02	Pan Speed	Tilt Speed	0xAF
Upleft	0xA0	Address	0x00	0x0C	Pan Speed	Tilt Speed	0xAF
Upright	0xA0	Address	0x00	0x0A	Pan Speed	Tilt Speed	0xAF
DownLeft	0xA0	Address	0x00	0x14	Pan Speed	Tilt Speed	0xAF
DownRight	0xA0	Address	0x00	0x12	Pan Speed	Tilt Speed	0xAF
Zoom In	0xA0	Address	0x00	0x20	0x00	0x00	0xAF
Zoom Out	0xA0	Address	0x00	0x40	0x00	0x00	0xAF
Stop	0xA0	Address	0x00	0x00	0x00	0x00	0xAF
Focus Far	0xA0	Address	0x01	0x00	0x00	0x00	0xAF
Focus Near	0xA0	Address	0x02	0x00	0x00	0x00	0xAF
Set Preset	0xA0	Address	0x00	0x03	0x00	Preset ID	0xAF
Clear Preset	0xA0	Address	0x00	0x05	0x00	Preset ID	0xAF
Call Preset	0xA0	Address	0x00	0x07	0x00	Preset ID	0xAF
Query Pan Position	0xA0	Address	0x00	0x51	0x00	0x00	0xAF
Query Pan Position Response	0xA0	Address	0x00	0x59	Value High Byte	Value Low Byte	0xAF
Query Tilt Position	0xA0	Address	0x00	0x53	0x00	0x00	0xAF
Query Tilt Position Response	0xA0	Address	0x00	0x5B	Value High Byte	Value Low Byte	0xAF
Query Zoom Position	0xA0	Address	0x00	0x55	0x00	0x00	0xAF
Query Zoom Position Response	0xA0	Address	0x00	0x5D	Value High Byte	Value Low Byte	0xAF



## Maintenance and Troubleshooting

---

### Maintenance

- Turn the camera off and disconnect the power adapter when not in use for an extended period.
- Use a soft cloth or tissue to clean the camera cover.
- Wipe the camera lens with a soft, dry cloth when cleaning. Gently wipe the lens with a mild detergent if needed. Do not spray the lens directly. Do not use strong or corrosive detergents to avoid scratching the lens and affecting the video quality.

### Troubleshooting

#### **No video output:**

- Check whether the camera power supply is connected, the voltage is normal, and the power indicator is lit.
- If using PoE ensure PoE is enabled on the port and switch has required power available.
- Check whether the camera can perform a self-test after restart.
- Verify that the output cable and display monitor are working properly.

#### **Image cuts out or appears abnormal:**

- Check whether the video output or video display is functioning correctly.

#### **Image distorts while came is moving or appears shaky:**

- Ensure the camera is installed in a solid position.
- Ensure there are no objects near the camera that can be transmitting vibration.

#### **Remote control does not work:**

- Check the remote control batteries.
- Verify the remote control address is set to 1.
- Verify the camera is in normal operating mode.
- Verify camera is not in the on-screen menu as the camera cannot be controlled in this mode.

#### **Serial Port is not working:**

- Verify that the camera serial device protocol, baud rate, and address are all correct.
- Check that the control cable is connected properly.
- Check whether the camera is in normal operating mode.

#### **Cannot connect to the web interface:**

- Check if the camera will output to a screen directly.
- Ensure the network cable is connected properly (green/yellow lights should be visible on the port and flashing indicating network activity)
- Verify you are connected to the same subnet as the camera and are not attempting to use the same IP address.



## Tech Support

---

Have technical questions? We may have answered them already!

Please visit BZBGear's support page ([bzbgear.com/support](http://bzbgear.com/support)) for helpful information and tips regarding our products. Here you will find our Knowledge Base ([bzbgear.com/knowledge-base](http://bzbgear.com/knowledge-base)) with detailed tutorials, quick start guides, and step-by-step troubleshooting instructions. Or explore our YouTube channel, BZB TV ([youtube.com/c/BZBTVchannel](http://youtube.com/c/BZBTVchannel)), for help setting up, configuring, and other helpful how-to videos about our gear.

Need more in-depth support? Connect with one of our technical specialists directly:

<b>Phone</b>	<b>Email</b>	<b>Live Chat</b>
1.888.499.9906	support@bzbgear.com	bzbgear.com

## Warranty

---

BZBGear Pro AV products and cameras come with a three-year warranty. An extended two-year warranty is available for our cameras upon registration for a total of five years.

For complete warranty information, please visit [bzbgear.com/warranty](http://bzbgear.com/warranty).

For questions, please call 1.888.499.9906 or email support@bzbgear.com.

## Mission Statement

---

BZBGear is a breakthrough manufacturer of high-quality, innovative audiovisual equipment ranging from AVoIP, professional broadcasting, conferencing, home theater, to live streaming solutions. We pride ourselves on unparalleled customer support and services. Our team offers system design consultation, and highly reviewed technical support for all the products in our catalog. BZBGear delivers quality products designed with users in mind.

## Copyright

---

All the contents in this manual and its copyright are owned by BZBGear. No one is allowed to imitate, copy, or translate this manual without BZBGear's permission. This manual contains no guarantee, standpoint expression or other implies in any form. Product specification and information in this manual is for reference only and subject to change without notice.

**All rights reserved.** No reproducing is allowed without acknowledgement.