

USER MANUAL

MODEL:

VIA GO²

**Wireless Presentation Solution
(For Firmware Version 3.2)**



Contents

Introduction	1
Getting Started	1
Overview	2
Glossary	3
Supported Devices	5
Defining VIA GO² Wireless Presentation Solution	6
For Installer: Mounting VIA GO²	7
For Installer: Connecting VIA GO²	8
Connecting Device	8
Connecting Main Display	9
For Web Administrator: Configuring Settings – Gateway Management Pages	10
Logging in to Gateway Management Pages	10
User Management	12
Managing Network Settings	12
VIA Pad Configuration	15
Site Management	17
VIA Screen Editor	18
Configuring VIA Settings Template	25
Integrating Third Party Calendar	33
Configuring Digital Signage	35
Maintaining Your VIA Unit	40
For Web Administrator: Configuring Settings – Gateway Dashboard	44
Logging in to Gateway Dashboard Settings	44
Changing LAN Settings	44
Accessing System Controls	45
For User: Running Kramer VIA App	46
Running Kramer VIA App for PC and Mac	46
Running Kramer VIA App for Tablets & Smartphones	46
Running Kramer VIA App from a Web Browser	47
Running Kramer VIA App Using an Installation File	47
For User: Participating in a VIA Meeting	48
Joining a VIA Meeting	48
Mirroring Your Device Screen	52
Technical Specifications	58
VIA App Android Permissions	59

Introduction

Welcome to Kramer Electronics! Since 1981, Kramer Electronics has been providing a world of unique, creative, and affordable solutions to the vast range of problems that confront the video, audio, presentation, and broadcasting professional on a daily basis. In recent years, we have redesigned and upgraded most of our line, making the best even better!

Getting Started

Congratulations on purchasing your Kramer **VIA GO² Wireless Presentation Solution**.

We recommend that you:

- Unpack the equipment carefully and save the original box and packaging materials for possible future shipment.
- Review the contents of this user manual.



Go to [www.kramerav.com/downloads/VIA_GO²](http://www.kramerav.com/downloads/VIA_GO2) to check for up-to-date user manuals, application programs, and to check if firmware upgrades are available (where appropriate).

Achieving Best Performance

- Use only good quality connection cables (we recommend Kramer high-performance, high-resolution cables) to avoid interference, deterioration in signal quality due to poor matching, and elevated noise levels (often associated with low quality cables).
- Do not secure the cables in tight bundles or roll the slack into tight coils.
- Avoid interference from neighboring electrical appliances that may adversely influence signal quality.
- Position your Kramer **VIA GO²** away from moisture, excessive sunlight and dust.



This equipment is to be used only inside a building. It may only be connected to other equipment that is installed inside a building.

Safety Instructions



Caution:

- This equipment is to be used only inside a building. It may only be connected to other equipment that is installed inside a building.
- For products with relay terminals and GPIO ports, please refer to the permitted rating for an external connection, located next to the terminal or in the User Manual.
- There are no operator serviceable parts inside the unit.

**Warning:**

- Use only the power cord that is supplied with the unit.
- Disconnect the power and unplug the unit from the wall before installing.
- Do not open the unit. High voltages can cause electrical shock! Servicing by qualified personnel only.
- To ensure continuous risk protection, replace fuses only according to the rating specified on the product label which is located on the bottom of the unit.

Recycling Kramer Products

The Waste Electrical and Electronic Equipment (WEEE) Directive 2002/96/EC aims to reduce the amount of WEEE sent for disposal to landfill or incineration by requiring it to be collected and recycled. To comply with the WEEE Directive, Kramer Electronics has made arrangements with the European Advanced Recycling Network (EARN) and will cover any costs of treatment, recycling and recovery of waste Kramer Electronics branded equipment on arrival at the EARN facility. For details of Kramer's recycling arrangements in your particular country go to our recycling pages at www.kramerav.com/il/quality/environment.

Overview

Congratulations on purchasing your Kramer **VIA GO² Wireless Presentation Solution**.

VIA GO² gives iOS, Android, Chromebook, PC, and Mac users instant wireless connectivity with 4K advanced presentation capabilities. The product features content streaming with crystal-clear mirrored images and stunning video playback and includes iOS mirroring via AirPlay™, Windows & Android mirroring via Miracast™, as well as ChromeBook mirroring. **VIA GO²** is super-compact (7x7cm) and flexible to install, with both built-in Wi-Fi and LAN connectivity and includes industry-leading 1024-bit encryption for secure use on the internal network.

Key Features

- **Quick and Reliable Wireless Connectivity** – A simple and intuitive user interface enables iOS, Android, Chromebook, PC, and Mac device users to instantly connect to a main display without a dongle. 2.4GHz/5GHz Wi-Fi and MIMO antennas establish and maintain a fast and reliable connection.
- **High Quality Video Streaming** – Supports up to 4K@30Hz resolution (using the VIA app Multimedia feature).
- **Simultaneous Display** – Two participants can simultaneously present content on main display.
- **VIA Product Integration** – Seamlessly compatible with VIA Site Management (VSM) Software & VIA Pad.
- **Easy and Flexible Installation** – With a super-compact 7x7cm form factor, it can be discreetly installed on the back of a display, projector or almost anywhere.

Typical Applications

- Presentation environments
- Small to mid–size meeting rooms
- Classrooms
- Huddle spaces

Glossary

The following are definitions of some common terms found in this User Manual.



Screenshots in this section are representative only and may not accurately reflect the features associated with your VIA device.

- VIA Meeting – A session where one or more users are logged into your VIA unit using the **Kramer VIA** app.
- Gateway – A VIA device such as **VIA GO²**.
- Main Display – Video display connected to the HDMI™ output of the gateway. This is where presentation and collaboration during the meeting happens.
- VIA App User Dashboard – Main interface for meeting participants using the **VIA** app. This dashboard appears after logging into a VIA meeting.



Figure 1: User Dashboard

- VIA Gateway Dashboard – VIA app interface used from the main display by either a keyboard and mouse connected to the gateway. Click the VIA icon in the lower left corner of the main display to open this interface.

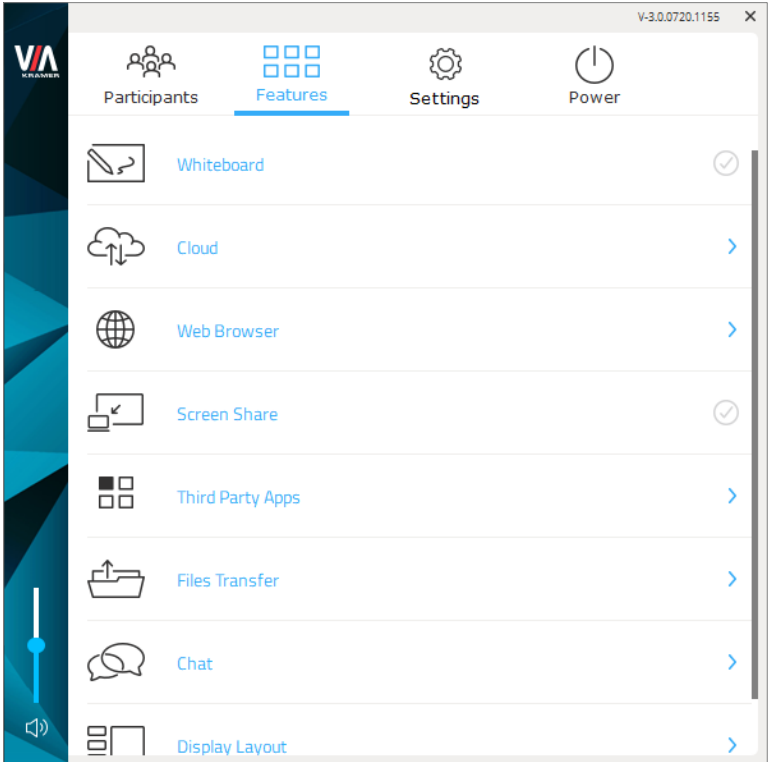

Figure 2: Gateway Dashboard

- Taskbar Menu – A menu of features that appears in your computer taskbar when you are logged into a VIA meeting using the **Kramer VIA** app.

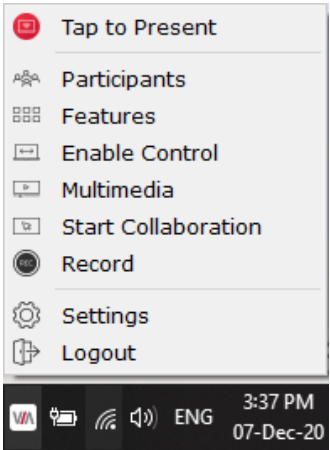

Figure 3: Kramer VIA Taskbar Menu

- Gateway Management Web Pages – Web pages embedded in your **VIA GO²** gateway that enable you to configure this gateway. The Gateway Management Web Pages are accessed from any computer connected to the same network as the gateway.

Supported Devices

The following user devices are supported by the **VIA GO² Wireless Presentation Solution**:

- Windows 8/10[®] (32-bit/64-bit) computer.
- Macintosh[®] computer, using OSX 10.12.x or newer.
- Chromebook.
- iPad/iPhone[®] tablet/smartphone (iPad 2 or later, iOS 12 or later).



When using the Airplay service, no Kramer VIA application is needed. However, we recommend using iOS12, Mojave OS X, or higher, for a better experience.

- Android[®] OS 5. x tablet/smartphone or newer.



The minimum system requirement for using the **Kramer VIA** mirroring feature for an Android device is Android 5.1.

Defining VIA GO² Wireless Presentation Solution

This section defines VIA GO².

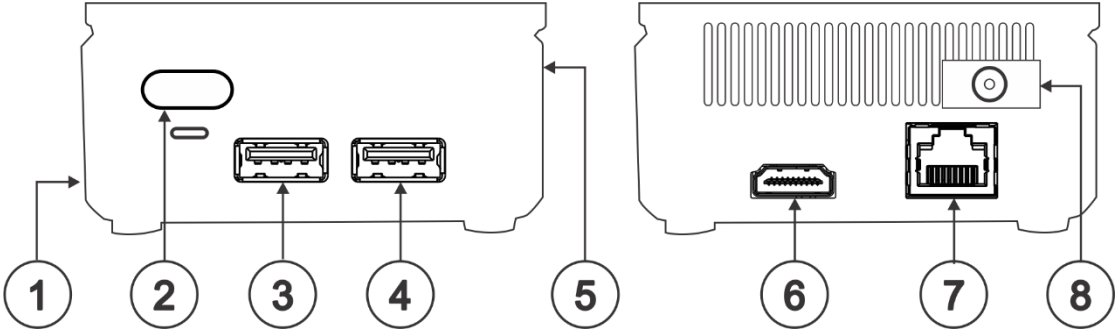

Figure 4: VIA GO² Wireless Presentation Solution

#	Feature	Function
①	Micro SD Card Slot	Not in use.
②	Power Button with LED	Press to power ON or turn OFF the device.
③	USB 3.0 Connector	Connect to a USB device, for example, a keyboard or mouse.
④	USB 2.0 Connector	Connect to a USB device, for example, a keyboard or mouse.
⑤	Lock Opening	Connect to a security locking cable.
⑥	HDMI™ Connector	Connect to an HDMI sink.
⑦	RJ-45 Connector	Connect to a LAN (default mode).
⑧	Power Connector	Connect to the 12V DC power supply.

For Installer: Mounting VIA GO²

This section provides instructions for mounting VIA GO². Before installing, verify that the environment is within the recommended range:



- Operation temperature – 0° to 40°C (32 to 104°F).
- Storage temperature – -40° to +70°C (-40 to +158°F).
- Humidity – 10% to 90%, RHL non-condensing.



Caution:

- Mount VIA GO² before connecting any cables or power.
- The device is intended to be installed at a height of 2 meters or less.



Warning:

- Ensure that the environment (e.g., maximum ambient temperature & air flow) is compatible for the device.
- Avoid uneven mechanical loading.
- Appropriate consideration of equipment nameplate ratings should be used for avoiding overloading of the circuits.
- Reliable earthing of rack-mounted equipment should be maintained.

You can install VIA GO² using one of the following method :

- Place the device on a flat surface.
- Place the device on a flat surface.
- Mount on a wall or the back of a display using the included VESA mounting bracket:

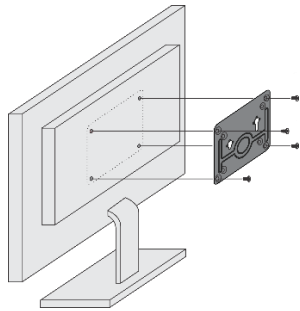

1. Attach the VESA mounting bracket to the back of the display with 4 screws.

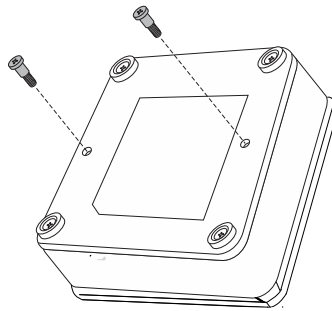

2. Fasten two screws to the bottom of VIA GO².

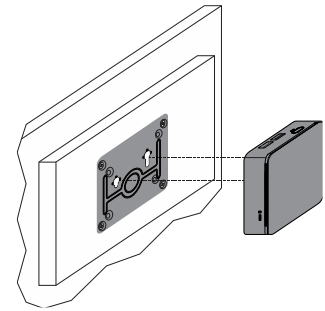

3. Insert the screws on the bottom of VIA GO² into the slots on the mounting bracket.



When mounting the device on a display, the installer **MUST** secure the display to prevent instability.

For Installer: Connecting VIA GO²

 Always switch off the power to each device before connecting it to your VIA GO². After connecting your VIA GO², connect its power and then switch on the power to each device.

Connecting Device

 If you wish to use a Kramer active optical pluggable HDMI cable with your VIA GO², contact your local Kramer office to assist in purchasing the correct cable.

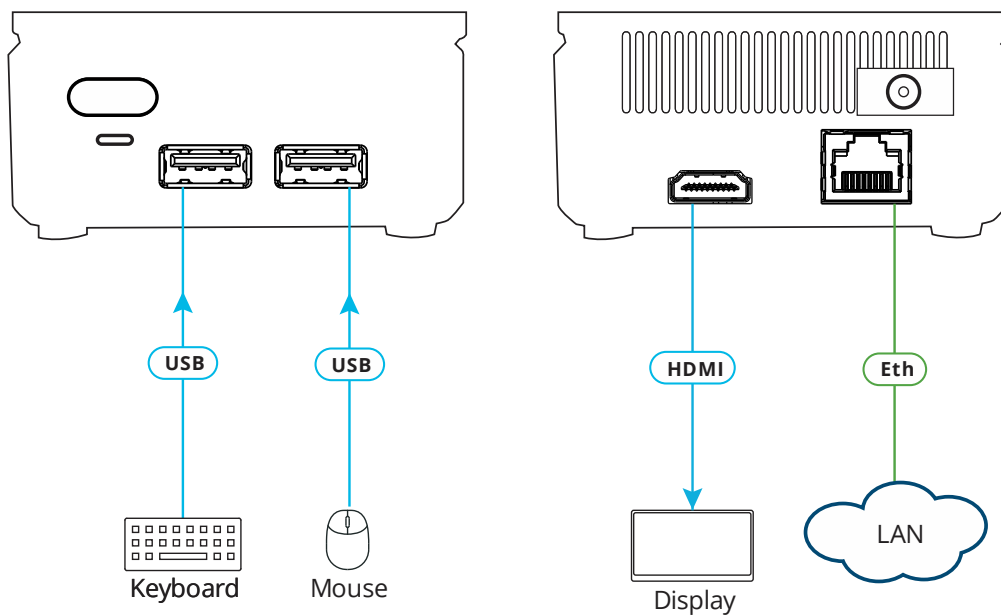



Figure 5: Connecting VIA GO²

To connect VIA GO² as illustrated in the example in [\(Figure 5\)](#):

1. Connect a keyboard and mouse to the USB 3.0 Connector [\(3\)](#) and the USB 2.0 Connector [\(4\)](#).
2. Connect an HDMI display to the HDMI Connector [\(6\)](#) to be used as the main display for the meeting (see [Connecting Main Display](#) on page [9](#)).
3. Connect the LAN (Local Area Network) cable to the RJ-45 connector [\(6\)](#)
-OR-
Connect to your network using a commercial wireless router.
4. Connect wirelessly with a supported device (see [Supported Devices](#) on page [5](#)) after installing the Kramer VIA app (see [For User: Running Kramer VIA App](#) on page [46](#)).

 To enable participation in a presentation session (send and receive content), connect VIA GO² and all participant devices (PCs/ MACs/ smartphones/tablets) to the same network (LAN or WLAN).

 For a list of supported devices, see [Supported Devices](#) on page [5](#).

Connecting Main Display

The main display is the screen connected directly to **VIA GO²**. When **VIA GO²** is booted up, the VIA gateway screen appears on the main display. All collaboration activity is then displayed here.

VIA GO² enables connecting the following display type:

VIA GO²'s internal video card reads the EDID (Extended Display Identification Data) for any connected display and sets the optimum display resolution and image refresh rate automatically through the display connectors.

For Web Administrator: Configuring Settings – Gateway Management Pages

VIA GO² enables users with Web Administrator access to configure settings for your VIA GO² unit.

VIA GO² enables you to do the following:

- [Logging in to Gateway Management Pages](#) on page [10](#).
- [User Management](#) on page [12](#).
- [Managing Network Settings](#) on page [12](#).
- [VIA Pad Configuration](#) on page [15](#).
- [Site Management](#) on page [17](#).
- [VIA Screen Editor](#) on page [18](#).
- [Configuring VIA Settings Template](#) on page [25](#).
- [Integrating Third Party Calendar](#) on page [33](#).
- [Configuring Digital Signage](#) on page [35](#).
- [Maintaining Your VIA Unit](#) on page [40](#).

Logging in to Gateway Management Pages

The Gateway Management Pages enable you to configure your VIA GO² gateway device. The Gateway Management Pages are accessed from any computer connected to the same network as your gateway.

To log in to the VIA GO² Gateway Management Pages:

1. Connect your computer to the same network to which VIA GO² is connected.
2. Open a Web browser and go to the IP address for your VIA GO² unit.
The Gateway Management Pages Welcome page appears.
3. Click **Manage Gateway Settings** in the upper right corner.
The Administrator Login page appears.
4. Type a Web Administrator Username (default = su) and Password (default = supass).



You must log in as a user with Web Administrator user role to access settings through the Gateway Management Pages (see [User Management](#) on page [12](#)).

5. Type the two Captcha Text strings with a space between them in the text box.



To disable the Captcha see [Security](#) on page [31](#)).

6. Click **Login**.

The Gateway Management Pages appear with the Dashboard open.



Click the tabs in the navigation pane on the left to display the VIA web pages.



Click the arrow in the upper right corner to select a different language for the web pages.

User Management

This section describes how to add user accounts to the database of your **VIA GO²** device. A user account is required to access the Gateway Management Pages (see [Logging in to Gateway Management Pages](#) on page [10](#)) and, when your **VIA GO²** is in Database mode (see [Moderator Mode](#) on page [28](#)), a user account is required to join a VIA meeting.

To add a user account to your VIA GO² database:

1. Click **User Management** on the Gateway Management Pages navigation pane.
The User List page appears.
2. Click **Add User**.
The Add User pane appears.
3. Type the new Username, Password and Confirm Password.
4. Under User Role, select from the following administrative levels:
 - **Web Administrator** – Access to change all system settings, including Digital Signage.
 - **Digital Signage** – Able to configure the Digital Signage only (see [Configuring Digital Signage](#) on page [35](#)).
5. Select one of the following participation levels:



These options are enabled only when Moderator Mode is enabled (see [Moderator Mode](#) on page [28](#)).



- **Moderator** – User is able to become a moderator and has access to moderator features (see [Becoming Meeting Moderator](#) on page [56](#)).
 - **Participant** – User can join a meeting as a participant but cannot access moderator features.
6. Click **Save**.
A new user is added, and the User List tab appears with the new user added to the list.

Managing Network Settings

VIA GO² enables you to do the following:

- [Changing Device IP Address](#) on page [13](#).
- [Setting Up Secure Wireless Guest Access Point](#) on page [13](#).
- [Connecting VIA GO² to Network Wirelessly](#) on page [14](#).
- [Connecting VIA GO² to 802.1x Network](#) on page [14](#).
- Uploading an SSL Certificate (see [Certificate](#) on page [31](#)).

Changing Device IP Address

-  The default IP setting is DHCP that assigns an automatic IP address to your **VIA GO²** device. This enables easy plug and play setup when connecting your **VIA GO²** to the network. The following explains how to change a static IP address.
-  When changing these settings, please contact your IT administrator. Incorrect values can cause a loss of communication.

To change the IP address of your VIA GO² unit:

1. Click **Device Management > Network Settings**.
The Network Settings page appears.
2. Under Connection Type, select **Static**.
3. Under Network Information, change the IP settings.
4. Click **Apply**.
The IP address of your **VIA GO²** unit is changed.

Setting Up Secure Wireless Guest Access Point

Using the built-in Wi-Fi module, **VIA GO²** enables you to set up a secure access point for users to connect to your **VIA GO²** network. This setup is ideal for guest users whom you may not want to connect directly to your network.

To set up a secure wireless guest access point:

1. Click **Device Management > Network Settings**.
The Network Settings page appears.
2. Click **WiFi**.
The WiFi tab appears.
3. Click the **Switch On or Off Wifi** switch.
The switch turns green and the WiFi settings appear.
4. Click **AP Mode** and enter a new name in the SSID field and a new password.
5. Select **Enable Internet** if your **VIA GO²** device is connected to a network with internet.
-OR-
Select **Activate Standalone Wifi** to create an autonomous network without Internet access.
6. If you selected Enable Internet, you can also select **Enable Guest Mode** to let meeting participants enable Access Point mode from the VIA taskbar menu.

-  When in Moderator Mode (see [Moderator Mode](#) on page [28](#)), only the moderator can enable the Access Point.

7. Click **Apply**.
The secure wireless guest access point is set up.

Connecting VIA GO² to Network Wirelessly

VIA GO² enables you to wirelessly connect your VIA GO² device as a client device to your main network.

To set up Client Wi-Fi mode:

1. Click **Device Management > Network Settings**.
The Network Settings page appears.
2. Click **WiFi**.
The WiFi tab appears.
3. Click the **Switch On or Off Wifi** switch.
The switch turns green and the WiFi settings appear.
2. Click **Client Mode**.
3. Click OK for the notification.
The Client Mode tab appears.
4. If you do not see the desired network in the dropdown, click **Click Here to Scan all Networks**.
5. Select an available network from the drop-down.
6. Enter the network password and click **Apply**.
7. Disconnect the LAN cable (if connected) and reboot the device.
Client Wi-Fi Mode is set up.

Connecting VIA GO² to 802.1x Network

VIA GO² enables you to wirelessly connect your VIA GO² device as a client device to an 802.1x network using a password based or an EAP-TLS based authentication mechanism.

Features of EAP-TLS include:

- Mutual authentication (server to the client and client to server).
- Key exchange to establish dynamic WEP or TKIP keys.
- Fragmentation and reassembly of very long EAP messages, if needed.
- Fast reconnect via TLS session resumption.

To Connect VIA GO² as a client device to an 802.1x network:

1. Set up a Radius server to validate the certificate that you will upload to VIA GO².
2. Set up an access point (AP) with 802.1x type security.



The Radius server IP address and password will be passed while configuring the 802.1x security type on the access point. This password is the same one that is used in the Radius server.

3. Click **Device Management > Network Settings** in the navigation pane.

The Network Settings page appears.

4. Click **WiFi**.

The WiFi tab appears.

5. Click the **Switch On or Off Wifi** switch.

The switch turns green and the WiFi settings appear.

4. Click **Client Mode**.

5. Click **OK** for the notification.

The Client Mode tab appears.



If you do not see the desired network in the dropdown, click **Click Here to Scan all Networks**.

6. Do one of the following:

- To connect to the network with username and password authentication, select the SSID of the access point that is secured by 802.1x.

Your unit can now connect to the network with a username and password.

-OR-

- To connect to the network with EAP-TLS authentication:

- a. Select the 802.1x (TLS Certificate) checkbox.

Additional settings appear.

- b. Enter the Identity.

- c. Upload the Authority CA, User Certificate and Key files and click **Apply**.

VIA GO² automatically reboots and is now connect to the 802.1x network.

VIA Pad Configuration

VIA Pad is an optional touch-pad accessory that enables meeting participants to instantly join a VIA meeting with their Mac or PC laptop. Before connecting **VIA Pad** to a participant device for the first time, VIA must be paired with your **VIA GO²** device. The pairing procedure includes:

- [Configuring VIA Pad Settings](#) on page [16](#).
- [Pairing a VIA Pad Device](#) on page [17](#).

Configuring VIA Pad Settings

VIA GO² enables you to configure VIA Pad settings that define how a VIA Pad device operates when paired with your VIA GO² unit.

To configure VIA Pad settings:

1. Click **Device Management > VIAPad Configuration** on the navigation pane.
The VIAPad Configuration page appears.
2. Select the following as required:
 - **Guest** – Participant can Present by touching the VIA Pad device; the **Kramer VIA** app dashboard is not available.
 - **VIA Pad overrides Room Code** – Participant can join a meeting without entering the room code.



Room Name is automatically populated; it reflects the name of your VIA GO² unit.

3. Select the **Auto Connect to Wi-Fi** checkbox, to configure VIA Pad to automatically connect to the meeting space Wi-Fi network.

The Auto Connect settings appear.

4. Define the following for the meeting space Wi-Fi network:

- a. SSID – Name of the network



Make sure that you write it EXACTLY as defined. This parameter is case sensitive.

- b. Authentication Mode – Security used by your Wi-Fi access point. Select from the pre-set options: **WEP Open, WEP Shared, WPA Personal, WPA2 Personal**.

- c. Encryption – Type of encryption key used by your router.

- d. Key – Password required to join your network (up to 50 characters max).

VIA Pad settings are configured.



After clicking Apply Settings, the configuration is saved, there is no need to reboot your unit.

Pairing a VIA Pad Device

Each **VIA Pad** device must be paired to your **VIA GO²** unit before being used by a meeting participant.

To pair a VIA Pad device to your VIA GO² unit:

- Follow the directions below:



Site Management

VSM (VIA Site Management) is an optional, web-based software application (purchased separately) that enables an administrator to monitor and make changes to all VIA gateways connected to a network. **VIA GO²** enables you to activate VSM management for a VIA gateway and define which gateway functions are managed by VSM.



Contact your regional sales representative for more details about this solution.



If VIA discovery is enabled and configured in VSM, your VIA device is automatically added under VSM supervision.

To configure **VIA GO²** to be managed by VSM when VIA discovery is not activated:

1. Click **Device Management** > **Site Management** on the navigation pane.

The VIA Site Management page appears.

2. In the Step 1: Server Settings section, enter the VSM Server IP and the Gateway ID that was defined in VSM for this gateway.

3. Click **Validate and Save**.

Changes take effect immediately.



VIA GO² must be able to connect to VSM while validating is in progress.

-OR-

Click **Save** for changes to be saved with no validation from VSM.



Since validation is not made immediately, any error entered at this stage, like duplication of ID, must be corrected manually at a later stage.

- In the Step 2: Configuration section, in the VSM column, select all functions that you want to be managed by VSM.



After clicking Apply and Reset, changes take 30 minutes to 1 hour to take effect, to allow time to communicate with VSM.

VIA Screen Editor

VIA GO² enables you to customize the look and feel of the main display home screen:

- [Creating New Screen Layout](#) on page [18](#).
- [Formatting Screen Layout Widgets](#) on page [19](#).
- [Editing a Screen Layout](#) on page [24](#).
- [Deleting a Screen Layout](#) on page [24](#).
- [Exporting and Importing a Screen Layout](#) on page [24](#).

Creating New Screen Layout

VIA GO² enables you to custom design the screen layout for the main display. You can incorporate your company branding, as well as display custom text, date & time, and meeting login information. Create and save several versions of the screen layout and load them as needed.

To create a new screen layout for the main display:

- Click **Device Management > VIA Screen Editor** on the Gateway Management Pages navigation pane.
The Screen Editor page appears.
- Click **Add Screen Layout**.
The wallpaper upload window appears.
- Drag an image file to the window or click **Upload a photo from your computer** and select an image file from your computer.





Wallpaper image files must be jpeg, png, or bmp format and a maximum size of 2 MB.

If the wallpaper image resolution does not match VIA's output resolution, the screen layout elements may not appear in the same location as they do in the Screen Editor. For best results, use a wallpaper image that matches the output resolution of VIA.

The Screen Editor window appears with the selected image in the work area.

- Drag one of the following widgets (screen elements) from the left side of the window into the workspace in the middle:
The widget appears on the screen layout preview and the property controls appear on the right of the preview.

5. Format the widget with the property controls on the right side of the window (see [Formatting Screen Layout Widgets](#) on page 19).
 6. Click and drag the widgets according to your preferred screen layout.
-  Select the **Gridlines** checkbox to show a grid overlay that helps position elements on the layout.
-  To remove a widget from the screen layout, click the X in the upper right corner of the widget.
7. Click **Save**.
The new layout is saved and will appear in the table of layouts on the Screen Editor page.
 8. Click **Publish**.
The new screen layout appears on the main display.

Formatting Screen Layout Widgets

VIA GO² provides different formatting options for each of the screen layout widgets (elements). You can define the position, color, format (for date and time) and refresh time (for Room Code) of these elements. In addition, you can display a customized DNS (Domain Name System) name instead of the default room name, if local DNS services are supported by the network and a DNS server is defined (see [Changing LAN Settings](#) on page 44).

Formatting Text

Format the following on the Properties tab:

- Enter the text in the text field.
- Select the font size and text alignment.
- Under Auto Resize, click **ON** to automatically resize the box to fit the size of the text. When the layout is published, on the main display the box size adjusts to fit the size of the text.

Format the following on the Color tab:



- Click the Background color box and select a fill color for the text box.
- Select the opacity of the text box.
- Click the Font Color box and select a font color.
- Under Border, click **ON**, click the Border Color box and select a border color.

Formatting Room Name 1

Room Name 1 is the address used join a meeting.

Format the following on the Properties tab:

- In the Room Name field, you can enter one or both of the following:
 - #roomname# – Automatically displays the IP address of the meeting space (default).

- #airplayname# – Automatically displays the airplay name of the meeting space, (see [Mirroring Apple Laptops and iPhones Using iOS/OS X Airplay Service](#) on page [54](#)).
 - In the Custom Room Name field, enter a custom name for the meeting space. This name appears in place of the meeting space IP address when #roomname# is used in the Room Name field (see bullet above).
-  If you enter a name in the Custom Room Name, it does not change the IP address, but adds a custom name that can make it easier to identify the meeting space. This name appears in the meeting space list along with the IP address. A participant can start typing the custom name instead of the IP address to join the meeting (see [Joining a VIA Meeting](#) on page [48](#)).
-  Custom room names only work if DNS has been configured to properly redirect the Room Name to the appropriate IP address or if broadcast is working in your network environment. We recommend adding a text field and including the VIA's IP address on the wallpaper as well as the custom name.
- Under Show Room Name on second Display also, click **ON** to show the room name on both displays, when using dual displays (see [Connecting Main Display](#) on page [9](#)).
 - Under Room Name Overlay:
 - Click **ON** to always show the room name on top of all content being presented on the screen.
 - Select the number of seconds the room name overlay is visible on top of participant content.
 - Select the font size and text alignment.
 - Under Auto Resize, click **ON** to automatically resize the box to fit the size of the text. When the layout is published, on the main display the box size adjusts to fit the size of the text.

For formatting on the Color tab, see [Formatting Text](#) on page [19](#).

Formatting Room Code

Room Code is the four digit code that participants need to join the meeting.

Format the following on the Properties tab:

- Under Always show on wallpaper, click **ON** to always show the room code on the main display background. The code will be hidden if there is content covering it.
- Under Show Room Code on second Display also, click **ON** to show the room code on both displays, when using dual displays (see [Connecting Main Display](#) on page 9).
- Under Room Code Refresh Time, select the time, in minutes, for how long a room code remains before changing to a different code.
- Select the font size and text alignment.
- Under Auto Resize, click **ON** to automatically resize the box to fit the size of the text. When the layout is published, on the main display the box size adjusts to fit the size of the text.

For formatting on the Color tab, see [Formatting Text](#) on page 19.

Formatting Code Popup

Code Popup shows the Room Code only when a participant enters the Room Name on **Kramer VIA** app to join the meeting. This popup appears on top of any content being presented on the main display.

Format the following on the Properties tab:

- Select the font size and text alignment.

For formatting on the Color tab, see [Formatting Text](#) on page 19.

Formatting Date

The Date widget displays the date according to the time zone settings of the VIA device (see [Date/Time](#) on page 28).

Format the following on the Properties tab:

- Select one of the following date formats:
 - **DD MON, YYYY** – Day Month, Year (for example: 1 January, 2019).
 - **MON DD, YYYY** – Month Day, Year (for example: January 1, 2019).
 - **DD MON** – Day Month (for example: 1 January).
 - **MON DD** – Month Day (for example: January 1).
- Select the font size and text alignment.
- Under Auto Resize, click **ON** to automatically resize the box to fit the size of the text. When the layout is published, on the main display the box size adjusts to fit the size of the text.

For formatting on the Color tab, see [Formatting Text](#) on page [19](#).

Formatting Time

The Time widget displays the time according to the time zone settings of the VIA device (see [Date/Time](#) on page [28](#)).

Format the following on the Properties tab:

- Select **24 hour** or **AM/PM** time format.
- Select the font size and text alignment.
- Under Auto Resize, click **ON** to automatically resize the box to fit the size of the text. When the layout is published, on the main display the box size adjusts to fit the size of the text.

For formatting on the Color tab, see [Formatting Text](#) on page [19](#).

Formatting Date & Time

The Date & Time widget displays the date and time according to the time zone settings of the VIA device (see [Date/Time](#) on page [28](#)).

Format the following on the Properties tab:

- Select **24 hour** or **AM/PM** time format.
- Select the font size and text alignment.
- Under Auto Resize, click **ON** to automatically resize the box to fit the size of the text. When the layout is published, on the main display the box size adjusts to fit the size of the text.

For formatting on the Color tab, see [Formatting Text](#) on page [19](#).

Formatting QR Code

The QR Code widget is a QR code that enables a participant to join the meeting by scanning the code with their device.

Format the following on the Properties tab:

- Under Enable QR code, click **ON** to enable joining the meeting using the QR code.
- Under Bypass room code, click **ON** to enable joining the meeting using the QR code without entering the room code.
- Under Keep QR code always on top, click **ON** to always show the QR code on top of all content being presented on the screen.



To download and print a hard copy of the QR code to post in the meeting space, go to the Screen Editor page and click the QR code icon in the Preview column of the active screen layout.

Formatting Calendar

The Calendar widget displays information about meetings scheduled in the room where the VIA device resides.



The VIA Calendar feature must be configured and activated to use this widget (see [Integrating Third Party Calendar](#) on page [33](#))

Format the following on the Properties tab:

- Select **24 hour** or **AM/PM** time format.
- Under Show Title, click **ON/OFF** to show/hide the meeting title.
- Under Show Organizer, click **ON/OFF** to show/hide the name of the meeting organizer.
- Under No. of Records to display, select how many upcoming meetings to display
- Under Please choose font size, select the font size.

Format the following on the Color tab:

- Click the Background color box and select a fill color for the calendar.
- Select the opacity of the calendar.
- Click the Meeting Tile Font Color box and select a font color.
- Select a bar color for the following meeting statuses:
 - In Use.
 - Available.
 - Upcoming.

Formatting Timer

The Timer widget is a pop-up that displays a notification that counts down the last several minutes before the next meeting is scheduled to start in the room.

Format the following on the Properties tab:

- Under Please choose top and bottom text font size, select the font size for text appearing above and below the time.
- Under Please choose middle text font size, select the font size for the time.
- Under Meeting alert display, select the amount of time before the next meeting to display the notification and start the countdown.

For formatting on the Color tab, see [Formatting Text](#) on page [19](#).

Editing a Screen Layout

To edit a screen layout:

1. Click **Device Management > VIA Screen Editor** on the navigation pane.
The Screen Editor page appears.
2. Click **Edit** in the row of the layout that you want to edit.
The Screen Editor window appears.
3. Edit the layout as desired (see [Creating New Screen Layout](#) on page 18).
4. Click **Save**.
The screen layout edits are saved.

To save the edited screen layout as a new layout:

1. Click the arrow next to Save and select **Save As**.
The template name window appears.
2. Enter a new name for the layout and click **Submit**.
The edited layout is saved as a new layout.

Deleting a Screen Layout

To delete a screen layout:

1. Click **Device Management > VIA Screen Editor** on the navigation pane.
The Screen Editor page appears.
2. Select the layout that you want to delete and click **Delete**.
A confirmation message appears.
3. Click **OK**.
The selected screen layout is deleted from the VIA device and removed from the list.

Exporting and Importing a Screen Layout

VIA GO² enables you to export a screen layout in the form of a .screen file to share and to use on other VIA devices.

To export a screen layout:

1. Click **Device Management > VIA Screen Editor** on the navigation pane.
The Screen Editor page appears.
2. Select the checkbox at the end of the row of the layout that you want to export and click **Export Templates**.
A confirmation message appears.
3. Click **OK**.
A screen layout file (.screen) is downloaded to your device.

To import a screen layout:

1. Click **Device Management > VIA Screen Editor** on the navigation.
The Screen Editor page appears.
2. Click **Import Templates**.
A file browser window appears.
3. Select the desired screen layout file and click **Choose**.
The selected file is uploaded to **VIA GO²** and the imported layout appears in the screen layout list.



Make sure that the exported layout file fits the resolution of the VIA device to which it is imported.

Configuring VIA Settings Template

VIA GO² enables you to configure settings such as power saver, time & date, audio and features availability and save them as part of a settings template. This enables you to define and save different settings for different types of meetings. Just load the appropriate template to match your needs.

To create a new gateway settings template:

1. Click **DEVICE MANAGEMENT > VIA Settings** on the navigation page.
The VIA Settings page appears.
 2. Click **Create New Template**.
The Configurations Template Creation page appears.
 3. Enter a name for the new template and click **Apply**.
The new template is saved.
 4. Open the different settings pages by clicking on the navigation pane on the left and change settings as needed.
 5. As you change settings on each page, do one of the following:
 - a. Click **Update Template** to update the template without resetting and applying this template.
Changes are saved and the template remains open for more edits.
- OR-
- b. Click **Publish & Exit** to update the template and apply the newly edited template.
Changes are saved to the template, and the session resets with the new template applied. This will take several moments, and you will need to log back into the Gateway Management pages.

VIA GO² enables you to configure the following types of settings that apply to the settings template:

- [System](#) on page [26](#).
- [Presentation](#) on page [27](#).
- [Power](#) on page [28](#).
- [Date/Time](#) on page [28](#).
- [Moderator Mode](#) on page [28](#).
- [Audio](#) on page [30](#).
- [Security](#) on page [31](#).
- [Certificate](#) on page [31](#).
- [NTP](#) on page [32](#).
- [Proxy Server](#) on page [32](#)
- [Features](#) on page [32](#)
- [Configuring Display Controller](#) on page [33](#)

System

Configure the following settings in the VIA settings template (see [Configuring VIA Settings Template](#) on page [25](#)) that affect the overall operation of the system:

- Activating System Log – Provides a log of system activities such as logins, presentation, and VIA features usage to aid in diagnosing a problem or tracking participant usage. (default = OFF)



To view and search Activity Logs, (see [Viewing and Searching System Activity Logs](#) on page [40](#)).

- Activate Energy Saver Mode – Automatically send your **VIA GO²** unit into sleep mode after being inactive for a defined period of time. After activating this feature, select the period (in minutes) from the Sleep Time field. (default = OFF)
- Quick Client Access – Display a shortcut in the bottom left corner of the main display to open the VIA gateway dashboard. (default = ON)
- Quick Client Access - Always on Top – When ON, the VIA gateway dashboard always appears on top of all content on the main display. (default = ON)
- API Settings Command – Select one of the following:
 - Secure - API Commands can be sent to the VIA gateway securely over a TLS port.
 - Non-Secure - API Commands can be sent to the VIA gateway on a non-secure, plain-text port. Use this mode if your controller does not support TLS. (default)
- Language – Select the language for the Gateway Management pages.
- VIA Auto Broadcast Info – **VIA GO²** can broadcast a signal to all **Kramer VIA** client applications connected to the same network (same VLAN). When a user starts to join

a meeting, all VIA gateways that are broadcasting, automatically appear on the user's meeting room list (see [Joining a VIA Meeting Manually](#) on page 48). (default = ON)



For information on how Auto Broadcast is enabled and what are its limitations, refer to the VIA IT Deployment Guide, available for download at: [www.kramerav.com/downloads/VIA GO²](http://www.kramerav.com/downloads/VIA_GO2).

- Hide VIAAdmin at the client side – Hides the VIAAdmin user from the Participants list. (default = OFF)

Presentation

Configure the following settings in the VIA settings template (see [Configuring VIA Settings Template](#) on page 25) that affect how participants share content during a meeting:

- iOS Mirroring – The VIA gateway will act as an Apple® AirPlay receiver. If desired, type a new Mirror Name (the name that appears when you look for AirPlay devices on your iOS device) and select the maximum number of mirrored iOS devices that can be used simultaneously. (default = OFF)
- Join through Browser – Enables users that are sitting in the meeting room to join the VIA meeting from a web browser, without downloading any software. (default = ON)
- Miracast Settings – Enables users to mirror their device screens using the native Miracast feature on their Windows 10 laptop or Android device without using the VIA app. (default = OFF)



If you are using the built-in Wi-Fi for Client or AP mode, a **VIAcast** dongle (purchased separately) is needed to provide Miracast mirroring for meeting participants. For more information see: www.kramerav.com/product/VIAcast.

- Reset Session – Enables all users to reset the current VIA session from an icon that appears in the VIA task bar menu. (default = ON)
- Default Encoding for Presentation – PC & Mac clients connected to the VIA gateway default to the encoding method selected here. (default = Auto/H264)
- Auto DND – The DND (Do Not Disturb) feature prevents anyone but the active presenter from presenting. Auto DND activates DND when a user starts presenting from their device. (default = OFF)
- Do Not Disturb – After a participant clicks the Present button, they are given the option to enable or disable DND. (default = OFF)
- Local Annotation – Users can annotate locally on their device while using the View Main Display feature. If this feature is not activated, users can only view, but not annotate. (default = ON)
- Public Annotation – Users can start public annotation while using the View Main Display feature. When public annotation is started, the user's local annotation appears live on the main display, and the whiteboard tools are shown. (default = ON)
- Presentation Always in full Screen – Only one user at a time can present. When a new presentation is started, the current presentation stops. (default = OFF)

Power

Configure the following energy-saving automatic power settings in the VIA settings template (see [Configuring VIA Settings Template](#) on page 25):

- Auto Power Off Timing – Set a time for **VIA GO²** to automatically shut down each day.
- Auto Reboot Timing – Set a time for **VIA GO²** to automatically reboot each day.

Date/Time

Configure the following settings in the VIA settings template (see [Configuring VIA Settings Template](#) on page 25) that define the date and time displayed on the Gateway Management Pages:

- Date and Time Format for Web Interface – Select the format for displaying the date and time on the Dashboard page.
- VIA Gateway Timezone Configuration – Select the time zone for **VIA GO²**.

Moderator Mode

A meeting moderator has control over certain VIA functions that affect other participants (see [Becoming Meeting Moderator](#) on page 56). Moderator Mode settings define who can become the meeting moderator and what features are activated when a participant becomes the moderator.

When Moderator mode is configured as “Database based” or “Active Directory” you can also define who can join a VIA meeting.

Configure the following settings in the VIA settings template (see [Configuring VIA Settings Template](#) on page 25) that affect Moderator Mode and user accounts:

- Activate Moderator Mode – Allow participants to become moderator of a meeting. When this feature is activated, a Become Moderator button appears for each eligible participant on the Participants tab of the user dashboard.

Select one of the following to define who can join a meeting and who can become moderator:

- **Database Based** – Only users with accounts created in **VIA GO²** database can join a meeting and become moderator (see [User Management](#) on page 12).
- **Active Directory** – Only users defined in the Active Directory can join a meeting and become moderator (see [Configuring Active Directory Moderator Mode](#) on page 30).
- **Basic** – Anyone can join a meeting and become moderator. To require a password before becoming moderator, (see [Security](#) on page 31).

If required, select one or more of the following checkboxes that define what special features are available to a moderator:

- **Wait for Moderator to Start Session** – VIA session does not start until a moderator joins the meeting. Participant dashboard features are grayed out and a message appears on the main display.



This feature is not available in Basic Moderator Mode.

Configuring Active Directory Moderator Mode

VIA GO² enables you to import users from an Active Directory without having to create them in the Gateway Management Pages. The Active Directory must be organized into two sets of users: one that has permission to become moderator and one that does not have moderator permission. When using Active Directory, only users that are in the directory can join a VIA meeting.



You can use Groups or OUs (Organizational Units) to divide the moderator and participant/non-moderator set of users.



Do not use Groups or OUs that have any employee in common. If there is overlap of users in your existing Groups, you will have to create new Groups for this purpose.

To configure Active Directory Moderator Mode:

1. Click the **Activate Moderator Mode** switch and select **Active Directory**.
The Active Directory settings appear.
2. In the **Active Directory Domain** text box, enter the Active Directory domain name.
3. Select User principal name or Same account name.
4. Select the **Group Based** or **OU Based** radio button as per your Active Directory configuration.
5. Based on the above selection, type the name of the Moderator and Participant Group/OU in their respective boxes.

Active Directory Moderator Mode is configured.



VIA GO² does not discover and connect to the Active Directory; rather it relies on you to correctly enter the details. If there is a typographical error in any of the fields, the users (Moderators and Participants) cannot log in.



For further details, refer to “VIA Integration into DNS and Microsoft Active Directory” white paper.

Audio

Configure the following audio related settings in the VIA settings template (see [Configuring VIA Settings Template](#) on page 25):

- VIA Gateway Audio Input – Not relevant for **VIA GO²**.
- VIA Gateway Audio Output – Not relevant for **VIA GO²**.
- Default Audio Level – After rebooting the unit, resetting a session, or returning to a meeting after all users have logged off, the volume returns to this defined level.

Security

Configure the following settings in the VIA settings template (see [Configuring VIA Settings Template](#) on page 25) that affect login security for the Gateway Management Pages and for VIA meetings:

- Web Session Timeout –Select the amount of idle time before an administrator is automatically logged out of the Gateway Management Pages.
- Captcha – Turn ON or OFF the captcha challenge when logging into the Gateway Management Pages.

The following Password Policy settings affect new user accounts for logging into the Gateway Management Pages and joining a VIA meeting:

- Alphanumeric – Require at least one letter and one number to be included in a user password.
- At least one special character – Require at least special character (like: !, @, #) to be include in a user password.
- At least one capital letter – Require at least one capital letter to be include in a user password.
- Password minimum length – Define a minimum number of characters for a user password.
- Apply password policy on basic mode – Require all the above rules when creating the Basic mode password (below).
- VIA basic password – Define the password needed to become moderator when in Basic mode (see [Moderator Mode](#) on page 28). To remove the password requirement, clear the password field.

Certificate

VIA GO² enables you to upload a custom SSL certificate to better provide for the security needs of your organization.



To prevent damage to the system, make sure you upload files that can be used by the system. If you are unsure of how to use this feature, contact technical support.

For information on how to create a certificate, see Creating an SSL Certificate for VIA, available at: [www.kramerav.com/product/VIA GO²](http://www.kramerav.com/product/VIA GO2)

After obtaining your certificate, install it on your VIA device.



The uploaded files must stay in the format of “server.crt” & “server.key”.

To upload an SSL certificate:

1. On the Certificate tab in the VIA settings template (see [Configuring VIA Settings Template](#) on page 25), copy and paste the web server certificate.

The web server certificate is uploaded.



Do not upload the key file until the certificate file is finished uploading.

2. Copy and paste the key file.

The key file is uploaded.

NTP

VIA GO² enables you to add an NTP (Network Time Protocol) server to synchronize your VIA gateway time.

To add an NTP server:

- In the NTP tab in the VIA settings template (see [Configuring VIA Settings Template](#) on page 25), enter the NTP server address and click **Add**.

The new NTP server is saved and appears in the NTP Server table.



To edit an NTP server name, click the icon in the Edit column.

To delete an NTP server name, click the icon in the Delete column.

Proxy Server

VIA GO² enables you to define a proxy server that will handle all URLs that are used during your VIA meeting (for example, Youtube URLs used for the Youtube player feature) and for firmware downloads.

To define a proxy server:

- In the Proxy Server tab in the VIA settings template (see [Configuring VIA Settings Template](#) on page 25), enter your proxy server parameters.

After entering the parameters, click **Test Proxy Server** to verify that all parameters were entered correctly and that a connection has been established.

Features

VIA GO² enables you to rearrange the position of features in the VIA user menu and hide features from the menu. Each of the following web pages enables managing a different features menu:

- Gateway Features – Menu available on the main display.
- Client Features – Menu available on meeting participant laptops and tablets
- Mobile Features – Menu available on meeting participant smartphones

To configure features arrangement and availability:

1. Scroll down on the Configurations Template Creation navigation pane, and click **GO 2 > Gateway /Client /Mobile Features**.
2. Click and drag feature icons to a new position as needed.
3. Click the switch next to a feature icon.

The switch turns black, showing that the feature is now hidden.

Changes are reflected in the menu after the new template is published.



Hidden features move to the bottom of the list.

Configuring Display Controller

VIA GO² enables you to control a display screen that is connected to the same network as your **VIA GO²**.

This feature enables you to configure one of the following actions:

- When the first person joins the meeting, the main display powers ON and when the last person logs out of the meeting, the main display powers OFF.
- Send a switch HDMI Input command, to toggle between the VIA input and any other device connected to the same display.

To configure your VIA GO² as a display controller:

1. Connect the display to be controlled to the same network as your **VIA GO²**.
2. Click **VIA Management > Display Controller** on the navigation pane.

The Display Controller page appears.

3. Click the **Activate Control** switch.
4. Enter the Display IP address and Display Control Port of the display screen to be controlled.
5. For Command 1, enter the command to send when someone first joins a meeting (for example, power ON the display).
6. For Command 2, enter the command you want the VIA to send when the last participant logs out of the meeting (for example, power OFF display).
7. Select **ASCII** or **HEX** to define command format accepted by your display.



Refer to the User Manual for your display for the correct format of the commands.

Configuring your **VIA GO²** as a display controller is complete.

Integrating Third Party Calendar

VIA GO² enables you to display scheduled meeting information on the main display home screen. VIA automatically retrieves information about meetings scheduled in the room where the VIA device resides. This feature is available for a room that has been added in Office 365[®] Admin Center, Microsoft Exchange[®] or in Google[®] Admin Console for G Suite[®].



Before configuring this feature in the VIA Gateway Management Pages, you must add the room in either Office 365 Admin Center, Microsoft Exchange or Google Admin Console for G Suite. See Configuring Third Party Apps for VIA Calendar Integration available for download at: [www.kramerav.com/downloads/VIA GO²](http://www.kramerav.com/downloads/VIA_GO2).

Integrating Office 365 Calendar

To integrate your Office 365 Calendar with VIA Calendar:

1. Click **Device Management** > **Calendar** on the navigation pane.
The Calendar page appears with Office 365 Basic Auth selected.
2. Select the **Activate Calendar** checkbox.
3. Under Account, select **Office 365 Basic Auth** from the Calendar Type drop down.
4. Enter the following for the room where this VIA gateway resides:
 - Username – Email address assigned to the room.
 - Password – Password associated with the room Username.
5. Select one of the following permission types for the user: **None**, **Impersonation**, **Delegate**.
6. Enter the email address for the resource calendar.
7. Click **Test Connection** to test if the details entered are correct.
8. Click **Save**.
Your Office 365 calendar is integrated with VIA Calendar.

Integrating Microsoft Exchange

When a resource mailbox (e.g. a meeting space) is created, the Exchange® administrator can synchronize with the mailbox to be none, an Impersonation or a Delegate.

To integrate Microsoft Exchange with VIA Calendar:

1. Click **Device Management** > **Calendar** on the navigation pane.
The Calendar page appears.
2. Select the **Activate Calendar** checkbox.
3. Select **MS Exchange** from the Calendar Type drop down.
The MS Exchange controls appear.
4. Enter the server URL.
5. Select the relevant version of Microsoft Exchange.
6. Enter the following for the meeting space where this VIA gateway resides:
 - Username – Email address assigned to the meeting space.
 - Password – Password associated with the meeting space Username.
7. Select one of the following permission types for the user: **None**, **Impersonation**, **Delegate**.
8. In Resource Calendar, enter a calendar name to identify the created calendar.



This field is enabled only after Impersonation or Delegate is selected for permission type.

8. Click **Test Connection** to test if the details entered are correct.

9. Click **Save**.
Microsoft Exchange is integrated with VIA Calendar.

Integrating Google Calendar

To integrate your Google Calendar with VIA Calendar:

1. Click **Device Management** > **Calendar** on the navigation pane.
The Calendar page appears.
2. Select the **Activate Calendar** checkbox.
3. Select **Google** from the Calendar Type drop down.
The Google Calendar controls appear.
Figure 6: Device Management > Calendar Page with Google Calendar Selected
4. Click **Click here to get code**.
Google sign in page appears.
5. Sign-in with the Google account where the shared space calendar was created.
6. Allow access to VIA-Calendar.
An integration code appears.
7. Copy the integration code from the Google sign in page and paste it into the Step 2 field on the VIA Calendar page.
8. Click **Get Calendar**.
9. In the Select the calendar field, select the calendar associated with the room.
10. Click Associate.
Your Google Calendar is integrated with VIA Calendar.

Configuring Digital Signage



For VIA devices sold before June 1st, 2019, Digital Signage is an optional feature available through separate licensing and pricing. Contact your local Kramer office for more details.

VIA GO² enables you to configure digital signage. The Digital Signage feature enables you to use VIA GO² to display dynamic content and information on the main display when there is no meeting in progress. Use a predefined template or create your own display layout with up to three frames of content that appear simultaneously. Then, schedule the content to run automatically at specific dates and times.

Configuring digital signage includes the following steps:

- [Creating and Uploading Digital Signage Media](#) on page [36](#).
- [Creating Custom Digital Signage Templates](#) on page [38](#).
- [Configuring a Digital Signage Campaign](#) on page [39](#).
- [Scheduling Digital Signage Campaign](#) on page [40](#).

Creating and Uploading Digital Signage Media

VIA GO² enables you to create a library of media content to be displayed through the digital signage feature. The types of media that can be displayed are:

- URL – Live web page.
- Scrolling Text – Custom text message that scroll across the screen.
- Image – Static image (allowed file extensions: jpg, jpeg, bmp, gif, png).
- Video (allowed file extensions: avi, mpeg, wmv, mpg, mov, vob, mkv, mp4, m4v).
- RSS feed –Live RSS feed.

To create and upload digital signage media:

1. Click **Digital Signage > Manage Content** on the navigation pane.

The Manage Content page appears.

2. Create and upload media, as required:
 - [Creating Scrolling Text](#) on page [36](#).
 - [Adding RSS Feed](#) on page [37](#).
 - [Adding Web URL](#) on page [37](#).
 - [Uploading Media Files](#) on page [38](#)
 - [Adding Fonts to Digital Signage](#) on page [38](#).

Creating Scrolling Text

To create scrolling text:

1. On the Manage Content page, click **Add Content**.
The Add Content pane appears with the Scroller tab open.
2. Type the text to be displayed in the box.
3. Type a name for the scroller in the Scroll Name text box.
4. Set the scroll speed.



Select **Zero** for speed to create a static text display that does not scroll.

5. Set the font parameters.



To add a font, click **Upload Font** or see [Adding Fonts to Digital Signage](#) on page [38](#).



The following variables can be entered into the text field:

- #airplayname# – Displays the airplay name.
- #roomname# – Displays the room name/code for joining into the meeting.
- #appass# – Displays the Access Point password.
- #apname# – Displays the Access Point name.
- #ipaddress1# – Displays the IP address for the primary network.
- #ipaddress2# – Displays the IP address for the second network, if in use.

6. Set the background color.

7. Click **Create**.

The Scroller is created and added to the Existing Media table.

Adding RSS Feed

To add an RSS feed:

1. On the Manage Content page, click **Add Content**.

The Add Content pane appears with the Scroller tab open.

2. Click **RSS**.

The RSS tab appears.

3. Enter the RSS feed URL address.

4. Click **Get tags** and select the required tag from the Select a tag drop-down list.

5. In the RSS Name field, enter a name for the RSS feed that will appear in the Existing Media table.

6. Under options, select the speed, display style, font settings and background color for the RSS feed.

7. Click **Create**.

The new RSS feed is added and appears in the Existing Media table.

Adding Web URL

Add the URL of an existing web page or use a third-party solution (for example, Google Slides) to publish a presentation to the web and add the URL of the presentation.

To add a web url for digital signage:

1. On the Manage Content page, click **Add Content**.

The Add Content pane appears with the Scroller tab open.

2. Click **Web URL**.

The Web URL tab appears.

3. Select the **Auto Refresh** checkbox to display a URL with dynamic content

OR

Clear the **Auto Refresh** checkbox to display a URL as a static page.

4. Type the URL address and File Name and click **Create**.
The new URL is added and appears in the Existing Media table.

Uploading Media Files

To upload media files:

1. On the Manage Content page, click **Add Content**.
The Add Content pane appears with the Scroller tab open.
2. Click **Media**.
The RSS tab appears.
3. Click **Browse File**.
A file browser appears.
4. Select an image or video file and click **Upload**.
The file is added and appears in the Existing Media table.

Adding Fonts to Digital Signage

To add new fonts to Digital Signage:

1. Click **Digital Signage > DSS Management** on the navigation pane.
The DSS Management page appears with the License Management tab open.
2. Click **Font Management**.
The Font Management tab appears.
3. Click **Browse File**.
A file browser appears.
4. Open the relevant font file and click **Upload**.
The new font is installed on **VIA GO²** and can be used for Digital Signage.

Creating Custom Digital Signage Templates

Templates dictate the layout of the digital signage content. Up to 3 frames of content can be displayed at once. **VIA GO²** enables you to use predefined templates and to create custom templates.

To create a custom digital signage template:

1. Click **Digital Signage > Template Manager** on the navigation pane.
The Template Manager page appears with Custom Templates tab open.



The Pre-Defined Templates tab explains all the pre-defined templates that are available when you create a campaign

2. Click **Custom Templates**.
The Custom Templates tab appears.
3. Click **Add Template**.

The Add Template pane appears.

4. Type a name for the new template in the Template Name text box.
5. Click and drag one of the frames into preview box.
The frame parameters for the frame appear below the preview.
6. Click and drag the box to move and resize it.
7. Select the **Audio** checkbox to play audio from the selected frame.



Only one frame can include audio.

8. Repeat steps 5–9 to add up to two more frames.



The layering order of the frames, from bottom to top is Frame 1, Frame 2, Frame 3.

9. Click **Save**.

The new template is added and appears in the Saved Templates table on the Custom Templates tab.



Click the Preview icon for a template to see a preview.



Click the **Edit** icon to open the template builder screen and edit the selected template.

Templates that are In Use (i.e. they have been used to configure a campaign (see [Configuring a Digital Signage Campaign](#) on page 39) cannot be edited.



Click the **Delete** icon to delete the selected template.

Configuring a Digital Signage Campaign

A Digital Signage Campaign defines what is displayed in each frame of a digital signage template layout.

To configure a digital signage campaign:

1. Click **Digital Signage > Campaign Editor** on the navigation pane.

The Create Campaign page appears.

2. Click **Add Campaign**.

The Campaign Editor appears.

3. Click a System or Custom Template.

The template appears in the preview box.

4. Click and drag one or more elements from the Content List into each frame.

The active frame turns blue and a list of the content items appears below the preview.

5. Set a Playlength for relevant items of content in the frame.



Videos other content that have a specific time length do not need to be set.

6. Click **Save**.

A message appears.

7. Enter a name for your Campaign and click **Ok**.

The Campaign is configured, and it appears on the Create Campaign page.

Scheduling Digital Signage Campaign

VIA GO² enables you to schedule when a digital signage campaign is displayed.

To schedule a digital signage campaign:

1. Click **Digital Signage > Schedule Campaign** on the navigation pane.

The Schedule Campaign page appears.

2. Click **Add Schedule**.

The Scheduling pane appears.

3. Select a Campaign to schedule.
4. Set a start date, end date, and hours.
5. Enter a name for the Campaign.
6. Click **Schedule**.

The Campaign is scheduled, and it appears on the Schedule Campaign page.

Maintaining Your VIA Unit

VIA GO² enables you to maintain your VIA unit by performing the following:

- [Viewing and Searching System Activity Logs](#) on page [40](#)
- [Updating Firmware](#) on page [41](#).
- [Activating VIA Gateway License](#) on page [42](#).
- [Resetting Default Settings](#) on page [42](#).
- [Running Setup Wizard](#) on page [42](#).

Viewing and Searching System Activity Logs

VIA GO² embedded web pages provide a log of system activities such as logins, presentation and VIA features usage to aid in diagnosing a problem or tracking participant usage.



To activate system activity logs, see [System](#) on page [26](#).

There are two types of system logs available for viewing and search:

- Gateway Activity Log – Shows activity of the meeting participants.
- Webadmin Activity Log – Shows activity of the Gateway and Gateway Settings

embedded web pages.

To view and search the system activity logs:

1. Click **Reports > Webadmin Activity Log / Gateway Activity Log** on the navigation pane.
The Webadmin Activity Log / Gateway Activity Log page appears.
2. Select the Start Date and the End Date to define the date range of log entries to be displayed.
3. Enter a search term and press the Enter key.
The filtered search results appear in the table at the bottom of the page.



Click **Export to PDF** or **Export to CSV** to save a file of the log table on your computer.

Updating Firmware

VIA GO² enables you to update your VIA GO² firmware.



If you are running a firmware version lower than 2.3, please install the 2.3.0418.960 release before updating your device to the latest release. In this case, use **ONLY** the .zip file available for download from our technical support web page: www.kramerav.com/support/downloads.asp.



The upload process and then the unit reboot may take a few minutes.

To update your VIA GO² firmware:

1. Click **Utility > Update Firmware** on the navigation pane.
The Update Firmware page appears.
2. When using an update file saved on your computer:
 - a. Click **Browse File**.
A file browser appears.
 - b. Select the relevant firmware update file.
 - c. Click **Upload**.
The new firmware is uploaded to the unit and the firmware is updated.

When using an update file on the website, and you have an internet connection:

- a. Click **Check for Update**.
A message appears with information about an available update.



Check for Updates is also available on the System Information Page.

- b. If an update is available, confirm the download.
The new firmware is downloaded to your computer.
- c. Click **Browse File**.
A file browser appears.
- d. Select the relevant firmware update file.

- e. Click **Upload**.

The new firmware is uploaded to the unit, the FW is updated and the unit reboots.



To verify the update, view the current firmware version on the Dashboard page of the Gateway Management pages or on the upper right corner of the user dashboard Participants tab.

Activating VIA Gateway License

VIA GO² enables you to upload and activate your VIA GO² license.

To upload your VIA GO² license:

1. Select **UTILITY > VIA License** on the navigation pane.

The VIA License page appears.

2. Click **Browse File**.

A file browser opens.

3. Select the relevant license file.

4. Click **Upload**.

The license is installed on VIA GO² and license information appears at the bottom of the page.



If a Digital License is already installed on your device, the name of the license appears on the bottom of the page.

Resetting Default Settings

VIA GO² enables you to reset VIA GO² to factory defaults.



Resetting Calendar Settings removes the calendar settings from the unit and credentials will be required to renew synchronization to your calendar.

To reset default settings:

1. Click **Utility > Maintenance** on the navigation pane.

The Maintenance page appears.

2. Select the default configurations you would like to reset or click **Select All** to select all settings.

3. Click **Apply**.

Selected settings are reset.

Running Setup Wizard

VIA GO² enables you to run the Setup Wizard on the next reboot of the VIA GO² unit.

To run the setup wizard:

1. Click **Utility > Maintenance** on the navigation pane.

The Maintenance page appears.

2. Select the **Show setup wizard on next reboot** checkbox.
3. Click **Apply**.
The setup wizard runs on the next reboot.

For Web Administrator: Configuring Settings – Gateway Dashboard

VIA GO² enables users with Web Administrator access to configure LAN settings and access system controls from the gateway dashboard.

Logging in to Gateway Dashboard Settings

The gateway dashboard Settings can be accessed by connecting a mouse and keyboard directly to the VIA gateway unit (see [For Installer: Connecting VIA GO²](#) on page 8).

To log in to the Gateway Dashboard Settings:

1. Click the VIA icon in the lower left of the main display.
The gateway dashboard appears.
2. Click **Settings**.
The login window appears.
3. Type an administrator user name and password (default user name = su, default password = supass).

The Settings screen appears with the LAN Settings tab open.

Changing LAN Settings

VIA GO² enables you to change the IP address, DNS server and default gateway of your VIA GO² unit.



The default IP setting is DHCP that assigns an automatic IP address to your unit. This enables easy plug and play setup when connecting your VIA GO² to the network. The following explains how to change a static IP address.



When changing these settings, make sure they are correct. Incorrect values can cause a loss of communication.

To change the LAN settings:

1. On the gateway dashboard Settings Screen, under IP Configuration, select **Static**.
2. Enter, as required, the Host Name, IP Address, Subnet Mask, Default Gateway, DNS Server.
3. Click **Apply**.
4. Click **OK** in the Confirmation Message.
The system reboots with the new settings.

Accessing System Controls

VIA GO² enables you to access VIA GO² operating system controls such as audio settings, display settings, and system health. You can also view log files and activate your VIA GO² unit.



The log folder is only available if system logging is activated (see [Viewing and Searching System Activity Logs](#) on page [40](#)).



The VIA GO² unit is pre-activated by Kramer. In case your license has been revoked, you can activate it here.

To access system controls:

1. On the Gateway Dashboard Settings Screen, click **System Controls**.
The System Controls tab appears.
2. Click the required icon.

For User: Running Kramer VIA App

Kramer VIA app enables you to use VIA GO² for collaborative meetings. Before moderating or joining a meeting, run the Kramer VIA app on your device using one of the following methods:

- [Running Kramer VIA App for PC and Mac](#) on page [46](#).
- [Running Kramer VIA App for Tablets & Smartphones](#) on page [46](#).
- [Running Kramer VIA App from a Web Browser](#) on page [47](#).
- [Running Kramer VIA App Using an Installation File](#) on page [47](#).



Participants using an Apple device can mirror their screen on the main display using the Apple AirPlay service without running the Kramer VIA app (see [Mirroring Apple Laptops and iPhones Using iOS/OS X Airplay Service](#) on page [54](#)).

Running Kramer VIA App for PC and Mac

To run Kramer VIA, for PC and Mac computers:

1. Open your Web browser and enter the IP address for your VIA GO² unit.
The VIA Welcome page appears.
2. Click one of the following two options:
 - **Run VIA** – Downloads a file that runs Kramer VIA virtually, without installing it on your computer.
Once downloaded, locate the file on your computer (under “Downloads”) and click it to launch.
The VIA GO² join screen appears.
 - **Install VIA** – installs Kramer VIA on your computer. After the .exe file is downloaded to your computer, a confirmation message appears. Click **Yes** and follow the Setup Wizard instructions.
The Kramer VIA app is saved to the KRAMER folder on your C:/ProgramFiles directory drive by default and a desktop shortcut is created for easy access.
However, you can select a different target folder in the Setup Wizard.

Running Kramer VIA App for Tablets & Smartphones

To run Kramer VIA for tablets and smartphones:

- Download Kramer VIA app from the App Store (iOS) or Google Play (Android).

Running Kramer VIA App from a Web Browser

You can run **Kramer VIA** app directly from a Chromebook, Chrome or FireFox web browser, without downloading any app to your device. .

To join a meeting locally using Chromebooks, Chrome, or Firefox web browser:

1. Navigate to the **VIA GO²** IP address with your browser.
The Gateway Management Pages Welcome page appears.
2. Click **Join through browser**.
The VIA login page appears.
3. Enter your screen nick name and click **Login**.
You are logged into the meeting. The VIA dashboard appears on the left side of the page.

Running Kramer VIA App Using an Installation File

For easy deployment and installation of **Kramer VIA** app on participant devices, IT managers can use the msi file (Windows) or dmg file (Apple) available at:

[www.kramerav.com/product/VIA GO²](http://www.kramerav.com/product/VIA_GO²)

For User: Participating in a VIA Meeting

This section explains how to participate in a collaborative meeting using **VIA GO²** and your personal device.

VIA GO² enables you to do the following:

- [Joining a VIA Meeting](#) on page [48](#).
- [Mirroring Your Device Screen](#) on page [52](#).

Joining a VIA Meeting

Participants can join (log into) a VIA meeting in the following ways:

- [Joining a VIA Meeting Manually](#) on page [48](#).
- [Joining a VIA Meeting using QR Code](#) on page [50](#).
- [Joining a VIA Meeting Using a VIA Pad](#) on page [51](#).
- [Joining a VIA Meeting Using a VIA NFC Tag for Android](#) on page [51](#).

Joining a VIA Meeting Manually

VIA GO² enables you to manually enter credentials for joining a VIA meeting.

To join a VIA meeting manually:

1. Connect your device to the same network that **VIA GO²** is connected to.
2. Run the **Kramer VIA** app.
The Connect to a VIA window appears.
3. Start typing the name or the IP address of the VIA meeting space to which you want to connect.

The Meeting Spaces list appears.



If the relevant meeting space does not appear on the list, enter the name and click **Join**.



To add a meeting space to your favorites, click the star next to the space.



One of the following statuses may appear next to a meeting space on the list:

- Room Free for hh:mm minutes – No user is logged in and a meeting will start after the displayed amount of time.
- Available – No user is logged in, broadcast is not enabled, or Calendar is not configured for **VIA GO²**.
- In Use – A user is logged in or a meeting is in progress (when Calendar is configured).
- In Use. Reserved for <hh:mm> minutes – A meeting is in progress and will end after the displayed amount of time.

4. Click **Join** next to the meeting that you want to join.

The Join a Meeting window appears.

5. In the Nick Name field, enter a nick name (username) for your device (it can be any combination of letters and numbers). This is the name that appears on the main display when you collaborate.

6. In the Password field, enter the room Code, as it appears on the main display.



The Room Code can only be seen by those present in the meeting space and it changes regularly (see [Formatting Room Code](#) on page 21). These are security features that ensure that only those present in the room can participate in the presentation.



You may be required to type a user name and password if Databased Moderator mode is activated (see [Moderator Mode](#) on page 28). For more information, ask your meeting Web Administrator.

7. Click **Join**.

You are logged into the VIA meeting.

The VIA User Dashboard (and taskbar icon for laptops) appears on your device screen.

The User Dashboard includes:

- Share App (see [Mirroring an App from Your Device](#) on page 53)
- Share Screen (see [Mirroring Device Screen](#) on page 53)
- Tap to Present (see [Mirroring Device Screen](#) on page 53)
- Show Options – Opens the Features and Participants tabs.
- Volume – Controls the **VIA GO²** audio output volume.

Joining a VIA Meeting using QR Code

VIA GO² enables you to use your mobile device to scan a QR code that appears on the main display to join a VIA meeting.





The following instructions are for iOS and Android mobile device users.

To join a VIA Meeting using the QR Code:

1. Connect your device to the same network as the VIA GO² and run the **Kramer VIA** app on your device.
The **Kramer VIA** Meeting Spaces screen appears.
2. On the toolbar at the bottom of the screen, tap **Scan**.
A capture screen appears on your device.
3. Scan the QR code that appears on the main display.
You are automatically logged in to the VIA meeting and the Kramer VIA dashboard appears.

Joining a VIA Meeting Using a VIA Pad

VIA GO² you to join a VIA meeting using a VIA Pad.

-  Make sure that your **VIA Pad** has been paired with your **VIA GO²** unit before using it (see [Configuring VIA Pad Settings](#) on page 16).
-  The following instructions are for Windows and Mac OS users.

To join a meeting using a VIA Pad:

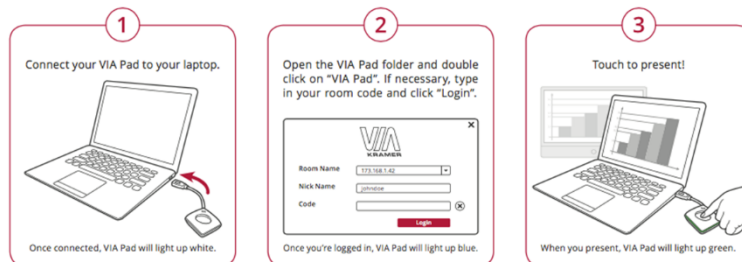

1. Connect your **VIA Pad** to a USB connector on your laptop.
2. Open the **VIA Pad** folder and double-click the **VIA Pad** app. The **Kramer VIA** login window appears.
3. If necessary, type in your room code.
4. Click **Join**.
Your **VIA Pad** lights blue when ready.
The VIA Dashboard and taskbar appear on your device screen.
5. Use **VIA Pad** to present:
 - Press once – Starts presenting or stops presenting your screen on the main display. When you are presenting, the **VIA Pad** LED banner lights green. When you stop presenting, the LED banner lights blue.
 - Press twice while presenting – Freezes or unfreezes your screen. When your screen is frozen, the **VIA Pad** LED banner flashes green.
 - Long press – Displays your screen in full screen mode on the main display, displacing any other participant screen.

Joining a VIA Meeting Using a VIA NFC Tag for Android

VIA GO² enables you to join a VIA meeting using a VIA NFC Tag with an Android device.

Writing an NFC Tag

To write an NFC tag:

1. Download the free VIA NFC Writer file from the Kramer Website (www.kramerav.com/support/download.asp?f=50898&pname=via%20nfc%20writer) and install it on your Android device.

2. Open VIA NFC Writer.
The Home screen appears.
3. Type the room name that you want to program and click **Write tag**.
4. When prompted, touch the Android device to the writable tag.
A message appears, confirming that the tag was successfully written.

Joining Using NFC Tag



The **Kramer VIA** app must be installed on your device join a meeting using the NFC tag (see [For User: Running Kramer VIA App](#) on page [46](#)).

To join a VIA meeting using the NFC tag:

1. Enable the NFC feature on your Android device.
2. Touch the Android device to the tag.
You are automatically logged into **VIA GO²**. The room code is bypassed.
The VIA Dashboard and taskbar appear on your device screen.

Mirroring Your Device Screen

VIA GO² enables you to mirror your device screen on the main display using either **Kramer VIA** app, Apple AirPlay Service (when using an Apple device, or Miracast (when using a Windows 10 laptop or compatible Android device).

Mirror your device screen on the main display using one of the following methods:

- [Mirroring Windows Laptops and Android Mobile Devices Using Kramer VIA](#) on page [52](#).
- [Mirroring Apple Laptops and iPhones Using iOS/OS X Airplay Service](#) on page [54](#).

You can also use the following features when mirroring via **Kramer VIA** app:

- [Mirroring with Extended Desktop](#) on page [55](#).
- [Mirroring Without Being Interrupted](#) on page [55](#).

Mirroring Windows Laptops and Android Mobile Devices Using Kramer VIA

Windows laptops and Android mobile devices can use **Kramer VIA** app to mirror their screen.



Android mirroring does not support audio. Audio is heard from your device and not from the output of the VIA device.

You can mirror your Windows laptop and Android device in the following ways:

- [Mirroring Device Screen](#) on page [53](#).
- [Mirroring an App from Your Device](#) on page [53](#).

Mirroring Device Screen

VIA GO² enables you to mirror your entire device screen on the main display.

To mirror your Windows laptop or Android device screen using Kramer VIA:

1. Connect your laptop or Android device to the network to which your VIA GO² is connected.
2. Join the VIA meeting (see [Joining a VIA Meeting](#) on page 48).
The VIA dashboard appears.
3. Under **Tap to Present**, click the green button.
4. For Share Screen, select **1** (your main screen) or **2** (your secondary screen).
Your screen is mirrored on the main display.



The secondary screen option is available only for Windows laptops.



Minimize **Kramer VIA** app by clicking the minimize icon on the window or by clicking the Home button of your Android device and open any content on your device to share it on the main display.



To stop mirroring your screen, re-open **Kramer VIA** app and click the red button under **Stop Presenting**.

Mirroring an App from Your Device

VIA GO² enables you to mirror only one app that is open on your device. The rest of the content on your screen is not mirrored.



Audio is currently not supported for this feature.

To mirror only one app from your device:

1. On the VIA app dashboard, click **Share App**.
The Choose window appears.
2. Select the application window to share and click **Share**.
Only the selected app is shared on the VIA main display.



To stop mirroring the app, on **Kramer VIA** app, click **Stop Presenting**.

Mirroring Apple Laptops and iPhones Using iOS/OS X Airplay Service

All participants in a meeting using an Apple device can mirror their screen on the main display using the Apple AirPlay service. No application is required to activate this mode. However, an administrator must enable the iOS mirroring feature in the **VIA GO²** Gateway Management pages (see [Presentation](#) on page [27](#)).

Minimum requirements for mirroring using Airplay services are:

- iPhone or iPad/Mini iPad – Minimum version iOS 10 (iOS 12 or higher is recommended).
- Mac Books and Apple Computers – Minimum version OS X 10.11 (Mojave or higher is recommended).



AirPlay discovery relies on Bonjour (mDNS). For more information see VIA IT Deployment Guide, available for download at:

www.kramerav.com/downloads/VIA GO².

To mirror your screen using AirPlay Services:

1. Connect your Apple device to the network that **VIA GO²** is connected to.
2. For iPhone or iPad/Mini iPad: Swipe from the upper right corner to reveal the Control Center and click **Screen Mirroring**.

For Mac Books and Apple Computers: Click the AirPlay icon on the Apple Menu Bar, located in the top right corner of the screen, near the clock.

The Screen Mirroring list appears.

3. Select **VIA GO²**'s AirPlay device name (default = **VIA_AirMirror_XXXX**, where XXXX is a random combination of letters and numbers).
If the room code is enabled, a message appears asking you to enter the code.
4. Type the code that appears on the **VIA GO²** main display (if activated).
Mirroring starts, and your screen appears on the main display.

To disconnect iPhone or iPad/Mini iPad and stop mirroring:

1. Swipe from the upper right corner to reveal the Control Center.
2. Click **Stop Mirroring**.
Mirroring stops.

Mirroring with Extended Desktop

VIA GO² enables users to use the main display as an extension of their device desktop to present content. The user's primary screen is not mirrored, allowing the user to keep the content on their laptop display private while mirroring.



This feature is available on Windows client laptops only, after installation of the required drivers. When using this feature for the first time, the system asks you to install the drivers. Please accept and follow the on-screen instructions. Once the drivers are installed, reboot your PC to enable the feature.



Mac users can use AirPlay to simulate the same behavior (see [Mirroring Apple Laptops and iPhones Using iOS/OS X Airplay Service](#) on page 54).

To mirror with the Extended Desktop feature:

- On the Kramer VIA app dashboard, click the share screen icon with a **2**.
An extension of your device desktop appears on the VIA main display.
Drag content to the left and beyond your primary screen to show it on the main display.



You can change the relative positioning of the two displays in your device Control Panel under Screen Resolution.

Mirroring Without Being Interrupted

VIA GO² enables you to prevent others from mirroring their devices while you are using Kramer VIA app to mirror your device.



To use the Do Not Disturb feature, it must first be enabled by the Web Administrator using the Gateway Management Pages.

To mirror without being interrupted:

1. Become the meeting moderator (see [Becoming Meeting Moderator](#) on page 56).
2. On the VIA dashboard, click **Present**.

The Present button turns green, and you are presenting.

3. Click **Do Not Disturb**.

The icon turns white, and you enter Do Not Disturb mode.



You have full access to all features. The other participants see a modified user dashboard that only allows access to the Participants tab. Other icons, except View Main Display, are disabled.



Click **Do Not Disturb** to deactivate Do Not Disturb mode.

Accessing VIA GO² Files

VIA GO² enables you to open or download files that were saved to your VIA GO² internal memory.

To access VIA GO² files:

1. On the Dashboard, click **Features > Files**.
A dialog box appears.
2. Click **Download file from VIA**.
The VIA GO² file browser window appears on your device.
3. Click the download icon from the Actions column for the relevant file.
A file browser on your device opens.
4. Select the folder to which you want to download the file and click Open.
The file is downloaded from VIA GO² to your device.

Becoming Meeting Moderator

VIA GO² enables any authorized meeting participant to become a moderator. The moderator is notified when a meeting participant requests to present and can accept or reject the request.

•



Moderator Mode must be activated to enable becoming a Moderator during a meeting (see [Moderator Mode](#) on page 28).

To become the meeting moderator:

1. On the user dashboard, click **Show Options > Participants**.
The Participants tab appears.
2. Click **Moderator**.
The Moderator button turns green.
3. When Basic Moderator Mode is active, type the password and click **Apply**.
You are now the moderator.



To stop being moderator, click **Moderator**.
The Moderator button turns yellow.

Allowing a Participant to Mirror on Main Display

The moderator of a meeting must give permission to any meeting participant who wants to mirror their screen on the main display.

To allow a participant to mirror on the main display:

1. The participant clicks **Present**.
A presentation request window appears on the moderator's screen.

 A preview of the participant's screen is displayed in the window (when the request is from a MAC or Windows device) to help the moderator accept or deny the request:

2. The moderator clicks **Allow full screen**.
The participant's presentation appears on the main display.

 The moderator can present at any time without permission.

Technical Specifications

Ports	1 Ethernet	On an RJ-45 connector
	1 USB 3.0	On a female USB type-A connector
	1 USB 2.0	On a female USB type-A connector
Outputs	1 HDMI	On a female HDMI connector
Video	Max Resolution	4K@30Hz
General	Processor	Intel® Gemini Lake SOC
	Main Memory	4GB LPDDR4 (2400)
	Storage	32GB eMMC
	Networking	802.11 ac/b/g/n dual band Wireless LAN and Bluetooth 4.1
	Operating System	Linux
Power	Source	12V DC
	Consumption	2A
Enclosure	Cooling	
Environmental Conditions	Operating Temperature	0° to +40°C (32° to 104°F)
	Storage Temperature	-40° to +70°C (-40° to 158°F)
	Humidity	10% to 90%, RHL non-condensing
Accessories	Included	Power adapter
Regulatory Compliance	Safety	CE
Physical	Product Dimensions	7.00cm x 7.00cm x 3.34cm (2.76" x 2.76" x 1.31") W, D, H
	Product Weight	0.4kg (0.9lbs) approx.
	Shipping Dimensions	15.20cm x 12.00cm x 8.50cm (5.98" x 4.72" x 3.35") W, D, H
	Shipping Weight	0.9kg (2.0lbs) approx.
Specifications are subject to change without notice at www.kramerav.com		

VIA App Android Permissions

Permission Category	Description	How Used
Camera	Take pictures and videos.	Logging in through QRCode reader.
Contacts	Find accounts on the device.	Logging in to cloud storage apps like Google Drive, OneDrive, and Dropbox.
Network	<ul style="list-style-type: none"> • Full network access. • View WiFi connection. • View network connection. • Receive internet data. • Phone. 	Accessing the internet over WiFi or mobile data connection and accessing the WiFi name and status for logging in to VIA app
Location	<ul style="list-style-type: none"> • Access precise location only in the foreground. • Access approximate location (network-based) only in the foreground. 	Same as Network permissions. This is additional permission required in Android 9 and higher.
Storage	Read, modify, or delete the contents of your shared storage.	Acquiring and saving image, video, pdf, and other types of files from the device/SD Card.
Bluetooth network	<ul style="list-style-type: none"> • Access Bluetooth settings. • Pair with Bluetooth Devices. 	Enabling autofill Nick Name/ Username on the login page, if the device name API is not supported in Android phone.
NFC	Controlling NFC (Near Field Communication).	Logging in via NFC tag.
Power Settings	Prevent phone from sleeping	Preventing your device from going into sleep mode while using VIA App.

The warranty obligations of Kramer Electronics Inc. ("Kramer Electronics") for this product are limited to the terms set forth below:

What is Covered

This limited warranty covers defects in materials and workmanship in this product.

What is Not Covered

This limited warranty does not cover any damage, deterioration or malfunction resulting from any alteration, modification, improper or unreasonable use or maintenance, misuse, abuse, accident, neglect, exposure to excess moisture, fire, improper packing and shipping (such claims must be presented to the carrier), lightning, power surges, or other acts of nature. This limited warranty does not cover any damage, deterioration or malfunction resulting from the installation or removal of this product from any installation, any unauthorized tampering with this product, any repairs attempted by anyone unauthorized by Kramer Electronics to make such repairs, or any other cause which does not relate directly to a defect in materials and/or workmanship of this product. This limited warranty does not cover cartons, equipment enclosures, cables or accessories used in conjunction with this product. Without limiting any other exclusion herein, Kramer Electronics does not warrant that the product covered hereby, including, without limitation, the technology and/or integrated circuit(s) included in the product, will not become obsolete or that such items are or will remain compatible with any other product or technology with which the product may be used.

How Long this Coverage Lasts

The standard limited warranty for Kramer products is seven (7) years from the date of original purchase, with the following exceptions:

1. All Kramer VIA hardware products are covered by a standard three (3) year warranty for the VIA hardware and a standard three (3) year warranty for firmware and software updates; all Kramer VIA accessories, adapters, tags, and dongles are covered by a standard one (1) year warranty.
2. Kramer fiber optic cables, adapter-size fiber optic extenders, pluggable optical modules, active cables, cable retractors, ring mounted adapters, portable power chargers, Kramer speakers, and Kramer touch panels are all covered by a standard one (1) year warranty.
3. All Kramer Cobra products, all Kramer Calibre products, all Kramer Minicom digital signage products, all HighSecLabs products, all streaming, and all wireless products are covered by a standard three (3) year warranty.
4. All Sierra Video MultiViewers are covered by a standard five (5) year warranty.
5. Sierra switchers & control panels are covered by a standard seven (7) year warranty (excluding power supplies and fans that are covered for three (3) years).
6. K-Touch software is covered by a standard one (1) year warranty for software updates.
7. All Kramer passive cables are covered by a ten (10) year warranty.

Who is Covered

Only the original purchaser of this product is covered under this limited warranty. This limited warranty is not transferable to subsequent purchasers or owners of this product.

What Kramer Electronics Will Do

Kramer Electronics will, at its sole option, provide one of the following three remedies to whatever extent it shall deem necessary to satisfy a proper claim under this limited warranty:

1. Elect to repair or facilitate the repair of any defective parts within a reasonable period of time, free of any charge for the necessary parts and labor to complete the repair and restore this product to its proper operating condition. Kramer Electronics will also pay the shipping costs necessary to return this product once the repair is complete.
2. Replace this product with a direct replacement or with a similar product deemed by Kramer Electronics to perform substantially the same function as the original product. If a direct or similar replacement product is supplied, the original product's end warranty date remains unchanged and is transferred to the replacement product.
3. Issue a refund of the original purchase price less depreciation to be determined based on the age of the product at the time remedy is sought under this limited warranty.

What Kramer Electronics Will Not Do Under This Limited Warranty

If this product is returned to Kramer Electronics or the authorized dealer from which it was purchased or any other party authorized to repair Kramer Electronics products, this product must be insured during shipment, with the insurance and shipping charges prepaid by you. If this product is returned uninsured, you assume all risks of loss or damage during shipment. Kramer Electronics will not be responsible for any costs related to the removal or re-installation of this product from or into any installation. Kramer Electronics will not be responsible for any costs related to any setting up this product, any adjustment of user controls or any programming required for a specific installation of this product.

How to Obtain a Remedy Under This Limited Warranty

To obtain a remedy under this limited warranty, you must contact either the authorized Kramer Electronics reseller from whom you purchased this product or the Kramer Electronics office nearest you. For a list of authorized Kramer Electronics resellers and/or Kramer Electronics authorized service providers, visit our web site at www.kramerav.com or contact the Kramer Electronics office nearest you.

In order to pursue any remedy under this limited warranty, you must possess an original, dated receipt as proof of purchase from an authorized Kramer Electronics reseller. If this product is returned under this limited warranty, a return authorization number, obtained from Kramer Electronics, will be required (RMA number). You may also be directed to an authorized reseller or a person authorized by Kramer Electronics to repair the product.

If it is decided that this product should be returned directly to Kramer Electronics, this product should be properly packed, preferably in the original carton, for shipping. Cartons not bearing a return authorization number will be refused.

Limitation of Liability

THE MAXIMUM LIABILITY OF KRAMER ELECTRONICS UNDER THIS LIMITED WARRANTY SHALL NOT EXCEED THE ACTUAL PURCHASE PRICE PAID FOR THE PRODUCT. TO THE MAXIMUM EXTENT PERMITTED BY LAW, KRAMER ELECTRONICS IS NOT RESPONSIBLE FOR DIRECT, SPECIAL, INCIDENTAL OR CONSEQUENTIAL DAMAGES RESULTING FROM ANY BREACH OF WARRANTY OR CONDITION, OR UNDER ANY OTHER LEGAL THEORY. Some countries, districts or states do not allow the exclusion or limitation of relief, special, incidental, consequential or indirect damages, or the limitation of liability to specified amounts, so the above limitations or exclusions may not apply to you.

Exclusive Remedy

TO THE MAXIMUM EXTENT PERMITTED BY LAW, THIS LIMITED WARRANTY AND THE REMEDIES SET FORTH ABOVE ARE EXCLUSIVE AND IN LIEU OF ALL OTHER WARRANTIES, REMEDIES AND CONDITIONS, WHETHER ORAL OR WRITTEN, EXPRESS OR IMPLIED. TO THE MAXIMUM EXTENT PERMITTED BY LAW, KRAMER ELECTRONICS SPECIFICALLY DISCLAIMS ANY AND ALL IMPLIED WARRANTIES, INCLUDING, WITHOUT LIMITATION, WARRANTIES OF MERCHANTABILITY AND FITNESS FOR A PARTICULAR PURPOSE. IF KRAMER ELECTRONICS CANNOT LAWFULLY DISCLAIM OR EXCLUDE IMPLIED WARRANTIES UNDER APPLICABLE LAW, THEN ALL IMPLIED WARRANTIES COVERING THIS PRODUCT, INCLUDING WARRANTIES OF MERCHANTABILITY AND FITNESS FOR A PARTICULAR PURPOSE, SHALL APPLY TO THIS PRODUCT AS PROVIDED UNDER APPLICABLE LAW.

IF ANY PRODUCT TO WHICH THIS LIMITED WARRANTY APPLIES IS A "CONSUMER PRODUCT" UNDER THE MAGNUSON-MOSS WARRANTY ACT (15 U.S.C.A. §2301, ET SEQ.) OR OTHER APPLICABLE LAW, THE FOREGOING DISCLAIMER OF IMPLIED WARRANTIES SHALL NOT APPLY TO YOU, AND ALL IMPLIED WARRANTIES ON THIS PRODUCT, INCLUDING WARRANTIES OF MERCHANTABILITY AND FITNESS FOR THE PARTICULAR PURPOSE, SHALL APPLY AS PROVIDED UNDER APPLICABLE LAW.

Other Conditions

This limited warranty gives you specific legal rights, and you may have other rights which vary from country to country or state to state.

This limited warranty is void if (i) the label bearing the serial number of this product has been removed or defaced, (ii) the product is not distributed by Kramer Electronics or (iii) this product is not purchased from an authorized Kramer Electronics reseller. If you are unsure whether a reseller is an authorized Kramer Electronics reseller, visit our web site at www.kramerav.com or contact a Kramer Electronics office from the list at the end of this document.

Your rights under this limited warranty are not diminished if you do not complete and return the product registration form or complete and submit the online product registration form. Kramer Electronics thanks you for purchasing a Kramer Electronics product. We hope it will give you years of satisfaction.



P/N:



2900-301300

Rev:



3



SAFETY WARNING

Disconnect the unit from the power supply before opening and servicing

For the latest information on our products and a list of Kramer distributors, visit our Web site where updates to this user manual may be found.

We welcome your questions, comments, and feedback.

The terms HDMI, HDMI High-Definition Multimedia Interface, and the HDMI Logo are trademarks or registered trademarks of HDMI Licensing Administrator, Inc. All brand names, product names, and trademarks are the property of their respective owners.