

ANI-0108POE-AU

1x8 HDMI 18Gbps Splitter over CAT6 196ft/60M





SAFETY INFORMATION



1. To ensure the best results from this product, please read this manual and all other documentation before operating your equipment. Retain all documentation for future reference.
2. Follow all instructions printed on unit chassis for proper operation.
3. To reduce the risk of fire, do not spill water or other liquids into or on the unit, or operate the unit while standing in liquid.
4. Make sure power outlets conform to the power requirements listed on the back of the unit. Keep unit protected from rain, water and excessive moisture.
5. Do not attempt to clean the unit with chemical solvents or aerosol cleaners, as this may damage the unit. Dust with a clean dry cloth.
6. Do not use the unit if the electrical power cord is frayed or broken. The power supply cords should be routed so that they are not likely to be walked on or pinched by items placed upon or against them, paying particular attention to cords and plugs, convenience receptacles, and the point where they exit from the appliance.
7. Do not force switched or external connections in any way. They should all connect easily, without needing to be forced.
8. Always operate the unit with the AC ground wire connected to the electrical system ground. Precautions should be taken so that the means of grounding of a piece of equipment is not defeated.
9. AC voltage must be correct and the same as that printed on the rear of the unit. Damage caused by connection to improper AC voltage is not covered by any warranty.
10. Turn power off and disconnect unit from AC current before making connections.
11. Never hold a power switch in the "ON" position.
12. This unit should be installed in a cool dry place, away from sources of excessive heat, vibration, dust, moisture and cold. Do not use the unit near stoves, heat registers, radiators, or other heat producing devices.
13. Do not block fan intake or exhaust ports. Do not operate equipment on a surface or in an environment which may impede the normal flow of air around the unit, such as a bed, rug, carpet, or completely enclosed rack. If the unit is used in an extremely dusty or smoky environment, the unit should be periodically "blown free" of foreign dust and matter.
14. To reduce the risk of electric shock, do not remove the cover. There are no user serviceable parts inside. Refer all servicing to qualified service personnel. There are no user serviceable parts inside.
15. When moving the unit, disconnect input ports first, then remove the power cable; finally, disconnect the interconnecting cables to other devices.
16. Do not drive the inputs with a signal level greater than that required to drive equipment to full output.
17. The equipment power cord should be unplugged from the outlet when left unused for a long period of time.
18. Save the carton and packing material even if the equipment has arrived in good condition. Should you ever need to ship the unit, use only the original factory packing.
19. Service Information Equipment should be serviced by qualified service personnel when:
 - A. The power supply cord or the plug has been damaged.
 - B. Objects have fallen, or liquid has been spilled into the equipment.
 - C. The equipment has been exposed to rain.
 - D. The equipment does not appear to operate normally, or exhibits a marked change in performance.
 - E. The equipment has been dropped, or the enclosure damaged.

▶ CONTENTS

INTRODUCTION.....1
 PACKAGE CONTENTS1
 FEATURES2
 SPECIFICATIONS.....3
 OPERATION CONTROLS & FUNCTIONS4
 EDID MODES6
 ASCII COMMANDS7
 IR PIN DEFINITION10
 APPLICATION EXAMPLE11

DEAR CUSTOMER

Thank you for purchasing this product. For optimum performance and safety, please read these instructions carefully before connecting, operating or adjusting this product. Please keep this manual for future reference.

INTRODUCTION

The ANI-0108POE-AU 1x8 18Gbps HDMI Splitter can distribute (1) HDMI source signal to (8) display devices. The product supports (1) HDMI input, (1) HDMI loop output and (8) CAT outputs. It can extend the signal transmission distance up to 114ft/35M at the resolution of 4K2K@60Hz, 164ft/50M at 4K2K@30Hz, 196ft/60M at 1080P@60Hz via a single CAT6/6a/7 cable. The product supports up to 7.1CH HD audio pass-through. It supports audio extraction function (audio remains embedded on the HDMI/CAT cable) and advanced EDID management. This unit has a 3 year warranty.

PACKAGE CONTENTS

Before attempting to use this unit, please check the packaging and make sure the following items are contained in the shipping carton:

- ANI-0108POE-AU 1x8 18Gbps HDMI Splitter
- (8) CAT Receivers
- IR Blaster Cable (5 ft / 1.5M)
- USB -to- USB Micro-B cable
- (8) 20K~60KHz IR Receiver Cable (5 ft / 1.5M)
- 12V/2.5A DC Locking Power Adapter
- Users Guide

SAFETY PRECAUTIONS

Please read all instructions before attempting to unpack, install or operate this equipment and before connecting the power supply. Please keep the following in mind as you unpack and install this equipment:

- Always follow basic safety precautions to reduce the risk of fire, electrical shock and injury to persons.
- To prevent fire or shock hazard, do not expose the unit to rain, moisture or install this product near water.
- Never spill liquid of any kind on or into this product.
- Never push an object of any kind into this product through any openings or empty slots in the unit, as you may damage parts inside the unit.
- Do not attach the power supply cabling to building surfaces.
- Use only the supplied power supply unit (PSU). Do not use the PSU if it is damaged.
- Do not allow anything to rest on the power cabling or allow any weight to be placed upon it or any person walk on it.
- To protect the unit from overheating, do not block any vents or openings in the unit housing that provide ventilation and allow for sufficient space for air to circulate around the unit.

DISCLAIMERS

The information in this manual has been carefully checked and is believed to be accurate. We assume no responsibility for any infringements of patents or other rights of third parties which may result from its use.

We assume no responsibility for any inaccuracies that may be contained in this document. We make no commitment to update or to keep current the information contained in this document.

We reserve the right to make improvements to this document and/or product at any time and without notice.

COPYRIGHT NOTICE

No part of this document may be reproduced, transmitted, transcribed, stored in a retrieval system, or any of its part translated into any language or computer file, in any form or by any means — electronic, mechanical, magnetic, optical, chemical, manual, or otherwise — without the express written permission and consent.

© Copyright 2020. All Rights Reserved.
 Version 1.4 NOV 2020

TRADEMARK ACKNOWLEDGMENTS

All products or service names mentioned in this document may be trademarks of the companies with which they are associated.

FEATURES

- HDMI 2.0, HDCP 2.2 / 1.x and DVI 1.0 compliant
- Supports 18Gbps video bandwidth
- Supports video resolution up to 4K2K@50/60Hz 4:4:4
- Supports 3D, HDR, HDR10+, HLG and Dolby vision
- Supports up to 7.1CH HD audio pass-through
- Supports digital and analog audio de-embedded output
- Extends the signal transmission distance up to 114ft/35M at the resolution of 4K2K@60Hz, 164ft/50M at 4K2K@30Hz, 196ft/60M at 1080P@60Hz via a single CAT6/6a/7 cable
- Supports (1) HDMI input, (1) HDMI loop output and (8) CAT outputs
- Supports one-way IR control signal pass-through
- Advanced EDID management
- Supports one-way PoC function (only from transmitter to receiver)
- Compact design for easy and flexible installation

NOTES

For the best results, it is suggested you use pure copper and not copper clad aluminum and use solid, riser rated cable and not stranded cable. Stranded cable has ~20% higher signal attenuation than solid, so its runs need to be shorter.

Contiguous cable runs are preferred. The use of network punch down into patch panels and keystone jacks adds attenuation and runs need to be shorter.

The use of EZ-45® connectors are not recommended as the cable extends outside the end of the RJ45 connector and can act as an inductor of noise.

SPECIFICATIONS

- **HDMI Compliance:** HDMI 2.0
- **HDCP Compliance:** HDCP 2.2/1.x
- **Video Bandwidth:** 594MHz/18Gbps
- **Video Resolution:** Up to 4K2K@50/60Hz 4:4:4
- **Color Depth:**
 - 8-bit, 10-bit, 12-bit (1080p@60Hz)
 - 8-bit (4K2K@60Hz YUV4:4:4)
 - 8-bit, 10-bit, 12-bit (4K2K@60Hz YCbCr 4:2:2/4:2:0)
- **Color Space:** RGB, YCbCr 4:4:4 / 4:2:2. YUV 4:2:0
- **HDR:** Support HDR10, HDR10+, HLG, Dolby vision
- **HDMI Audio Formats:** LPCM, Dolby Digital/Plus/EX, Dolby True HD, DTS, DTS-EX, DTS-96/24, DTS High Res, DTS-HD Master Audio, DSD
- **Coaxial Audio Formats:** LPCM2.0, LPCM5.1, Dolby Digital2/5.1CH
- **Analog Audio Formats:** PCM 2.0
- **ESD Protection Human Body Model:**
 - ±8kV (air-gap discharge)
 - ±4kV (contact discharge)
- **Input:** HDMI Type A (19-pin female)
- **Output:**
 - HDMI Type A (19-pin female)
 - (8) CAT OUT [RJ45, 8-pin female]
 - Coaxial Audio OUT [RCA]
 - L/R Audio OUT [3.5mm Stereo Mini-jack]
- **Control:**
 - SERVICE ((2) USB MICRO-B; Used for firmware update and serial port com)
 - EDID DIP switch [5-pin]
 - IR OUT [3.5mm Stereo Mini-jack]
- **Housing:** Metal Enclosure
- **Silkscreen Color:** Black
- **Dimensions (WxDxH):**
 - Transmitter: 11.8 x 3.9 x 1.1 in (300x100x28mm)
 - Receiver: 3.5 x 2.4 x .7 in (88x61x18mm)
- **Weight:** Transmitter: 1.81 lbs/823g / Receiver: .34lbs/155g
- **Power Supply:** Input: AC100 - 240V 50/60Hz, Output: DC 12V/2.5A (US/EU standards, CE/FCC/UL certified)
- **Power Consumption:** 25.44W
- **Operation Temperature:** 0°C ~ 40°C / 32°F ~ 104°F
- **Storage Temperature:** -20°C ~ 60°C / -4°F ~ 140°F
- **Relative Humidity:** 20~90% RH (non-condensing)

As product improvements are continuous, specifications are subject to change without notice.

TRANSMITTER

FRONT PANEL

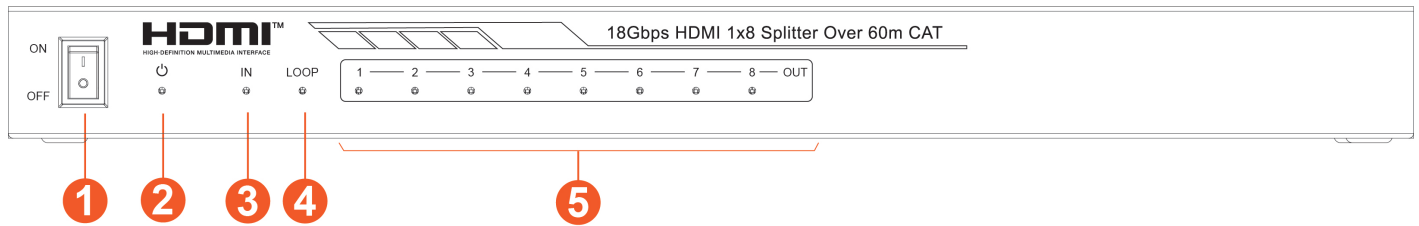

- 1 **POWER SWITCH:** Press this switch to power on/off the device.
- 2 **POWER LED:** When the device is powered on, the red power LED will be on.
- 3 **IN LED:** When the HDMI IN port connects an active source device, the green LED will be on.
- 4 **LOOP LED:** When the HDMI LOOP OUT port connects an active display device, the green LED will be on.
- 5 **OUT LED (1~8):** When the HDMI OUT port connects an active display device, the corresponding green OUT LED will be on.

BACK PANEL

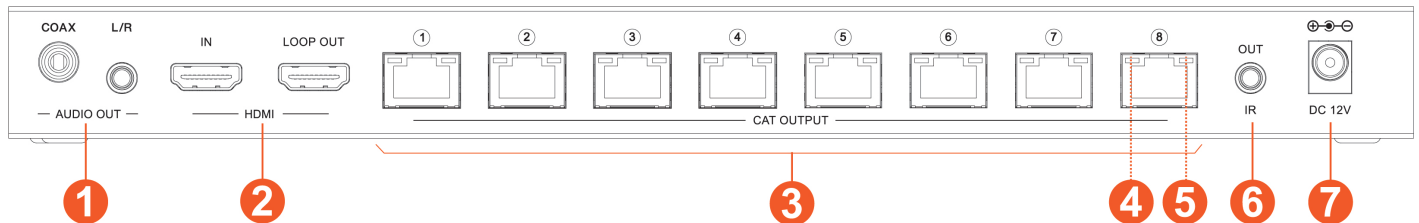

- 1 **AUDIO OUT (COAX, L/R):** Coaxial/analog audio output port, connect to amplifier or speaker.
- 2 **HDMI PORT:**
 - IN:** HDMI input port, connect to HDMI source device such as DVD or set-top box with an HDMI cable.
 - LOOP OUT:** HDMI loop output port, connect to the HDMI display device such as TV or Monitor with an HDMI cable.
- 3 **CAT OUTPUT PORT (1~8):** Connect to the CAT IN port of the CAT receiver with a CAT cable.
- 4 **LINK SIGNAL INDICATOR LAMP (GREEN):**
 - Illuminate:** Transmitter and receiver are connected.
 - Dark:** Transmitter and receiver are not connected.
- 5 **DATA SIGNAL INDICATOR LAMP (ORANGE):**
 - Illuminate:** There is signal transmission between the transmitter and the receiver.
 - Dark:** No signal transmission.
- 6 **IR OUT:** Connect the IR Blaster cable to transmit IR signal from the CAT receiver.
- 7 **DC 12V:** Plug the DC 12V power supply into the unit and connect the adaptor to an AC outlet.
(Note: The transmitter can power the receiver via a CAT cable.)

TRANSMITTER

SIDE PANEL

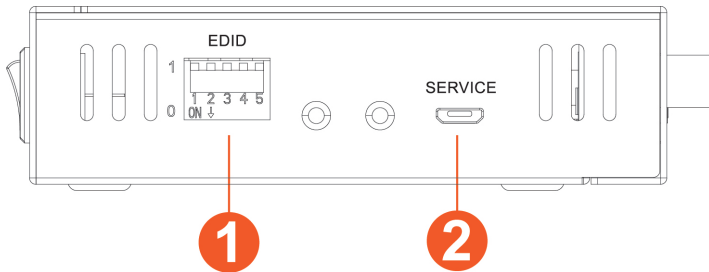

- ① **EDID DIP SWITCH:** Used to set EDID mode. Please refer to Section “6. EDID Mode” for details.
- ② **SERVICE PORT:** (2) USB MICRO-B; Used for firmware update and serial port com. Please refer to “7. ASCII Commands”.

CAT RECEIVER

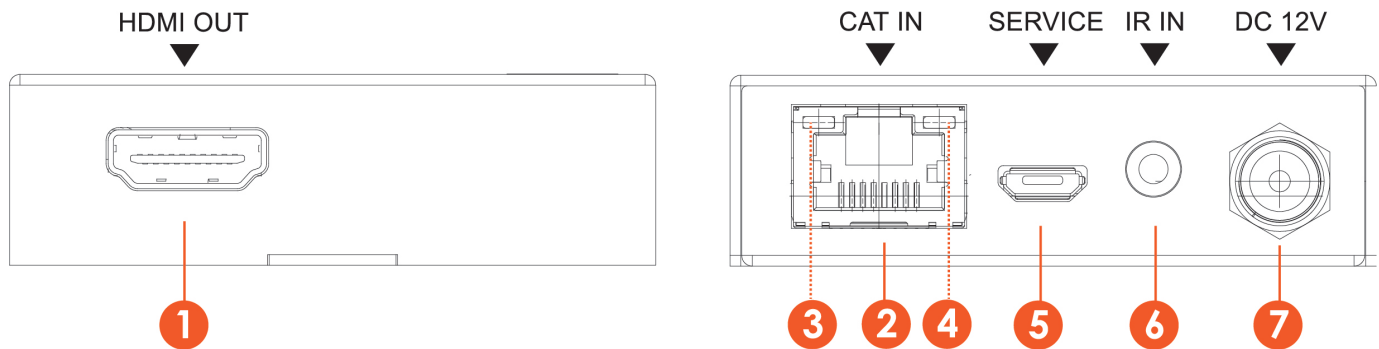

- ① **HDMI OUT:** HDMI output port, connect to HDMI display device such as TV or Projector with an HDMI cable.
- ② **CAT IN:** Connect to the CAT OUTPUT port on the transmitter with a CAT cable.
- ③ **POWER INDICATOR LAMP (GREEN):** When the receiver is powered on, the power indicator lamp will be on.
- ④ **DATA SIGNAL INDICATOR LAMP (ORANGE):** Illuminates when the device has a valid connection to the base unit.
- ⑤ **SERVICE PORT:** Used for firmware update.
- ⑥ **IR IN:** Connect to the IR Receiver cable. The IR signal will send to the IR OUT port of the transmitter.
- ⑦ **DC 12V:** Plug DC 12V/1A power supply into the unit and connect the adapter to an AC outlet.
(Note: The CAT receiver also can be powered by the transmitter via a CAT cable.)

EDID MODE

The defined EDID setting list of the product is shown as below:

EDID MODE	EDID DESCRIPTION
11111	1080P, Stereo Audio 2.0
11110	1080P, Dolby/DTS 5.1
11101	1080P, HD Audio 7.1
11100	1080I, Stereo Audio 2.0
11011	1080I, Dolby/DTS 5.1
11010	1080I, HD Audio 7.1
11001	1080P 3D, Stereo Audio 2.0
11000	1080P 3D, Dolby/DTS 5.1
10111	1080P 3D, HD Audio 7.1
10110	4K2K30Hz_444, Stereo Audio 2.0
10101	4K2K30Hz_444, Dolby/DTS 5.1
10100	4K2K30Hz_444, HD Audio 7.1
10011	4K2K60Hz_420, Stereo Audio 2.0
10010	4K2K60Hz_420, Dolby/DTS 5.1
10001	4K2K60Hz_420, HD Audio 7.1
10000	4K2K60Hz_444, Stereo Audio 2.0
01111	4K2K60Hz_444, Dolby/DTS 5.1
01110	4K2K60Hz_444, HD Audio 7.1
01101	4K2K60Hz_444, Stereo Audio 2.0 HDR
01100	4K2K60Hz_444, Dolby/DTS 5.1 HDR
01011	4K2K60Hz_444, HD Audio 7.1HDR
01010	COPY_FROM_LOOP OUT
01001	COPY_FROM_CAT OUT1
01000	COPY_FROM_CAT OUT2
00111	COPY_FROM_CAT OUT3
00110	COPY_FROM_CAT OUT4
00101	COPY_FROM_CAT OUT5
00100	COPY_FROM_CAT OUT6
00011	COPY_FROM_CAT OUT7
00010	COPY_FROM_CAT OUT8
00001	1080P, Stereo Audio 2.0
00000	PC control mode

ASCII COMMANDS

The product also supports ASCII command control. Connect the SERVICE port of the product to a PC with an USB cable. Then, open a Serial Command tool on PC to send ASCII commands to control the product. The ASCII command list about the product is shown as below.

SERIAL PORT PROTOCOL:

Baud rate: 115200

Data bits: 8 bit

Stop bits: 1

Check bit: 0

x - Parameter 1

y - Parameter 2

! - Delimiter

s = Set command

r = Report command

COMMAND CODE	FUNCTION DESCRIPTION	EXAMPLE	FEEDBACK	DEFAULT SETTING
POWER				
s power z!	Power on/off the device, z=0~1 (z=0 power off, z=1 power on)	s power 1!	Power ON System Initializing... Initialization Finished! power off POWER 0	POWER ON
r power!	Get current power state	r power!	power on/power off	
s reboot!	Reboot the device	s reboot!	reboot	
SYSTEM SETUP				
help!	List all commands	help!		
r type!	Get device model	r type!	ANI-0108POE-AU	
r status!	Get device current status	r status!	Get the unit all status: power, beep, lock, in/out connection, video/audio crosspoint, edid, scaler, network status	
r fw version!	Get Firmware version	r fw version!	MCU BOOT: Vx.xx.xx MCU APP: Vx.xx.xx	
r link in!	Get the connection status of the input port	r link in!	HDMI IN: connect	
r link out y!	Get the connection status of the y output port, y=0~8 (0=all, 1~8=CAT 1~8)	r link out 1!	CAT OUT1: connect	
r link loop out y!	Get the connection status of the y loop output port, y=1	r link loop out 1!	HDMI LOOP OUT: connect	
s reset!	Reset to factory defaults	s reset!	Reset to factory defaults System Initializing... Initialization Finished! FW version x.xx.xx	
OUTPUT SETTING				
s hdmi stream z!	Set HDMI loop output stream on/off z=0~1 (0: disable, 1: enable)	s hdmi stream 1!	Enable HDMI loop out stream Disable HDMI loop out stream	ENABLE
s cat y stream z!	Set CAT output y stream on/off, y=0~8 (0=all) z=0~1 (0: disable, 1: enable)	s cat 1 stream 1! s cat 0 stream 1!	Reset to factory defaults System Initializing... Initialization Finished! FW version x.xx.xx	

ASCII COMMANDS

COMMAND CODE	FUNCTION DESCRIPTION	EXAMPLE	FEEDBACK	DEFAULT SETTING
OUTPUT SETTING				
s hdmi stream z!	Set HDMI loop output stream on/off z=0~1 (0: disable, 1: enable)	s hdmi stream 1!	Enable HDMI loop out stream Disable HDMI loop out stream	ENABLE
s cat y stream z!	Set CAT output y stream on/off, y=0~8 (0=all) z=0~1 (0: disable, 1: enable)	s cat 1 stream 1 ! s cat 0 stream 1 !	Enable CAT output 1 stream Disable CAT output 1 stream Enable CAT all outputs stream Disable CAT all outputs stream	ENABLE
r hdmi stream!	Get HDMI loop out stream status	r hdmi stream!	Enable HDMI loop output stream	
r cat y stream!	Get CAT output y stream status, y=0~8 (0=all)	r cat 1 stream!	Enable CAT output 1 stream	
s hdmi hdcpc z!	Set HDMI loop output port HDCP status	s hdmi hdcpc 1!	HDMI loop out HDCP on	ALL HDMI OUT HDCP ACTIVE
r hdmi hdcpc!	Get HDCP status of loop out	r hdmi hdcpc!	HDMI loop out HDCP on	
s cat y hdcpc z!	Set CAT output y port HDCP status y=0~2 (0=all) z=0~1 (1=on, 0=off)	s cat 1 hdcpc 1!	CAT out 1 HDCP on	ALL CAT OUT HDCP ACTIVE
r cat y hdcpc!	Get HDCP status of CAT out y, y=0~2 (0=all)	r cat 1 hdcpc!	CAT out 1 HDCP on	
s cat y dsc mode z!	Set CAT output y port DSC mode status y=0~8 (0=all) z=1~3 (1=CAT distance 50M, 2=CAT distance 35M Mode, 3=CAT distance 70M Mode)	s cat 1 dsc mode 2!	CAT out 1 DSC mode 2	CAT CABLE DISTANCE 70M
r cat y dsc mode!	Get DSC mode of CAT out y, y=0~8 (0=all)	r cat 1 dsc mode!	CAT out 1 DSC mode 2	
s audio mute 1!	Set audio output port mute status (1-mute, 0-umute)	s audio mute 1!	s audio mute 1	S AUDIO UNMUTE (0)
r audio mute!	Get audio output mute status	r audio mute!	audio mute 1	
EDID SETTING				
s edid in from z!	Set input EDID from default EDID z, z=1~30 1. 1080p, Stereo Audio 2.0 2. 1080p, Dolby/DTS 5.1 3. 1080p, HD Audio 7.1 4. 1080i, Stereo Audio 2.0 5. 1080i, Dolby/DTS 5.1 6. 1080i, HD Audio 7.1 7. 3D, Stereo Audio 2.0 8. 3D, Dolby/DTS 5.1 9. 3D, HD Audio 7.1	s edid in from 1!	input EDID: 1080p, Stereo Audio 2.0 Please toggle EDID dip switch to 00000!	1080P, STEREO AUDIO 2.0

ASCII COMMANDS

COMMAND CODE	FUNCTION DESCRIPTION	EXAMPLE	FEEDBACK	DEFAULT SETTING
s edid in from z! CONT'D	10. 4K2K30_444, Stereo Audio 2.0 11. 4K2K30_444, Dolby/DTS 5.1 12. 4K2K30_444, HD Audio 7.1 13. 4K2K60_420, Stereo Audio 2.0 14. 4K2K60_420, Dolby/DTS 5.1 15. 4K2K60_420, HD Audio 7.1 16. 4K2K60_444, Stereo Audio 2.0 17. 4K2K60_444, Dolby/DTS 5.1 18. 4K2K60_444, HD Audio 7.1 19. 4K2K60_444, Stereo Audio 2.0 HDR 20. 4K2K60_444, Dolby/DTS 5.1 HDR 21. 4K2K60_444, HD Audio 7.1 HDR 22. Copy from HDMI loop out 23. Copy from CAT output 1 24. Copy from CAT output 2 25. Copy from CAT output 3 26. Copy from CAT output 4 27. Copy from CAT output 5 28. Copy from CAT output 6 29. Copy from CAT output 7 30. Copy from CAT output 8			
r edid in!	Get EDID status of the input	r edid in!	input EDID: 4K2K60_444, Stereo Audio 2.0	
r edid in data!	Get the EDID data of the HDMI input	r edid in data!	EDID data: 00 FF FF FF FF FF FF 00	

1. Connect HDMI Extender base unit using the included USB to USB Micro-B USB cable.
2. Open “CommOp.exe” (*Available for download on our website) select the correct COM port and baud rate: “115200”.

**This program is provided as a courtesy. We do not provide any support for using this or any other 3rd party terminal control software.*

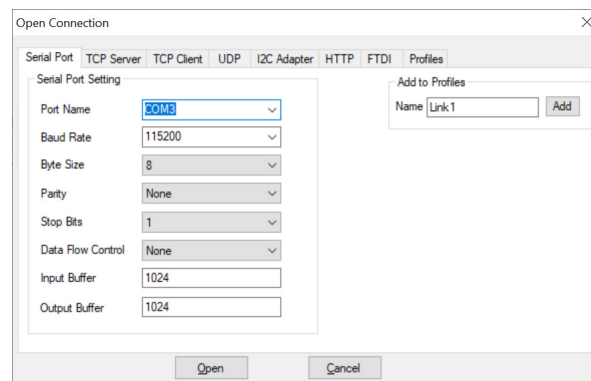
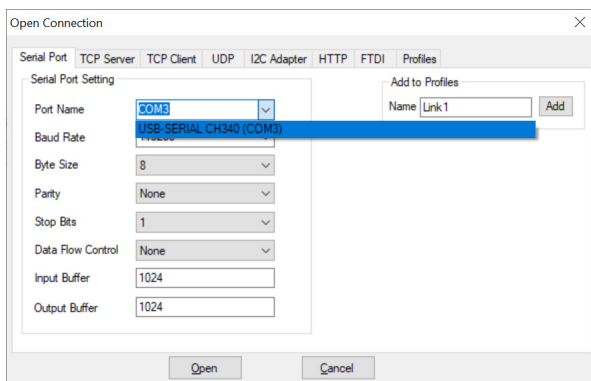

3. In this example Input command on CommOp tool to get CAT cable length mode on port #1:

a. **r cat 1 dsc mode!**

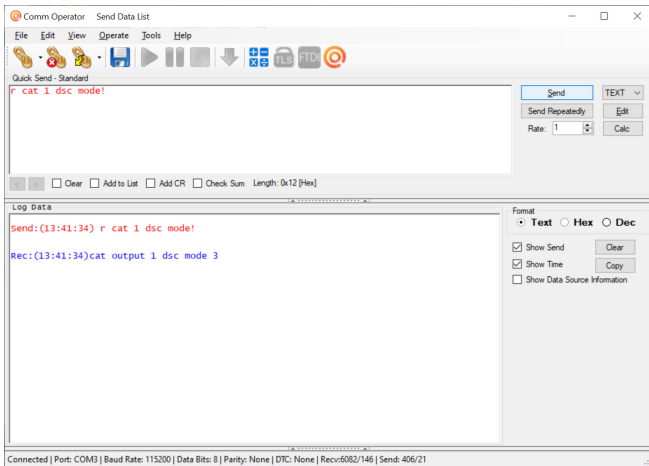

IR PIN DEFINITION



IR Receiver



IR Blaster

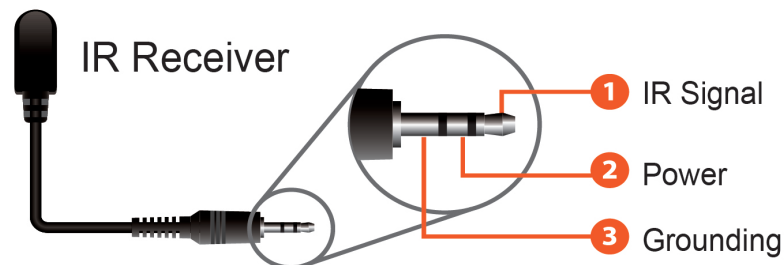
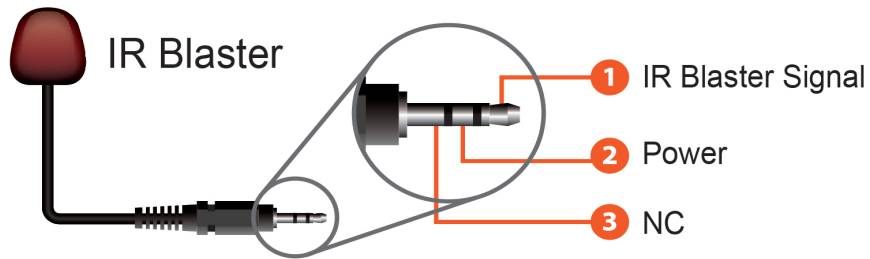

APPLICATION EXAMPLE

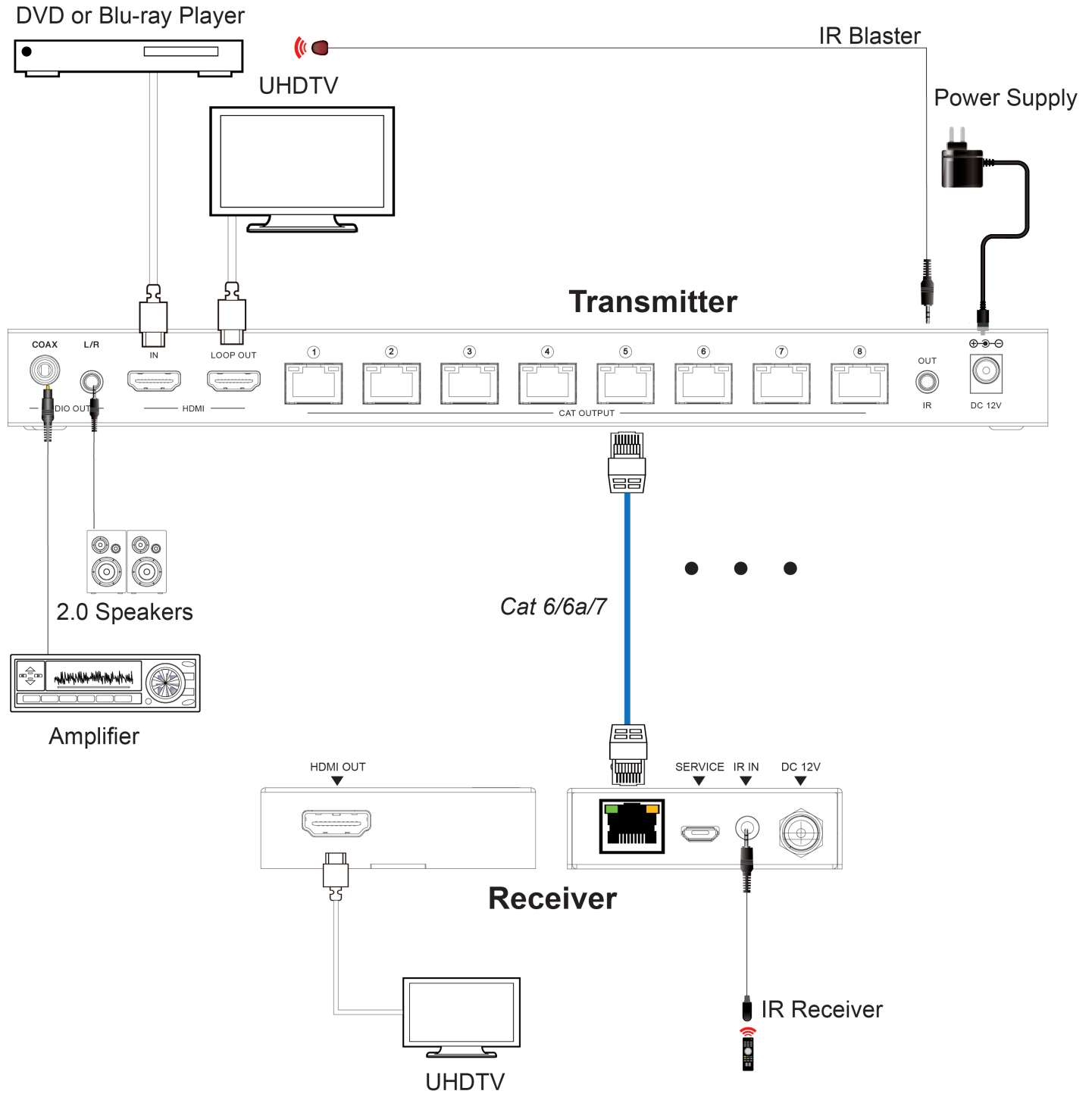

THIS PAGE IS INTENTIONALLY LEFT BLANK.

THIS PAGE IS INTENTIONALLY LEFT BLANK.

PLEASE READ THE FOLLOWING TERMS AND CONDITIONS CAREFULLY BEFORE USING THIS HARDWARE, COMPONENTS AND SOFTWARE PROVIDED BY, THROUGH OR UNDER A-NeuVideo, INC (COLLECTIVELY, THE "PRODUCT"). By using installing or using the Product, you unconditionally signify your agreement to these Terms and Conditions. If you do not agree to these Terms and Conditions, do not use the Product and return the Product to A-NeuVideo, Inc. at the return address set forth on the Product's packing label at your expense. A-NeuVideo, Inc. may modify these Terms and Conditions at anytime, without notice to you.

RESTRICTIONS ON USE OF THE PRODUCT

It is your responsibility to read and understand the installation and operation instructions, both verbal and in writing, provided to you with respect to the Product. You are authorized to use the Product solely in connection with such instructions. Any use of the Product not in accordance with such instructions shall void any warranty pertaining to the Product. Any and all damages that may occur in the use of the Product that is not strictly in accordance with such instructions shall be borne by you and you agree to indemnify and hold harmless A-NeuVideo, Inc. from and against any such damage.

The Product is protected by certain intellectual property rights owned by or licensed to A-NeuVideo. Any intellectual property rights pertaining to the Product are licensed to you by A-NeuVideo, Inc. and/or its affiliates, including any manufacturers or distributors of the Product (collectively, "A-NeuVideo") for your personal use only, provided that you do not change or delete any proprietary notices that may be provided with respect to the Product.

The Product is sold to you and any use of any associated intellectual property is deemed to be licensed to you by A-NeuVideo for your personal use only. A-NeuVideo does not transfer either the title or the intellectual property rights to the Product and A-NeuVideo retains full and complete title to the intellectual property rights therein. All trademarks and logos are owned by A-NeuVideo or its licensors and providers of the Product, and you may not copy or use them in any manner without the prior written consent of A-NeuVideo, which consent may be withheld at the sole discretion of A-NeuVideo.

The functionality and usability of the Product is controlled by A-NeuVideo, Inc. from its offices within the State of Texas, United States of America. A-NeuVideo makes no representation that materials pertaining to the Product are appropriate or available for use in other locations other than the shipping address you provided with respect thereto. You are advised that the Product may be subject to U.S. export controls.

DISCLAIMERS AND LIMITATION OF LIABILITY

A-NeuVideo may change or modify the Product at any time, from time to time.

THE PRODUCT IS PROVIDED "AS IS" AND WITHOUT WARRANTIES OF ANY KIND EITHER EXPRESS OR IMPLIED. A-NEUVIDEO DOES NOT WARRANT OR MAKE ANY REPRESENTATIONS REGARDING THE USE OR THE RESULTS OF THE USE OF THE PRODUCT'S CORRECTNESS, ACCURACY, RELIABILITY, OR OTHERWISE.

A-NeuVideo has no duty or policy to update any information or statements pertaining to the Product and, therefore, such information or statements should not be relied upon as being current as of the date you use the Product. Moreover, any portion of the materials pertaining to the Product may include technical inaccuracies or typographical errors. Changes may be made from time to time without notice with respect to the Product.

TO THE FULLEST EXTENT PERMISSIBLE PURSUANT TO APPLICABLE LAW, A-NEUVIDEO DISCLAIMS ALL WARRANTIES, EXPRESS OR IMPLIED, INCLUDING, BUT NOT LIMITED TO IMPLIED WARRANTIES OF MERCHANTABILITY, FITNESS FOR A PARTICULAR PURPOSE AND NON-INFRINGEMENT. A-NEUVIDEO DOES NOT WARRANT THE ACCURACY, COMPLETENESS OR USEFULNESS OF ANY INFORMATION WITH RESPECT TO THE PRODUCT. A-NEUVIDEO DOES NOT WARRANT THAT THE FUNCTIONS PERTAINING TO THE PRODUCT WILL BE ERROR-FREE, THAT DEFECTS WITH RESPECT TO THE PRODUCT WILL BE CORRECTED, OR THAT THE MATERIALS PERTAINING THERETO ARE FREE OF DEFECTS OR OTHER HARMFUL COMPONENTS. A-NEUVIDEO WILL USE ITS REASONABLE EFFORTS TO CORRECT ANY DEFECTS IN THE PRODUCT UPON TIMELY WRITTEN NOTICE FROM YOU NOT TO EXCEED 10 BUSINESS DAYS AFTER RECEIPT BY YOU OF THE PRODUCT, BUT YOU (AND NOT A-NEUVIDEO) ASSUME THE ENTIRE COST OF ALL NECESSARY SERVICING, REPAIR AND CORRECTION THAT WAS CAUSED BY YOU UNLESS OTHERWISE AGREED TO IN A SEPARATE WRITING BY A-NEUVIDEO.

UNDER NO CIRCUMSTANCES, INCLUDING, BUT NOT LIMITED TO, NEGLIGENCE, SHALL A-NEUVIDEO BE LIABLE FOR ANY SPECIAL OR CONSEQUENTIAL DAMAGES THAT RESULT FROM THE USE OF, OR THE INABILITY TO USE THE PRODUCT IN ACCORDANCE WITH ITS SPECIFICATIONS, EVEN IF A-NEUVIDEO OR ITS REPRESENTATIVES HAVE BEEN ADVISED OF THE POSSIBILITY OF SUCH DAMAGES. IN NO EVENT SHALL A-NEUVIDEO'S TOTAL LIABILITY TO YOU FROM ALL DAMAGES, LOSSES, AND CAUSES OF ACTION (WHETHER IN CONTRACT, OR OTHERWISE) EXCEED THE AMOUNT YOU PAID TO A-NEUVIDEO, IF ANY, FOR THE PRODUCT.