

OG-FiDO-12G Series

openGear Card

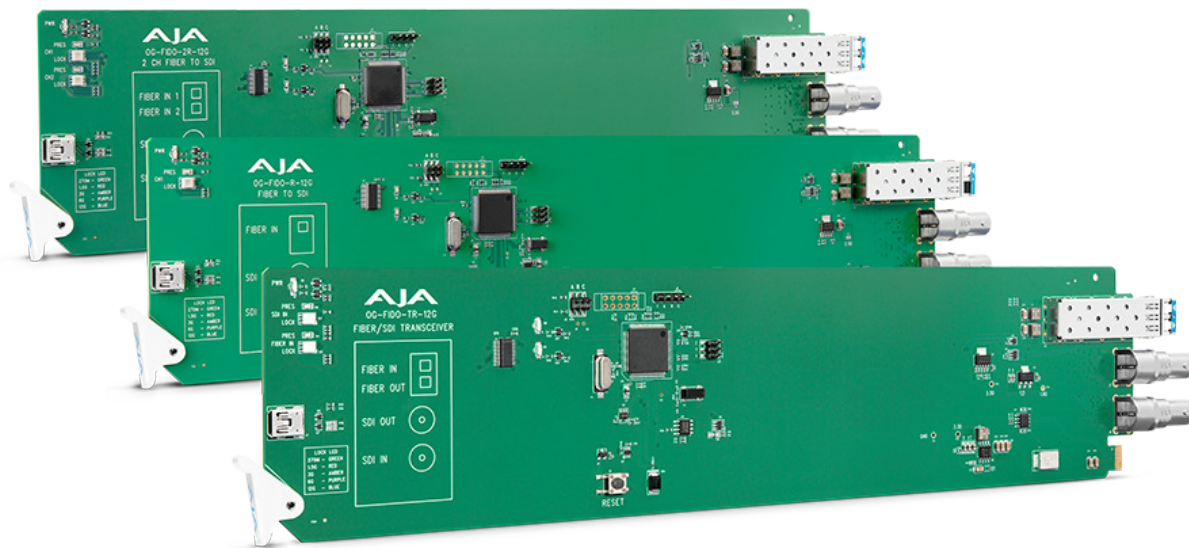

Installation and Operation Guide

Version 2.0.1r1
Published June 23, 2021



Notices

Trademarks

AJA® and Because it matters.® are registered trademarks of AJA Video Systems, Inc. for use with most AJA products. AJA™ is a trademark of AJA Video Systems, Inc. for use with recorder, router, software and camera products. Because it matters.™ is a trademark of AJA Video Systems, Inc. for use with camera products.

Corvid Ultra®, Io®, Ki Pro®, KONA®, KUMO®, ROI® and T-Tap® are registered trademarks of AJA Video Systems, Inc.

AJA Control Room™, KiStor™, Science of the Beautiful™, TruScale™, V2Analog™ and V2Digital™ are trademarks of AJA Video Systems, Inc.

All other trademarks are the property of their respective owners.

Copyright

Copyright © 2021 AJA Video Systems, Inc. All rights reserved. All information in this manual is subject to change without notice. No part of the document may be reproduced or transmitted in any form, or by any means, electronic or mechanical, including photocopying or recording, without the express written permission of AJA Video Systems, Inc.

Contacting AJA Support

When calling for support, have all information at hand prior to calling. To contact AJA for sales or support, use any of the following methods:

Telephone	+1.530.271.3190
FAX	+1.530.271.3140
Web	https://www.aja.com
Support Email	support@aja.com
Sales Email	sales@aja.com

Contents

Notices	2
Trademarks	2
Copyright	2
Contacting AJA Support	2
Chapter 1 – OG-FiDO-12G-Series	4
Card Series Overview	4
Features	5
Connectors	6
LED Indicators	6
Block Diagram	8
Signal Indicators in the DashBoard Control System	8
User Controls	11
DashBoard Control System	11
openGear and AJA	12
Installation	12
Summary	12
Unpacking	12
Parts Supplied	13
Rear OG-FiDO-12G Series Card Installation	13
Front OG-FiDO-12G Series Card Installation	13
Cabling	16
Chapter 2 – Operation	17
Using the DashBoard Control System	17
Requirements	17
Configuration Settings Stored in OG Card	17
Control Interface Basic Components	17
Basic Tree View of Frames and Cards	18
Card Information and Status	18
Parameter Controls	18
Card Tab Screen	19
Signal Status Tab Screen	20
SFP Tab Screen	21
Setup Tab Screen	22
Uploading New Software	22
Rebooting	25
Appendix A – Specifications	27
OG-FiDO-TR-12G	27
OG-FiDO-R-12G-ST	28
OG-FiDO-2R-12G	29
Appendix B – Safety and Compliance	30
Warranty and Liability Information	40
Limited Warranty on Hardware	40
Limitation of Liability	40
Governing Law and Language; Your Rights	40

Chapter 1 – OG-FiDO-12G-Series

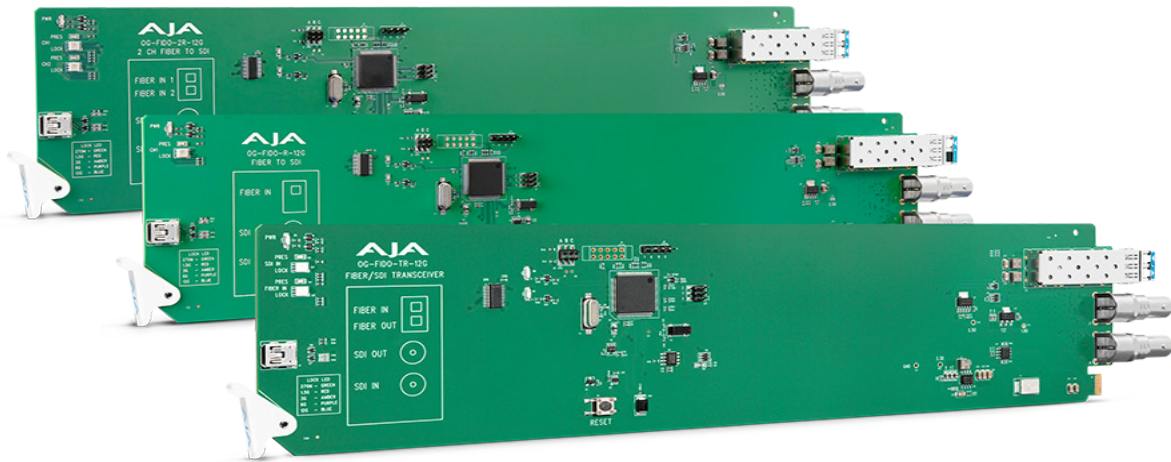

Card Series Overview

The OG-FiDO-12G Series cards are state-of-the-art, openGear-compatible, 12G-SDI to/from Fiber converter cards, enabling SDI signals to be extended up to 10km over standard Single-Mode fiber optic cable.

Three AJA cards are available in the OG-FiDO-12G Series:

- OG-FiDO-TR-12G, 1-Channel 12G-SDI/LC Single-Mode LC Fiber Transceiver
- OG-FiDO-R-12G-ST, 1-Channel Single-Mode ST Fiber to 12G-SDI Receiver
- OG-FiDO-2R-12G, 2-Channel Single-Mode LC Fiber to 12G-SDI Receiver

The inputs are re-clocked with best-in-class input jitter tolerance. The two channel cards have completely independent paths, allowing different SDI rates to be carried on each channel.

The fiber SFP cage is attached to the main card for added reliability and cost savings.

NOTE: In order to allow direct fiber connection to the card, and avoid problematic optical couplers, AJA FiDO openGear cards have the SFP cage attached to the front card. This means that the card cannot be removed from the frame with the SFP module, cables, and/or BNC retaining nuts installed.

Features

- Video Formats: 270 Mbps - 12 Gbps, format agnostic
- OG-FiDO-TR-12G
 - Inputs: 1x 12G-SDI BNC; 1x Single-Mode LC Fiber Connectors
 - Outputs: 1x 12G-SDI BNC; 1x Single-Mode LC Fiber Connectors
- OG-FiDO-R-12G-ST
 - Inputs: 1x Single-Mode ST Fiber Connectors
 - Outputs: 1x 12G-SDI BNC with SDI Loop out
- OG-FiDO-2R-12G
 - Inputs: 2x Independent Single-Mode LC Fiber Connectors
 - Outputs: 2x Independent 12G-SDI, BNC connectors
- LC Fiber connectors (for models -TR-12G, -2R-12G)
- ST Fiber connectors (for model -R-12G-ST)
- Support for HDR - High Dynamic Range video
- Input Present and Input SMPTE Lock LEDs
- Automatic detection and re-clocking of 270Mb, 1.5Gb, 3Gb, 6Gb and 12Gb SDI data rates
- All SDI or fiber inputs are re-clocked, and SDI inputs are also equalized
- 270 Mbps, 1.483 Gbps, 1.485 Gbps, 2.967 Gbps, 2.970 Gbps, 5.934 Gbps, 5.940 Gbps, 11.868 Gbps, 11.880 Gbps - Auto Select
- All outputs are DVB-ASI compatible
- Nominal Wavelength; Tx: 1310 nm (typ), Rx :1260-1620 nm (model -TR-12G)
- Nominal Wavelength; Rx :1260-1620 nm (model -R-12G-ST)
- Nominal Wavelength; Rx :1260-1620 nm (model -2R-12G)
- Power: 3 watts Max
- Hot-swappable
- Remote Ethernet Monitoring and Firmware Updating through Ross DashBoard software
- Appropriate Fiber SFP included
- Rear I/O card included
- Two slots required for each card
- Compatible with OG-X-FR, OG-3-FR, and DFR-8321 openGear frames
- Five year warranty

Connectors

Figure 1. Rear View of Empty Rear Card and Installed Dual Channel FiDO Cards

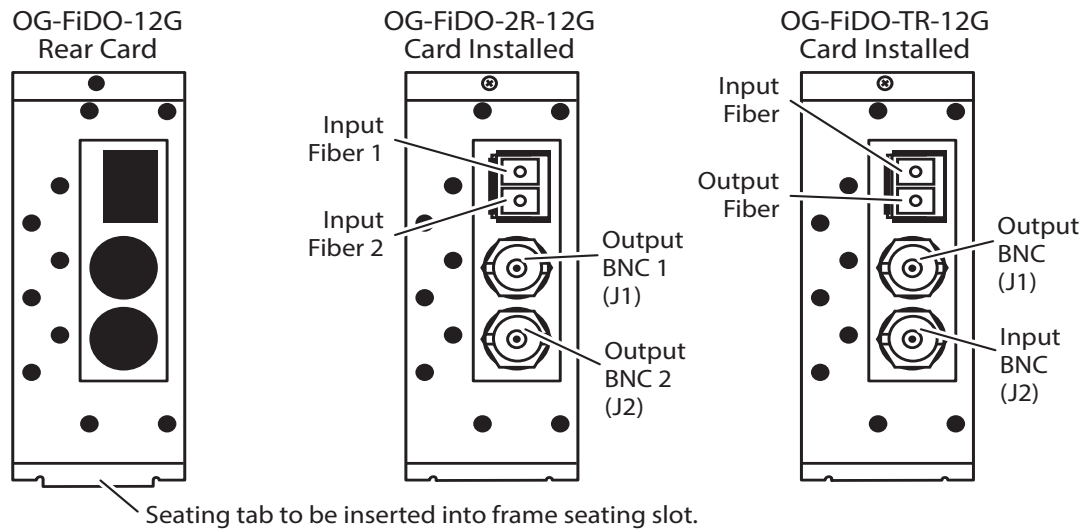
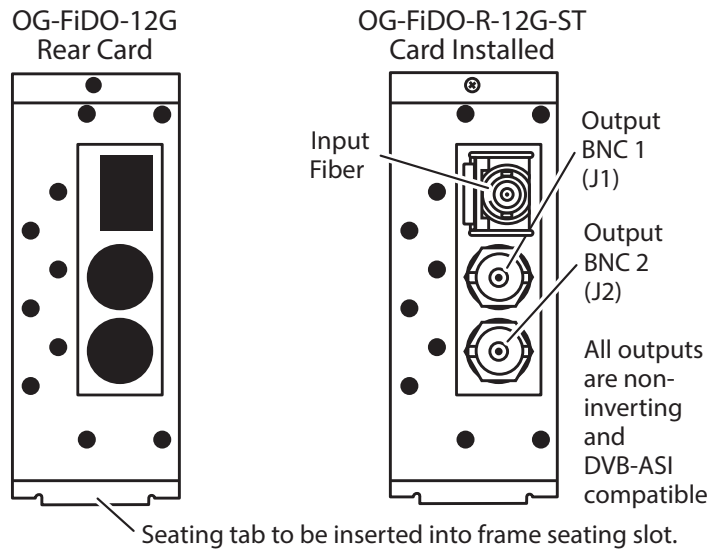

Figure 2. Rear View of Empty Rear Card and Installed Single Channel FiDO Cards



LED Indicators

LEDs on the front (near door) of each card indicate, from top to bottom:

OG-FiDO-TR Cards

Power LED

The Power LED indicates the state of the card as displayed in DashBoard. When power is present, it can be green, yellow or red.

- Green: no DashBoard card state alarm is present.
- Yellow: a yellow DashBoard card state alarm is present. See DashBoard for more information.

- Red: a red DashBoard card state alarm is present. See DashBoard for more information.

Pres LED

- Ch 1 signal present (green)
- Ch 2 signal present (green)

Lock LED

The RGB Lock LEDs adjacent to each SDI channel label indicate by color the detected signal data rate:

- Off: no signal
- Green: SD
- Red: HD
- Amber: 3G
- Purple: 6G
- Blue: 12G

OG-FiDO-R Cards

Power LED

The Power LED indicates the state of the card as displayed in DashBoard. When power is present, it can be green, yellow or red.

- Green: no DashBoard card state alarm is present.
- Yellow: a yellow DashBoard card state alarm is present. See DashBoard for more information.
- Red: a red DashBoard card state alarm is present. See DashBoard for more information.

Pres LED

- Ch 1 signal present (green)

Lock LED

The RGB Lock LED adjacent to the SDI channel label indicates by color the detected signal data rate:

- Off: no signal
- Green: SD
- Red: HD
- Amber: 3G
- Purple: 6G
- Blue: 12G

OG-FiDO-2R Cards

Power LED

The Power LED indicates the state of the card as displayed in DashBoard. When power is present, it can be green, yellow or red.

- Green: no DashBoard card state alarm is present.
- Yellow: a yellow DashBoard card state alarm is present. See DashBoard for more information.

- Red: a red DashBoard card state alarm is present. See DashBoard for more information.

Pres LED

- Ch 1 signal present (green)
- Ch 2 signal present (green)

Lock LED

The RGB Lock LEDs adjacent to each SDI channel label indicate by color the detected signal data rate:

- Off: no signal
- Green: SD
- Red: HD
- Amber: 3G
- Purple: 6G
- Blue: 12G

Block Diagram

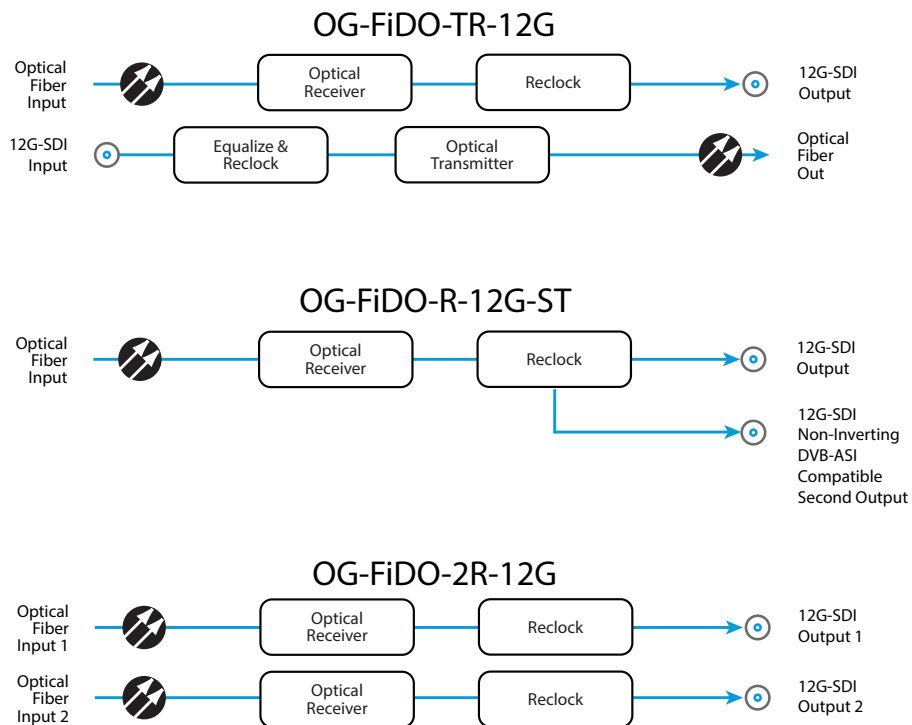

Signal Indicators in the DashBoard Control System

Card Alarm State – Yellow

SDI Signal Not Present, Fiber Signal Not Present

When the signal is either not present or is not locked, the DashBoard Control System shows a yellow Card State alarm: "Signal Status No Signal."

Additionally, under the Signal Status tab for both SDI IN and FIBER IN, the Signal Status is shown as "No Signal," and the Input Lock is shown as "No Lock."

For 2 channel models, this alarm will be on if either of the inputs is not present.

Figure 3. Signal Status No Signal

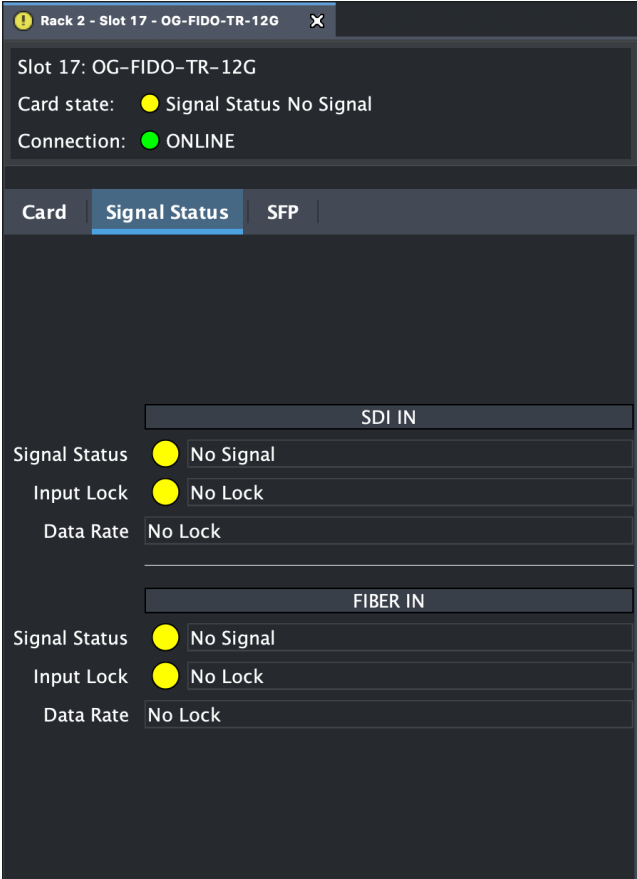

Card Alarm State – Yellow

SDI Signal Present, Fiber Signal Not Present

The screen capture below shows an example in which there is an SDI signal present and locked, but there is no Fiber signal present. In that case, the DashBoard Control System shows a yellow Card State with the message "Signal Status No Signal."

Additionally, under the Signal Status tab, the SDI IN Signal Status is shown as "Signal Present," and the Input Lock is shown as "Locked," while the FIBER IN Signal Status displays "No Signal," and the Input Lock displays "No Lock."

Figure 4. SDI Input Signal present and locked, Fiber Input Signal not present

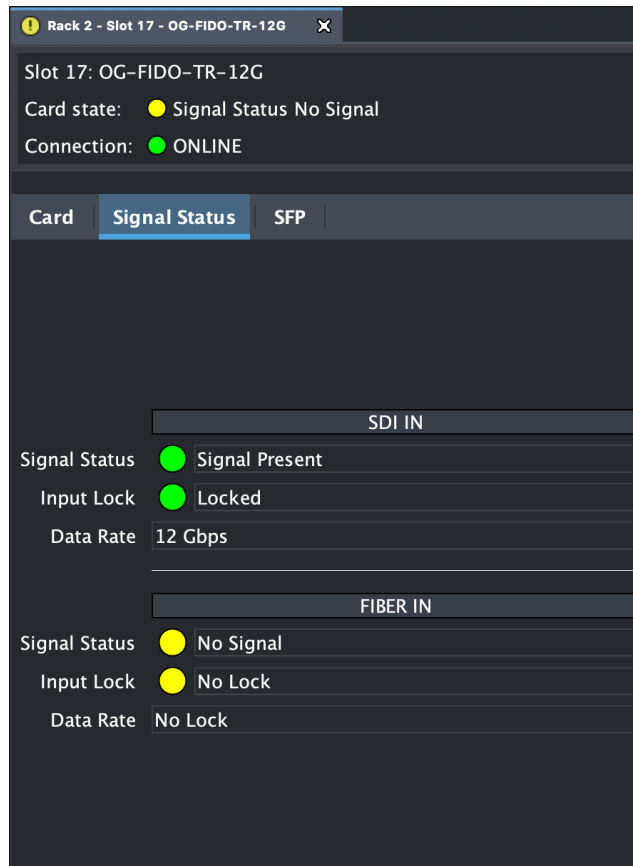

Card Alarm State – Green

SDI and Fiber Signals Present

When there is a valid input signal detected for both SDI IN and FIBER IN, the DashBoard Control System shows a green Card State.

Additionally, under the Signal Status tab for both SDI IN and FIBER IN, the Signal Status is shown as "Signal Present," and the Input Lock is shown as "Locked." The detected Data Rate of the SDI and Fiber Signals are also indicated (for example, "12 Gbps").

Figure 5. Signal is present and locked

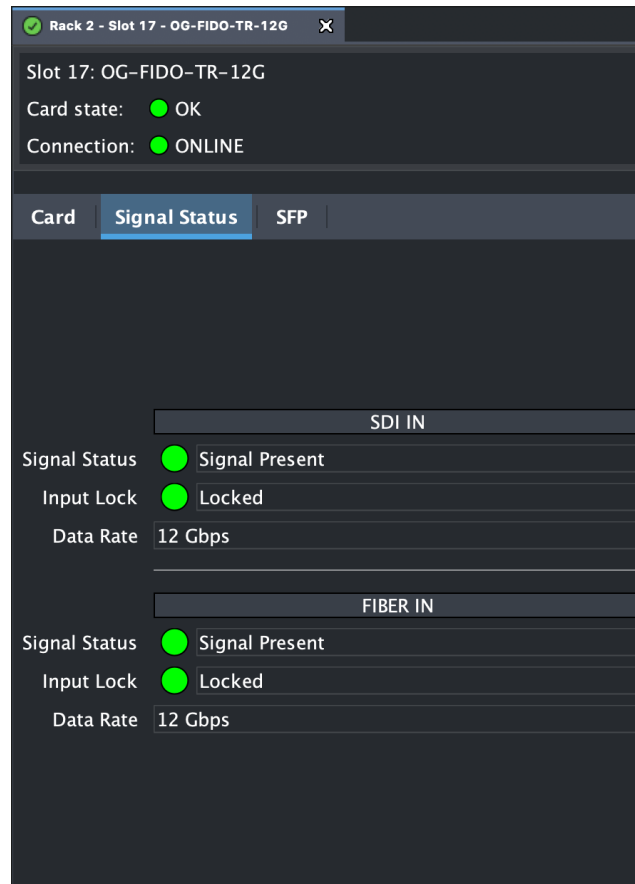

User Controls

The OG-FiDO-12G Series cards can be used right out of the box for many applications, since they are designed to recognize inputs and perform standard actions automatically. However, you can also remotely monitor the OG-FiDO-12G Series through the DashBoard Control System for an openGear Frame.

DashBoard Control System

The DashBoard Control System, created by Ross Video, provides a control interface between Windows, macOS and Linux computers and the cards installed in an openGear frame. DashBoard operates through TCP/IP communication and requires an Ethernet connection between the controlling computer and an openGear frame.

For details about acquiring and using the DashBoard Control System, refer to ["Using the DashBoard Control System" on page 17.](#)

openGear and AJA

openGear is an open-architecture, modular frame system designed by Ross Video and supported by a diverse range of terminal equipment manufacturers, including AJA. Ross Video manufactures the frames, power supplies and network cards for openGear. AJA is a reseller of the openGear frames.

AJA Video is a leading manufacturer of video interface technologies, converters, digital video recording solutions and professional cameras, bringing high-quality, cost-effective products to the professional, broadcast and post-production markets. AJA products, including openGear cards, are designed and manufactured at our facilities in Grass Valley, California.

Installation



Warning! Active fiber-optic cables emit radiation invisible to the human eye. Do not look directly at the end of an active fiber-optic cable or the fiber connector on an OG-FiDO-TR-12G; this model is a Class 1 Laser Product.

Summary

Installing an OG-FiDO-12G card into a DFR-8321, OG3 or OGX openGear frame consists of the following steps:

1. Install a Rear Fiber Card into the frame.
2. Ensure the SFP module is removed from the Front FiDO Card.
3. Insert the Front FiDO card in the left (odd numbered) slot of the pair.

NOTE: When seating the card, it may be necessary to slightly lift and pull the card's BNC connectors from the rear of the openGear frame in order to align the card correctly.

4. Install BNC connector retaining nuts and washers.
5. Insert the SFP module into the card from the rear of the frame.
6. Connect the BNC and Fiber cabling.



ESD Susceptibility - Static discharge can cause serious damage to sensitive semiconductor devices. Avoid handling circuit boards in high static environments such as carpeted areas, and when wearing synthetic fiber clothing. Always exercise proper grounding precautions when working on circuit boards and related equipment.

Unpacking

Unpack each openGear product you received from the shipping container and ensure that all items are included. If any items are missing or damaged, contact your sales representative or AJA directly.

Parts Supplied

Each OG-FiDO-12G card is shipped with:

- OG-FiDO-12G card in an ESD bag
- Fiber Rear Card
- SFP module in ESD bag
- BNC nuts and star washers

Rear OG-FiDO-12G Series Card Installation

1. Ensure that the frame is properly installed.
2. Locate the card frame slot on the rear of the openGear frame into which you wish to install the openGear card.

NOTE: An OG-FiDO-12G card occupies two slots in the frame.

3. Using a Phillips screwdriver, unscrew the top screw from the desired blank rear plate and remove the rear plate.
4. Seat the bottom of the Rear Card in the seating slot at the base of the frame back plane ([Figure 6](#)).

Figure 6. Rear Card Inserted Into Frame Seating Slot

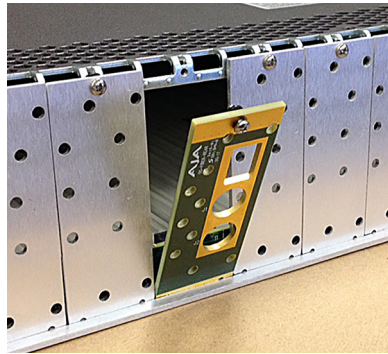

5. Align the top screw of the Rear Card with the screw hole on the top edge of the frame back plane.
6. Ensure the Rear Card aligns with the desired card slot before tightening the screw.

NOTE: To correctly orient the rear panel, make sure that the AJA logo is facing out.

7. Using a Phillips screwdriver, fasten the Rear Card to the frame back plane. Do not over tighten.
8. Ensure proper frame cooling and ventilation by having all rear frame slots covered with rear modules or blank metal plates if plates are not pre-installed.

Front OG-FiDO-12G Series Card Installation



Caution! The SFP module must be removed from an OG-FiDO-12G card before inserting the card into or removing the card from an openGear frame.

1. If necessary, remove the SFP module from the Front Card by lifting the lever (also referred to as a "bale") and pulling out the module.
2. If nuts and washers are pre-installed on the BNC connectors, they must be removed before inserting the card in the frame.
3. Open the openGear frame door as follows:

- A. Gently pull the side door tabs towards the center of the door, releasing the door from the frame.
- B. Using both hands, pull the door towards you. The door extender arms prevent the door from falling.
4. Locate the Rear Card you installed as described above. The interior slot number is dependent on the slot combinations into which you installed the Rear Card. This allows adequate spacing to avoid damaging the card, the cards installed in the neighboring slots, or both.
5. Hold the card by the edges and carefully align the card edges with the rails inside the frame. The slots are numbered starting from the left-most slot when facing the frame front.

NOTE: OG-FiDO-12G cards are installed into the left (odd numbered) slot of the pair.

6. Fully insert the card into the frame until the card is properly seated in the Rear Card. There are two stages to inserting the card:
 - A. After you feel the card's first click, its position in the frame will resemble the photograph below in [Figure 7](#).
 - B. Next, press against the white plastic tab again until you feel the second click. The card's position will resemble the photograph below in [Figure 8](#).

NOTE: Some cards require more pressure than others to be fully inserted. Make sure that the plastic tab at the bottom of the front edge of the card is completely upright. If it is tilting forward, the card is not yet fully inserted.

Figure 7. The card on the left is already fully inserted. The card on the right is not yet fully inserted, as indicated by the white plastic tab tilting forward.

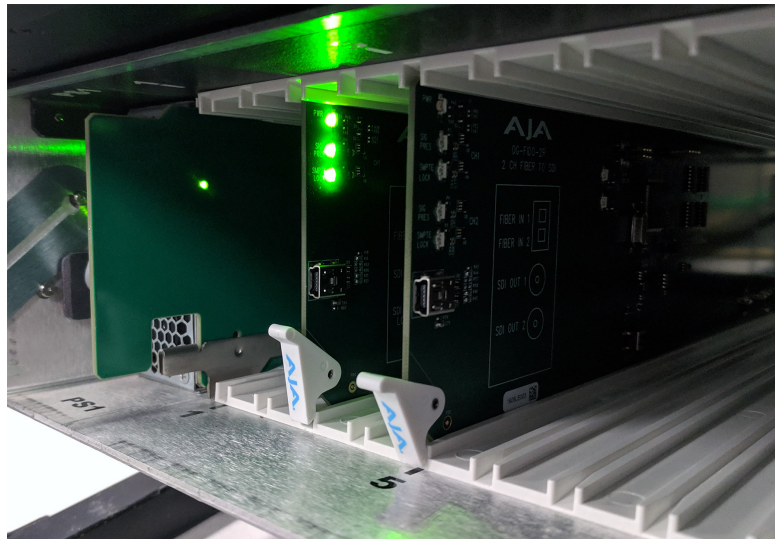
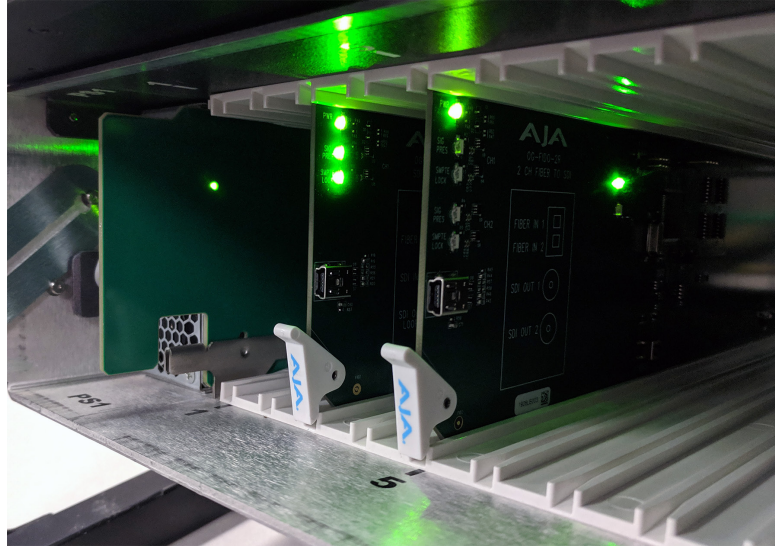
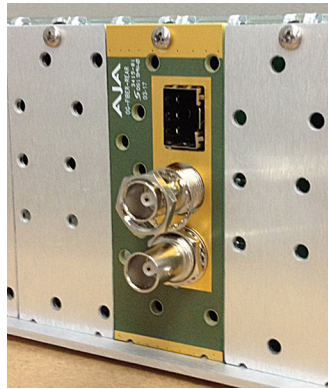

Figure 8. The white plastic tab for the card on the right is now upright. Both cards are shown fully inserted.



7. Close the frame door as follows:
 - A. Slide the door into the frame.
 - B. Pull and release the door tabs to ensure the frame door is securely locked to the frame.
8. Secure the card in the frame by the BNC connectors using the star washers and nuts provided (Figure 9).

Figure 9. BNC Star Washer and Nut Installation



9. Insert the SFP fiber module into the socket until it clicks and locks. The lever handle is on the left (Figure 10).

Figure 10. Fiber SFP Installation

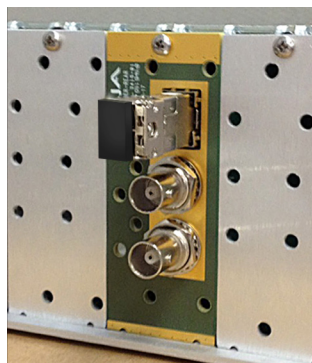

NOTE: The SFP module must match the card's capabilities for proper operation. Input and output triangles next to the fiber ports identify which are inputs and which are outputs (Figure 11).

Figure 11. An SFP Module



10. Close the frame door as follows:

- A. Slide the door into the frame.
- B. Pull and release the door tabs to ensure the frame door is securely locked to the frame.

Cabling

Refer to [Figure 1 on page 6](#) and [Figure 2 on page 6](#) to identify the input and output signal connectors.

NOTE: Keep the protective dust cap in the SFP module until the fiber cabling is actually connected to the module.

Chapter 2 – Operation

Using the DashBoard Control System

The DashBoard Control System is available as a free download from the openGear DashBoard Software Download webpage:

<https://www.opengear.tv/frame-and-control/control-system/download/>

Ross Video offers comprehensive documentation that covers the extensive capabilities of the DashBoard Control System:

<https://www.rossvideo.com/support/product-documentation/dashboard/>

This AJA OG-FiDO-12G Series manual addresses only those essential aspects of the DashBoard Control System needed to control the OG-FiDO-12G Series card.

Requirements

The DashBoard Control System requires the following components:

- openGear frame with a Frame Controller card
- Ethernet connection between the controlling computer and the openGear frame

NOTE: The openGear frame ships from AJA with the MFC-8322-S Frame Controller card for controlling the new AJA DashBoard cards. The openGear frame also supports the MFC-0G3-N Advanced Networking Frame Controller card, which can be used to control compatible OG cards.

DashBoard automatically discovers openGear and DashBoard Connect devices, such as openGear frames and cards that are present and accessible on your network.

Configuration Settings Stored in OG Card

Configuration settings made through DashBoard are stored in the OG-FiDO-12G Series units through subsequent power cycles.

Control Interface Basic Components

The basic components of the DashBoard Control System user interface consist of the basic tree view of frames and cards, the card information and status panel, and the parameter controls panel. These elements are shown below.

Figure 12. Main Sections of the Dashboard User Interface

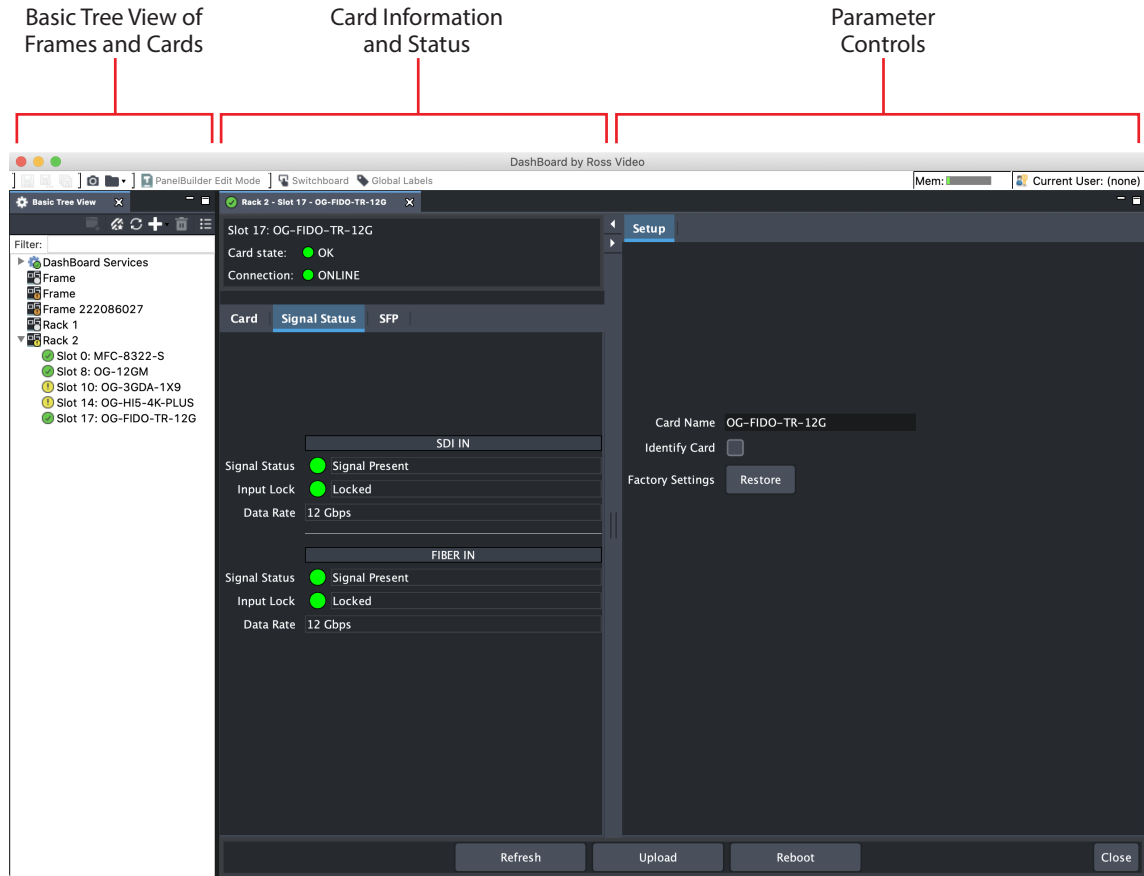

Basic Tree View of Frames and Cards

The basic tree view in the left column shows the frames and cards that are discoverable by Dashboard on your network.

Card Information and Status

The card information and status panel, shown in the middle panel, displays the basic status of the card currently selected in Dashboard. The yellow fields in this panel indicate that they are read-only.

Parameter Controls

The parameter controls panel on the right side of Dashboard shows the tabs and parameters that are configurable for the selected card.

Card Tab Screen

Figure 13. OG-FiDO-12G Series Card Tab Screen in Dashboard

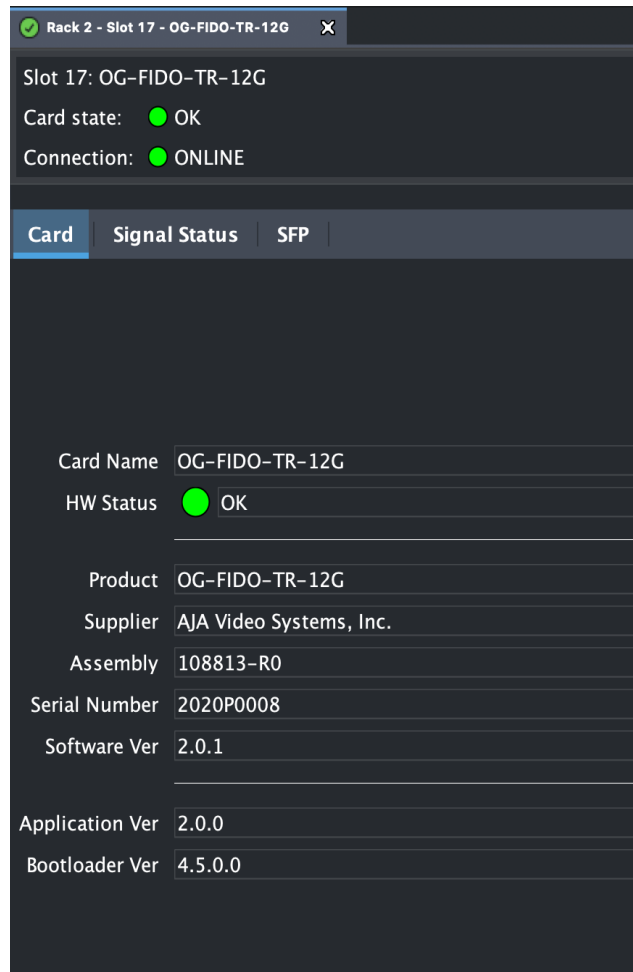

The Card tab screen indicates the basic information about the card itself such as the card name, hardware status, product, supplier, assembly, serial number, software version and other items.

Signal Status Tab Screen

Figure 14. OG-FiDO-12G Series Signal Status Tab Screen in Dashboard

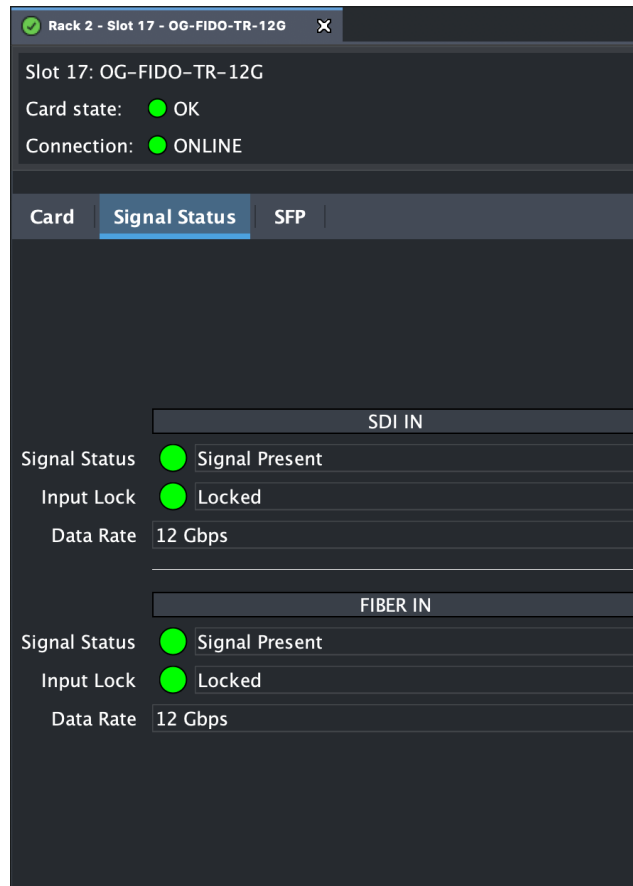

The Signal Status fields report the Signal Status, the Input Lock Status, and the Data Rate for SDI IN and FIBER IN.

SFP Tab Screen

Figure 15. OG-FiDO-12G Series SFP Tab Screen in Dashboard

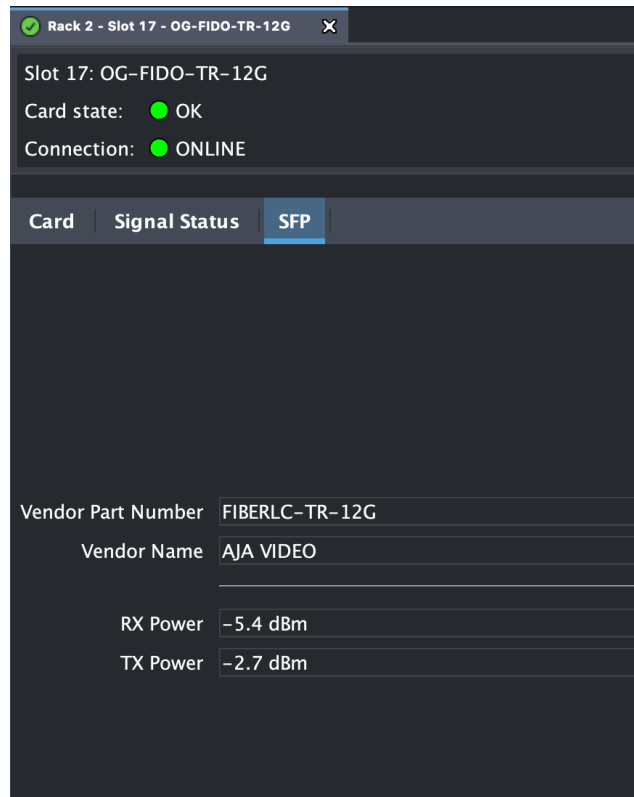

The SFP fields report on the following aspects of the SFP:

- Vendor Part Number
- Vendor Name
- RX Power (as applicable for the specific card)
- TX Power (as applicable for the specific card)

Setup Tab Screen

Figure 16. OG-FiDO-12G Series Setup Tab Screen in DashBoard

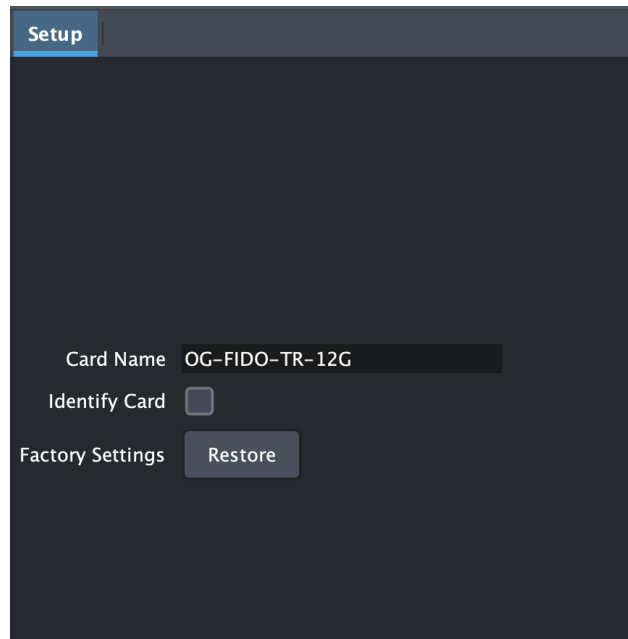

Click on the Setup tab to view and make changes to the card name or to restore card settings to factory default values.

Card Name - By default, this field is pre-populated with the card name (for example, OG-FIDO-TR-12G). You can change the card name by editing the text in the Card Name field.

NOTE: Changing the Card Name in the Setup tab also changes the name of the card in the DashBoard tree view.

Identify Card - Select the checkbox to turn on the Identify Card function. When this function is turned on, the Power LED light on the front of the OG-FiDO-12G Series card inside the openGear frame will blink an orange/amber color to help you quickly identify the card. Open the front of the openGear frame in order to see the light blinking.

Factory Settings - If you would like to revert the card settings to factory default values, click **Restore**.

Uploading New Software

When available, you can upload updated software to the OG-FiDO-12G Series through the DashBoard Control System by following the steps below.

To Upload New Software

1. Check the AJA website for new software for your OG-FiDO-12G Series. If new software is found, download it and uncompress the file archive (zip).
2. Click the Upload button in the lower panel of the DashBoard Control System to open the Upload Software Wizard.

Figure 17. OG-FiDO-12G Series Upload Software Wizard window in Dashboard

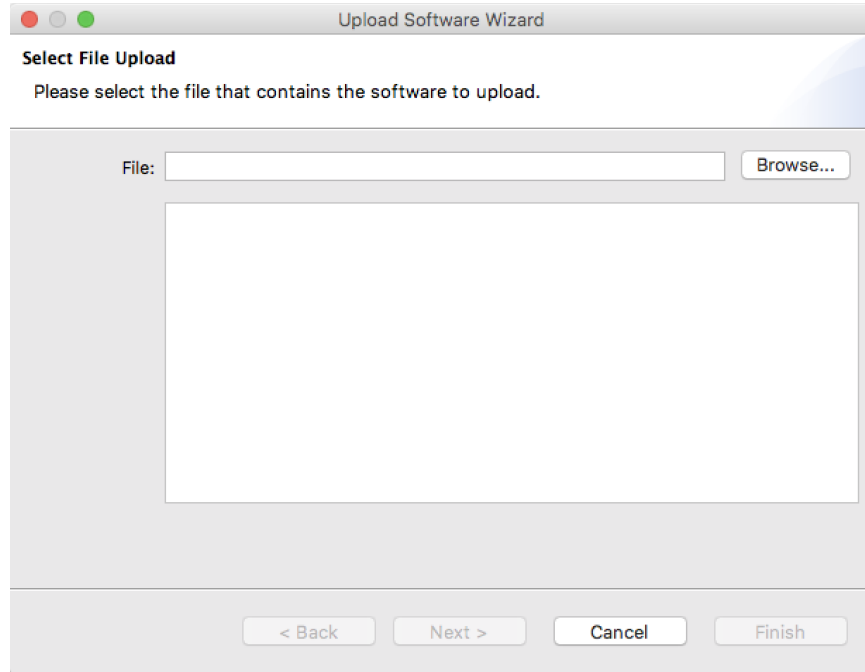

3. From the Upload Software Wizard window, select **Browse**.
4. Navigate to the location of the downloaded .bin file containing the software update. Select the .bin file, then select **Open**. The Upload Software Wizard window displays characteristics of the selected file for uploading.

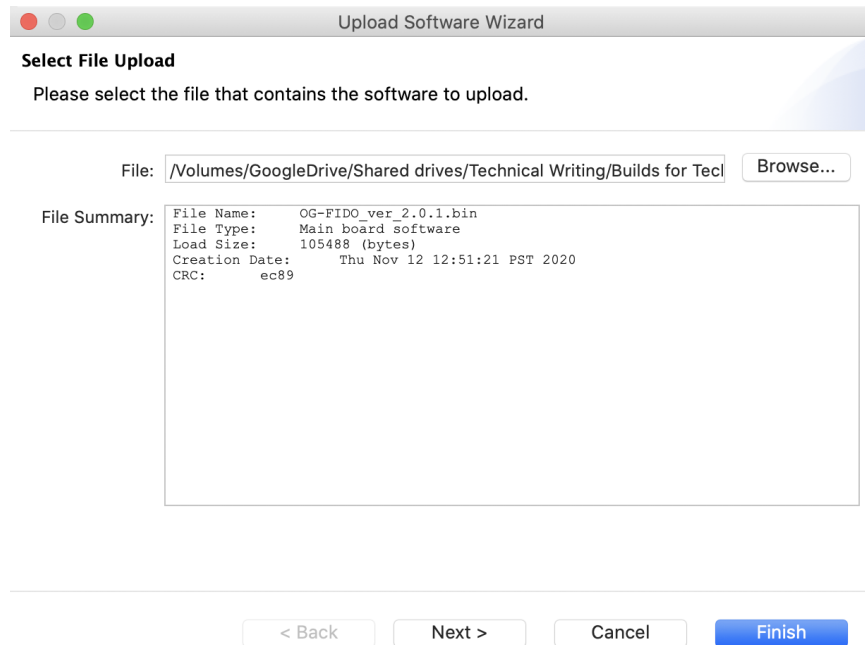

5. Click **Finish**. The uploading process begins.

Figure 18. Uploading to Selected Devices window in DashBoard

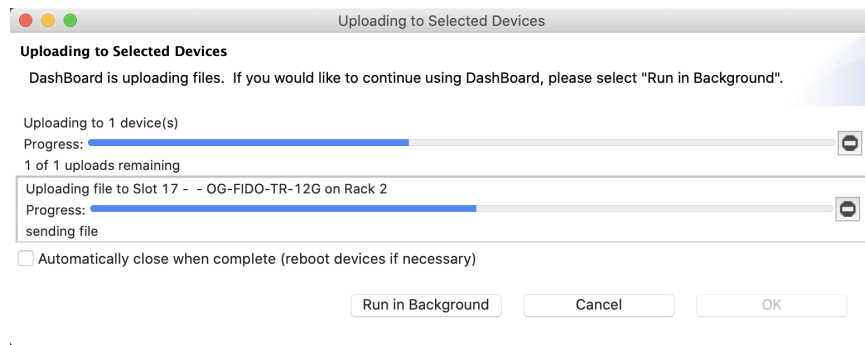

6. When the progress bar indicates that the uploading is finished and status indicates "Complete," click **OK**.

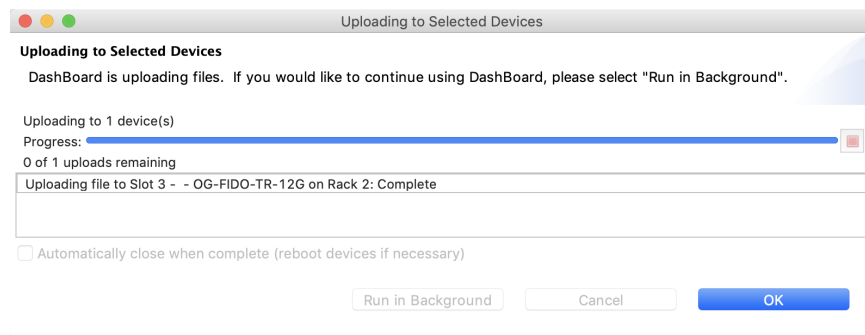

7. To verify the version of software or firmware currently installed on your card, select the Card tab from the center panel of DashBoard.

Figure 19. OG-FiDO-12G Series Card Tab Screen in DashBoard indicating the currently installed software version.

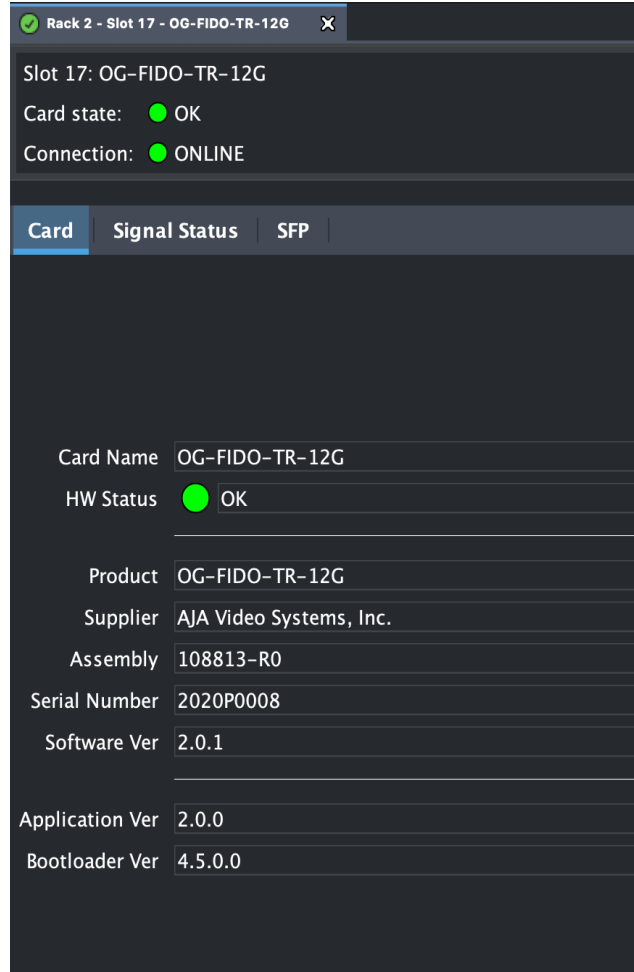

Rebooting

Rebooting is a standard function built in to the DashBoard Control System, and should only be performed if the board has become unresponsive.

To Reboot the OG-FiDO-12G Series

1. Click the Reboot button in the lower panel of DashBoard. The reboot confirmation message displays.

Figure 20. Reboot confirmation window

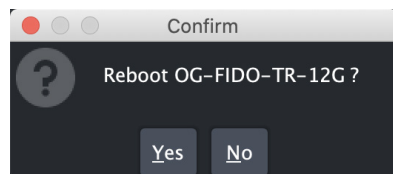

2. Click **Yes**. The message "Loading data, please wait. Refreshing device data" displays for a moment. The card will be offline for a few seconds. However, the video signal will not flicker or go black during a reboot.

Figure 21. The OG-FiDO-12G Series briefly pauses operations while rebooting

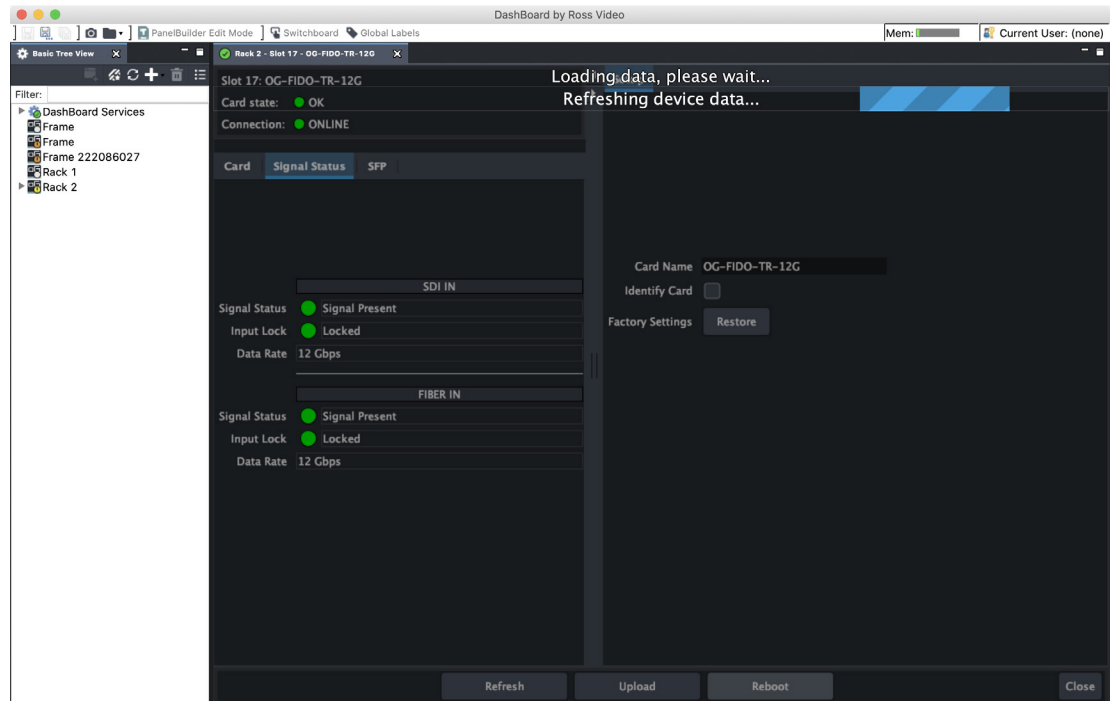

3. Following a Reboot operation, the board configuration will return to the settings that were in place at the time of rebooting.

Appendix A – Specifications

OG-FiDO-TR-12G

Video Formats

- 270Mbps - 12 Gbps, format agnostic

Video Input Digital

- 1-channel independent 12G-SDI BNC connector, SMPTE 259/292/424/2081/2082
- 1-channel independent Single-Mode LC Fiber connector, SMPTE 297/259/292/424/2081/2082
- Nominal Wavelength:
 - Rx 1260 nm (min), 1620 nm (max)
- Optical Sensitivity:
 - -10 dBm (min 6 and 12 Gbps)
 - -14 dBm (min 270 Mbps, 1.5 Gbps and 3 Gbps)
- Overload Power: -2 dBm (min)

Video Output Digital

- 1-channel independent 12G-SDI BNC connector, SMPTE-259/292/424/2081/2082
- 1-channel independent Single Mode LC Fiber connector, SMPTE-297/259/292/424/2081/2082
- Nominal Wavelength: 1260 nm (min), 1310 nm (typ), 1360 nm (max)
- Optical Power: -5 dBm (min), 2 dBm (max)
- Extinction Ratio: 3.5 dB (min)

Reclocking

- 270 Mbps, 1.483 Gbps, 1.485 Gbps, 2.967 Gbps, 2.970 Gbps, 5.934 Gbps, 5.940 Gbps, 11.868 Gbps, 11.880 Gbps - Auto Select
- All other rates are passed through and not reclocked

User Interface

- openGear DashBoard network control software via Windows, macOS or Linux

Size

- openGear standard form factor, front slot and rear card, two slots required for each card

Weight

- 0.5 lb (0.3 kg)

Power

- openGear frame compatible, 3 watts max per card

Environment

- Safe Operating Temperature: 0 to 40 C (32 to 104 F)
- Safe Storage Temperature (Power OFF): -40 to 60 C (-40 to 140 F)

- Operating Relative Humidity: 10-90% noncondensing
- Operating Altitude: <3,000 meters (<10,000 feet)

OG-FiDO-R-12G-ST

Video Formats

- 270Mbps - 12 Gbps, format agnostic

Video Input Digital

- 1-channel Single Mode ST Fiber connector, SMPTE 297/259/292/424/2081/2082
- Nominal Wavelength: 1260 nm (min), 1620 nm (max)
- Optical Sensitivity:
 - -10 dBm (max 6 and 12 Gbps)
 - -14 dBm (max 270 Mbps, 1.5 Gbps and 3 Gbps)
- Overload Power: -2 dBm (min)

Video Output Digital

- 1-channel dual matching 12G-SDI BNC connectors, SMPTE 259/292/424/2081/2082

Reclocking

- 270 Mbps, 1.483 Gbps, 1.485 Gbps, 2.967 Gbps, 2.970 Gbps, 5.934 Gbps, 5.940 Gbps, 11.868 Gbps, 11.880 Gbps - Auto Select
- All other rates are passed through and not reclocked

User Interface

- openGear DashBoard network control software via Windows, macOS or Linux

Size

- openGear standard form factor, front slot and rear card. Two slots required for each card.

Weight

- 0.5 lb (0.3 kg)

Power

- openGear frame compatible, 3 watts max per card

Environment

- Safe Operating Temperature: 0 to 40 C (32 to 104 F)
- Safe Storage Temperature (Power OFF): -40 to 60 C (-40 to 140 F)
- Operating Relative Humidity: 10-90% noncondensing
- Operating Altitude: <3,000 meters (<10,000 feet)

OG-FiDO-2R-12G

Video Formats

- 270Mbps - 12 Gbps, format agnostic

Video Input Digital

- 2-channel independent Single Mode LC Fiber connectors, SMPTE 297/259/292/424/2081/2082
- Nominal Wavelength: 1260 nm (min), 1620 nm (max)
- Optical Sensitivity:
 - -9 dBm (min 12 Gbps)
 - -10 dBm (min 270 Mbps, 1.5 Gbps, 3 Gbps, and 6Gbps)
- Overload Power: -2 dBm (min)

Video Output Digital

- 2-channel independent 12G-SDI BNC Outputs, SMPTE 259/292/424/2081/2082

Reclocking

- 270 Mbps, 1.483 Gbps, 1.485 Gbps, 2.967 Gbps, 2.970 Gbps, 5.934 Gbps, 5.940 Gbps, 11.868 Gbps, 11.880 Gbps - Auto Select
- All other rates are passed through and not reclocked

User Interface

- openGear DashBoard network control software via Windows, macOS or Linux

Size

- openGear standard form factor, front slot and rear card. Two slots required for each card

Weight

- 0.5 lb (0.3 kg)

Power

- openGear frame compatible, 3 watts max per card

Environment

- Safe Operating Temperature: 0 to 40 C (32 to 104 F)
- Safe Storage Temperature (Power OFF): -40 to 60 C (-40 to 140 F)
- Operating Relative Humidity: 10-90% noncondensing
- Operating Altitude: <3,000 meters (<10,000 feet)

Appendix B – Safety and Compliance

Federal Communications Commission (FCC) Compliance Notices

Class A Interference Statement

This equipment has been tested and found to comply with the limits for a Class A digital device, pursuant to Part 15, Subpart B of the FCC Rules. These limits are designed to provide reasonable protection against harmful interference in a residential installation. This equipment generates, uses, and can radiate radio frequency energy and, if not installed and used in accordance with the instructions, may cause harmful interference to radio communications. However, there is no guarantee that interference will not occur in a particular installation. If this equipment does cause harmful interference to radio or television reception, which can be determined by turning the equipment off and on, the user is encouraged to try to correct the interference by one or more of the following measures:

- Reorient or relocate the receiving antenna.
- Increase the separation between the equipment and receiver.
- Connect the equipment into an outlet on a circuit different from that to which the receiver is connected.
- Consult the dealer or an experienced radio/TV technician for help.

FCC Caution

This device complies with Part 15 of the FCC Rules. Operation is subject to the following two conditions: (1) This device may not cause harmful interference, and (2) this device must accept any interference received, including interference that may cause undesired operation.

Canadian ICES Statement

Canadian Department of Communications Radio Interference Regulations

This digital apparatus does not exceed the Class A limits for radio-noise emissions from a digital apparatus as set out in the Radio Interference Regulations of the Canadian Department of Communications. This Class A digital apparatus complies with Canadian ICES-003.

Règlement sur le brouillage radioélectrique du ministère des Communications

Cet appareil numérique respecte les limites de bruits radioélectriques visant les appareils numériques de classe A prescrites dans le Règlement sur le brouillage radioélectrique du ministère des Communications du Canada. Cet appareil numérique de la Classe A est conforme à la norme NMB-003 du Canada.

European Union and European Free Trade Association (EFTA) Regulatory Compliance

This equipment may be operated in the countries that comprise the member countries of the European Union and the European Free Trade Association. These countries, listed in the following paragraph, are referred to as The European Community throughout this document:

AUSTRIA, BELGIUM, BULGARIA, CYPRUS, CZECH REPUBLIC, DENMARK, ESTONIA, FINLAND, FRANCE, GERMANY, GREECE, HUNGARY, IRELAND, ITALY, LATVIA, LITHUANIA, LUXEMBOURG, MALTA, NETHERLANDS, POLAND, PORTUGAL, ROMANIA, SLOVAKIA, SLOVENIA, SPAIN, SWEDEN, UNITED KINGDOM, ICELAND, LICHTENSTEIN, NORWAY, SWITZERLAND

Declaration of Conformity

Marking by this symbol indicates compliance with the Essential Requirements of the EMC Directive of the European Union 2014/30/EU.



This equipment meets the following conformance standards:

EN 62368-1: 2014 + A11 (T-Mark License),

IEC 62368-1: 2014; (CB Scheme Certificate)

Additional licenses issued for specific countries available on request.

Emissions

EN 55032: 2015 + A11: 2020, CISPR 32: 2015,

EN 61000-3-2: 2014, EN 61000-3-3: 2013

Immunity

EN 55103-2: 2009, EN 61000-4-2:2009, EN 61000-4-3: 2006 + A1:2008 + A2:2010,

EN 61000-4-4: 2012, EN 61000-4-5: 2014 + A1: 2017, EN 61000-4-6: 2013,

EN 61000-4-11: 2020

Environments: E2, E3 and E4

The product is also licensed for additional country specific standards as required for the International Marketplace.

Laser

EN 60825-1: 2014 and EN 60825-2: 2004 + A1 + A2,

CDRH Compliant Class 1 (TUV Cert No's. R 50408760 & JPTUV-117245)

Also Licensed for Standards: FDA 21 CFR 1040.10 and 1040.11



Warning! This is a Class A product. In a domestic environment, this product may cause radio interference, in which case, the user may be required to take appropriate measures.

Achtung! Dieses ist ein Gerät der Funkstörgrenzwertklasse A. In Wohnbereichen können bei Betrieb dieses Gerätes Rundfunkstörungen auftreten, in welchen Fällen der Benutzer für entsprechende Gegenmaßnahmen verantwortlich ist.

Attention! Ceci est un produit de Classe A. Dans un environnement domestique, ce produit risque de créer des interférences radioélectriques, il appartiendra alors à l'utilisateur de prendre les mesures spécifiques appropriées..

Recycling Notice



This symbol on the product or its packaging indicates that this product must not be disposed of with your other household waste. Instead, it is your responsibility to dispose of your waste equipment by handing it over to a designated collection point for the recycling of waste electrical and electronic equipment. The separate collection and recycling of your waste equipment at the time of disposal will help conserve natural resources and ensure that it is recycled in a manner that protects human health and the environment. For more information about where you can drop off your waste for recycling, please contact your local authority, or where you purchased your product.

Korea KCC Compliance Statement

사용자안내문

이 기기는 업무용 환경에서 사용할 목적으로 적합성평가를 받은 기기로서 가정용 환경에서 사용하는 경우 전파간섭의 우려가 있습니다.

Taiwan Compliance Statement

警告使用者：
這是甲類的資訊產品，在居住的環境中使用時，可能會造成射頻干擾，在這種情況下，使用者會被要求採取某些適當的對策。

This is a Class A product based on the standard of the Bureau of Standards, Metrology and Inspection (BSMI) CNS 13438, Class A. In a domestic environment this product may cause radio interference in which case the user may be required to take adequate measures.

Japanese Compliance Statement

この装置は、クラスA情報技術装置です。この装置を家庭環境で使用すると電波妨害を引き起こすことがあります。この場合には使用者が適切な対策を講ずるよう要求されることがあります。 VCCI-A

This is a Class A product based on the standard of the VCCI Council (VCCI-32: 2016). If this equipment is used in a domestic environment, radio interference may occur, in which case, the user may be required to take corrective actions.

Translated Warning and Caution Messages

The following caution statements, warning conventions, and warning messages apply to this product and manual.



Warning Symbol



Hazard Symbol



Caution Symbol

Before Operation Please Read These Instructions



Warning! Read and follow all warning notices and instructions marked on the product or included in the documentation.

Avertissement! Lisez et conformez-vous à tous les avis et instructions d'avertissement indiqués sur le produit ou dans la documentation.

Warnung! Lesen und befolgen Sie die Warnhinweise und Anweisungen, die auf dem Produkt angebracht oder in der Dokumentation enthalten sind.

¡Advertencia! Lea y siga todas las instrucciones y advertencias marcadas en el producto o incluidas en la documentación.

Aviso! Leia e siga todos os avisos e instruções assinalados no produto ou incluídos na documentação.

Avviso! Leggere e seguire tutti gli avvisi e le istruzioni presenti sul prodotto o inclusi nella documentazione.



Warning! Do not use this device near water and clean only with a dry cloth.

Avertissement! N'utilisez pas cet appareil près de l'eau et nettoyez-le seulement avec un tissu sec.

Warnung! Das Gerät nicht in der Nähe von Wasser verwenden und nur mit einem trockenen Tuch säubern.

¡Advertencia! No utilice este dispositivo cerca del agua y límpielo solamente con un paño seco.

Aviso! Não utilize este dispositivo perto da água e limpe-o somente com um pano seco.

Avviso! Non utilizzare questo dispositivo vicino all'acqua e pulirlo soltanto con un panno asciutto.



Warning! Do not block any ventilation openings. Install in accordance with the manufacturer's instructions.

Avertissement! Ne bloquez aucune ouverture de ventilation. Suivez les instructions du fabricant lors de l'installation.

Warnung! Die Lüftungsöffnungen dürfen nicht blockiert werden. Nur gemäß den Anweisungen des Herstellers installieren.

¡Advertencia! No bloquee ninguna de las aberturas de la ventilación. Instale de acuerdo con las instrucciones del fabricante.

Aviso! Não obstrua nenhuma das aberturas de ventilação. Instale de acordo com as instruções do fabricante.

Avviso! Non ostruire le aperture di ventilazione. Installare in conformità con le istruzioni del fornitore.



Warning! Do not install near any heat sources such as radiators, heat registers, stoves, or other apparatus (including amplifiers) that produce heat.

Avertissement! N'installez pas l'appareil près d'une source de chaleur telle que des radiateurs, des bouches d'air de chauffage, des fourneaux ou d'autres appareils (amplificateurs compris) qui produisent de la chaleur.

Warnung! Nicht in der Nähe von Wärmequellen wie Heizkörpern, Heizregistern, Öfen oder anderen Wärme erzeugenden Geräten (einschließlich Verstärkern) aufstellen.

¡Advertencia! No instale cerca de fuentes de calor tales como radiadores, registros de calor, estufas u otros aparatos (incluidos amplificadores) que generan calor.

Aviso! Não instale perto de nenhuma fonte de calor tal como radiadores, saídas de calor, fogões ou outros aparelhos (incluindo amplificadores) que produzam calor.

Avviso! Non installare vicino a fonti di calore come termosifoni, diffusori di aria calda, stufe o altri apparecchi (amplificatori compresi) che emettono calore



Warning! Do not defeat the safety purpose of the polarized or grounding-type plug. A polarized plug has two blades with one wider than the other. A grounding type plug has two blades and a third grounding prong. The wide blade or the third prong are provided for your safety. If the provided plug does not fit into your outlet, consult an electrician for replacement of the obsolete outlet.

Avertissement! La sécurité de la prise polarisée ou de la prise de type mise à la terre ne doit en aucun cas être empêchée de fonctionner. Une prise polarisée a deux broches, l'une étant plus large que l'autre. Une prise de type mise à la terre a deux broches et une troisième broche pour la mise à la terre. La broche large ou la troisième broche sont fournies pour votre sécurité. Si la prise fournie ne s'insère pas dans votre prise femelle, consultez un électricien pour le remplacement de la prise femelle obsolète.

Warnung! Der Sicherheitszweck des gepolten bzw. Schukosteckers ist zu berücksichtigen. Ein gepolter Stecker verfügt über zwei Pole, von denen einer breiter als der andere ist. Ein Schukostecker verfügt neben den zwei Polen noch über einen dritten Pol zur Erdung. Der breite Pol bzw. der Erdungspol dienen der Sicherheit. Wenn der zur Verfügung gestellte Stecker nicht in Ihren Anschluss passt, konsultieren Sie einen Elektriker, um den veralteten Anschluss zu ersetzen.

¡Advertencia! No eche por tierra la finalidad del tipo de enchufe polarizado con conexión a tierra. Un enchufe polarizado tiene dos espigas, una más ancha que la otra. Un enchufe con conexión a tierra tiene dos espigas iguales y una tercera espiga que sirve para la conexión a tierra. La espiga ancha, o la tercera espiga, sirven para su seguridad. Si el enchufe suministrado no encaja en el tomacorriente, consulte con un electricista para reemplazar el tomacorriente obsoleto.

Aviso! Não anule a finalidade da segurança da ficha polarizada ou do tipo ligação terra. Uma ficha polarizada tem duas lâminas sendo uma mais larga do que a outra. Uma ficha do tipo de ligação à terra tem duas lâminas e um terceiro terminal de ligação à terra. A lâmina larga ou o terceiro terminal são fornecidos para sua segurança. Se a ficha fornecida não couber na sua tomada, consulte um electricista para a substituição da tomada obsoleta.

Avviso! Non compromettere la sicurezza della spina polarizzata o con messa a terra. Una spina polarizzata ha due spinotti, di cui uno più largo. Una spina con messa a terra ha due spinotti e un terzo polo per la messa a terra. Lo spinotto largo o il terzo polo sono forniti per motivi di sicurezza. Se la spina fornita non si inserisce nella presa di corrente, contattare un elettricista per la sostituzione della presa obsoleta.



Warning! Since the Mains plug is used as the disconnection for the device, it must remain readily accessible and operable.

Avertissement! Puisque la prise principale est utilisée pour débrancher l'appareil, elle doit rester aisément accessible et fonctionnelle.

Warnung! Da der Netzstecker als Trennvorrichtung dient, muss er stets zugänglich und funktionsfähig sein.

¡Advertencia! Puesto que el enchufe de la red eléctrica se utiliza como dispositivo de desconexión, debe seguir siendo fácilmente accesible y operable.

Aviso! Dado que a ficha principal é utilizada como a desconexão para o dispositivo, esta deve manter-se prontamente acessível e funcional.

Avviso! Poiché il cavo di alimentazione viene usato come dispositivo di sconnessione, deve rimanere prontamente accessibile e operabile.



Warning! Protect the power cord from being walked on or pinched particularly at plugs, convenience receptacles, and the point where they exit from the device.

Avertissement! Protégez le cordon d'alimentation pour que l'on ne marche pas dessus ou qu'on le pince, en particulier au niveau des prises mâles, des réceptacles de convenance, et à l'endroit où il sort de l'appareil.

Warnung! Vermeiden Sie, dass auf das Netzkabel getreten oder das Kabel geknickt wird, insbesondere an den Steckern, den Steckdosen und am Kabelausgang am Gerät.

¡Advertencia! Proteja el cable de energía para que no se le pise ni apriete, en especial cerca del enchufe, los receptáculos de conveniencia y el punto del que salen del equipo.

Aviso! Proteja o cabo de alimentação de ser pisado ou de ser comprimido particularmente nas fichas, em tomadas de parede de conveniência e no ponto de onde sai do dispositivo.

Avviso! Proteggere il cavo di alimentazione in modo che nessuno ci cammini sopra e che non venga schiacciato soprattutto in corrispondenza delle spine e del punto in cui esce dal dispositivo.



Warning! Unplug this device during lightning storms or when unused for long periods of time.

Avertissement! Débranchez cet appareil pendant les orages avec éclairsou s'il est inutilisé pendant de longues périodes.

Warnung! Das Gerät ist bei Gewitterstürmen oder wenn es über lange Zeiträume ungenutzt bleibt vom Netz zu trennen.

¡Advertencia! Desenchufe este dispositivo durante tormentas eléctricas o cuando no se lo utilice por largos periodos del tiempo.

Aviso! Desconecte este dispositivo da tomada durante trovoadas ou quando não é utilizado durante longos períodos de tempo.

Avviso! Utilizzare soltanto i collegamenti e gli accessori specificati e/o venduti dal produttore, quali il treppiedi e l'esoscheletro.



Warning! Refer all servicing to qualified service personnel. Servicing is required when the device has been damaged in any way, such as power-supply cord or plug is damaged, liquid has been spilled or objects have fallen into the device, the device has been exposed to rain or moisture, does not operate normally, or has been dropped.

Avertissement! Référez-vous au personnel de service qualifié pour tout entretien. L'entretien est exigé quand l'appareil a été endommagé de quelque manière que ce soit, par exemple lorsque le cordon d'alimentation ou la prise sont endommagés, que du liquide a été versé ou des objets sont tombés dans l'appareil, que l'appareil a été exposé à la pluie ou à l'humidité, ne fonctionne pas normalement ou est tombé.

Warnung! Das Gerät sollte nur von qualifizierten Fachkräften gewartet werden. Eine Wartung ist fällig, wenn das Gerät in irgendeiner Weise beschädigt wurde, wie bei beschädigtem Netzkabel oder Netzstecker, falls Flüssigkeiten oder Objekte in das Gerät gelangen, das Gerät Regen oder Feuchtigkeit ausgesetzt wurde, nicht ordnungsgemäß funktioniert oder fallen gelassen wurde.

¡Advertencia! Consulte al personal calificado por cuestiones de reparación. El servicio de reparación se requiere cuando el dispositivo ha recibido cualquier tipo de daño, por ejemplo cable o espigas dañadas, se ha derramado líquido o se han caído objetos dentro del dispositivo, el dispositivo ha sido expuesto a la lluvia o humedad, o no funciona de modo normal, o se ha caído.

Aviso! Remeta todos os serviços de manutenção para o pessoal de assistência qualificado. A prestação de serviços de manutenção é exigida quando o dispositivo foi danificado mediante qualquer forma, como um cabo de alimentação ou ficha que se encontra danificado/a, quando foi derramado líquido ou caíram objectos sobre o dispositivo, quando o dispositivo foi exposto à chuva ou à humidade, quando não funciona normalmente ou quando foi deixado cair.

Avviso! Fare riferimento al personale qualificato per tutti gli interventi di assistenza. L'assistenza è necessaria quando il dispositivo è stato danneggiato in qualche modo, ad esempio se il cavo di alimentazione o la spina sono danneggiati, è stato rovesciato del liquido è stato rovesciato o qualche oggetto è caduto nel dispositivo, il dispositivo è stato esposto a pioggia o umidità, non funziona correttamente o è caduto



Warning! Do not open the chassis. There are no user-serviceable parts inside. Opening the chassis will void the warranty unless performed by an AJA service center or licensed facility.

Avertissement! Ne pas ouvrir le châssis. Aucun élément à l'intérieur du châssis ne peut être réparé par l'utilisateur. La garantie sera annulée si le châssis est ouvert par toute autre personne qu'un technicien d'un centre de service ou d'un établissement agréé AJA.

Warnung! Öffnen Sie das Gehäuse nicht. Keine der Geräteteile können vom Benutzer gewartet werden. Durch das Öffnen des Gehäuses wird die Garantie hinfällig, es sei denn, solche Wartungsarbeiten werden in einem AJA-Service-Center oder einem lizenzierten Betrieb vorgenommen.

¡Advertencia! No abra el chasis. El interior no contiene piezas reparables por el usuario. El abrir el chasis anulará la garantía a menos que se lo haga en un centro de servicio AJA o en un local autorizado.

Advertência! Não abra o chassi. Não há internamente nenhuma peça que permita manutenção pelo usuário. Abrir o chassi anula a garantia, a menos que a abertura seja realizada por uma central de serviços da AJA ou por um local autorizado.

Avvertenza! Non aprire lo chassis. All'interno non ci sono parti riparabili dall'utente. L'apertura dello chassis invaliderà la garanzia se non viene effettuata da un centro ufficiale o autorizzato AJA.



Warning! Disconnect the external AC power supply line cord(s) from the mains power before moving the unit.

Avertissement! Retirez le ou les cordons d'alimentation en CA de la source d'alimentation principale lorsque vous déplacez l'appareil.

Warnung! Trennen Sie die Wechselstrom-Versorgungskabel vom Netzstrom, bevor Sie das Gerät verschieben.

¡Advertencia! Cuando mueva la unidad desenchufe de la red eléctrica el/los cable(s) de la fuente de alimentación CA tipo brick.

Advertência! Remova os cabos CA de alimentação brick da rede elétrica ao mover a unidade.

Avvertenza! Scollegare il cavo dell'alimentatore quando si sposta l'unità.



Warning! Only use attachments and accessories specified and/or sold by the manufacturer.

Avertissement! Utilisez seulement les attaches et accessoires spécifiés et/ou vendus par le fabricant.

Warnung! Verwenden Sie nur Zusatzgeräte und Zubehör angegeben und / oder verkauft wurde durch den Hersteller.

¡Advertencia! Utilice solamente los accesorios y conexiones especificados y/o vendidos por el fabricante.

Aviso! Utilize apenas equipamentos/acessórios especificados e/ou vendidos pelo fabricante.

Avviso! Utilizzare soltanto i collegamenti e gli accessori specificati e/o venduti dal produttore.



Warning! Active fiber-optic cables emit radiation invisible to the human eye. Do not look directly at the end of an active fiber-optic cable or the fiber connector on an OG-FiDO-TR-12G; these models are Class 1 Laser Products.

Avertissement! Les câbles fibre optique émettent des radiations invisibles à l'œil humain. Ne regardez pas directement l'extrémité d'un câble fibre optique ou d'un connecteur de fibre d'un OG-FiDO-TR-12G; ces modèles sont des produits laser de Classe 1.

Warnung! Glasfaserkabel emittieren im Betrieb Strahlung, die für das menschliche Auge unsichtbar ist. Nicht direkt in das Ende eines im Betrieb befindlichen Glasfaserkabels bzw. den Glasfaserkabelanschluss am OG-FiDO-TR-12G schauen; diese Modelle sind Lasergeräte der Klasse 1.

¡Advertencia! Los cables de fibra óptica activos emiten radiación invisible al ojo humano. No mire directamente hacia el extremo de un cable de fibra óptica activo o hacia el conector de fibra óptica del OG-FiDO-TR-12G; estos modelos están clasificados como Productos Láser Clase 1.

Advertência! Os cabos de fibra óptica emitem radiação invisível para o olho humano. Não olhe diretamente para a extremidade de um cabo de fibra óptica ativo ou para o conector da fibra em um OG-FiDO-TR-12G; esses modelos são Produtos de Laser Classe 1.

Avvertenza! I cavi a fibre ottiche emettono radiazioni invisibili all'occhio umano. Non guardare direttamente l'estremità di un cavo in fibra ottica attivo o il connettore in fibra su un OG-FiDO-TR-12G; questi modelli sono prodotti laser di classe 1.



Warning! Ensure Mains Power is disconnected before installing the OG-FIDO-12G Series modules into the frame, or installing and removing options. If a Mains switch is not provided, the power cord(s) of this equipment provide the means of disconnection. The socket outlet must be installed near the equipment and must be easily accessible.

Avertissement ! Avant d'installer des modules OG-FIDO-12G Series dans la structure, ainsi qu'avant d'installer ou d'enlever des options, assurez-vous d'avoir déconnecté l'alimentation électrique. S'il n'y a pas d'interrupteur électrique, il faut débrancher les câbles électriques de l'équipement. La prise électrique doit être située à proximité de l'équipement et doit être aisément accessible.

Achtung! Sicherstellen, dass die Netzleitung entkoppelt ist, bevor die OG-FIDO-12G Series Module in das Gestell eingebaut oder Wahlteile eingebaut bzw. ausgebaut werden. Wenn kein Netzschalter vorgesehen ist, dient das bzw. dienen die Netzkabel dieser Vorrichtung als Entkopplungsmittel. Die Steckdose muss in der Nähe der Vorrichtung installiert und leicht zugänglich sein.

Avvertenza. Accertarsi che l'alimentazione di rete sia scollegata prima di installare i moduli OG-FIDO-12G Series nel frame o di installare e rimuovere componenti opzionali. Se non è presente un interruttore di accensione/spengimento, occorre scollegare il cavo (o i cavi) di alimentazione di questo apparecchio dalla presa di corrente. La presa di corrente deve essere situata presso l'apparecchio e facilmente accessibile.

Aviso! Certifique-se que a fonte principal de energia elétrica está desconectada antes de instalar os módulos OG-FIDO-12G Series no bastidor ou antes de instalar e remover opções. Se o interruptor principal não existir, o cabo elétrico deste equipamento proporciona o meio de desconexão. A tomada elétrica deverá ser instalada perto do equipamento e deverá ser de fácil acesso.

¡Advertencia! Asegúrese que la red de alimentación está desconectada antes de instalar los módulos OG-FIDO-12G Series en el marco, o la instalación y extracción de opciones. Si no se proporciona un conmutador de red, el cable de alimentación de este equipo proporciona los medios de desconexión. El zócalo tomacorriente debe estar instalado cerca del equipo y debe ser fácilmente accesible.



Warning! Dual Power Cord Notice—please read this. To reduce the risk of electrical shock, disconnect both power cords before servicing equipment.

Avertissement ! Avis concernant la double alimentation électrique—à lire soigneusement. Pour éviter tout risque d'électrocution, débranchez les deux câbles électriques avant d'intervenir sur l'équipement.

Achtung! Hinweis auf Doppel-Netzkabel-bitte lesen. Um das Risiko eines Elektroschocks zu verringern, müssen beide Netzkabel ausgestöpselt werden, bevor die Vorrichtung gewartet wird.

Avvertenza. Avviso concernente il cavo di alimentazione doppio - leggere attentamente. Per ridurre il rischio di elettrocuzione, scollegare entrambi i cavi di alimentazione prima di eseguire la manutenzione o riparazioni di questo apparecchio.

Aviso! Aviso de Cabo Elétrico Duplo - por favor, leia isto. Para reduzir o risco de choque elétrico, desconecte ambos os cabos elétricos antes de fazer manutenção ao equipamento.

¡Advertencia! Aviso del doble cable de alimentación - leer esto por favor. Para reducir el riesgo de descarga eléctrica, desconecte ambos cables de alimentación antes de dar servicio al equipo.



Caution! The OG-X-FR front fan door is heavy. Remove with Caution.

Attention! La porte du ventilateur avant OG-X-FR est lourde. Retirer avec précaution.

Achtung! Die OG-X-FR -Frontlüfter Tür ist schwer. Bitte vorsichtig entfernen.

¡Precaución! La puerta del ventilador frontal OG-X-FR es pesado. Extraer con precaución.

Atenção! A porta do ventilador frontal OG-X-FR é pesado. Remova com cuidado.

Attenzione! La porta ventola anteriore OG-X-FR è pesante. Rimuovere con cautela.



Hazard! High Voltage. This situation or condition can cause injury due to electric shock.

Avertissement! Tension élevée. Cette situation ou condition peut causer des blessures dues à un choc électrique.

Warnung! Hochspannung. Diese Situation oder Bedingung kann zu Verletzungen durch Stromschlag führen.

¡Advertencia! Alto voltaje . Esta situación o condición puede causar lesiones debidas a una descarga eléctrica.

Aviso! Alta Tensão . Esta situação ou condição pode causar danos devido a choques elétricos.

Avviso! Alta tensione. Questa situazione o condizione può causare lesioni a causa di scosse elettriche.



Caution! To meet safety regulations for leakage current, connect the dual power supplies to separate branch circuits.

¡Advertencia! Para cumplir con las normas de seguridad para la corriente de fuga, conecte las dos fuentes de alimentación para circuitos derivados diferentes.

Attention! Pour répondre aux mesures de sécurité concernant le courant de fuite, raccorder les sources d'alimentation doubles à des circuits de dérivation distincts.

Warnung! Zur Erfüllung der Sicherheitsbestimmungen bezüglich Reststrom schließen Sie bitte die zwei Netzteile an unterschiedlichen Abzweigungen an.

Cuidado! Para atender aos regulamentos de segurança para correntes de fuga, conecte as fontes duplas a circuitos elétricos separados.

Attenzione! Per soddisfare le norme di sicurezza sulla corrente di perdita, collegare i doppi alimentatori a circuiti derivati separati.

Warranty and Liability Information

Limited Warranty on Hardware

AJA Video Systems, Inc. (AJA Video) warrants that the hardware product, not including software components, will be free from defects in materials and workmanship for a period of five years from the date of purchase. AJA Video provides a separate software warranty as part of the license agreement applicable to software components.

If the Customer brings a valid claim under this limited warranty for a hardware product (hereafter, a “product”) during the applicable warranty period, AJA Video will, at its sole option and as the Customer’s sole remedy for breach of the above warranty, provide one of the following remedies:

- Repair or facilitate the repair the product within a reasonable period of time, free of charge for parts and labor.
- Replace the product with a direct replacement or with a product that performs substantially the same function as the original product.
- Issue a refund of the original purchase price less depreciation to be determined based on the age of the product at the time remedy is sought under this limited warranty.

To obtain service under this warranty, the Customer must notify AJA Video of the defect before expiration of the warranty period and make suitable arrangements for the performance of service by contacting AJA Video support through the channels set forth on the support contacts web page at <https://www.aja.com/support>. Except as stated, the Customer shall bear all shipping, packing, insurance and other costs, excluding parts and labor, to effectuate repair. Customer shall pack and ship the defective product to a service center designated by AJA Video, with shipping charges prepaid. AJA Video shall pay to return the product to Customer, but only if to a location within the country in which the AJA Video service center is located. SOME JURISDICTIONS DO NOT ALLOW THE EXCLUSION OF IMPLIED WARRANTIES OR LIMITATIONS ON APPLICABLE STATUTORY RIGHTS OF A CONSUMER, SO SOME OR ALL OF THE TERMS OF THIS PARAGRAPH MAY NOT APPLY TO YOU.

Limitation of Liability

Under no circumstances shall AJA video BE LIABLE IN ANY WAY FOR ANY LOST, CORRUPTED OR DESTROYED DATA, FOOTAGE OR WORK, OR FOR ANY OTHER INDIRECT, SPECIAL, INCIDENTAL OR CONSEQUENTIAL DAMAGES OR LOST PROFITS, OR FOR ANY THIRD PARTY CLAIM, IN CONNECTION WITH THE PRODUCT, WHETHER RESULTING FROM DEFECTS IN THE PRODUCT, SOFTWARE OR HARDWARE FAILURE, OR ANY OTHER CAUSE WHATSOEVER, EVEN IF AJA VIDEO HAS BEEN ADVISED OF THE POSSIBILITY OF SUCH DAMAGES. AJA VIDEO’S LIABILITY IN CONNECTION WITH THE PRODUCT SHALL UNDER NO CIRCUMSTANCES EXCEED THE PURCHASE PRICE PAID FOR THE PRODUCT. The foregoing limitations apply even if any remedy set forth in this LIMITED WARRANTY fails of its essential purpose. SOME JURISDICTIONS DO NOT ALLOW THE LIMITATION OF LIABILITY FOR PERSONAL INJURY, OR OF INCIDENTAL OR CONSEQUENTIAL DAMAGES, SO SOME OR ALL OF THE TERMS OF THIS PARAGRAPH MAY NOT APPLY TO YOU.

Governing Law and Language; Your Rights

This limited warranty is the only warranty provided by AJA Video on the hardware product. It supersedes all prior or contemporaneous understandings regarding such subject matter. No amendment to or modification of this warranty will be binding unless in writing and signed by AJA Video. The laws of the State of California, USA will govern this warranty and any dispute arising from it. Any translation of this Agreement is intended for convenience and to meet local requirements and in the

event of a dispute between the English and any non-English versions, the English version of this warranty will govern. This limited warranty gives you specific legal rights and you may have other rights that vary from jurisdiction to jurisdiction, some of which are noted above.