



ADDERLink™ XD612 and XD614

User Guide



Introduction

Welcome	2
Multi-display support using MST	3
AdderLink XD612 features	5
AdderLink XD614 features	6
Technical specifications	7
Supplied items	8
Optional extras	9

Installation

Locations	10
Connections	10
Transmitter video link(s)	11
Transmitter audio links	11
Transmitter USB links	12
Transmitter Remote port	12
Transmitter power connection	13
Linking	14
CATx link	14
Fiber optic link	15
Receiver video display(s)	16
EDID management	16
Receiver audio devices	16
Receiver USB devices	17
Receiver Remote port	17
Receiver power connection	18

Configuration

Accessing the Dashboard	19
Choosing RX video mode (XD614 models only)	19
Resetting a module	20
Upgrading Firmware	20

Operation

Indicators	21
------------------	----

Further information

Getting assistance	22
Appendix I - Remote port pin-out	23

Index

Introduction



WELCOME

Thank you for choosing the ADDERLink® XD612 (dual head) or XD614 (quad head) extender modules. Using either fiber optic or CATx links, these compact modules allow you to extend KVM connections over long distances from a host computer (see *Transmission distances when using fiber* on the right).

The high-grade screening employed within the metal cased enclosures, particularly when combined with the immunity from interference of the fiber optic links.

AdderLink XD extender modules provide support for:

- High quality single-, dual-, triple- or quad- digital video
- Video resolutions up to 4K 4096 x 2160 @60Hz (XD614 models),
- USB keyboard and mouse plus two other USB devices (up to USB 2.0),
- An RS232 serial device at speeds up to 115200 baud,
- Mono microphone,
- Stereo speakers, digital stereo audio out
- Line-level audio in/out connections.

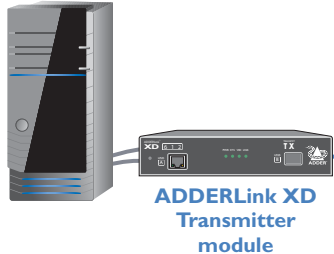

The ADDERLink extender modules are totally transparent in operation, leaving you free to use your computer as though you're still sitting next to it.

Fiber optic link
(up to 4km)
OR
CATx link
(CAT5e up to 50m)
(CAT6 up to 100m)

Transmission distances when using fiber

The choice of fiber used with the ADDERLink XD modules has a considerable effect on the distance over which operation can take place. Using multi-mode fiber you can achieve distances up to 400m (1,312 feet); whereas, by using single-mode fiber (and accompanying SFP+ modules), the achievable maximum distance is increased to 4km (2.5 miles):

Distance	Fiber type	Fiber color code	SFP+ module
70m	OM1 (TIA-492AAAA)	Orange	SFP+-MM-LC-10G
150m	OM2 (TIA-492AAAB)	Orange	SFP+-MM-LC-10G
380m	OM3 (TIA-492AAAC)	Aqua	SFP+-MM-LC-10G
400m	OM4 (TIA-492AAAC)	Aqua	SFP+-MM-LC-10G
4km	OS1 (TIA-492C000)	Yellow	SFP+-SM-LC-10G
	OS2 (TIA-492E000)	Yellow	SFP+-SM-LC-10G

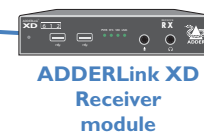
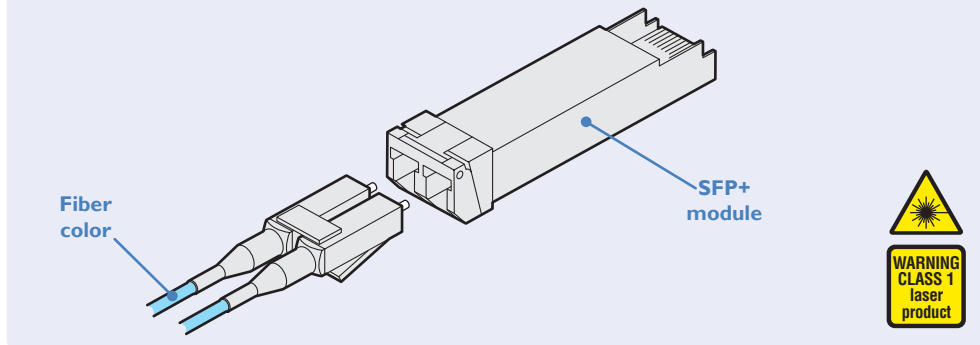

Up to 4 DisplayPort® video displays (see page 3)
Four USB devices
One RS232 serial devices
Stereo speakers plus microphone

INSTALLATION

CONFIGURATION

OPERATION

FURTHER INFORMATION

INDEX

MULTI-DISPLAY SUPPORT USING MST

The ADDERLink XD612 and 614 models support the MST (Multi-Stream Transport) protocol, which was introduced in the DisplayPort 1.2 standard. MST allows feeds for multiple video displays to be fed along a single cable. The XD612 and XD614 models use this feature in different ways.

ADDERLink XD612 models use a single DisplayPort link to accept up to two video feeds from the host computer. This combined MST stream is then transferred to the receiver where an internal MST hub separates the two streams and presents them individually at the two video output ports.

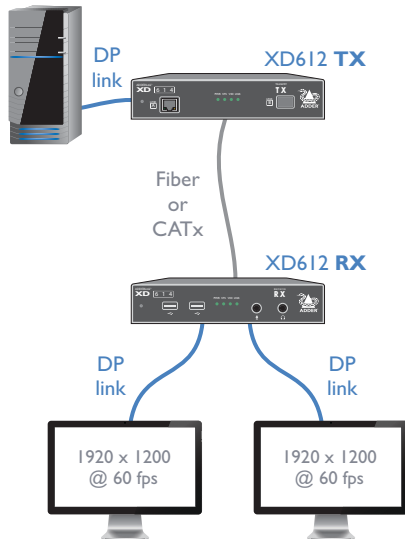

The video displays do not need to be MST-compliant and no hub is required.

Notes:

When using more than one video display, the host's video adapter, operating system and applications must all support MST.

Windows™ and Linux fully support MST, however, no devices manufactured by Apple® currently support it.

ADDERLink XD614 models use a single DisplayPort link to accept up to four video streams from the host computer. This combined MST stream is then transferred to the receiver, where you can connect multiple video displays in a daisy-chain (or via a third-party MST hub) from the primary video output port:

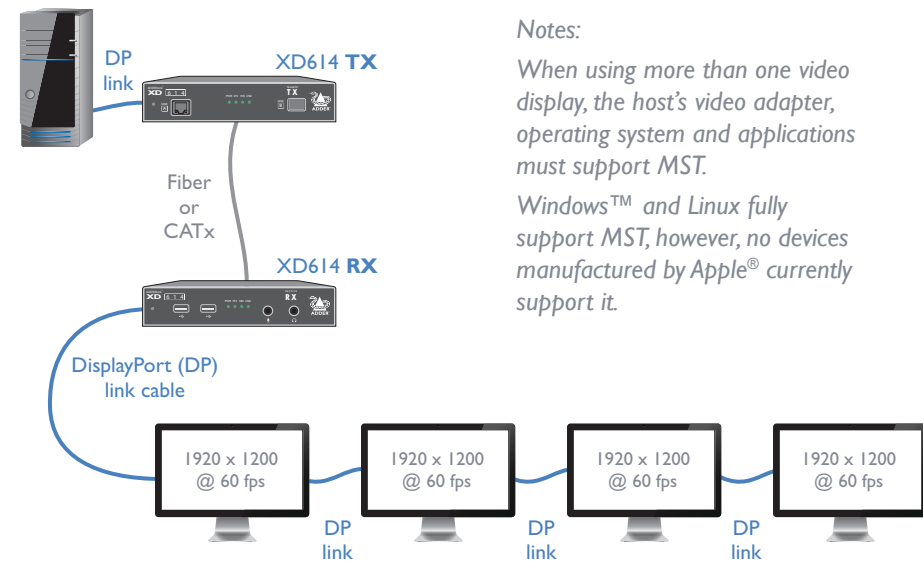

Notes:

When using more than one video display, the host's video adapter, operating system and applications must support MST.

Windows™ and Linux fully support MST, however, no devices manufactured by Apple® currently support it.

All but the final video display in the chain on the XD614 receiver must specifically support MST on DisplayPort 1.2 or later. These displays will each have a DP output port to allow the daisy-chain link to continue to the next. The last video display in the chain does not need to support MST as it is the final destination for the video signals.

Note: Check that the video card and display specifications support the required number of daisy-chained displays.

Support for multiple non-MST video displays on XD614

If you are using multiple video displays with the XD614 receiver that do not support MST, there are a couple of options:

- You can optionally enable an internal hub within the XD614 receiver which will allow non-MST video displays to be connected to the two output ports so that they can use the first and second video streams respectively. See page 19.
- You can optionally use an external MST hub, which will receive the combined DisplayPort signal from the first video port on the receiver and split out separate links to the standard video displays (see next page).

Support for multiple non-MST video displays on XD614 (cont.)

An external MST hub can receive the combined DisplayPort MST signal from the first video port on the receiver and split out separate links to standard video displays (the second video output port on the receiver will be disabled):

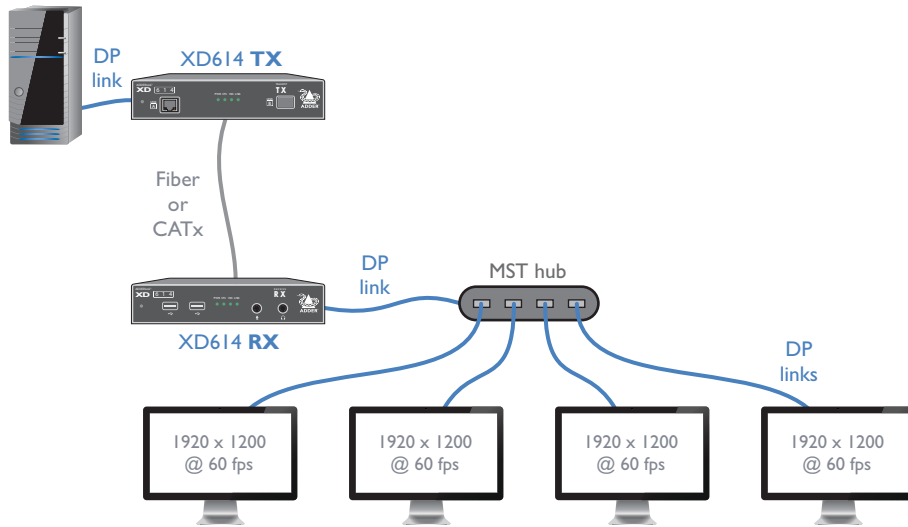

Adder does not supply MST hubs, but can recommend the following models:

- Startech™ MST Hub 1x4 (MSTDP124DP)
- Gofanco™ Prophecy MST hub 1x4 (PRO-MSTDP4DP)

Multiple displays at the local console

ADDERLink XD612: You can optionally connect up to two video displays to the second video port of the transmitter to view the output locally:

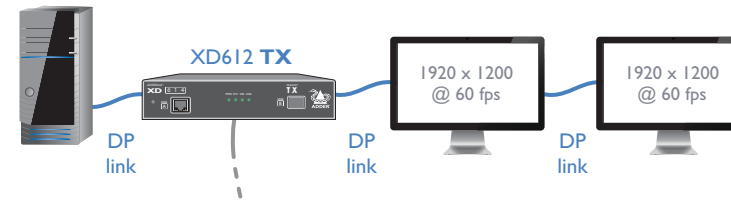

You have several connection options:

- For a two display arrangement, connect an MST-compliant video display with another display (MST-compliant or not) in a daisy-chain arrangement.
- If using two non MST-compliant video displays, connect one to the TX video output port and the other directly to the host computer's video adapter, similar to the upper part of the example shown below.
- If only a single local display is required, a non-MST display can be connected directly to the video output port.

ADDERLink XD614 supports just one console video display at the transmitter. If other local console video displays are required, then streams 2 to 4 can be accessed directly from the host computer's video adapter.

On both types of transmitters, there are no console USB outlets, so if a local keyboard and/or mouse are required, they need to be connected directly to the host computer.

Note: The display connected to the local console should support at least equal video resolution of that connected at the RX, otherwise no video will be displayed.

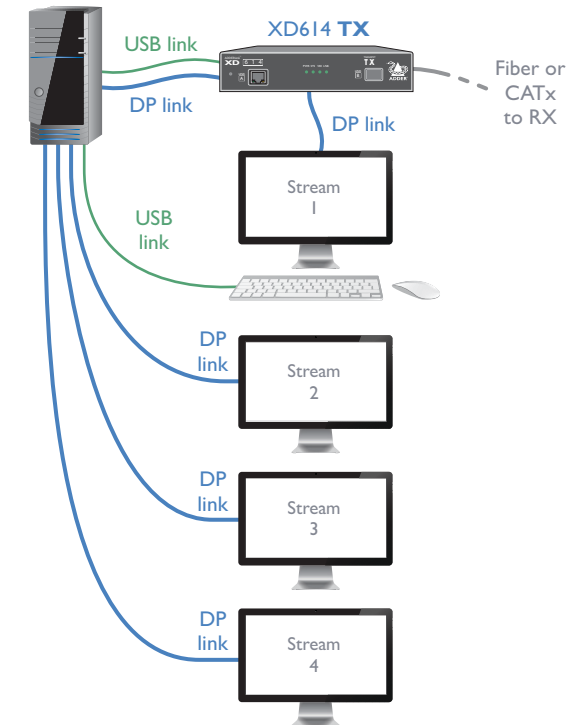

ADDERLINK XD612 FEATURES

The transmitter and receiver modules are contained within slimline metal casings that measure just 186 x 152 x 40mm.

Transmitter module

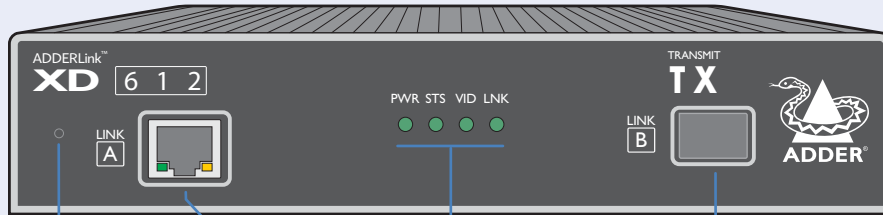

Recessed reset button
See [Resetting a module](#).

CATx port
Provides an alternative link method to fiber. See [CATx link](#).

Status indicators
These provide visual confirmation of various system functions. See [Indicators](#) for further details.

SFP+ slot
Accommodates a fiber optic SFP+ module of your choice. See [Fiber optic link](#) for further details.

Audio ports

Connects to the audio output/input ports of your computer. See [Transmitter audio links](#) for further details.

USB ports

Connect to USB ports on your computer. The outer-most port also supports USB audio streaming. See [Transmitter USB links](#) for further details.

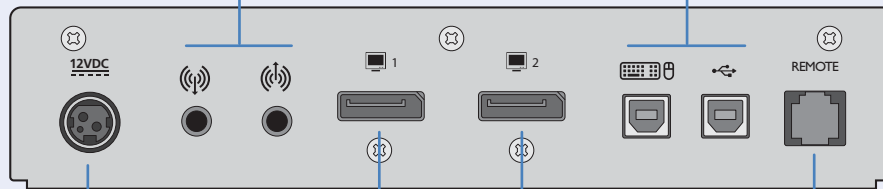

Power input
See [Transmitter power connection](#) for further details.

Video input port
Connect to the DisplayPort connector of your computer. See [Transmitter video link](#) for further details.

Video output port
Optionally connect local console video displays. See [Multi-display support using MST](#) and [Transmitter video link](#).

Remote port
Can be used for RS232 serial devices. See [Transmitter remote port](#) for further details.

Receiver module

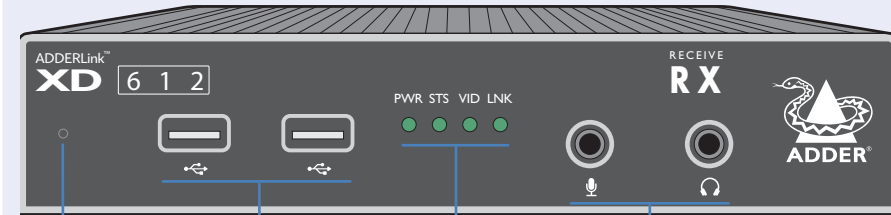

Recessed reset button
See [Resetting a module](#).

USB ports
Connect your USB keyboard, mouse and other HID peripherals. See [Receiver USB devices](#) for further details.

Status indicators
These provide visual confirmation of various system functions. See [Indicators](#) for further details.

Audio ports
Connect your microphone and headphones. See [Receiver audio devices](#) for further details.

SFP+ slot

Accommodates a fiber optic SFP+ module of your choice. See [Fiber optic link](#) for further details.

Video output ports

Port 1 provides the first video stream, port 2 provides the second, if present. See [Multi-display support using MST](#) and [Receiver video display\(s\)](#).

USB ports

Connect your USB keyboard, mouse and other HID peripherals. See [Receiver USB devices](#) for further details.

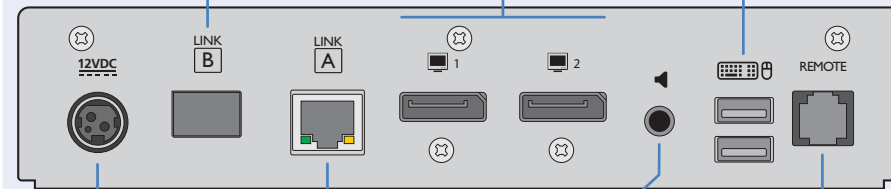

Power input
See [Receiver power connection](#) for further details.

CATx port
Provides an alternative link method to fiber. See [CATx link](#).

Speaker port
Connect your speakers. See [Receiver audio devices](#) for further details.

Remote port
Can be used for RS232 serial devices. See [Receiver remote port](#) for further details.

ADDERLINK XD614 FEATURES

The transmitter and receiver modules are contained within slimline metal casings that measure just 186 x 152 x 40mm.

Transmitter module

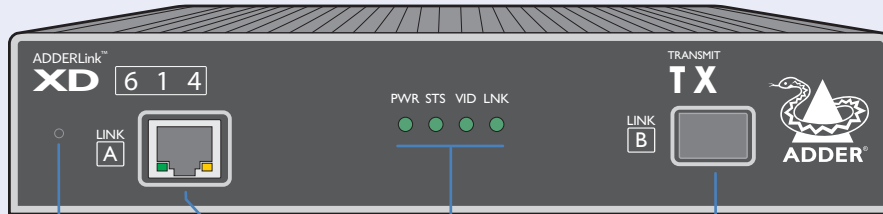

Recessed reset button

See [Resetting a module](#).

CATx port

Provides an alternative link method to fiber. See [CATx link](#).

Status indicators

These provide visual confirmation of various system functions. See [Indicators](#) for further details.

SFP+ slot

Accommodates a fiber optic SFP+ module of your choice. See [Fiber optic link](#) for further details.

Audio ports

Connects to the audio output/input ports of your computer. See [Transmitter audio links](#) for further details.

USB ports

Connect to USB ports on your computer. The outer-most port supports transparent USB. See [Transmitter USB links](#) for further details.

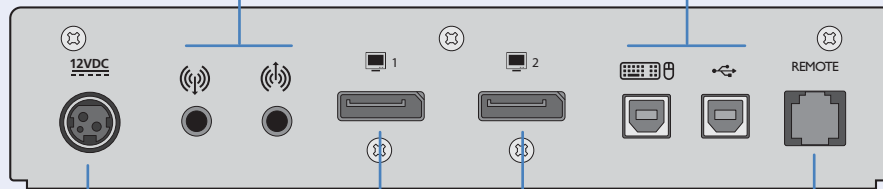

Power input

See [Transmitter power connection](#) for further details.

Video input port

Connect to the DisplayPort connector of your computer. See [Transmitter video link](#) for further details.

Video output port

Optionally connect a local console video display. See [Multi-display support using MST](#) and [Transmitter video link](#).

Remote port

Can be used for RS232 serial devices. See [Transmitter remote port](#) for further details.

Receiver module

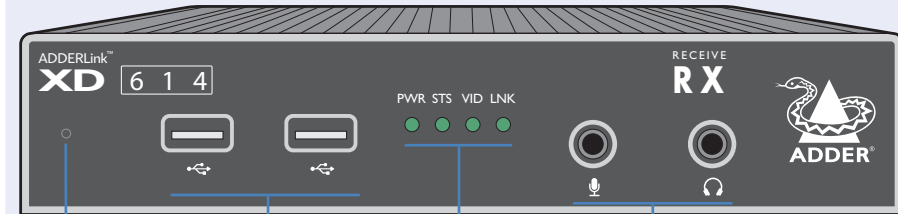

Recessed reset button

See [Resetting a module](#).

USB ports

The left port supports keyboard, mouse and other USB HID peripherals. The right port supports a wider range of devices. See [Receiver USB devices](#) for further details.

Status indicators

These provide visual confirmation of various system functions. See [Indicators](#) for further details.

Audio ports

Connect your microphone and headphones. See [Receiver audio devices](#) for further details.

SFP+ slot

Accommodates a fiber optic SFP+ module of your choice. See [Fiber optic link](#) for further details.

Video output ports

Depending on settings, either port 1 provides all four MST video streams, or port 1 and 2 provide the first two streams. See [Multi-display support using MST](#) and [Choosing RX video mode](#).

USB ports

Connect your USB keyboard, mouse and other HID peripherals. See [Receiver USB devices](#) for further details.

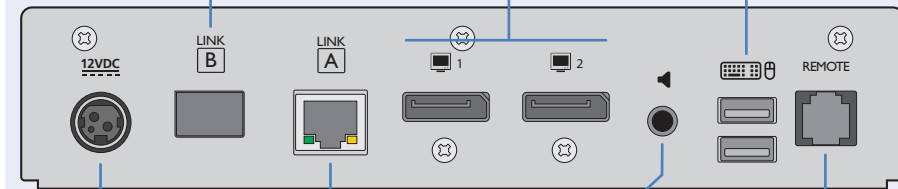

Power input

See [Receiver power connection](#) for further details.

CATx port

Provides an alternative link method to fiber. See [CATx link](#).

Speaker port

Connect your speakers. See [Receiver audio devices](#) for further details.

Remote port

Can be used for RS232 serial devices. See [Receiver remote port](#) for further details.

TECHNICAL SPECIFICATIONS

ADDERLink XD612 / 614

- Nominal Operating Power (W) 10W
- Peak Power (W) 12W
- External Power 12V DC, 1.5A
- Max operating Altitude (m) 2000m
- Operating Temp range (°C) 0 to +40°C
- Operating Humidity range (%RH) 0-80%
- Storage Temp range (°C) -10 to +50°C
- Storage Humidity range (%RH) 0-80%
- Max Thermal Dissipation (BTU) 41.94
- MTBF (Tx / Rx) 530k / 520k hours
- MTBF (Pair) 260k hours

Local unit – Transmitter (Tx)

- 4 x tri-color status indicators
- DisplayPort in and local pass-through out
- 2 x USB2.0 type B
- Line in and out analog audio
- RJ12 serial port
- RJ45 and SFP+ ports

Remote unit – Receiver (Rx)

- 4 x tri-color status indicators
- 2 x DisplayPort out
- 4 x USB2.0 type A
- Mic in, headset and speaker out
- RJ12 serial port
- RJ45 and SFP+ ports

Physical design

- Robust metal construction
- TX and RX: 186mm/7.32” (w), 39mm/1.54” (h), 148mm/5.83” (d)
- TX: 1.29kg / 2.84lbs
- RX: 1.24kg / 2.73lbs

Power supply

- 100-240VAC, 47-63Hz
- 12VDC 18W output from power supply unit.

SUPPLIED ITEMS



XD6 Ix transmitter kit

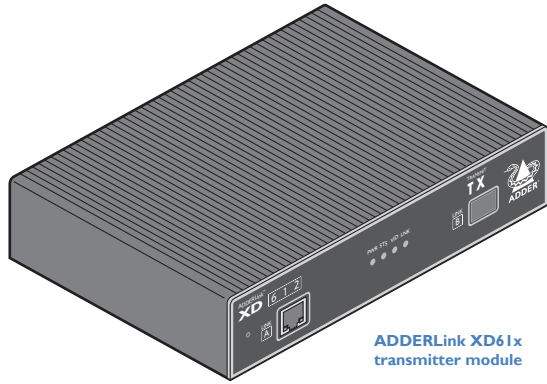

ADDERLink XD6 Ix transmitter module

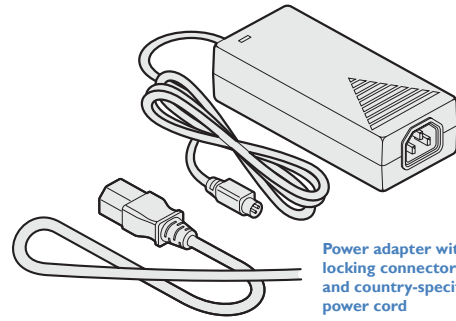

Power adapter with locking connector and country-specific power cord

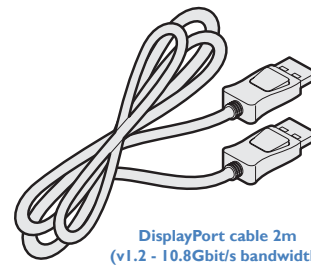

DisplayPort cable 2m (v1.2 - 10.8Gbit/s bandwidth)

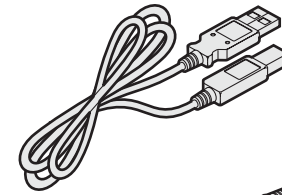

USB cable 2m (type A to B)

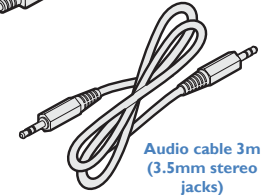

Audio cable 3m (3.5mm stereo jacks)

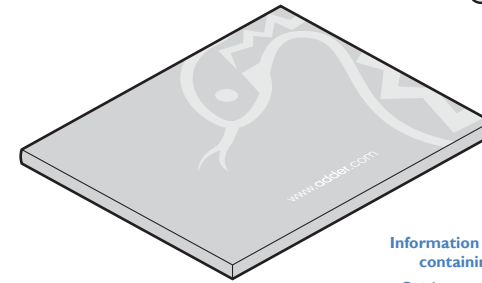

Information wallet containing:
Quick setup guide
Eight self-adhesive rubber feet
Safety document

XD6 Ix receiver kit

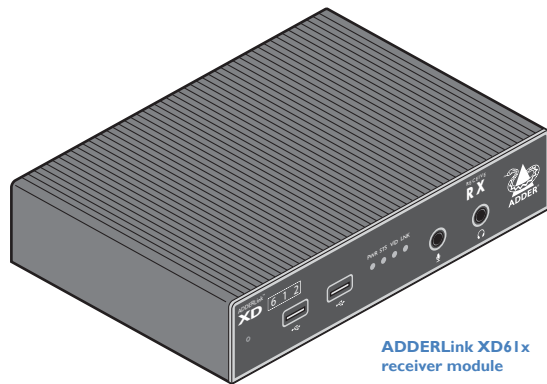

ADDERLink XD6 Ix receiver module

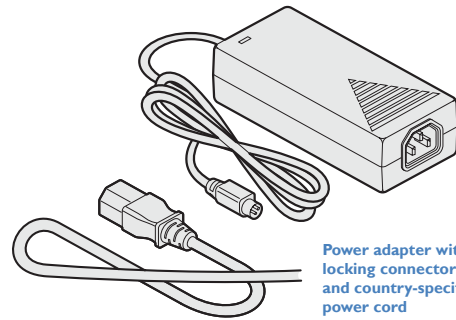

Power adapter with locking connector and country-specific power cord

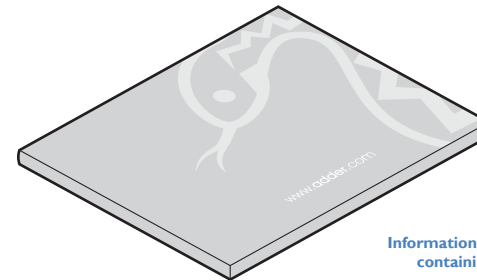

Information wallet containing:
Quick setup guide
Eight self-adhesive rubber feet
Safety document

INSTALLATION

CONFIGURATION

OPERATION

FURTHER INFORMATION

INDEX

OPTIONAL EXTRAS

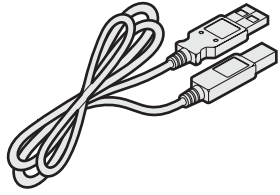

USB cable 2m (type A to B)
Part number:VSC24

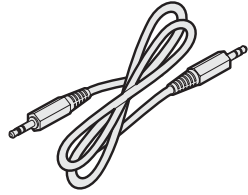

Audio cable 2m (3.5mm stereo jacks)
Part number:VSC22

Replacement power adapter with locking connector
Part number: PSU-IEC-12VDC-1.5A

Country-specific power cords
CAB-IEC-AUS (Australia)
CAB-IEC-EURO (Central Europe)
CAB-IEC-UK (United Kingdom)
CAB-IEC-USA (United States)
CAB-IEC-JAPAN (Japan)

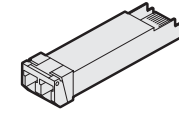
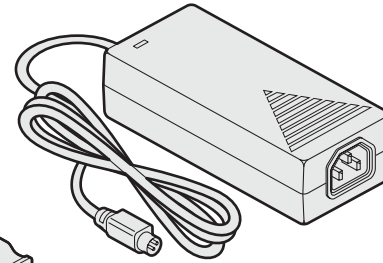

SFP+ module with LC connectors
Multi mode: SFP+-MM-LC-10G
Single mode: SFP+-SM-LC-10G

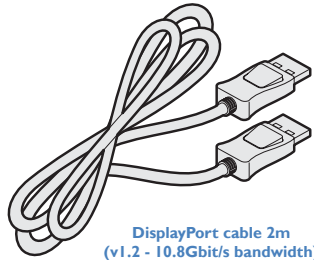

DisplayPort cable 2m (v1.2 - 10.8Gbit/s bandwidth)
Part number:VSCD17

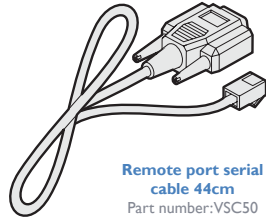

Remote port serial cable 44cm
Part number:VSC50

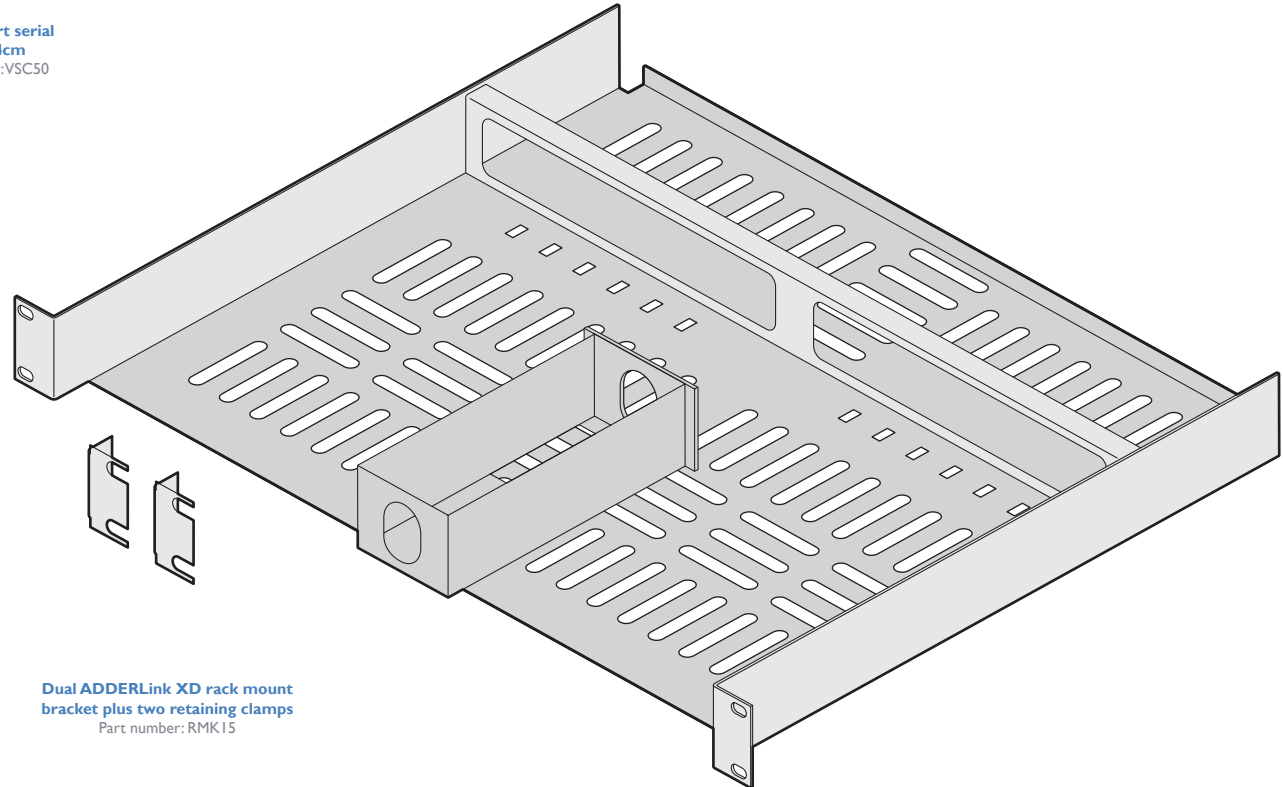
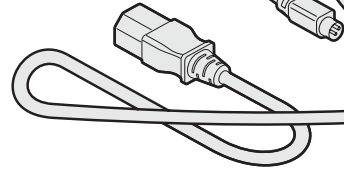

Dual ADDERLink XD rack mount bracket plus two retaining clamps
Part number:RMK15

INSTALLATION

CONFIGURATION

OPERATION

FURTHER INFORMATION

INDEX

LOCATIONS

Please consider the following important points when planning the position of the AdderLink XD modules:

- Situate the transmitter module close to the system to which it will be connected and near to a source of mains power. Place the receiver module in similar close proximity to the peripherals that it will connect with, plus a source of mains power.
- Consult the precautions listed within the supplied safety leaflet.
- Connections do not need to be carried out in the order given within this guide, however, where possible connect the *power in* as the final step.

Suitable for installation in Information Technology Rooms in accordance with Article 645 of the National Electrical Code and NFPA 75.

Peut être installé dans des salles de matériel de traitement de l'information conformément à l'article 645 du National Electrical Code et à la NFPA 75.

CONNECTIONS

Installation involves linking the transmitter module to various ports on the host computer, while the receiver module is attached to your video display(s) and peripherals:

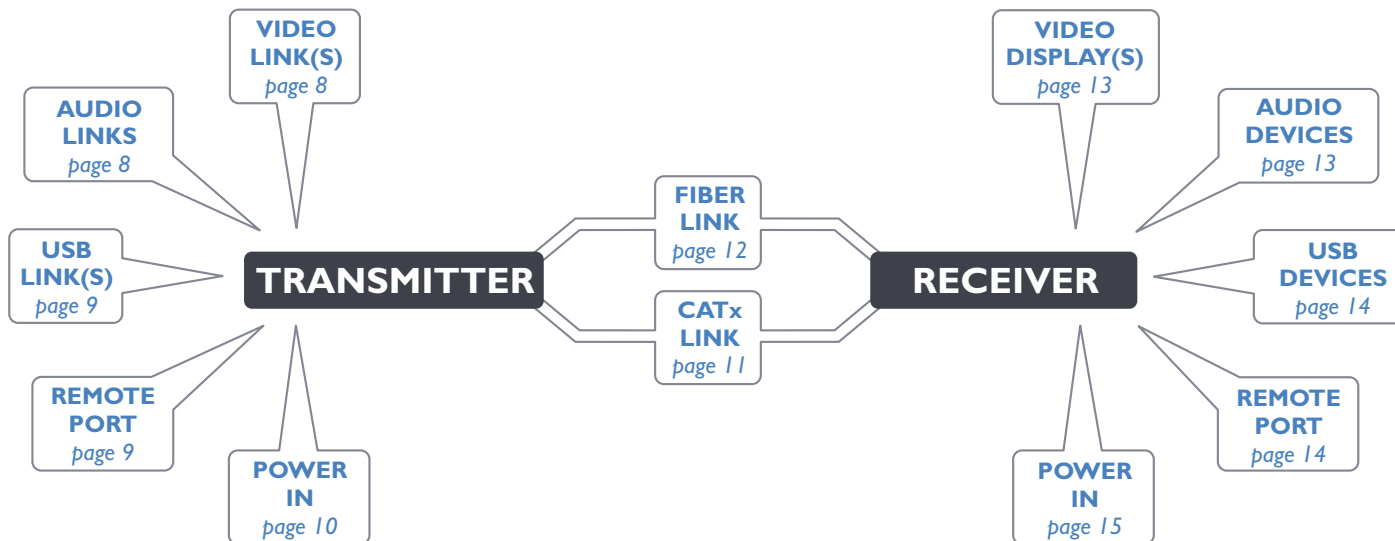

Click a connection to see details

Transmitter video link(s)

AdderLink XD modules can transfer various high resolution video modes via their DisplayPort connectors. The XD612 models support single or dual video displays while XD614 models support up to four video displays.

Note: XD612 models support up to WUXGA resolution across either CATx or fiber links. XD614 models support various resolutions, see the box below.

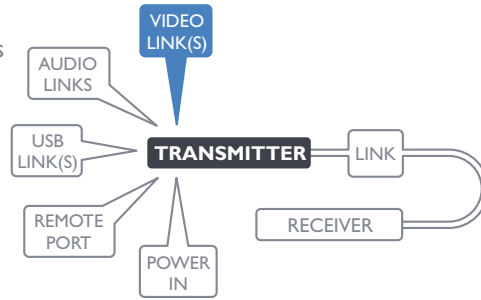

To connect the video port(s)

- 1 Connect the supplied DisplayPort link cable between the video socket 1 on the transmitter module rear panel and the video output socket of the host computer.
- 2 Optionally connect local video display(s) to video socket 2 on the transmitter module rear panel. See page 3.

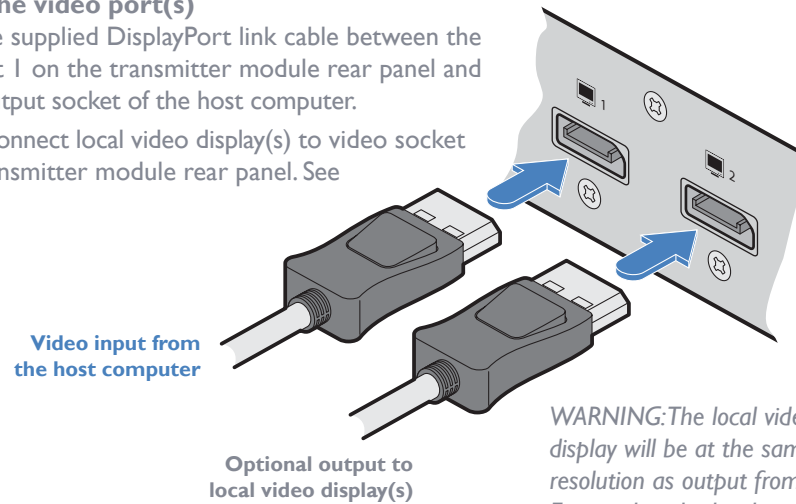

WARNING: The local video display will be at the same resolution as output from the RX. Ensure that the local monitor can handle the required resolution.

Maximum video resolutions

The extenders support the following maximum video resolutions:

	Fiber (up to 4km) or CATx (up to 100m)
XD612	1 display at 1920 x 1200 / 60fps (WUXGA) 2 displays at 1920 x 1200 / 60fps (WUXGA)
XD614	1 display at 4096 x 2160 / 60fps (4K) 2 displays at 2560 x 1600 / 60fps (WQXGA) 3 displays at 1920 x 1200 / 60fps (WUXGA) 4 displays at 1920 x 1200 / 60fps (WUXGA)

Transmitter audio links

The AdderLink XD modules support analog stereo audio in and out connections. Where necessary, make connections between the audio input and/or output ports of the host computer and the transmitter module.

Note: Digital 2-channel (stereo) audio is also supported separately via the DisplayPort connectors as a transparent link-through.

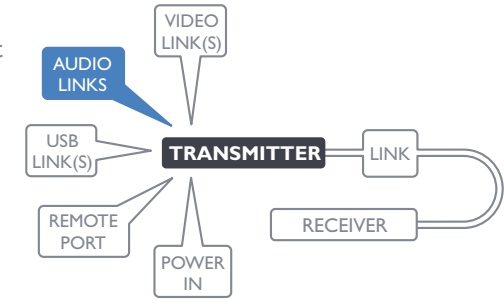

To connect the audio ports

- 1 For the line in and/or line out ports, connect the supplied audio link cable between the audio port on the transmitter module rear panel and the line in or line out socket of the host computer.

From the audio output on the host computer

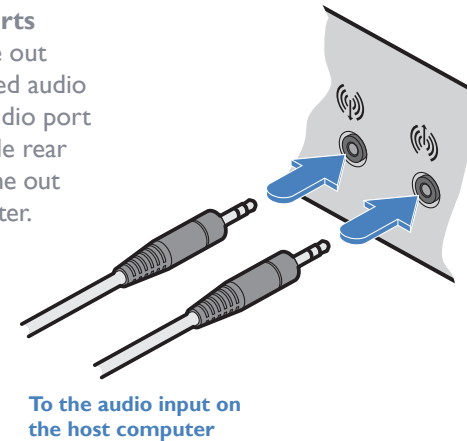

To the audio input on the host computer

Transmitter USB links

The transmitter module has two USB input ports on its rear panel:

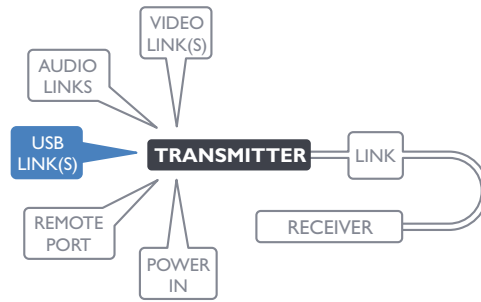
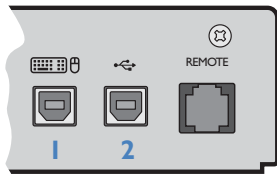

The ports have different functions:

1	2
USB HID (Human Interface Device) feed to all USB ports on the receiver	USB audio feed to/from the analog audio ports labeled on the receiver

To connect the USB port(s)

- 1 Connect the type B connector of the supplied USB/video cable to the left-hand side USB port (labeled '1' on the diagram above) on the rear panel of the transmitter module.

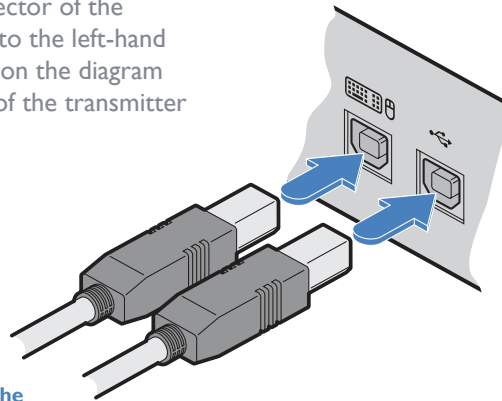

USB links from the host computer

- 2 Connect the type A connector of the cable to a vacant USB port on the host computer.
- 3 Repeat steps 1 and 2 for the second port if USB audio/transparent USB are required (see table above).

Transmitter Remote port

The Remote port has a dual role, it can either:

- Allow an optional remote control to be connected to the module, or
- Create an RS232 serial connection with the receiver module.

When serial devices are attached to the Remote ports on the transmitter and receiver modules, the units transparently convey the signals between them at rates up to 115200 baud - no serial configuration is required. An optional serial cable (part number: VSC50) is available from Adder.

To connect the Remote port

- 1 Use the optional serial cable (VSC50) to link the Remote port on the rear panel of the transmitter module with a vacant RS232 serial port on your host computer.

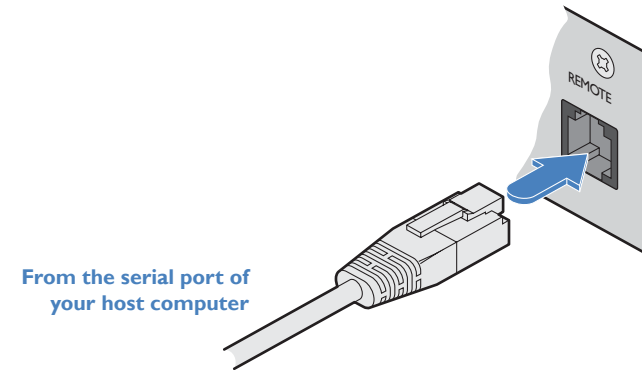
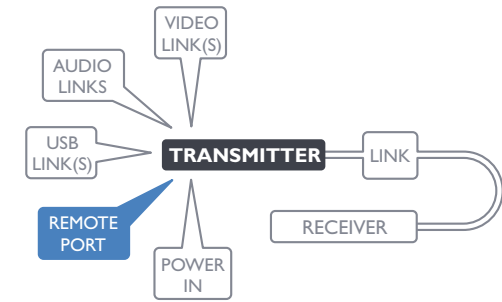

From the serial port of your host computer

Please see [Appendix 1](#) for pin-out details of the Remote port.

Transmitter power connection

There is no on/off switch on either of the AdderLink XD modules, so operation begins as soon as power is applied. The power adapters supplied with the modules use locking-type plugs to help prevent accidental disconnections; please follow the instructions shown on the right whenever disconnecting a power adapter.

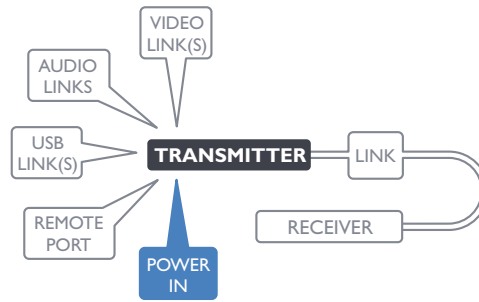

To connect the power adapter

- 1 Attach the output plug of the supplied power adapter to the power input socket on the right side of the rear panel.

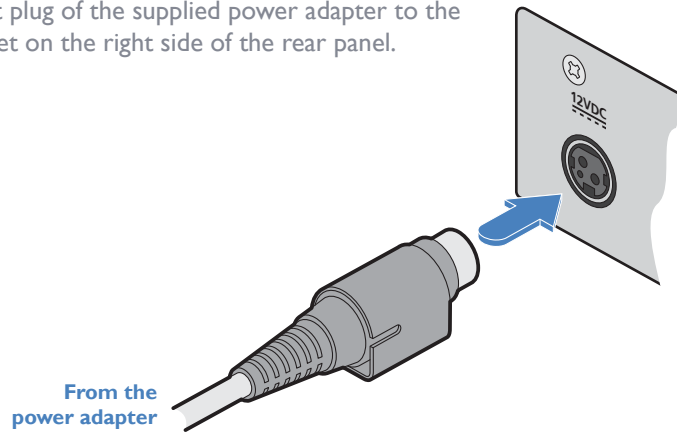

- 2 Connect the IEC connector of the supplied country-specific power cord to the socket of the power adapter.

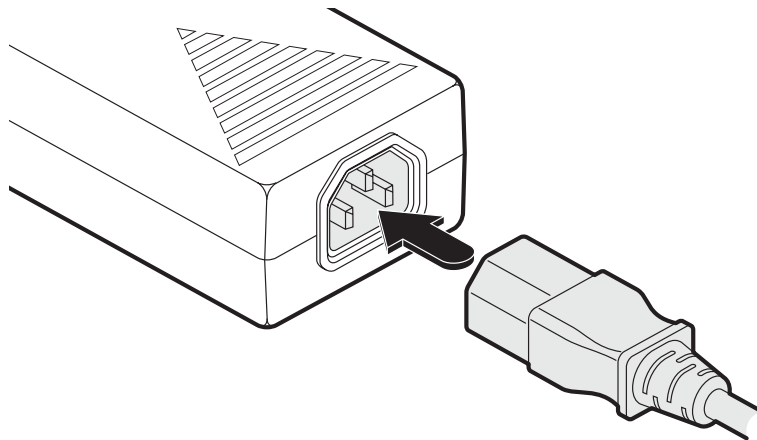

- 3 Connect the power cord to a nearby mains supply socket.

To disconnect the power adapter

- 1 Isolate the power adapter from the mains supply.
- 2 Grasp the outer body of the power adapter plug where it connects with the module.
- 3 Gently pull the body of the outer plug away from the module. As the body of the plug slides back, it will release from the socket and you can fully withdraw the whole plug.

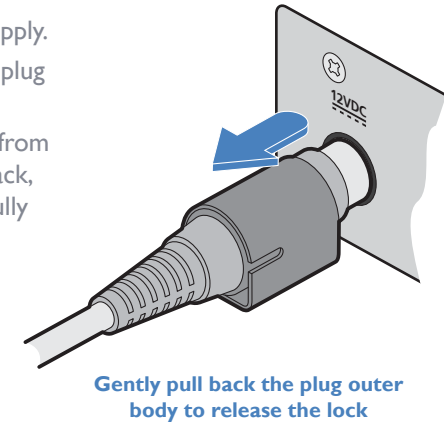

IMPORTANT: Please read and adhere to the electrical safety information given within the supplied safety leaflet. In particular, do not use an unearthed power socket or extension cable.

Note: Both the modules and the power supplies generate heat when in operation and will become warm to the touch. Do not enclose them or place them in locations where air cannot circulate to cool the equipment. Do not operate the equipment in ambient temperatures exceeding 40 degrees Centigrade. Do not place the products in contact with equipment whose surface temperature exceeds 40 degrees Centigrade.

Linking

ADDERLink XD transmitters and receivers can be linked using either:

- CATx (see below), or
- Fiber (see next page)

CATx link

The CATx ports on each module (labeled Link A) allow you to create direct links of up to 50m (when using CAT5e) or 100m (when using CAT6). In order to work in CATx mode, the SFP+ fiber modules must be removed from their sockets.

Note: The CATx ports are not network ports and should not be connected to network switches or computer ports.

To make the CATx link

1 Connect a CATx (CAT 5e to 7 as required) cable between the Link A ports on the transmitter (front panel) and the receiver (rear panel):

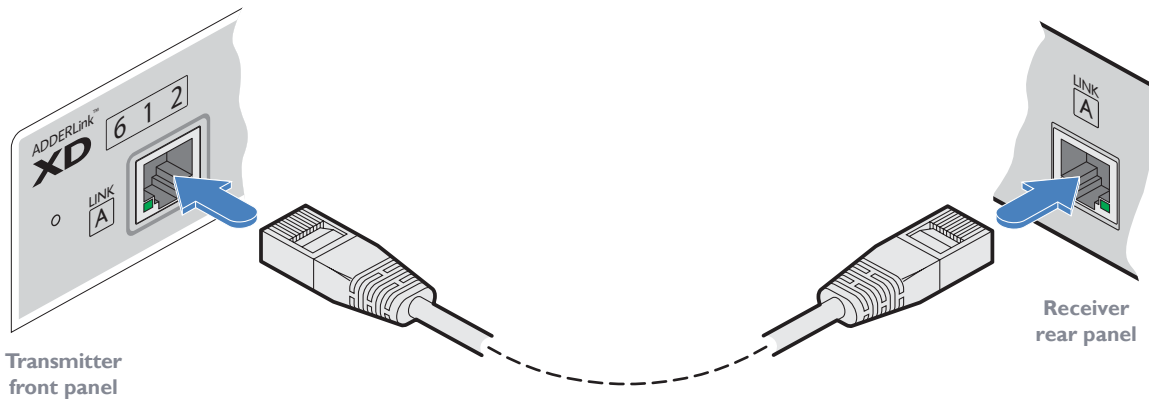

2 In operation, ensure that both indicators on the CATx connectors are green. See right.

CATx status indicators

The status indicators on the CATx port connector of each module provide further status information when a CATx link is in use:

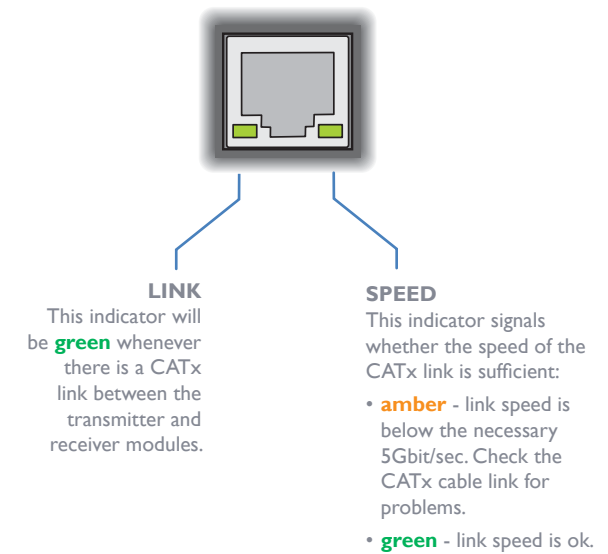

Fiber optic link

Each pair of AdderLink XD modules require optional SFP+ fiber optic modules of your choice (single or multi-mode). The fiber optic cable used must match the SFP+ type and also be of a suitable type for the distance being covered. See [Transmission distances](#) for details.

To make the fiber optic link

IMPORTANT: Ensure the power supply is off/disconnected before inserting or removing an SFP+ module.

- 1 Remove an SFP+ module from its protective packing and insert it fully into the empty slot on the AdderLink XD module. The XD transmitter slot is located on the front panel; the XD receiver slot is situated on the rear panel:

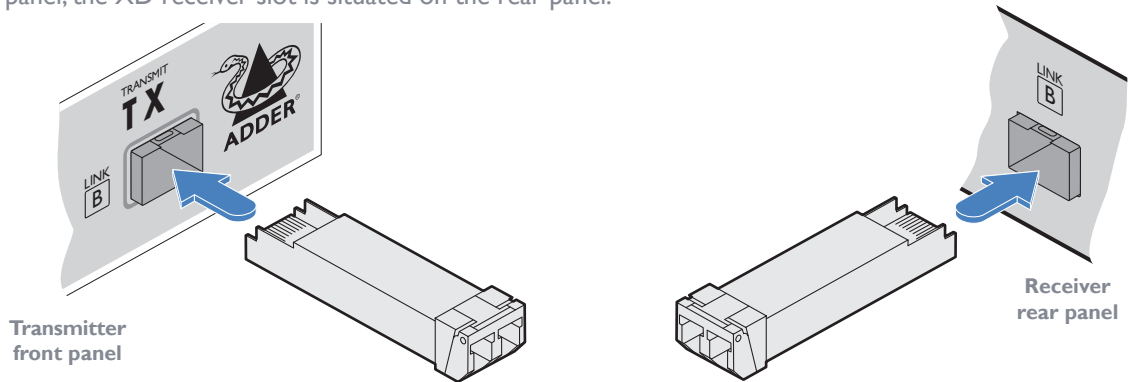

- 2 Repeat for the other SFP+ module on the other module.
- 3 For each SFP+ module, remove the black rubber insert that protects the sensors.
- 4 If fitted, remove the dual inserts that protect the fiber optic connectors.
- 5 Insert the fiber optic connectors into the SFP+ module so that they click into place:

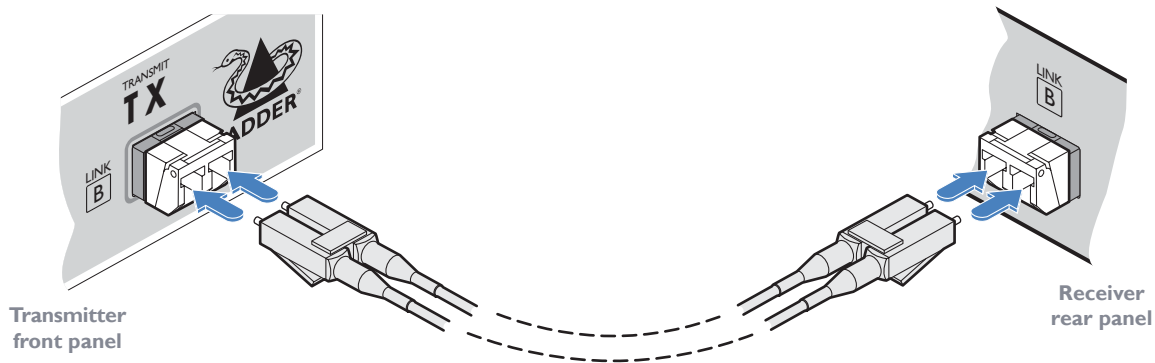

- 6 Repeat steps 4 and 5 at the other end.



Note: In order to maintain a high level of confidence in the fiber optic link, it is recommended that Adder supplied SFPs are used: (SFP+-MM-LC-10G or SFP+-SM-LC-10G).

If alternative parts are used, the system will detect this and will flash the front panel LNK indicator.

To remove an SFP+ module

- 1 If fitted, remove the dual fiber optic connectors from the SFP+ module (press in the release tab of the fiber optic connectors to disengage them).
- 2 Unclip the small extraction lever and open it out (this action releases a locking tab and also provides a grip point).

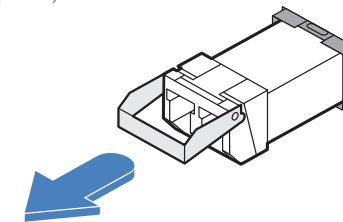

- 3 Gently pull on the extraction lever to withdraw the SFP+ module from the slot.
- 4 If the SFP+ module and/or fiber optic connector will remain unused for any period of time, be sure to fit the protective inserts to keep the optical interfaces clean.

Receiver video display(s)

Two DisplayPort sockets are provided on the rear panel of each receiver module. On XD612 models, video streams 1 and 2 are presented at the ports. On XD614 models, either all four possible MST streams are provided at port 1 OR just the first and second streams are provided at ports 1 and 2. See page 19 for details about setting changes.

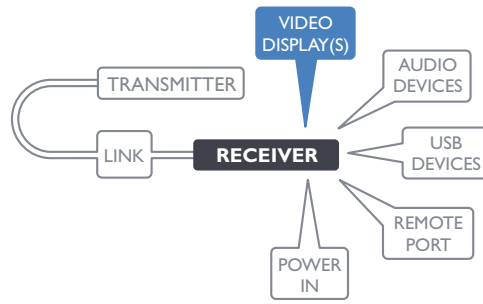

To connect the video display

- 1 Connect the signal cable from your primary video display to port 1 on the rear panel of the receiver module.
- 2 If used, repeat for the secondary video display on port 2.

To primary video display or the first of multiple MST-compliant displays

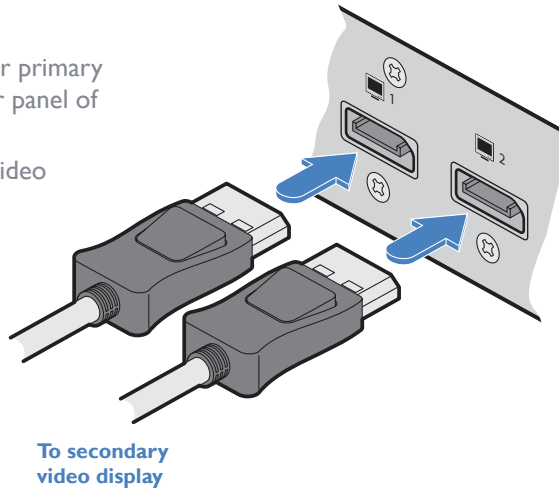

EDID management

The EDID (Extended Display Identification Data) is read from the connected video display at the receiver module; it is then transferred to, and stored within, the transmitter module and then declared to the host computer. If the video display is removed then the cloned EDID stored at the transmitter module will still be presented to the video source.

Maximum video resolutions

The extenders support the following maximum video resolutions (all at 60 fps):

	Fiber (up to 4km)	CATx (up to 100m)
XD612	1 display at 1920 x 1200 2 displays at 1920 x 1200	1 display at 1920 x 1200 2 displays at 1920 x 1200
XD614	1 display at 4096 x 2160 2 displays at 2560 x 1600 3 displays at 1920 x 1200 4 displays at 1920 x 1200	1 display at 4096 x 2160 2 displays at 2560 x 1600 3 displays at 1920 x 1200 4 displays at 1920 x 1200

Receiver audio devices

The receiver module can support multiple analog audio devices, such as stereo headphones, a mono microphone or line-level in/out connections.

USB audio is also supported when the left hand USB socket on the XD rear panel is connected to the computer. The audio signals received from the computer will be transferred to the analog audio sockets on the receiver. USB audio will take precedence over the 3.5mm audio jacks when both sources are present.

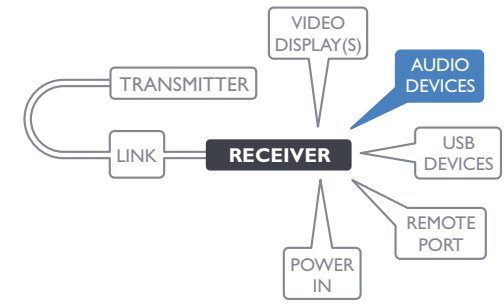

To connect audio devices

- 1 Connect stereo headphones and/or a mono microphone to the 3.5mm jack audio sockets on the front panel of the receiver module.

From mono microphone

To stereo headphones

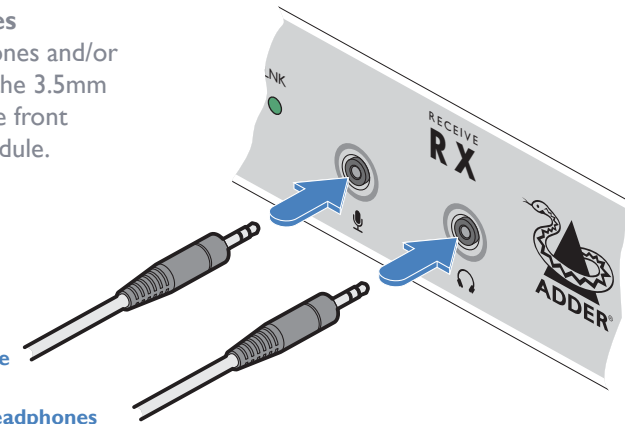

- 2 Optionally use the rear panel 3.5mm jack audio socket to connect line-level audio devices, such as powered speakers.

To speakers

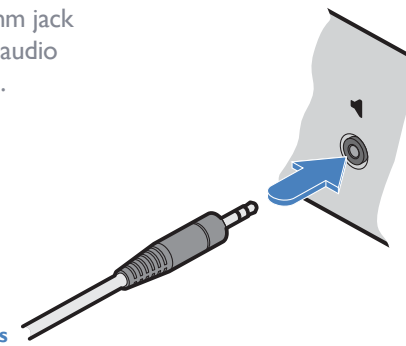

Note: Digital audio sent via the DisplayPort connectors are passed straight through from the transmitter to the receiver ports and remain completely separate from the analog audio signals.

Receiver USB devices

Each receiver module contains a USB hub that can support up to multiple v2.0 or v1.1 USB HID (Human Interface Device) peripherals.

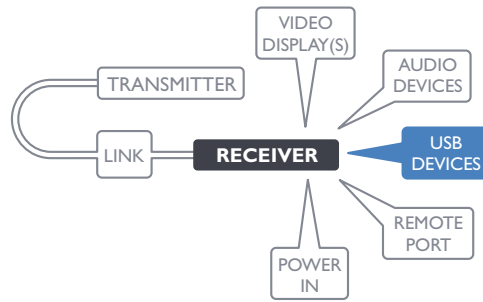

To connect USB devices

1 Connect your USB keyboard, mouse and any other two USB devices to the four sockets distributed on the front and rear panels of the receiver module.

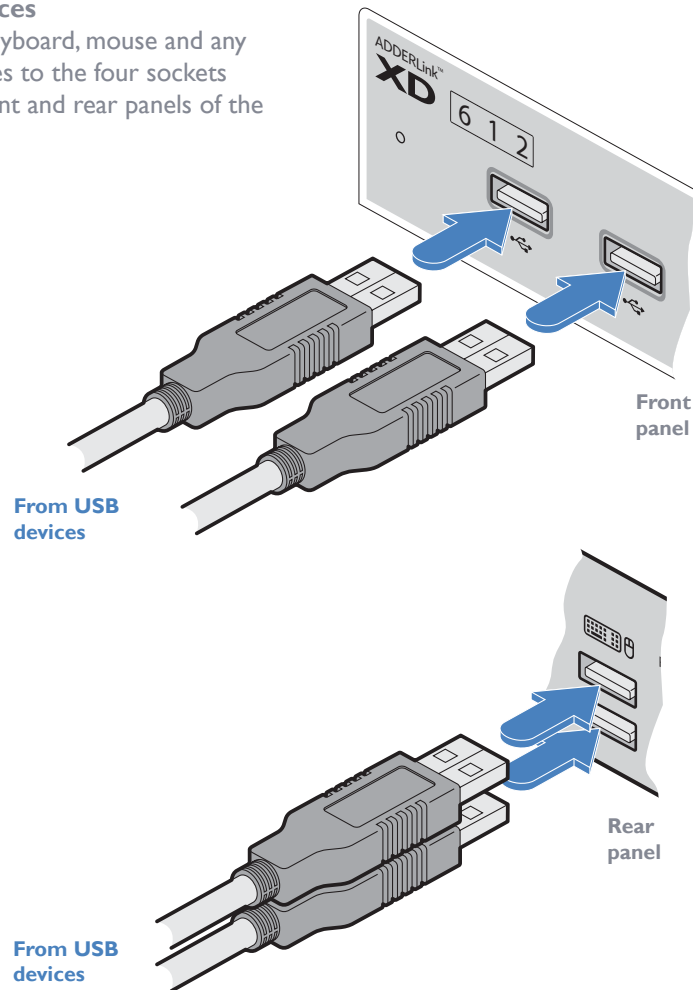

Receiver Remote port

The Remote port has a dual role, it can either:

- Allow an optional remote control to be connected to the module, or
- Create an RS232 serial connection with the receiver module.

When serial devices are attached to the Remote ports on the transmitter and receiver modules, the units transparently convey the signals between them at rates up to 115200 baud - no serial configuration is required. An optional serial cable (part number: VSC50) is available from Adder.

To connect the Remote port

1 Use the optional serial cable (VSC50) to link the Remote port on the rear panel of the transmitter module with a vacant RS232 serial port on your host computer.

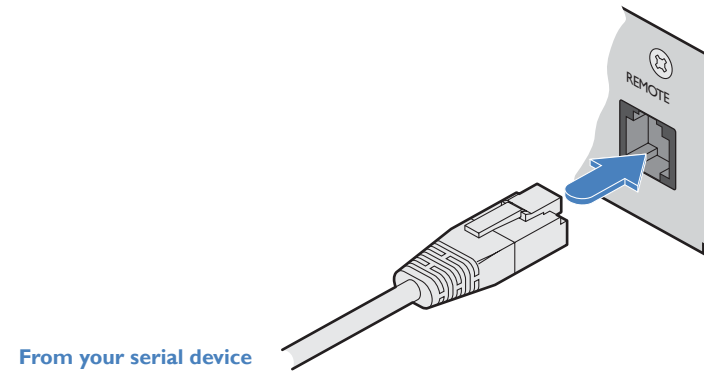
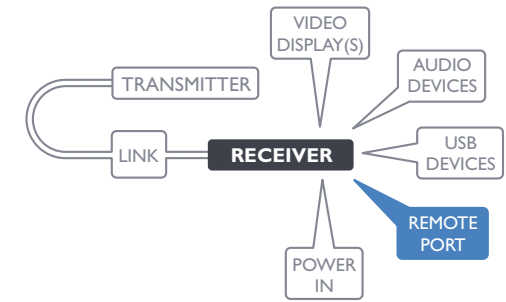

Please see [Appendix I](#) for pin-out details of the Remote port.

Receiver power connection

There is no on/off switch on either of the AdderLink XD modules, so operation begins as soon as power is applied. The power adapters supplied with the modules use locking-type plugs to help prevent accidental disconnections; please follow the instructions shown on the right whenever disconnecting a power adapter.

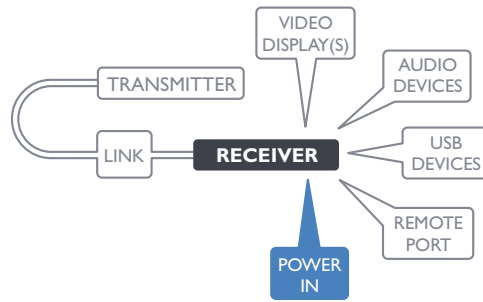

To connect the power adapter

- 1 Attach the output plug of the supplied power adapter to the power input socket on the right side of the rear panel.

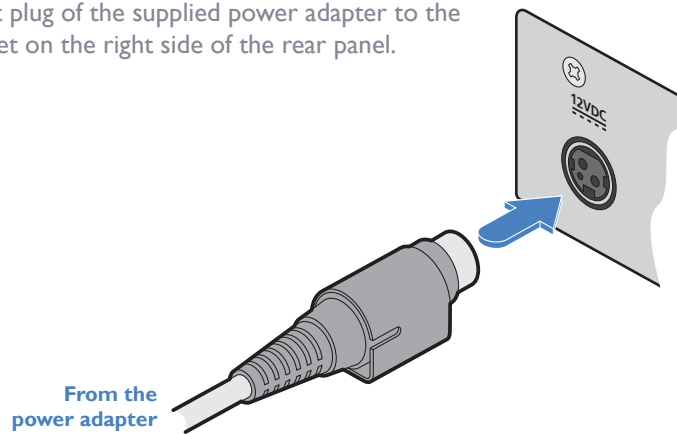

- 2 Connect the IEC connector of the supplied country-specific power cord to the socket of the power adapter.

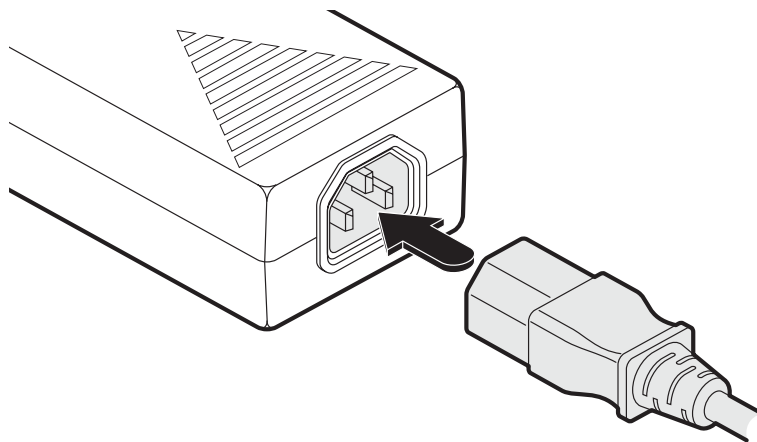

- 3 Connect the power cord to a nearby mains supply socket.

To disconnect the power adapter

- 1 Isolate the power adapter from the mains supply.
- 2 Grasp the outer body of the power adapter plug where it connects with the module.
- 3 Gently pull the body of the outer plug away from the module. As the body of the plug slides back, it will release from the socket and you can fully withdraw the whole plug.

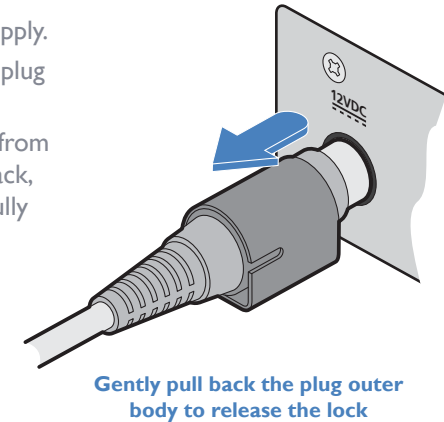

IMPORTANT: Please read and adhere to the electrical safety information given within the supplied safety leaflet. In particular, do not use an unearthed power socket or extension cable.

Note: Both the modules and the power supplies generate heat when in operation and will become warm to the touch. Do not enclose them or place them in locations where air cannot circulate to cool the equipment. Do not operate the equipment in ambient temperatures exceeding 40 degrees Centigrade. Do not place the products in contact with equipment whose surface temperature exceeds 40 degrees Centigrade.

ACCESSING THE DASHBOARD

AdderLink XD modules generally configure themselves automatically, collecting EDID information from the attached monitor(s) and passing the details to the host computer. Unless an issue is encountered, the modules will begin working together correctly as soon as they are connected. The front panel indicators provide the primary source of status information, however, there is also a Dashboard popup which provides certain other details on the primary console display.

To access the dashboard

- 1 Using your console keyboard attached to the receiver module, press (and release) the **Ctrl** key **three times** in quick succession (either of the keyboard's Ctrl keys can be used).
In response, the three keyboard indicators will all flash, once per second.
- 2 Press the numeric key **1** located above the main section of the keyboard.

The Dashboard will be displayed, similar to this:

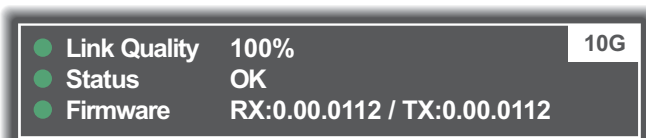

The example above shows a configuration that is working correctly. If the communication link was working correctly, but the video signal was lost, it might report as follows:

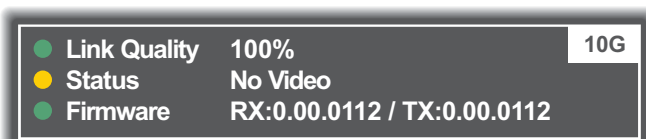

If the communication link was missing then the dashboard would report the issue similar to this:

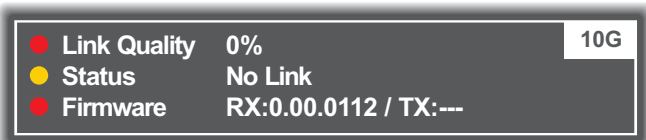

To exit the dashboard

- Press (and release) the **Ctrl** key **three times** in quick succession and then press the numeric key **1** located above the main section of the keyboard (not the numeric keypad).

CHOOSING RX VIDEO MODE (XD614 models only)

ADDERLink XD receivers contain an internal DisplayPort MST hub. On the XD614 models you can choose to either use it or bypass it. When bypassed (default setting), the full combined MST (Multi-Stream Transport) signal received from the transmitter is sent directly to video port 1. If the internal hub is engaged, then the first and second SST video streams (Single-Stream Transport) are decoded and sent to ports 1 and 2 respectively. The two modes are as follows:

- **SST mode** - This mode engages the internal hub and delivers the first and second (SST) video streams to the video ports on the receiver.
- **MST mode** - (Default) This mode bypasses the internal hub and delivers all four possible (MST) video streams directly to video port 1 on the receiver. Port 2 is disabled. Connect to either MST-compliant displays or an MST hub.

To choose the receiver video mode

- 1 Using your console keyboard attached to the receiver module, press (and release) the **Ctrl** key **three times** in quick succession (either of the keyboard's Ctrl keys can be used).
In response, the three keyboard indicators will all flash, once per second.
- 2 Press the numeric key located above the main section of the keyboard (not the numeric keypad) which represents the required mode:
 - **8** for SST mode,
 - **9** for MST mode.

The current mode will be displayed on the Dashboard next to the link speed, eg SST or MST:



Notes:

- If the mode is changed, this will cause the RX to reboot.
- If you do not press any key within five seconds, or press any key other than the digits 1, 8 or 9 (or once you have successfully chosen an action), the keyboard will revert to normal operation. To use another hotkey function, repeat the whole procedure described above.

The color of the Dashboard's **Link Quality** indicator matches the front panel **LNK** indicator:

- **Red** 0-25% quality
- **Amber** 25-50% quality
- **Yellow** 50-75% quality
- **Green** 75-100% quality

RESETTING A MODULE

On the left side of the front panel of each module, you will find a small reset hole which is used to invoke special functions.

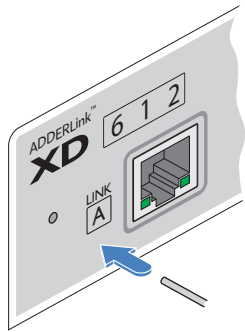

To reset a module

- 1 Use a thin implement, such as a straightened paperclip to press and release the button concealed behind the small hole. The PWR indicator will show **red**.

After a few seconds, the indicator will change from **red** to **green** to show that the reset procedure is complete.

UPGRADING FIRMWARE

Firmware upgrades are periodically made available for products via the Adder website (www.adder.com). Use this procedure to upgrade the firmware in both ADDERLink XD extenders.

Note: XD612 upgrades require roughly 6 minutes to complete; XD614 upgrades require roughly 11 minutes.

To upgrade the firmware

- 1 Download the appropriate firmware upgrade file from the *Downloads* section of the ADDERLink XD product page within the Adder website. Copy the upgrade file to an empty (but FAT32-formatted) USB memory stick.
- 2 Ensure that the transmitter and receiver are linked and powered on. Also check that there are no USB drives inserted in the receiver module's ports.
- 3 On the receiver, press and hold a thin implement, such as a straightened paperclip, in the reset hole until the receiver's STS indicator flashes red/blue. The receiver is now in upgrade mode.
- 4 Wait for the STS indicator link to turn green, signifying that the link is established.
- 5 Insert the memory stick containing the upgrade file into the front panel left USB port.

The upgrade should begin and both units will flash their STS indicators red/green to show the upgrade process is in progress. Following a successful upgrade, both units will automatically reboot and run the new firmware.

- If for any reason the upgrade fails, the STS indicator will change to red to indicate an error. Refer to the Dashboard for details (see page 19). If necessary, reboot the module to make it use the existing firmware version.

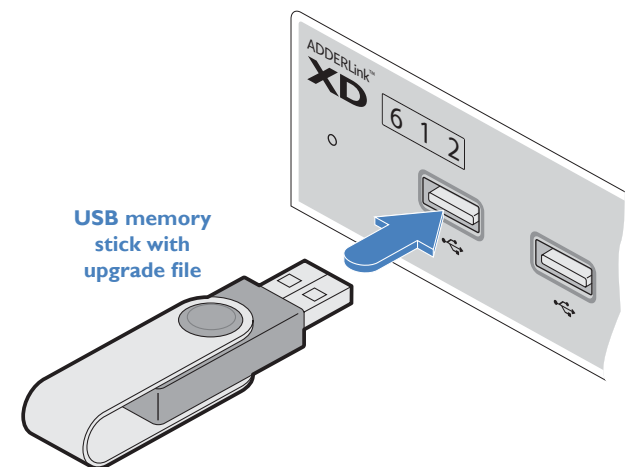
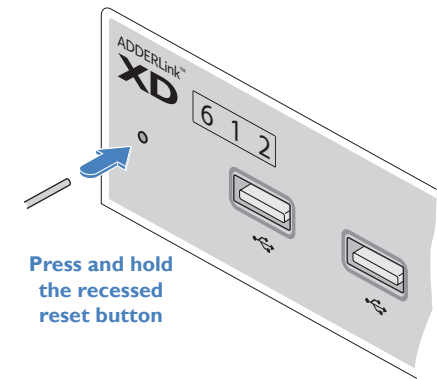

The AdderLink XD modules are designed to be transparent in operation; all peripherals should respond exactly as they would when situated next to your host computer.

INDICATORS

The transmitter and receiver modules contain various indicators to provide you with status information. Both modules have four red indicators on their front panels.

Status indicators

The multi-color status indicators on the front panels of each module mostly behave in the same manner at the same time:

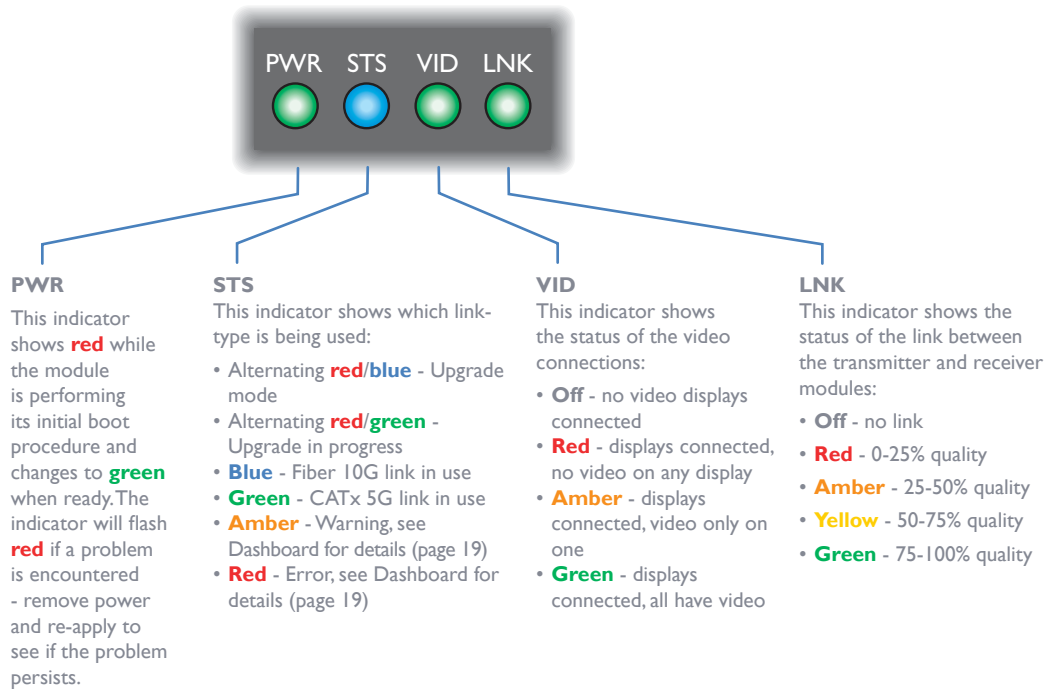

CATx status indicators

The status indicators on the CATx port connector of each module provide further status information when a CATx link is in use:

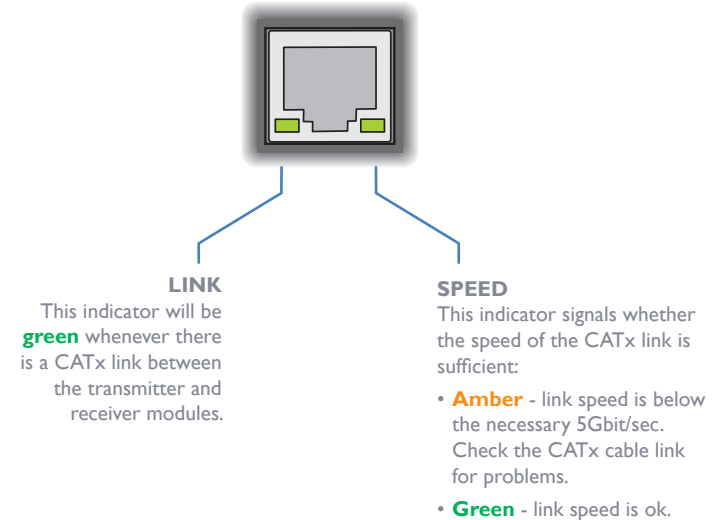

Further information



This chapter contains a variety of information, including the following:

- Getting assistance - see right
- [Appendix I](#) - Remote (Options) port pin-out

GETTING ASSISTANCE

If you are still experiencing problems after checking the information contained within this guide, then please refer to the Support section of our website:

www.adder.com

INSTALLATION

CONFIGURATION

OPERATION

FURTHER
INFORMATION

INDEX

APPENDIX I - REMOTE PORT PIN-OUT

The **REMOTE** port uses a 6p6c socket. The pin-out is listed below.

Note: Although the pins labeled 'Not used' is inactive, it is still connected internally and so no links should be made at all to this pin.

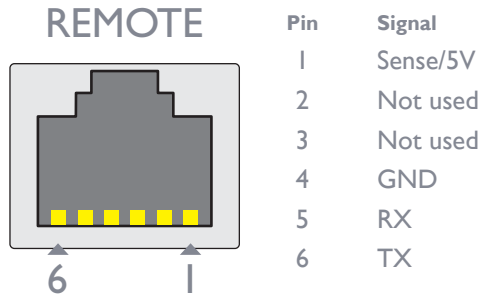

Note: The TX detects presence of an incoming power signal to determine whether 5V should be supplied at the RX.

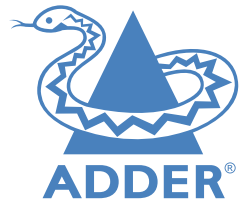

www.adder.com

Documentation by:



www.ctxd.com

© 2021 Adder Technology Limited
All trademarks are acknowledged.
Part No. MAN-000014 • Release 1.1

- A**
 - Audio devices
 - Receiver 16
 - Audio links
 - transmitter 11
- C**
 - CATx
 - link 14
 - status indicators 14
 - Connections
 - overview 10
- D**
 - Dashboard 19
- F**
 - Fiber
 - distances 2
 - Fiber optic
 - link 15
 - Firmware
 - upgrade 20
- H**
 - HID 12
- L**
 - Linking
 - overview 14
- M**
 - MST 3,19
 - Multi-Stream Transport 19
- O**
 - Optional extras 9
 - OSD
 - Dashboard 19
- P**
 - Power connection
 - Receiver 18
 - transmitter 13
- R**
 - Remote port
 - pin-out 23
 - Receiver 17
 - transmitter 12
 - Reset 20
- S**
 - SFP+ modules 2,15
 - Single-Stream Transport 19
 - SST 19
 - Status indicators 21
 - Supplied items 8
- U**
 - Upgrade
 - firmware 20
 - USB devices
 - Receiver 17
 - USB links
 - transmitter 12
- V**
 - Video display(s)
 - Receiver 16
 - Video hub 3
 - Video links
 - transmitter 11