



**THE DISPLAY CHOICE
OF PROFESSIONALS™**

IFP-6502, IFP-7502 & IFP-8602 4K UHD Interactive Display

displays.agneovo.com

User Manual

TABLE OF CONTENTS

SAFETY INFORMATION	1
Federal Communications Commission (FCC) Notice (U.S. Only).....	1
Polish Center for Testing and Certification Notice	1
Electric, Magnetic and Electromagnetic Fields (“EMF”)	2
Information for U.K. only.....	3
North Europe (Nordic Countries) Information.....	4
End-of-Life Disposal	5
Waste Electrical and Electronic Equipment-WEEE.....	5
Turkey RoHS.....	6
Ukraine RoHS	6
PRECAUTIONS	7
Cautions When Setting Up	7
Cautions When Using.....	8
Cleaning and Maintenance.....	8
Notice for the Interactive Display.....	9
Caring for the Touch Screen.....	9
CHAPTER 1: PRODUCT DESCRIPTION.....	10
1.1 Unpacking	10
1.2 Package Contents	10
1.3 Preparing for the Installation	11
1.4 Wall Mounting Installation.....	11
1.4.1 VESA Grid	12
1.4.2 Mounting the Interactive Display on the Wall.....	12
1.4.3 Ventilation Requirements for Enclosure Locating	14
1.5 Installing the Wi-Fi Module	14
1.6 Interactive Display Overview	16
1.6.1 Control Panel.....	16
1.6.2 Input/Output Terminals	17
1.7 Remote Control	19
1.7.1 General Functions	19
1.7.2 Inserting the Batteries in the Remote Control	21
1.7.3 Handling the Remote Control	21
1.7.4 Operating Range of the Remote Control.....	22
CHAPTER 2: MAKING CONNECTIONS.....	23
2.1 Connecting the Power	23
2.2 Connecting a Computer or Portable Device.....	24
2.2.1 Using VGA (D-Sub) Input	24
2.2.2 Using RS232 Input	25
2.2.3 Using HDMI Input.....	25
2.2.4 Using the Touch Module.....	26
2.3 Connecting External Equipment (Video Player)	28
2.4 Connecting a Display Device	29
2.5 Connecting to a Wired Network.....	30
2.6 Connecting USB Interface Devices	31

TABLE OF CONTENTS

2.7 Connecting Audio Equipment	32
CHAPTER 3: USING THE INTERACTIVE DISPLAY	33
3.1 Turning on the Power	33
3.2 Selecting the Input Source Signal	33
3.3 Adjusting the Volume	34
3.4 Using Freeze Function	34
3.5 Android Functions.....	35
3.5.1 Accessing the Home Screen	35
3.5.2 Returning to the Previous Screen	35
3.5.3 Blanking the Screen	36
3.5.4 Activating the Writing Mode	36
3.6 Using the Touchscreen	37
3.7 Using the On-Screen Keyboard	41
CHAPTER 4: USING THE SYSTEM.....	42
4.1 About the Home Screen	42
4.2 Using the Assistive Menu	42
4.3 Using the Meetboard App.....	43
4.4 Using the Annotation App	47
4.5 Using the Finder app	47
4.6 Accessing Apps	48
4.7 Using the ScreenShare Pro App	49
4.8 Configuring System Settings	51
4.9 System Power Options.....	53
4.9.1 Wake On Source Option.....	53
4.9.2 Sleep Mode	53
CHAPTER 5: ON SCREEN DISPLAY MENU.....	54
5.1 Using the OSD Menu	54
5.2 OSD Menu Tree	55
CHAPTER 6: ADJUSTING THE INTERACTIVE DISPLAY	56
6.1 Audio Menu	56
6.2 Screen Menu	57
6.3 Display Menu.....	57
6.4 Adjust Menu.....	58
CHAPTER 7: APPENDIX.....	60
7.1 Warning Messages.....	60
7.2 Supported Media Formats.....	60
7.3 Supported Resolution.....	61
7.4 Troubleshooting.....	63
7.5 Transporting the Interactive Display	64
CHAPTER 8: SPECIFICATIONS	66
8.1 Display Specifications	66
8.2 Display Dimensions.....	67

SAFETY INFORMATION

Federal Communications Commission (FCC) Notice (U.S. Only)



This equipment has been tested and found to comply with the limits for a Class B digital device, pursuant to part 15 of the FCC Rules. These limits are designed to provide reasonable protection against harmful interference in a residential installation. This equipment generates, uses and can radiate radio frequency energy and, if not installed and used in accordance with the instructions, may cause harmful interference to radio communications. However, there is no guarantee that interference will not occur in a particular installation. If this equipment does cause harmful interference to radio or television reception, which can be determined by turning the equipment off and on, the user is encouraged to try to correct the interference by one or more of the following measures:

- Reorient or relocate the receiving antenna.
- Increase the separation between the equipment and receiver.
- Connect the equipment into an outlet on a circuit different from that to which the receiver is connected.
- Consult the dealer or an experienced radio/TV technician for help.



Changes or modifications not expressly approved by the party responsible for compliance could void the user's authority to operate the equipment.

Use only an RF shielded cable that was supplied with the display when connecting this display to a computer device.

To prevent damage which may result in fire or shock hazard, do not expose this appliance to rain or excessive moisture.

THIS CLASS B DIGITAL APPARATUS MEETS ALL REQUIREMENTS OF THE CANADIAN INTERFERENCE-CAUSING EQUIPMENT REGULATIONS.



This device complies with Part 15 of the FCC Rules. Operation is subject to the following two conditions: (1) this device may not cause harmful interference, and (2) this device must accept any interference received, including interference that may cause undesired operation.

Polish Center for Testing and Certification Notice

The equipment should draw power from a socket with an attached protection circuit (a three-prong socket). All equipment that works together (computer, display, printer, and so on) should have the same power supply source.

The phasing conductor of the room's electrical installation should have a reserve short-circuit protection device in the form of a fuse with a nominal value no larger than 16 amperes (A).

To completely switch off the equipment, the power supply cable must be removed from the power supply socket, which should be located near the equipment and easily accessible.

A protection mark "B" confirms that the equipment is in compliance with the protection usage requirements of standards PN-93/T-42107 and PN-89/E-06251.

SAFETY INFORMATION

Wymagania Polskiego Centrum Badań i Certyfikacji

Urządzenie powinno być zasilane z gniazda z przyłączonym obwodem ochronnym (gniazdo z kolkiem). Współpracujące ze sobą urządzenia (komputer, monitor, drukarka) powinny być zasilane z tego samego źródła.

Instalacja elektryczna pomieszczenia powinna zawierać w przewodzie fazowym rezerwową ochronę przed zwarciami, w postaci bezpiecznika o wartości znamionowej nie większej niż 16A (amperów).

W celu całkowitego wyłączenia urządzenia z sieci zasilania, należy wyjąć wtyczkę kabla zasilającego z gniazdką, które powinno znajdować się w pobliżu urządzenia i być łatwo dostępne.

Znak bezpieczeństwa "B" potwierdza zgodność urządzenia z wymaganiami bezpieczeństwa użytkownika zawartymi w PN-93/T-42107 i PN-89/E-06251.

Pozostałe instrukcje bezpieczeństwa

- Nie należy używać wtyczek adapterowych lub usuwać kolka obwodu ochronnego z wtyczki. Jeżeli konieczne jest użycie przedłużacza to należy użyć przedłużacza 3-żyłowego z prawidłowo połączonym przewodem ochronnym.
- System komputerowy należy zabezpieczyć przed nagłymi, chwilowymi wzrostami lub spadkami napięcia, używając eliminatora przepięć, urządzenia dopasowującego lub bezzakłóceńowego źródła zasilania.
- Należy upewnić się, aby nic nie leżało na kablach systemu komputerowego, oraz aby kable nie były umieszczone w miejscu, gdzie można byłoby na nie nadeptywać lub potykać się o nie.
- Nie należy rozlewać napojów ani innych płynów na system komputerowy.
- Nie należy wpychać żadnych przedmiotów do otworów systemu komputerowego, gdyż może to spowodować pożar lub porażenie prądem, poprzez zwarcie elementów wewnętrznych.
- System komputerowy powinien znajdować się z dala od grzejników i źródeł ciepła. Ponadto, nie należy blokować otworów wentylacyjnych. Należy unikać kładzenia luźnych papierów pod komputer oraz umieszczania komputera w ciasnym miejscu bez możliwości cyrkulacji powietrza wokół niego.

Electric, Magnetic and Electromagnetic Fields (E MF)

- We manufacture and sell many products targeted at consumers, which, like any electronic apparatus, in general have the ability to emit and receive electromagnetic signals.
- One of our leading Business Principles is to take all necessary health and safety measures for our products, to comply with all applicable legal requirements and to stay well within the EMF standards applicable at the time of producing the products.
- We are committed to develop, produce and market products that cause no adverse health effects.
- We confirm that if its products are handled properly for their intended use, they are safe to use according to scientific evidence available today.
- We play an active role in the development of international EMF and safety standards, enabling us to anticipate further developments in standardization for early integration in its products.

SAFETY INFORMATION

Information for U.K. only

WARNING - THIS APPLIANCE MUST BE EARTHED.

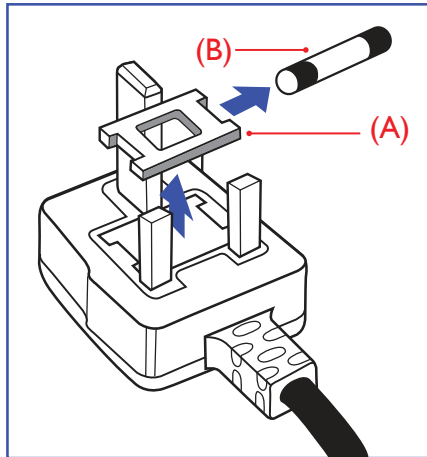

Important:

This apparatus is supplied with an approved moulded 13A plug. To change a fuse in this type of plug proceed as follows:

- 1 Remove fuse cover and fuse.
- 2 Fit new fuse which should be a BS 1362 5A, A.S.T.A. or BSI approved type.
- 3 Refit the fuse cover.

If the fitted plug is not suitable for your socket outlets, it should be cut off and an appropriate 3-pin plug fitted in its place.

If the mains plug contains a fuse, this should have a value of 5A. If a plug without a fuse is used, the fuse at the distribution board should not be greater than 5A.



Note:

The severed plug must be destroyed to avoid a possible shock hazard should it be inserted into a 13A socket elsewhere.

SAFETY INFORMATION

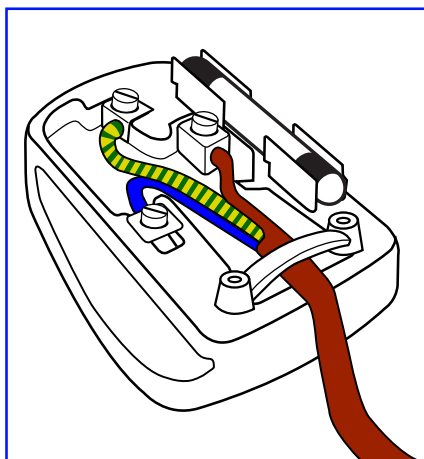

How to connect a plug

The wires in the mains lead are coloured in accordance with the following code:

BLUE - "NEUTRAL" ("N")

BROWN - "LIVE" ("L")

GREEN & YELLOW - "EARTH" ("E")

- The GREEN & YELLOW wire must be connected to the terminal in the plug which is marked with the letter "E" or by the Earth symbol or coloured GREEN or GREEN & YELLOW.
- The BLUE wire must be connected to the terminal which is marked with the letter "N" or coloured BLACK.
- The BROWN wire must be connected to the terminal which marked with the letter "L" or coloured RED.

Before replacing the plug cover, make certain that the cord grip is clamped over the sheath of the lead - not simply over the three wires.

North Europe (Nordic Countries) Information

Placering/Ventilation

WARNING: FÖRSÄKRA DIG OM ATT HUVUDBRYTARE OCH UTTAG ÄR LÄTÅTKOMLIGA, NÄR DU STÄLLER DIN UTRUSTNING PÅPLATS.

Placering/Ventilation

ADVARSEL: SØRG VED PLACERINGEN FOR, AT NETLEDNINGENS STIK OG STIKKONTAKT ER NEMT TILGÆ GELIGE.

Paikka/Ilmankierto

VAROITUS: SIJOITA LAITE SITEN, ETTÄ VERKKOJOHTO VOIDAAN TARVITTAESSA HELPOSTI IRROTTAA PISTORASIESTA.

Plassering/Ventilasjon

ADVARSEL: NÅR DETTE UTSTYRET PLASSERES, MÅ DU PASSE PÅ AT KONTAKTENE FOR STØMTILFØRSEL ER LETTE Å NÅ.

SAFETY INFORMATION

End-of-Life Disposal

Your new Public Information Display contains materials that can be recycled and reused. Specialized companies can recycle your product to increase the amount of reusable materials and to minimize the amount to be disposed of.

Please find out about the local regulations on how to dispose of your old display from your local dealer.

(For customers in Canada and U.S.A.)

This product may contain lead and/or mercury. Dispose of in accordance to local-state and federal regulations. For additional information on recycling contact www.eia.org (Consumer Education Initiative).

Waste Electrical and Electronic Equipment-WEEE

Attention users in European Union private households



This marking on the product or on its packaging illustrates that, under European Directive 2012/19/EU governing used electrical and electronic appliances, this product may not be disposed of with normal household waste. You are responsible for disposal of this equipment through a designated waste electrical and electronic equipment collection. To determine the locations for dropping off such waste electrical and electronic, contact your local government office, the waste disposal organization that serves your household or the store at which you purchased the product.

Attention users in United States:

Please dispose of according to all Local, State and Federal Laws. For the disposal or recycling information, contact: www.mygreenelectronics.com or www.eiae.org.

End of Life Directives-Recycling



Your new Public Information Display contains several materials that can be recycled for new users.

Please dispose of according to all Local, State, and Federal laws.

Restriction on Hazardous Substances statement (India)

This product complies with the "India E-waste Rule 2011" and prohibits use of lead, mercury, hexavalent chromium, polybrominated biphenyls or polybrominated diphenyl ethers in concentrations exceeding 0.1 weight % and 0.01 weight % for cadmium, except for the exemptions set in Schedule 2 of the Rule.

E-Waste Declaration for India



This symbol on the product or on its packaging indicates that this product must not be disposed of with your other household waste. Instead it is your responsibility to dispose of your waste equipment by handing it over to a designated collection point for the recycling of waste electrical and electronic equipment. The separate collection and recycling of your waste equipment at the time of disposal will help to conserve natural resources and ensure that it is recycled in a manner that protects human health and the environment.

SAFETY INFORMATION

Batteries



For EU: The crossed-out wheeled bin implies that used batteries should not be put to the general household waste! There is a separate collection system for used batteries, to allow proper treatment and recycling in accordance with legislation.

Please contact your local authority for details on the collection and recycling schemes.

For Switzerland: The used battery is to be returned to the selling point.

For other non-EU countries: Please contact your local authority for correct method of disposal of the used battery.

According to EU directive 2006/66/EC, the battery can't be disposed improperly. The battery shall be separated to collect by local service.

Turkey RoHS

Türkiye Cumhuriyeti: EEE Yönetmeliğine Uygundur.



Ukraine RoHS

Обладнання відповідає вимогам Технічного регламенту щодо обмеження використання деяких небезпечних речовин в електричному та електронному обладнанні, затвердженого постановою Кабінету Міністрів України від 3 грудня 2008 № 1057.

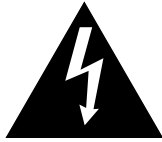
PRECAUTIONS



Symbols used in this manual

	This icon indicates the existence of a potential hazard that could result in personal injury or damage to the product.
	This icon indicates important operating and servicing information.

Notice

- Read this User Manual carefully before using the interactive display and keep it for future reference.
- The product specifications and other information provided in this User Manual are for reference only. All information is subject to change without notice. Updated content can be downloaded from our web site at displays.agneovo.com.
- To register online, go to displays.agneovo.com.
- To protect your rights as a consumer, do not remove any stickers from the interactive display. Doing so may affect the determination of the warranty period.

Cautions When Setting Up

- Do not place the interactive display near heat sources, such as a heater, exhaust vent, or in direct sunlight.
- Do not cover or block the ventilation holes in the housing.
- Place the interactive display on a stable area. Do not place the interactive display where it may subject to vibration or shock.
- Place the interactive display in a well-ventilated area.
- Do not place the interactive display outdoors.
- To avoid the risk of shock or permanent damage to the set, do not expose the display to dust, rain, water or an excessively moist environment.
- Do not spill liquid or insert sharp objects into the interactive display through the ventilation holes. Doing so may cause accidental fire, electric shock or damage the interactive display.

PRECAUTIONS

Cautions When Using

- Use only the power cord supplied with the interactive display.
- The power outlet should be installed near the interactive display and be easily accessible.
- If an extension cord is used with the interactive display, ensure that the total current consumption plugged into the power outlet does not exceed the ampere rating.
- Do not allow anything to rest on the power cord. Do not place the interactive display where the power cord may be stepped on.
- If the interactive display will not be used for an indefinite period of time, unplug the power cord from the power outlet.
- To disconnect the power cord, grasp and pull by the plug head. Do not tug on the cord; doing so may cause fire or electric shock.
- Do not unplug or touch the power cord with wet hands.
- When turning off the display by detaching the power cord, wait 6 seconds before re-attaching the power cord for normal operation.
- Do not knock or drop the display during operation or transportation.

Cleaning and Maintenance

- To protect your display from possible damage, do not put excessive pressure on the LCD panel. When moving your display, grasp the frame to lift; do not lift the display by placing your hand or fingers on the LCD panel.
- For cleaning the touch screen, refer to page 9.
- If your display becomes wet, wipe it with dry cloth as soon as possible.
- If a foreign substance or water gets in your display, turn the power off immediately and disconnect the power cord. Then remove the foreign substance or water, and send the unit to the maintenance center.
- In order to maintain the best performance of your display and ensure a longer lifetime, we strongly recommend using the display in a location that falls within the following temperature and humidity ranges.
 - ◆ Temperature: 0°C-40°C (32°F-104°F)
 - ◆ Humidity: 10%-90% (non-condensing)



Warning:



Unplug the power cord from the power outlet and refer to qualified service

personnel under the following conditions:

- ◆ When the power cord is damaged.
- ◆ If the interactive display has been dropped or the housing has been damaged.
- ◆ If the interactive display emits smoke or a distinct odor.

PRECAUTIONS

Notice for the Interactive Display

- In order to maintain the stable luminous performance, it is recommended to use low brightness setting.
- Due to the lifespan of the lamp, it is normal that the brightness quality of the interactive display may decrease with time.
- When static images are displayed for long periods of time, the image may cause an imprint on the interactive display. This is called image retention or burn-in.
 - ◆ To prevent image retention, do any of the following:
 - Set the interactive display to turn off after a few minutes of being idle.
 - Use a screen saver that has moving graphics or a blank white image.
 - Switch desktop backgrounds regularly.
 - Adjust the interactive display to low brightness settings.
 - Turn off the interactive display when the system is not in use.
 - ◆ Things to do when the interactive display shows image retention:
 - Turn off the interactive display for extended periods of time. It can be several hours or several days.
 - Use a screen saver and run it for extended periods of time.
 - Use a black and white image and run it for extended periods of time.
- There are millions of micro transistors inside the interactive display. It is normal for a few transistors to be damaged and to produce spots. This is acceptable and is not considered a failure.
- **IMPORTANT:** Always activate a moving screen saver program when you leave your display unattended. Always activate a periodic screen refresh application if the unit will display unchanging static content. Uninterrupted display of still or static images over an extended period may cause “burn in”, also known as “after-imaging” or “ghost imaging”, on your screen. This is a well-known phenomenon in LCD panel technology. In most cases, the “burned in” or “after-imaging” or “ghost imaging” will disappear gradually over a period of time after the power has been switched off.
- **WARNING:** Severe “burn-in” or “after-image” or “ghost image” symptoms will not disappear and cannot be repaired. This is also not covered under the terms of your warranty.

Caring for the Touch Screen

Use the following recommendations to care for the touch screen.

- Before cleaning the screen, make sure the interactive display is switched off and the power cord is unplugged from the wall outlet.
- Remove dirt or dust from the screen regularly. It is recommended to use a small amount of alcohol as cleaning agent.
- To avoid damage to the screen, never use any aggressive solvents or scrubbing agents.
- Wipe the screen gently using a lint-free cloth moistened in the cleaning agent.
- Never spray the cleaning agent on the screen surface or the body directly as it may cause short circuit to the touch screen.
- Do not expose the display to direct sunlight or strong light source during use.

CHAPTER 1: PRODUCT DESCRIPTION

1.1 Unpacking

- This product is packed in a packaging box which contains standard accessories.
- Any other optional accessories will be packed separately.
- Considering the size and weight of the display, it is recommended that this product is carried out by two persons.
- After opening the packaging box, ensure that the included items are in good condition and complete.

1.2 Package Contents

When unpacking, check if the following items are included in the package. If any of them is missing or damaged, contact your dealer.

Interactive Display

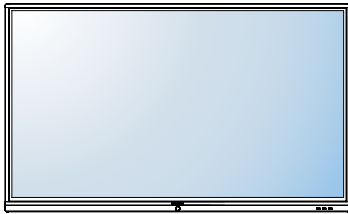

Remote Control

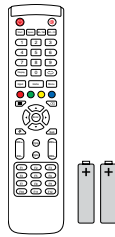

Quick Start Guide



HDMI Cable

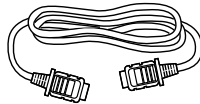

**USB Cable
(for touch control)**

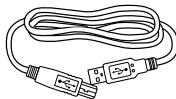

**Power Cord
(EU/UK/US/TW)**

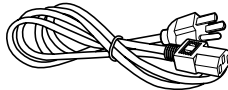

Touch Pen x 2



Wi-Fi Module

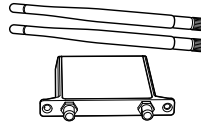

Wall Mount

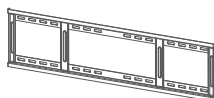

**Wall Mount
Installation Guide**

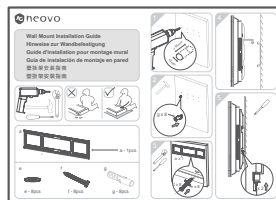

**Wall Mount Screw
Package**

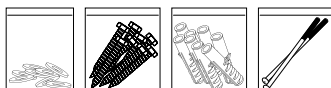

Note:

- ◆ Remote control is shipped with the supplied AAA batteries.
- ◆ For all other regions, apply a power cord that conforms to the AC voltage of the power socket and has been approved by and complies with the safety regulations of the particular country (Type H05W-F, 2G or 3G, 0.75 or 1 mm² should be used).
- ◆ You might like to save the package box and packing material for shipping the display.
- ◆ The pictures are for reference only. Actual items may vary upon shipment.

PRODUCT DESCRIPTION

1.3 Preparing for the Installation

- Due to the high power consumption, always use the plug exclusively designed for this product. If an extended line is required, please consult your service agent.
- The product should be installed on a flat surface to avoid tipping. The distance between the back of the product and the wall should be maintained for proper ventilation. Avoid installing the product in the kitchen, bathroom or any other places with high humidity so as not to shorten the service life of the electronic components.
- The product can normally operate only under 3600m in altitude. In installations at altitudes above 3600m, some abnormalities may be experienced.

1.4 Wall Mounting Installation

To mount this display to a wall, you will have to obtain a standard wall-mounting kit (commercially available). We recommend using a mounting interface that complies with TUV-GS and/or UL1678 standard in North America.

To wall-mount the interactive display, screw the mounting bracket to the VESA holes at the rear of the interactive display.

IFP-6502

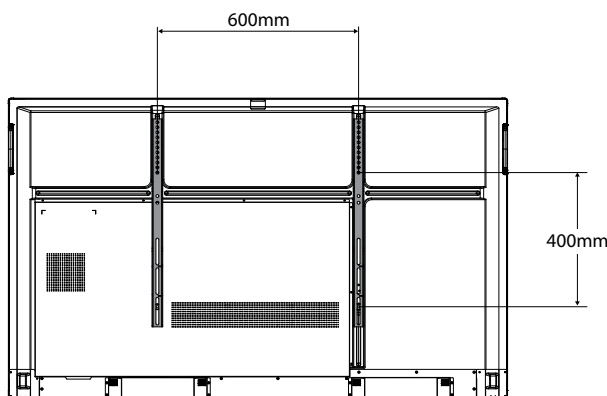

IFP-7502

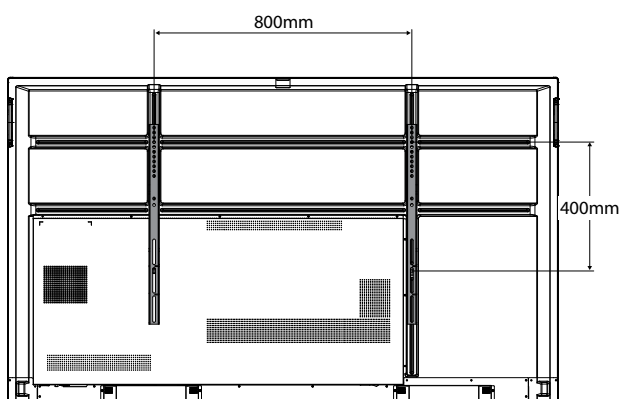

Warning:

- ◆ Do not press too hard on the LCD panel or edge of the frame, as this may cause the device to malfunction.

Note:

- ◆ Avoid the wall-mounting kit to block the ventilation holes on the back of the display.
- ◆ Secure the interactive display on a solid wall strong enough to bear its weight.
- ◆ Lay a protective sheet on a table, which was wrapped around the display when it was packaged, beneath the screen surface so as not to scratch the screen face.
- ◆ Ensure you have all accessories for mounting this display (wall mount, ceiling mount, etc).
- ◆ Follow the instructions that come with the base mounting kit. Failure to follow correct mounting procedures could result in damage to the equipment or injury to the user or installer. Product warranty does not cover damage caused by improper installation.

PRODUCT DESCRIPTION

IFP-8602

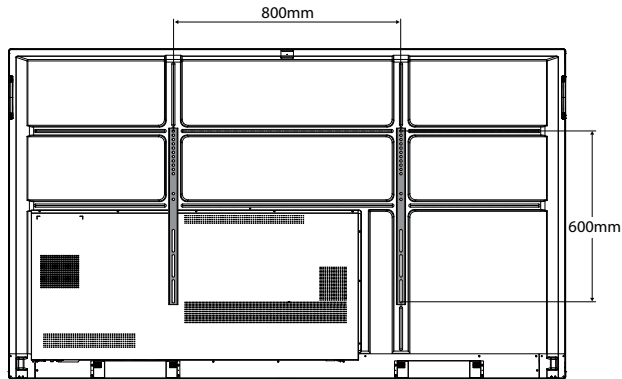

1.4.1 VESA Grid

Model Name	VESA Grid
IFP-6502	600(W) x 400(H)mm
IFP-7502	800(W) x 400(H)mm
IFP-8602	800(W) x 600(H)mm

Caution:

To prevent the display from falling:

- ◆ For wall or ceiling installation, we recommend installing the display with metal brackets which are commercially available. For detailed installation instructions, see the guide received with the respective bracket.
- ◆ To lessen the probability of injury and damage resulting from fall of the display in case of earthquake or other natural disaster, be sure to consult the bracket manufacturer for installation location.

1.4.2 Mounting the Interactive Display on the Wall

To mount the interactive display on the wall, you need the following items:

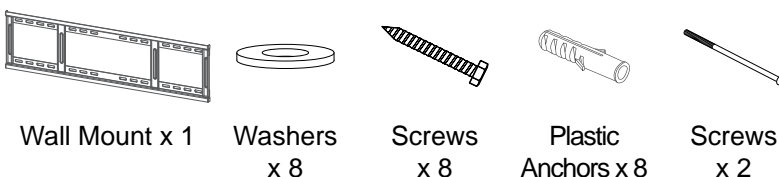

- 1 Drill eight small holes on the mounting location with the length and width 55mm x 10mm respectively.

Note:

- ◆ For the wall-mounting kit, use M6 mounting screws (having a length 10 mm longer than the thickness of the mounting bracket) and tighten them securely.
- ◆ Unit without base weight:
IFP-6502=39.0 kg /
IFP-7502=50.6 kg /
IFP-8602=66.0 kg.
The equipment and its associated mounting means still remain secure during the test. For use only with UL Listed Wall Mount Bracket with minimum weight/load:
IFP-6502=48.8 kg /
IFP-7502=62.7 kg /
IFP-8602=81.2 kg.

PRODUCT DESCRIPTION

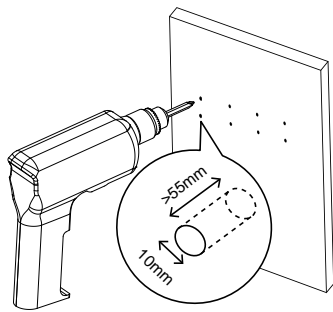

- 2 Insert a plastic anchor into each hole.

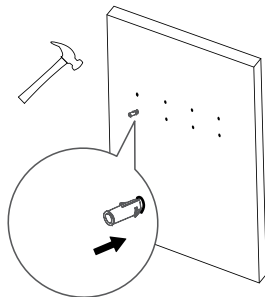

- 3 Secure the wall mount with the eight supplied screws through the washers into the eight installed anchors on the wall.

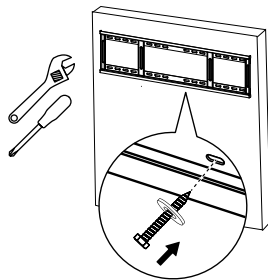

- 4 Align and hook the dual wall mount on the interactive display to the wall mount.

Dual Wall Mount x 2

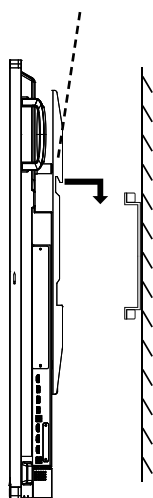

PRODUCT DESCRIPTION

- 5 Secure the dual wall mount and the wall mount with the two screws.

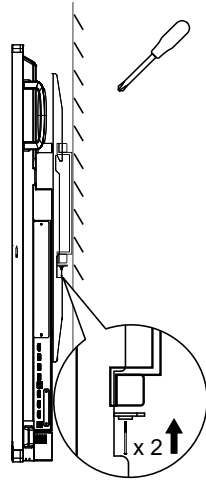

1.4.3 Ventilation Requirements for Enclosure Locating

To allow heat to disperse, leave space between surrounding objects as shown in the diagram below.

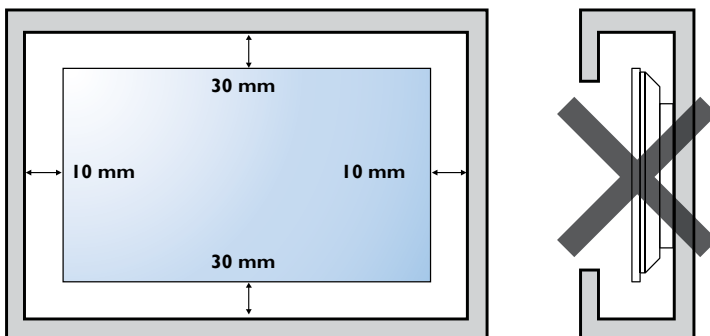

1.5 Installing the Wi-Fi Module

To use wireless connectivity, you need to install the Wi-Fi module to the interactive display.

- 1 Remove the two screws from the Wi-Fi module slot cover.

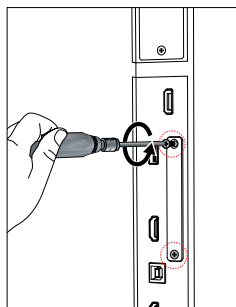

Note:

- ◆ Keep clearances around the interactive display according to the minimum dimensions as illustrated.
- ◆ Never cover the ventilation holes or insert anything into the housing.
- ◆ Do not place the interactive display in a confined space, such as a cabinet or imbedded closet. Place the display on a sturdy, level surface and make sure an appropriate ventilation is provided.



Warning:

Make sure the power cord of the interactive display is disconnected before the installation.

PRODUCT DESCRIPTION

- 2 Remove the Wi-Fi module slot cover.

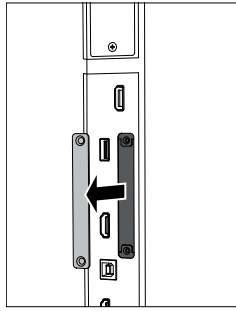

- 3 With the antenna connectors facing out, install the Wi-Fi module into its slot in the interactive display. Secure the Wi-Fi module to the interactive display with the two screws.

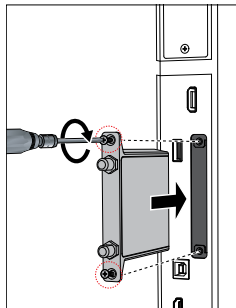

- 4 Connect the antenna to either of the antenna connectors on the Wi-Fi module and secure it by rotating the antenna clockwise.

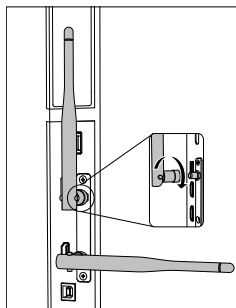

- 5 Repeat step 4 for the second antenna.

PRODUCT DESCRIPTION

1.6 Interactive Display Overview

1.6.1 Control Panel

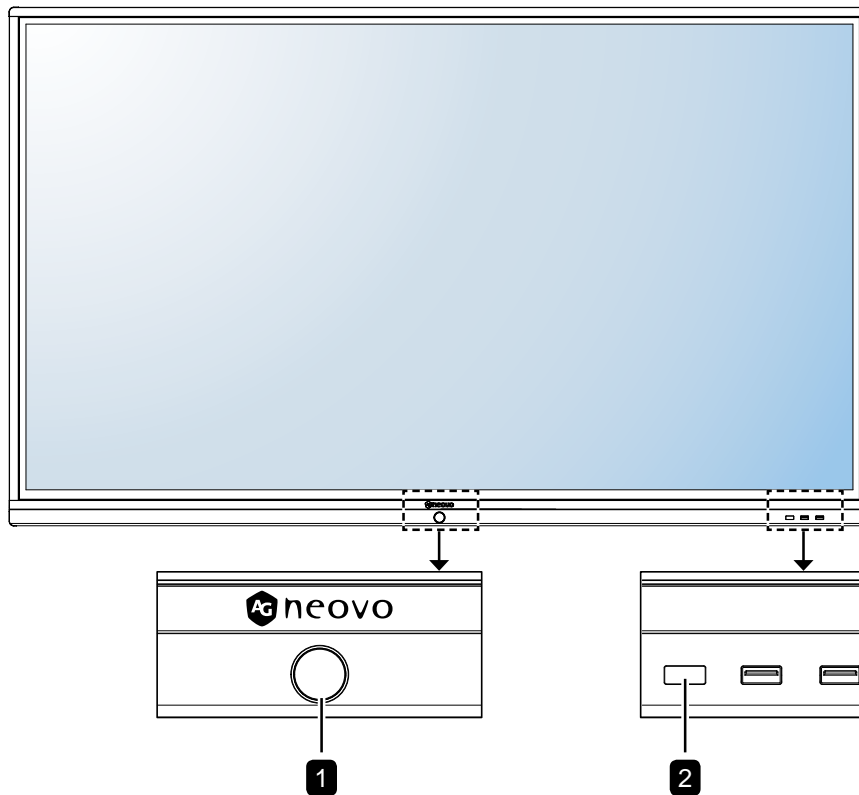

1 [⏻] POWER button with LED indicator

- Short press (<3 seconds) to turn the display on or off without shutting down the system.
- Long press (>3 seconds) to shut down the system.

LED indicator:

- Blue: The system is turned on.
- Blue/Red Flashing: The system is in power saving mode.
- Red: The system is shut down.

2 Remote control sensor

Receives command signals from the remote control.

PRODUCT DESCRIPTION

1.6.2 Input/Output Terminals

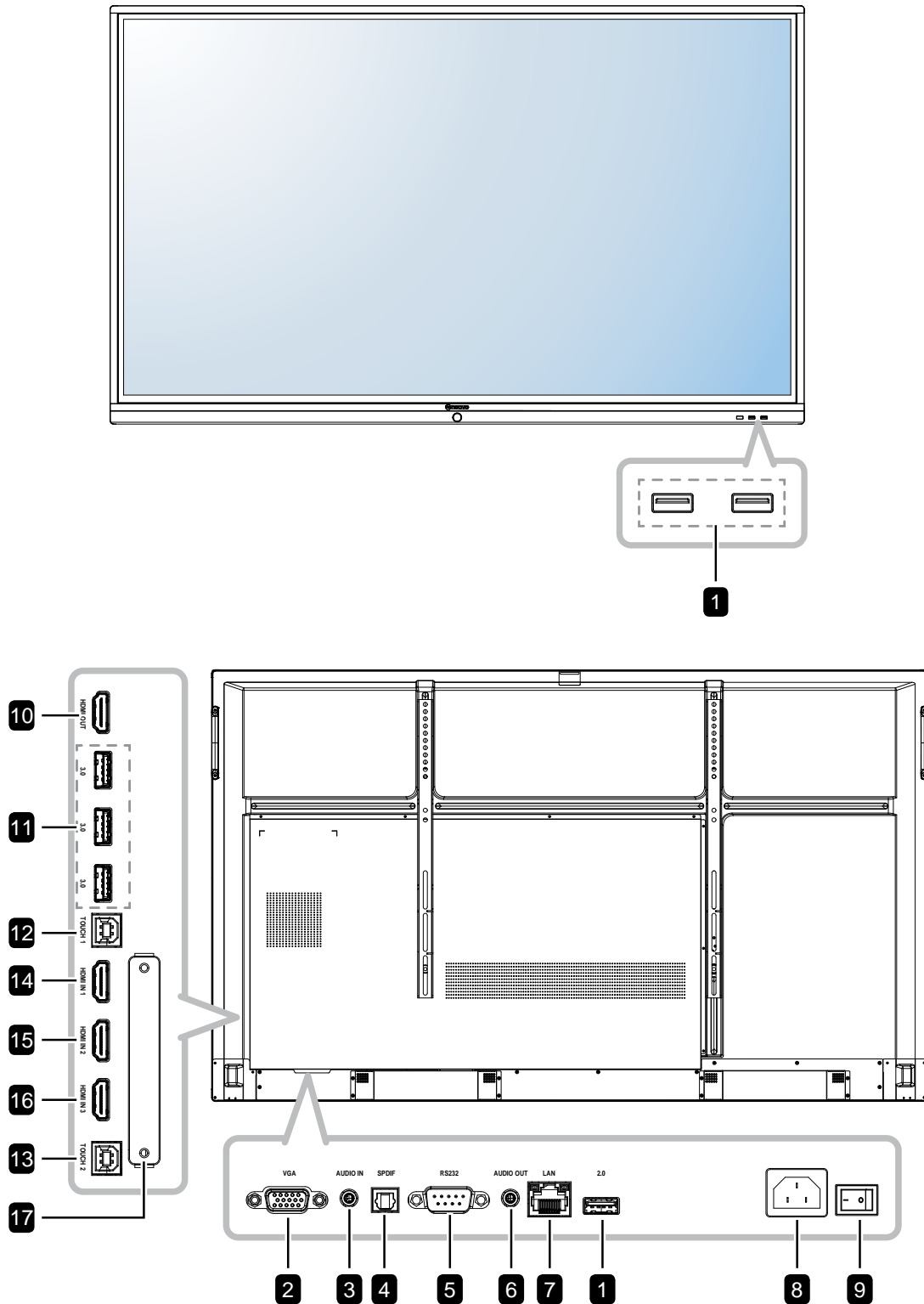

PRODUCT DESCRIPTION

- 1 USB 2.0**
Connect to a USB interface device.
- 2 VGA IN**
Connect VGA signals input.
- 3 AUDIO IN**
Connect audio signals input (3.5 mm Stereo Audio Jack).
- 4 S/PDIF OUT**
Connect digital audio signals output.
- 5 RS232 IN**
Connect RS232 input from external equipment.
- 6 AUDIO OUT**
Connect audio signals output (3.5 mm Stereo Audio Jack).
- 7 LAN**
For internet connection with an Ethernet cable.
- 8 ~**
AC power input
- 9 Main Power**
Switch the main power on/off.
- 10 HDMI OUT**
Connect HDMI signals output.
- 11 USB 3.0**
Connect to a USB interface device.
- 12 Touch 1 (USB Type-B)**
Connect USB for touch screen control.
- 13 Touch 2 (USB Type-B)**
Connect USB for touch screen control.
- 14 HDMI IN 1**
Connect HDMI signals input.
- 15 HDMI IN 2**
Connect HDMI signals input.
- 16 HDMI IN 3**
Connect HDMI signals input.
- 17 WIFI Slot**
Connect the Wi-Fi module.

PRODUCT DESCRIPTION

1.7 Remote Control

1.7.1 General Functions

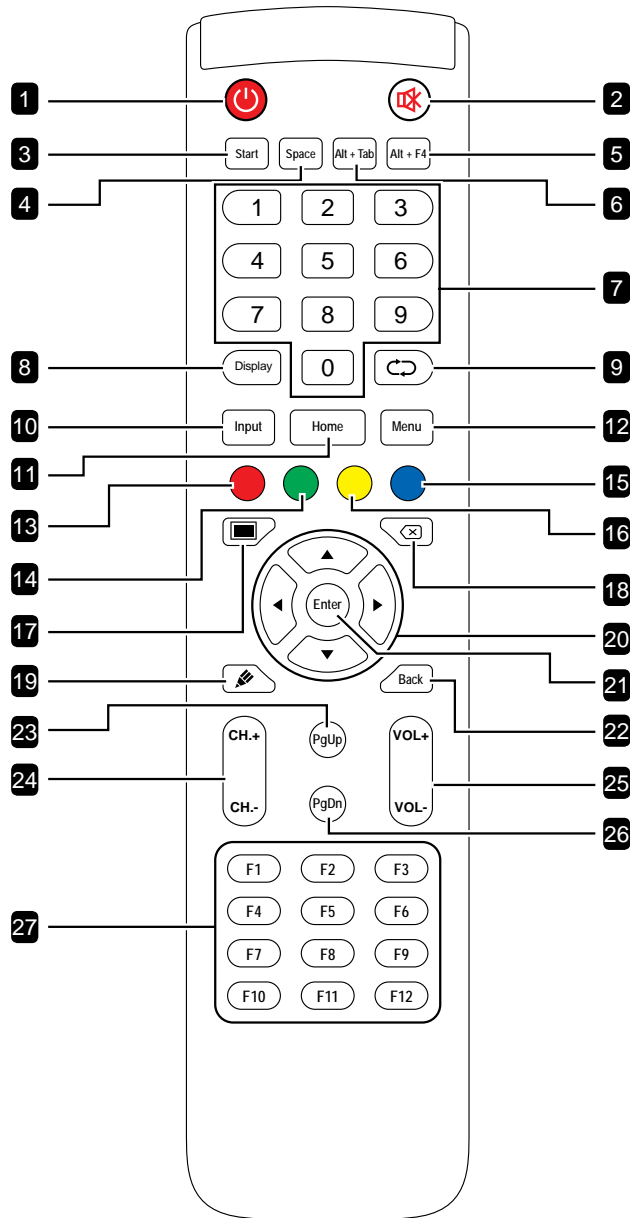

- 1 [Power] Power button:**
Turns the system on or shuts down.
- 2 [MUTE] MUTE button:**
Turns the mute function on or off.
- 3 [START] Start button:**
Opens the Start menu (Windows OS).
- 4 [SPACE] Space button:**
Functions as "Space" keyboard key.
- 5 [Alt + F4] "Alt"+"F4" button:**
Functions as "Alt"+"F4" keyboard keys (Window OS).
- 6 [Alt + Tab] "Alt"+"Tab" button:**
Functions as "Alt"+"Tab" keyboard keys (Window OS).
- 7 [Number] Number buttons:**
Enters numbers.
- 8 [Display] Display button:**
Displays channel information.
- 9 [Re-sync] Re-sync button:**
Not supported.
- 10 [Input] Source button:**
Opens TouchMenu>General Setting.
- 11 [Home] Home button:**
Returns to the Home screen (Android OS).
- 12 [Menu] Menu button:**
Opens TouchMenu>Audio.
- 13 [Red] Red button:**
Enables or disables the Front keyboard and Touch function.
- 14 [Green] Green button:**
Enables or disables the Front keyboard.
- 15 [Blue] Blue button:**
Opens or closes the screen freezing tools.
- 16 [Yellow] Yellow button:**
Enables or disables the Touch function.
- 17 [Screen backlight] Screen backlight button:**
Turn on or off the screen backlight.
- 18 [Backspace] Backspace button:**
Functions as "Backspace" keyboard key.
- 19 [Writing mode] Writing mode button:**
Switches the system into Writing mode.
- 20 [Navigation] Navigation buttons:**
Navigates through the OSD menu and adjusts the settings.

PRODUCT DESCRIPTION

21 [Enter] Enter button:

Confirms your selection or saves the modifications.

22 [Back] Back button:

Returns to the previous screen (Android OS).

23 [PgUp] Page Up button:

Functions as "PageUp" keyboard key.

24 [CH.+] [CH.-] Channel button:

No function.

25 [VOL+] [VOL-] Volume button:

Adjusts volume on internal or external audio sources.

26 [PgDn] Page Down button:

Functions as "PageDown" keyboard key.

27 [F1-F12] F1-F12 buttons:

Function as "F1" to "F12" keyboard keys (Windows OS).

Note:

- ◆ While the interactive display is powered on and you press the keyboard button, the **POWER** button LED indicator blinks red once and then turns back blue.

PRODUCT DESCRIPTION

1.7.2 Inserting the Batteries in the Remote Control

The remote control is powered by two 1.5V AAA batteries.

To install or replace batteries:

- 1 Unlatch and then remove the battery compartment cover.
- 2 Align the batteries according to the (+) and (-) indications inside the battery compartment.
- 3 Replace the battery compartment cover.

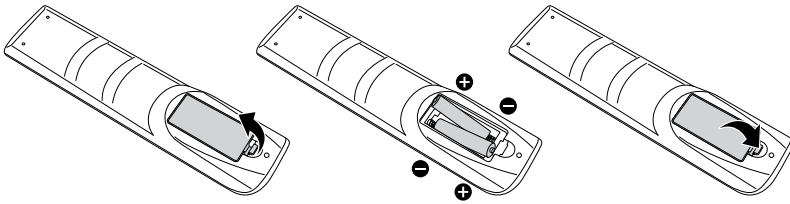

1.7.3 Handling the Remote Control

- Do not subject to strong shock.
- Do not allow water or other liquid to splash the remote control. If the remote control gets wet, wipe it dry immediately.
- Avoid exposure to heat and steam.
- Other than to install the batteries, do not open the remote control.

Caution:

The incorrect use of batteries can result in leaks or bursting. Be sure to follow these instructions:

- ◆ Place “AAA” batteries matching the (+) and (-) signs on each battery to the (+) and (-) signs of the battery compartment.
- ◆ Do not mix battery types.
- ◆ Do not combine new batteries with used ones. It causes shorter life or leakage of batteries.
- ◆ Remove the dead batteries immediately to prevent them from liquid leaking in the battery compartment. Don't touch exposed battery acid, as it can damage your skin.

Note:

- ◆ If you do not intend to use the remote control for a long period, remove the batteries.
- ◆ The remote control may not function properly when the remote control sensor on this display is under direct sunlight or strong illumination, or when there is an obstacle in the path of signal transmission.

PRODUCT DESCRIPTION

1.7.4 Operating Range of the Remote Control

Point the top of the remote control toward the display's remote control sensor (on the left or right side) when pressing a button.

When using the remote control, the distance from the remote control to the sensor on the display should be less than 8m/26ft, and the horizontal and vertical angles should be less than 30°.

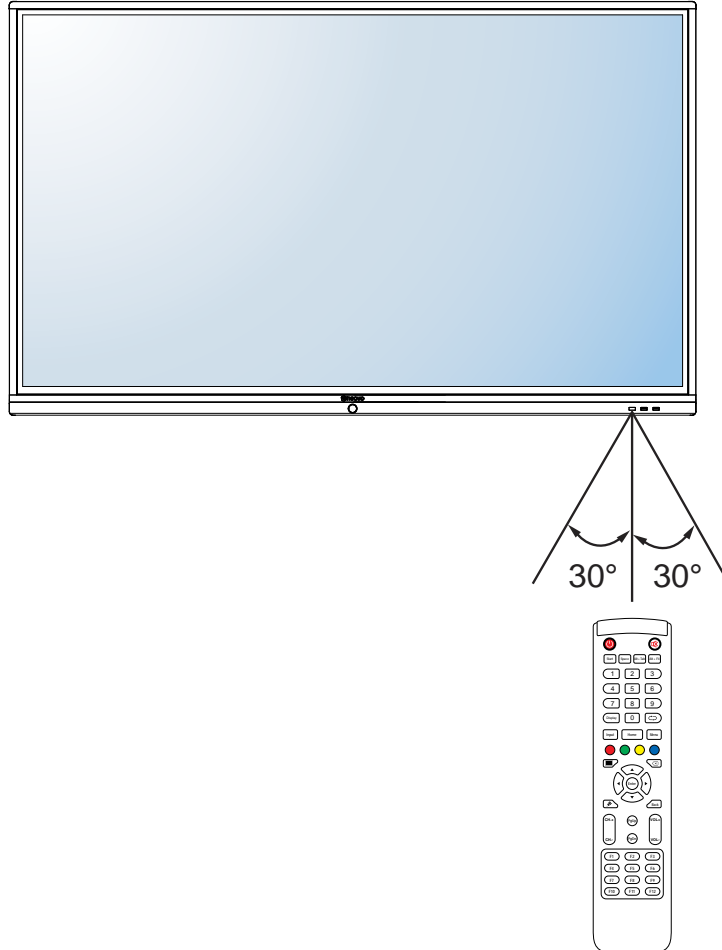

CHAPTER 2: MAKING CONNECTIONS

2.1 Connecting the Power

Note:

- ◆ To operate the interactive display, ensure to use the correct power cord that matches the power outlet in your region.
- 1 Connect one end of the power cord to the AC IN connector on the interactive display.
 - 2 Connect the other end of the power cord to a power outlet or a power supply.
 - 3 Set the **Main Power** switch to ON.

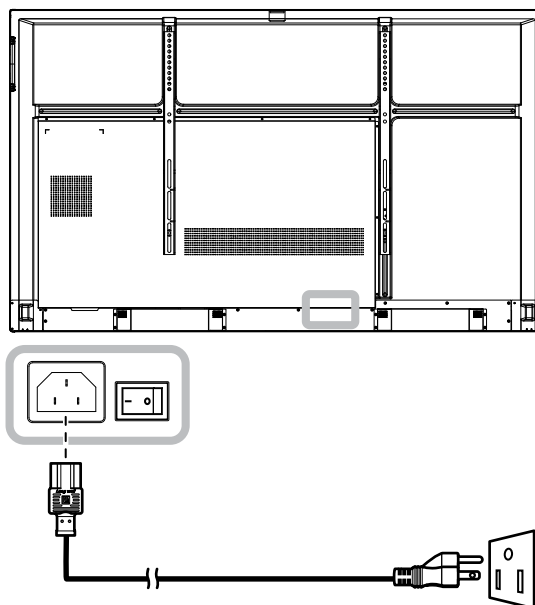

⚡ Caution:

- ◆ Make sure that the interactive display is not connected to the power outlet before making any connections. Connecting cables while the power is ON may cause electric shock or personal injury.
- ◆ When unplugging the power cord, hold the power cord by the plug head. Never pull by the cord.

MAKING CONNECTIONS

2.2 Connecting a Computer or Portable Device

2.2.1 Using VGA (D-Sub) Input

Connect one end of a VGA cable to the VGA connector of the interactive display and the other end of a VGA cable to the VGA OUT connector of the computer.

For audio input, connect one end of an audio cable to the AUDIO IN connector of the interactive display and the other end of an audio cable to the AUDIO OUT connector of the computer.

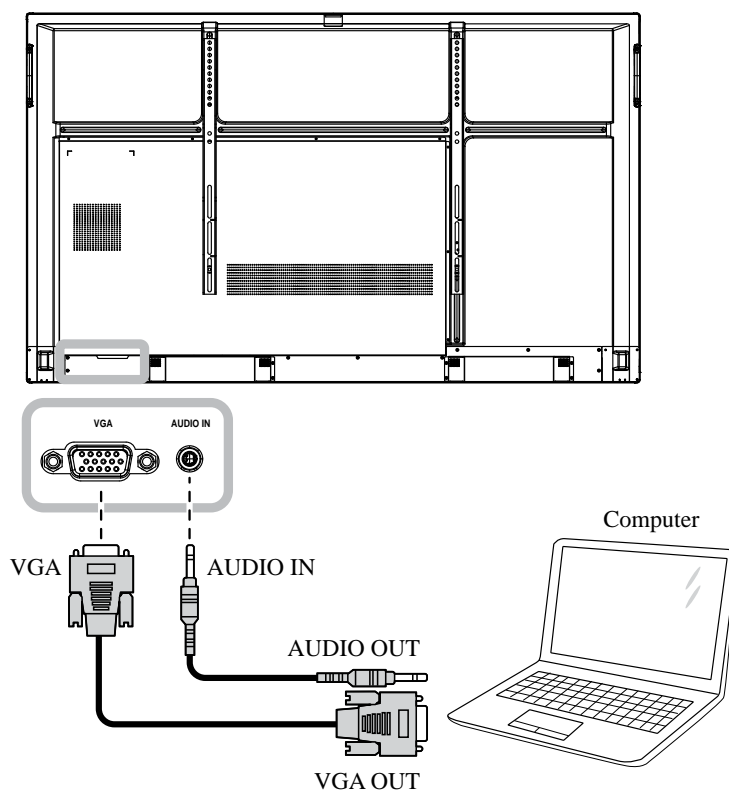

MAKING CONNECTIONS

2.2.2 Using RS232 Input

Connect one end of a RS232 serial cable to the RS232 connector of the interactive display and the other end of an RS232 serial cable to the RS232 connector of the computer.

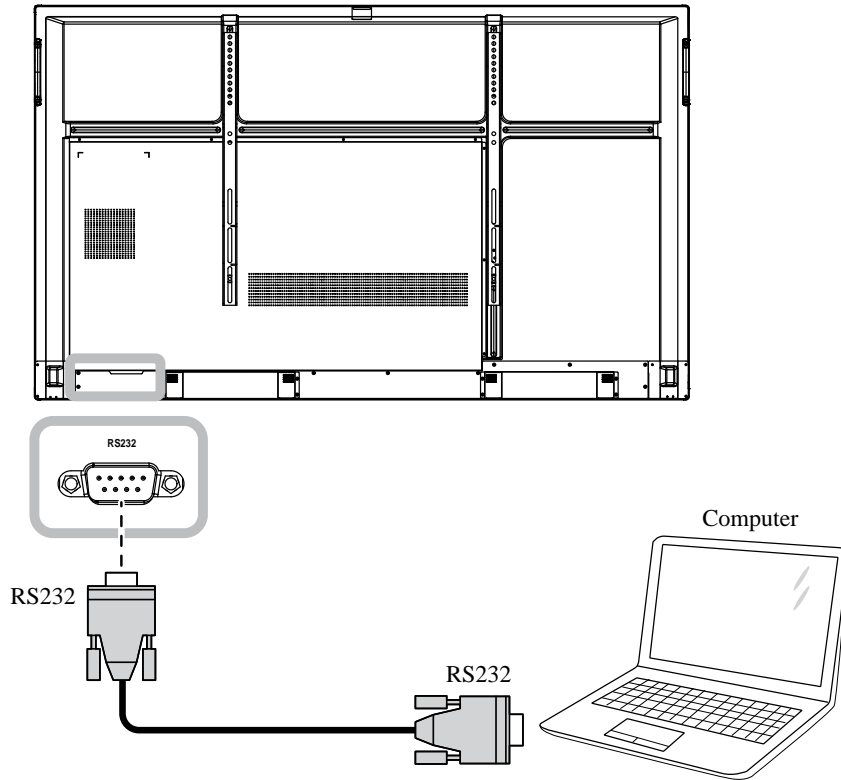

2.2.3 Using HDMI Input

Connect one end of an HDMI cable to the HDMI IN 1, HDMI IN 2, or HDMI IN 3 connector of the interactive display and the other end of an HDMI cable to the HDMI OUT connector of the computer.

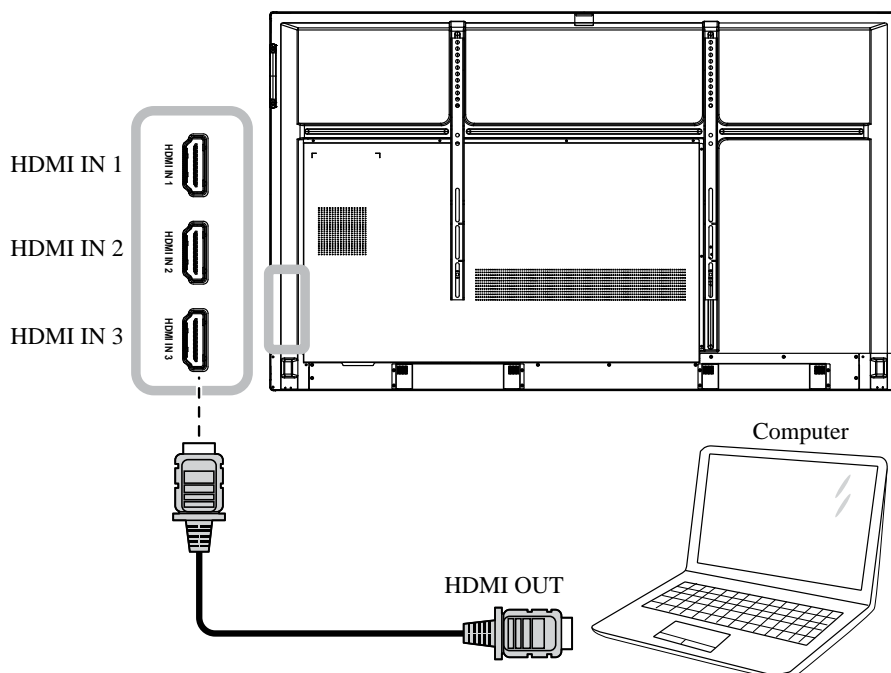

MAKING CONNECTIONS

2.2.4 Using the Touch Module

Interactive display has touch screen functionality which allows you to connect a computer to the display and control the computer's interface via touch gestures on the display. To use this touch screen function, connect the USB cable to the TOUCH 1 or TOUCH 2 port of the display and a computer.

In addition, perform the following connection:

- For TOUCH 1, connect one end of the HDMI cable to the HDMI IN 1 or HDMI IN 2 port of the display and the other end of the HDMI cable to the HDMI OUT port of the computer.
- For TOUCH 2, connect one end of the HDMI cable or VGA cable to the HDMI IN 3 port or VGA port of the display and the other end of the HDMI cable or the VGA cable to the HDMI OUT port or VGA OUT port of the computer respectively.

For compatibility options, refer to the following table:

	HDMI IN 1	HDMI IN 2	HDMI IN 3	VGA
TOUCH 1	○	○	X	X
TOUCH 2	X	X	○	○

TOUCH 1

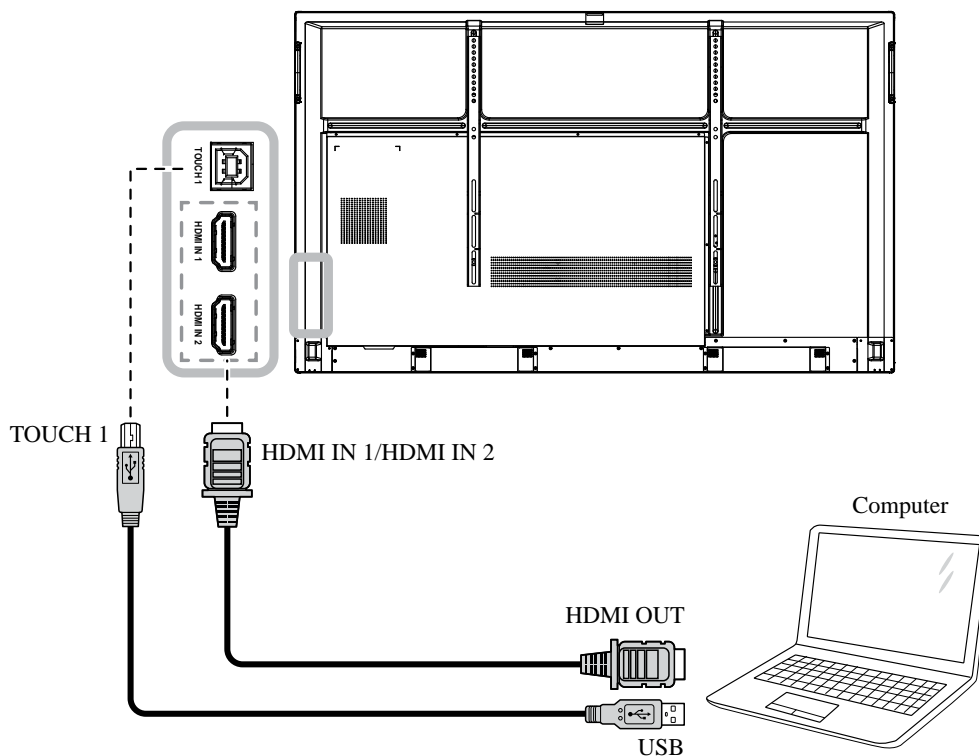

MAKING CONNECTIONS

2.3 Connecting External Equipment (Video Player)

Connect one end of an HDMI cable to the HDMI IN 1, HDMI IN 2, or HDMI IN 3 connector of the interactive display and the other end of an HDMI cable to the HDMI OUT connector of the video player.

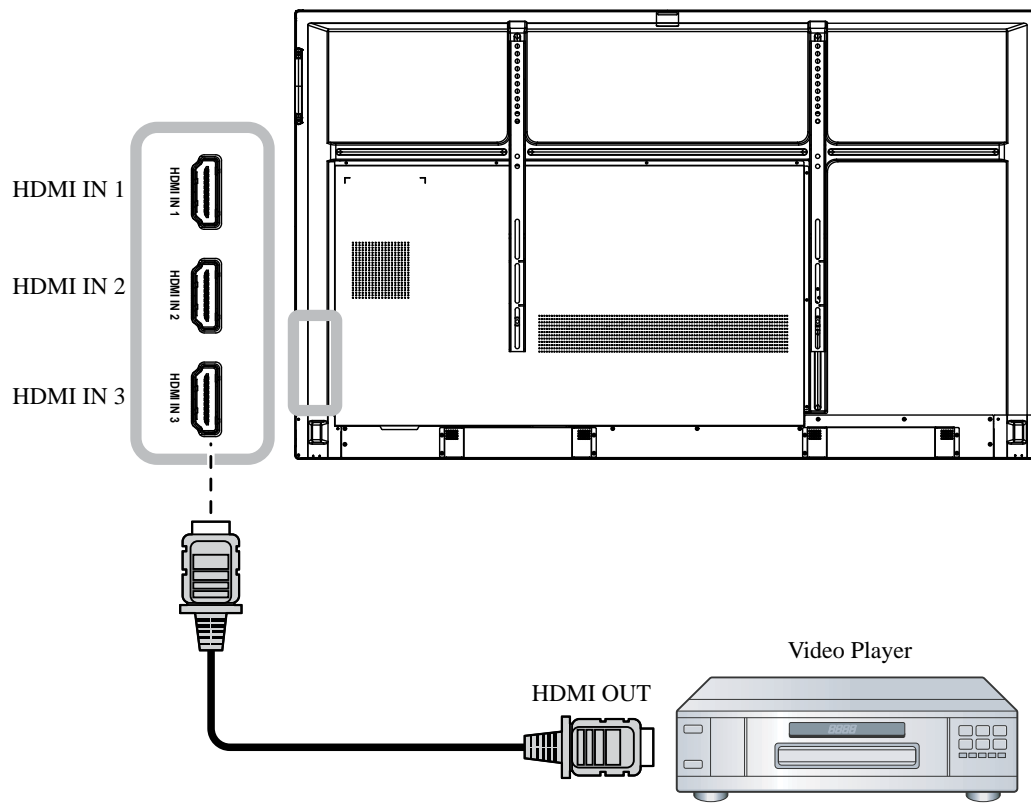

MAKING CONNECTIONS

2.4 Connecting a Display Device

Connect one end of an HDMI cable to the HDMI OUT connector of the interactive display and the other end of an HDMI cable to the HDMI IN connector of the display device.

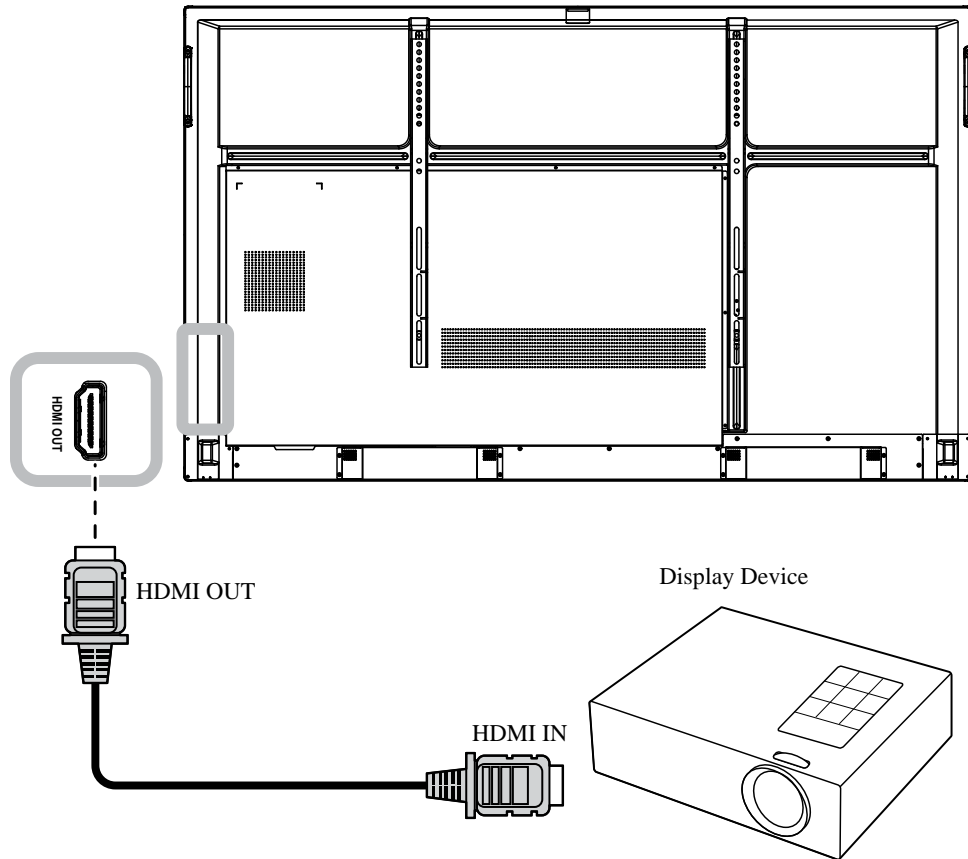

MAKING CONNECTIONS

2.5 Connecting to a Wired Network

Connect one end of a network cable (R4 5) to the LAN connector of the interactive display and the other end of a network cable to a network hub, switch, or router.

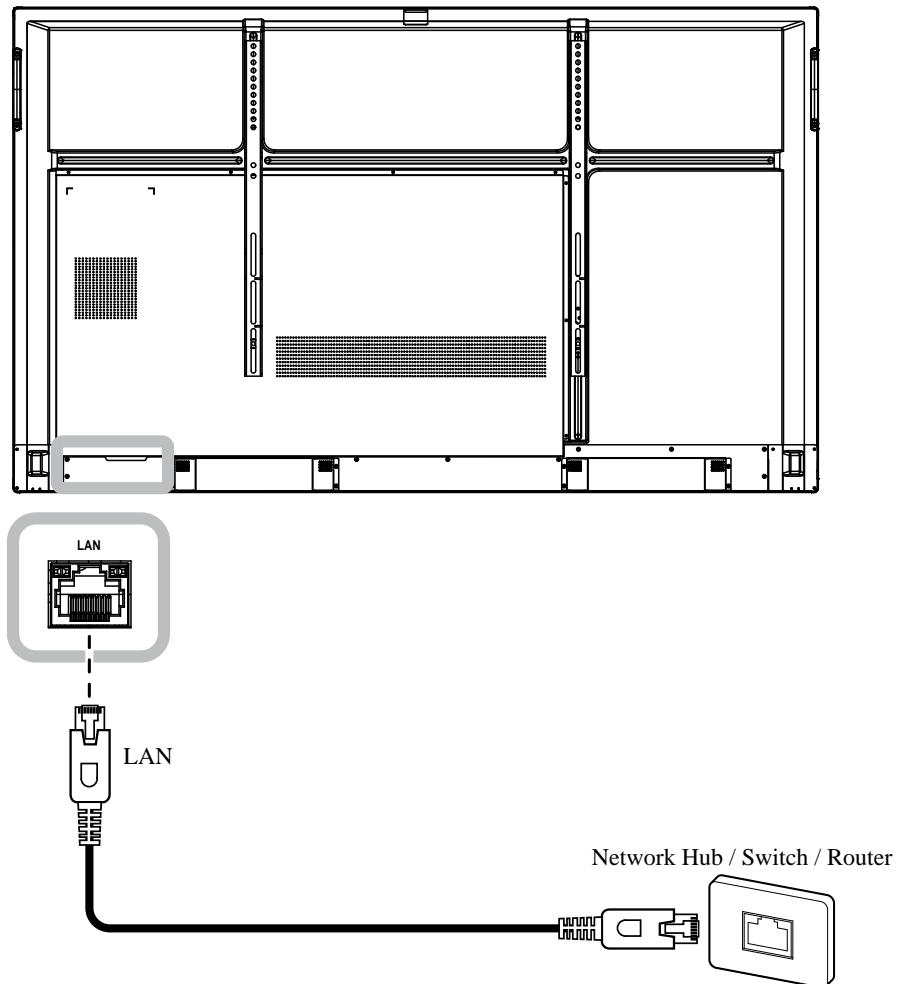

MAKING CONNECTIONS

2.6 Connecting USB Interface Devices

Connect a USB interface device to USB2.0 or USB3.0 ports of the interactive display.

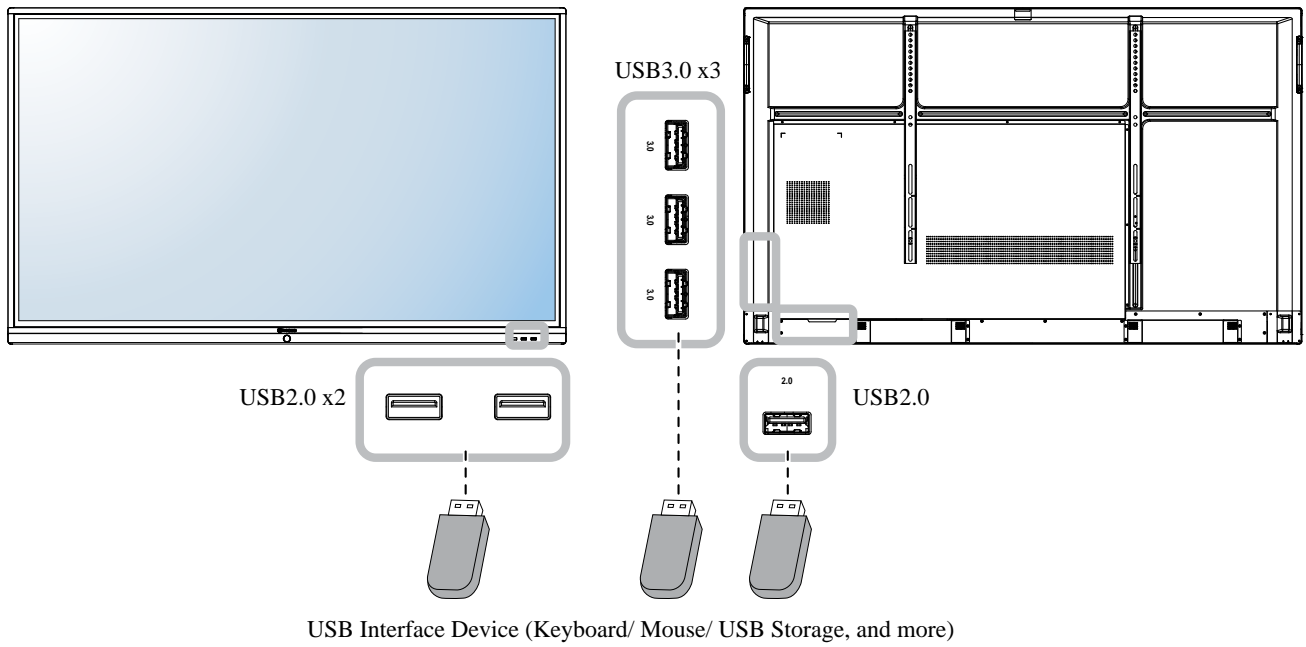

MAKING CONNECTIONS

2.7 Connecting Audio Equipment

Connect one end of an audio cable to the AUDIO OUT connector of the interactive display and the other end of an audio cable to the AUDIO IN connector of the audio device.

For digital audio output, connect one end of an audio cable to the SPDIF connector of the interactive display and the other end of an audio cable to the SPDIF IN connector of the audio device.

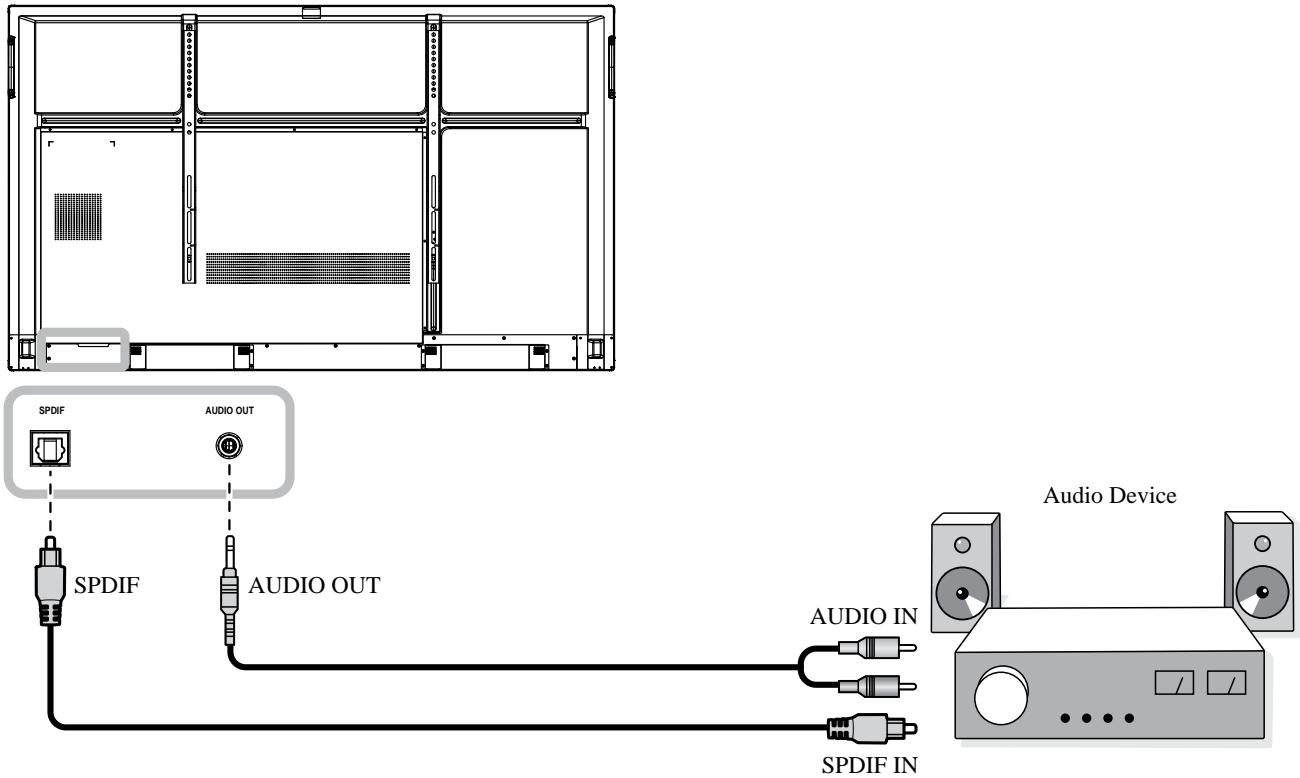

CHAPTER 3: USING THE INTERACTIVE DISPLAY

3.1 Turning on the Power

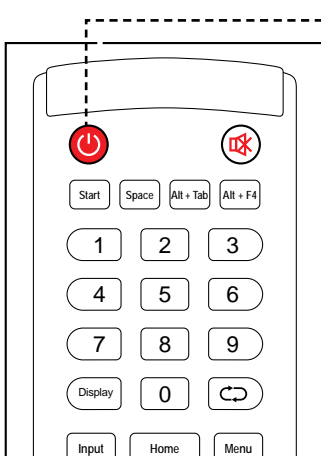

- 1 Plug the power cord to a power outlet or power supply.
- 2 Set the **Main Power** switch to ON.
- 3 Press the  button to turn the interactive display on.



When the interactive display is turned on, press the  button to turn off the interactive display.

Note:

- ◆ The interactive display still consumes power as long as the power cord is connected to the power outlet. Disconnect the power cord to completely cut off power.

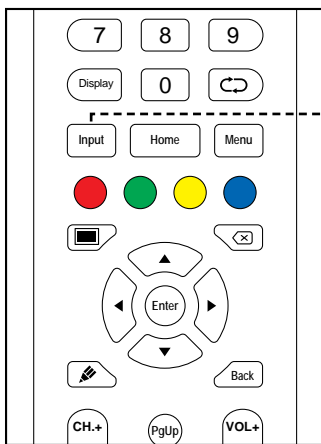
3.2 Selecting the Input Source Signal



- 1 Press the **Input** button.
- 2 Press the  or  button to select a source.
- 3 Press the **Enter** button to confirm the selection / switch to the selected input source.

Note:

- ◆ After pressing the **Input** button or swiping up from the bottom edge of the screen, the General Setting OSD menu will be displayed on the screen.

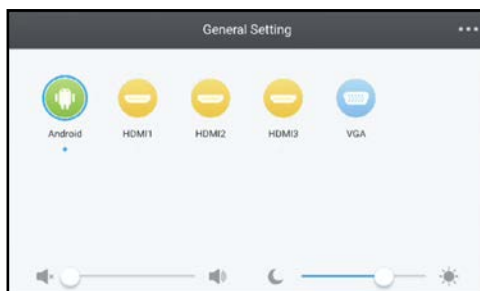

Note:

- ◆ If the selected input source signal is not connected to the interactive display or is turned off, the screen will display “**No signal**” message.



- ◆ All available sources are indicated by  below them.
- ◆ The selected source has a blue circle around the source icon.

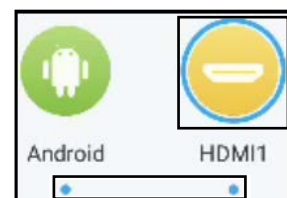

USING THE INTERACTIVE DISPLAY

3.3 Adjusting the Volume

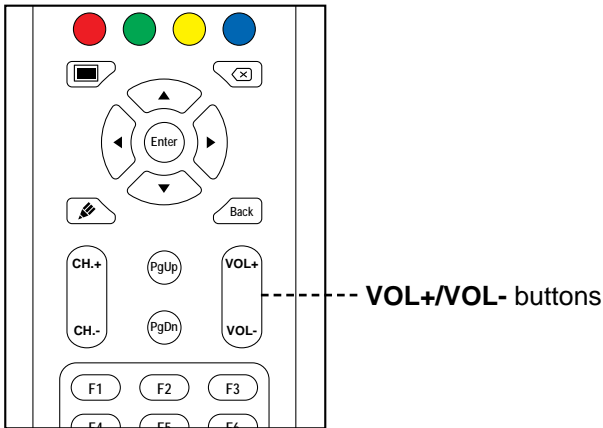

Press the **VOL-** or **VOL+** button to adjust the volume level.

3.4 Using Freeze Function

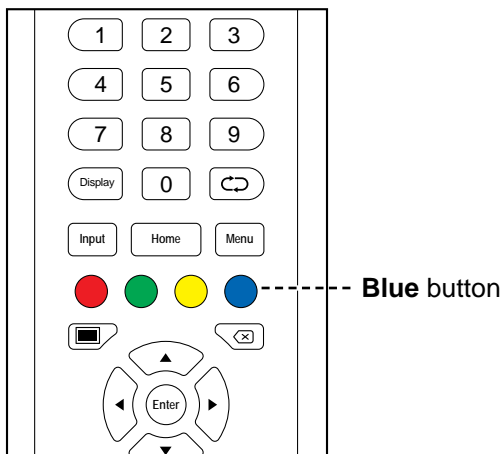

Press the **Blue** button to freeze the screen image but still continue real-time playback until the image is unfreeze. The freeze control bar () and the icon appear on the screen.

While the screen freeze is activated, you can perform the following operations:

- : Zoom in on the image.
- : Zoom out on the image.
- : Display the screen image in its original ratio.
- : Close the freeze control bar and unfreeze.

The screen image displays the elapsed real-time playback image when screen freeze is deactivated.

Note:

- ◆ After pressing the **VOL-** or **VOL+** button, the volume menu is displayed on the screen automatically.



- ◆ Press the button to mute the audio. When muted, the icon appears on the screen.

Note:

- ◆ You can unfreeze the screen also by pressing the **Blue** button again.

USING THE INTERACTIVE DISPLAY

3.5 Android Functions

3.5.1 Accessing the Home Screen

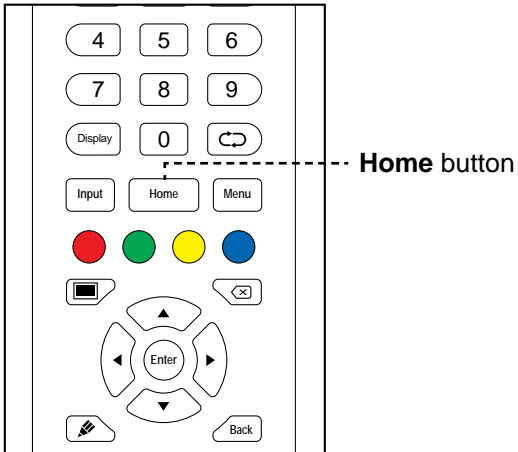

Press the **Home** button to access the Home screen of the system.

3.5.2 Returning to the Previous Screen

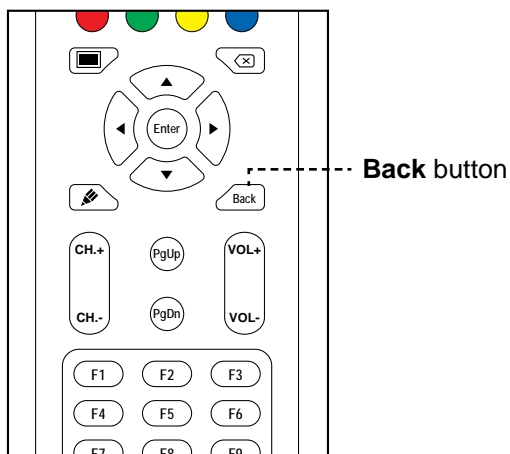



Press the **Back** button to return to the previous screen.

USING THE INTERACTIVE DISPLAY

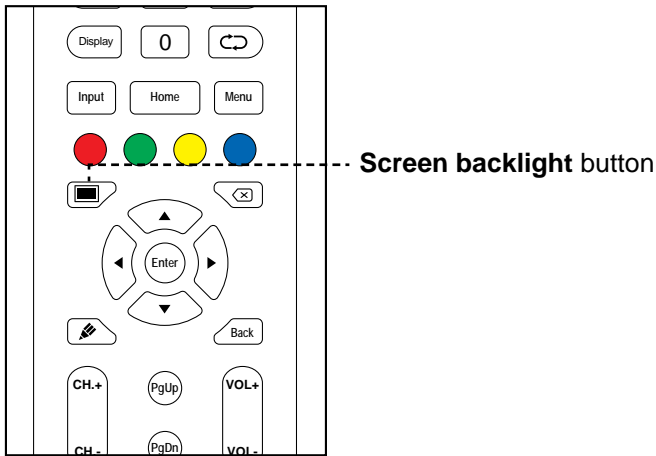
3.5.3 Blanking the Screen



Press the  button to blank the screen. The screen turns black. Press the  button again to turn on the screen backlight.

3.5.4 Activating the Writing Mode

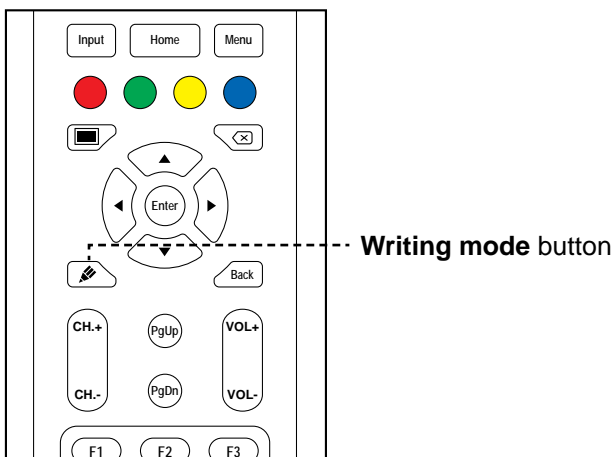



Press the  button to open the **Meetboard** app and start writing on the screen.

USING THE INTERACTIVE DISPLAY

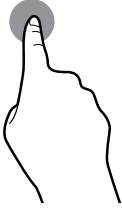
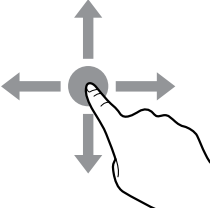

3.6 Using the Touchscreen

In addition to the remote control, you can also operate your interactive display using the touch gestures as described in the tables below.

For Android

Action	Touch Gesture	Function
Touch		<p>Touch to open clickable items on the screen, such as apps, Assistive menu options, and more.</p> <p>Note:</p> <ul style="list-style-type: none"> ◆ Always touch the screen with your finger or with the supplied touch pen. ◆ Do not touch the screen with sharp, metallic objects that could scratch the screen's coating.
Touch and hold		<ul style="list-style-type: none"> • Review and control the app <ol style="list-style-type: none"> a) On the Apps screen, touch and hold the app icon that you want to review. b) Drag the app onto the App info at the top of the screen and then release. The app's information screen opens.
Drag or swipe		<div style="text-align: center;">   </div> <ul style="list-style-type: none"> • Touch and hold on either of the Assistive menu icons ○, then drag it up or down based on your preference. • In Detail Setting menu, drag the ● (adjustment circle) clockwise or counterclockwise in an arc trajectory to adjust the item value.

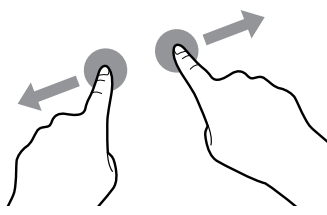
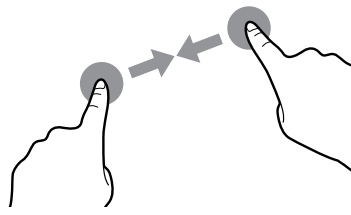
USING THE INTERACTIVE DISPLAY

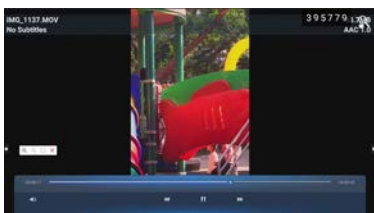
Action	Touch Gesture	Function
Zoom	<p>Zoom in</p>  <p>Zoom out</p> 	<ul style="list-style-type: none"> When the freeze function is activated, zoom in or zoom out on the image. <p>For example:</p> <p>Zoom in</p>  <p>Zoom out</p> 

For Windows

Note:

- ◆ Make sure you have connected properly the Windows-based device to the interactive display.
- ◆ Multi-touch functions are only supported on Windows 10, Windows 8, Windows 7 Home Premium / Professional / Enterprise / Ultimate operating systems and not supported on Windows XP, Windows Vista, and Windows 7 Starter / Home Basic.
- ◆ Windows is a registered trademark of Microsoft Corporation in the United States and other countries.

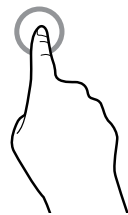
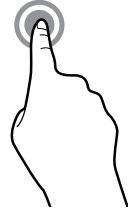
Function	Touch Gesture	Action
Single-touch gestures:		
Note:		
◆ For Windows XP, Windows Vista, Windows 7, Windows 8, and Windows 10		
Tap		Touch the screen once.
Double-tap		Touch the screen twice.

USING THE INTERACTIVE DISPLAY

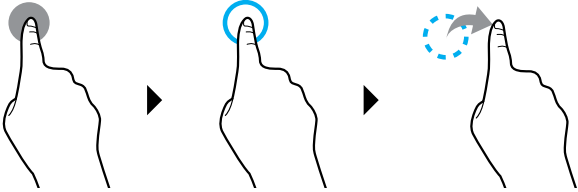
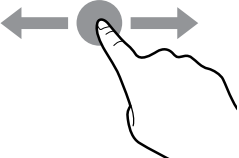
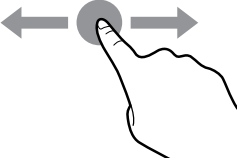
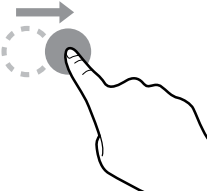
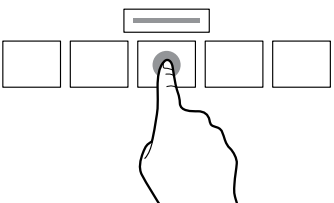
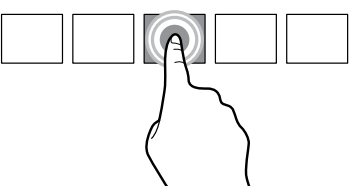
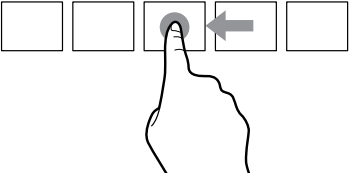
Function	Touch Gesture	Action
Right-tap		Touch and hold on the target until a blue ring appears. Then release your finger.
Drag		Touch the screen and drag with one finger to the left or to the right.
Note:		
◆ For Windows Vista, Windows 7, Windows 8, and Windows 10		
Selection		Touch the screen and drag with one finger to the left or to the right.
Pan up / Pan down / Back / Forward		Touch the screen and quickly drag your finger to the desired direction.
Note:		
◆ For Windows 8		
Learn		Touch and hold the screen to display more information. Anything displayed this way should not prevent you panning.
Primary action		Touch the target to invoke its primary action. For example, launch an app or execute a command.
Pan		Touch the screen and slide for panning interactions, moving items, drawing, or for writing. Slide can also be used to target small, densely packed elements by scrubbing (sliding the finger over related objects, such as radio buttons).

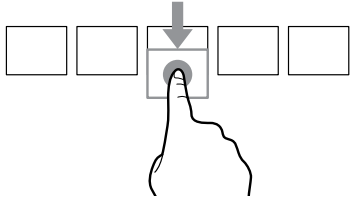
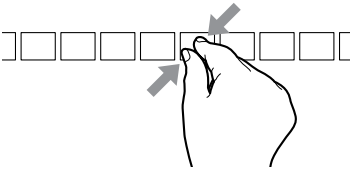
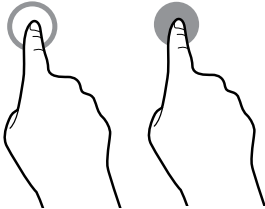
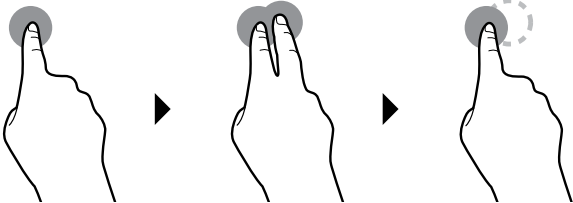
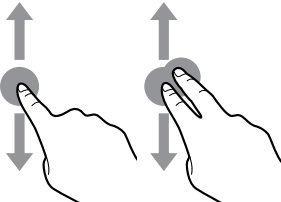

USING THE INTERACTIVE DISPLAY

Function	Touch Gesture	Action
Select, command, and move		Touch the screen and swipe to select, command, and move. Sliding your finger a short distance, perpendicular to the panning direction, selects objects in a list or grid and displays the app bar with related commands when objects are selected.
Zoom		Touch the screen and pinch or stretch to zoom out or zoom in respectively. The pinch and stretch gestures are more commonly used for resizing but also enable to move to the beginning, end, or anywhere within content with semantic zoom.
Note:		
♦ For Windows XP, Windows Vista, and Windows 7		
Wake the computer up from the sleep mode (S3)		Touch and hold the screen for around 4 seconds.
Multi-touch gestures:		
Note:		
♦ For Windows 7 Home Premium / Professional / Enterprise / Ultimate version		
Right-tap		Touch and hold on the target and quickly touch the screen once with another finger.
Scrolling		Touch and drag the screen with one or two fingers up or down.

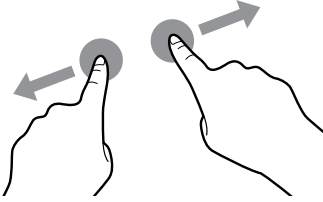
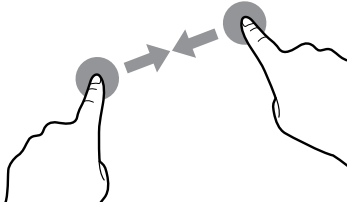
USING THE INTERACTIVE DISPLAY

Function	Touch Gesture	Action
Zoom	<p>Zoom in</p>  <p>Zoom out</p> 	Touch the target and move your two fingers apart or toward each other to zoom in or zoom out respectively.

3.7 Using the On-Screen Keyboard

Whenever you need to input text, an on-screen keyboard opens automatically. Touch the keys on the screen as you would press the keys on a connected keyboard. You can also relocate the on-screen keyboard by holding and dragging the keyboard by the  icon to the desired location on the screen. To close the on-screen keyboard, press .

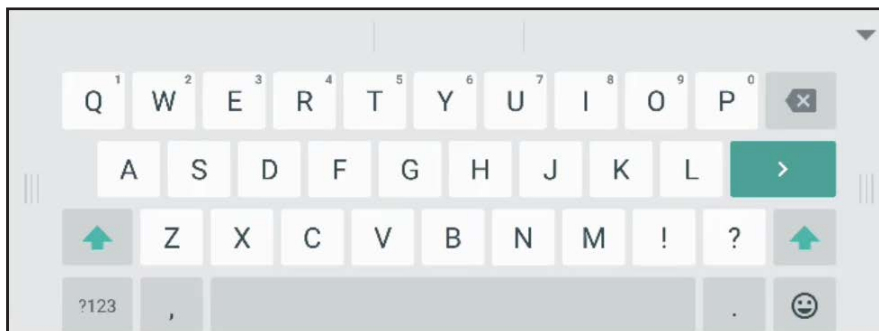

CHAPTER 4: USING THE SYSTEM

4.1 About the Home Screen

After you power on the system, you will see the Home screen. On the Home screen, you can view the current date and time, access the Assistive menu and various apps, check system status, and remote code.



#	Item	Description
1	Assistive menu	Quick access for switching the input source, moving backwards, accessing the Home screen, managing recently used apps, opening various apps, and enabling annotation function. Refer to pages 42-43. Note: ◆ The Assistive menu icons are visible on both sides of the interactive display.
2	Date and Time	Displays the current date and time. Adjust the settings in Settings menu. Refer to pages 51-52.
3	Remote Code	Enables remote connections to the interactive display. Refer to pages 49-51.
4	Status Bar Indicators	Displays the connections.
5	App Shortcuts	Accesses the Finder app, Meetboard app, Apps screen, and ScreenShare Pro app.

Note:

- ◆ In Android mode, if no touch activity is detected within 15 minutes, the device will prompt to shut down for energy saving purposes. Refer to page 53. If no action is taken, the device will shut down automatically after 10 seconds.

4.2 Using the Assistive Menu

The Assistive menu can be accessed on either side of the interactive display. For more convenient access, you can touch and hold on the Assistive menu icon to slide it up or down. Assistive menu icons are always visible on the screen regardless of your location in the user interface.

To use the Assistive menu, do the following:

- 1 Touch the icon on either side of the interactive display.
The Assistive menu opens.
- 2 Touch any of the following Assistive menu items:
 - **Source** : Selects an input source among Android, HDMI1, HDMI2, HDMI3, and VGA.



USING THE SYSTEM

- **Back** ↶: Returns to the previous screen.

Note:

- ◆ Back function is available only if the source is Android.

- **Home** 🏠: Accesses the Home screen.

- **Recently Used Apps** 📄: Manages recently used apps. Do any of the following:

- To reopen: Touch the app.

- To close: Swipe the app to the left or to the right.

- To close all apps: Touch 🗑️ **Clean All Processes (#)** where “#” is the number of opened apps.

Note:

- ◆ Recently used apps function is available only if the source is Android.

- **More Tools** ☰: Touch 📏 to open **SpotLight** for emphasising an area on the screen, touch 📷 to open the **ScreenShot** capture tool and to capture a screenshot, or touch ⌚ to open **CountDown** timer to count down time for events.

- **Annotation App** ✎: Opens the **Annotation** app and enters writing mode.

Note:

- ◆ The **Annotation** app cannot be accessed while using the **Meetboard** app.

- 3 To close the Assistive menu touch ⏪ or touch anywhere on the screen.

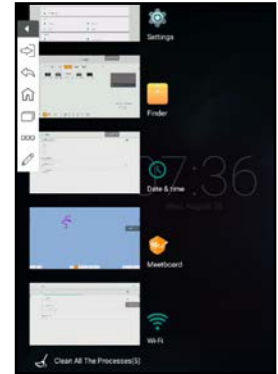

4.3 Using the Meetboard App

Meetboard is an interactive app that enables you to make drawings for demonstrating ideas on the display. The drawings can be saved to the device memory, connected portable disk, or cloud storage, or easily shared via QR code or email.

To use the **Meetboard** app, do the following:

- 1 Touch the 📄 icon on the Home screen or the 🗂️ icon on the Apps screen. The **Meetboard** app opens.





- 2 Draw directly on the board with the default settings for colour, marker width, pen type (pencil, marker, and brush), and background colour or touch any of the following icons to modify the default settings:

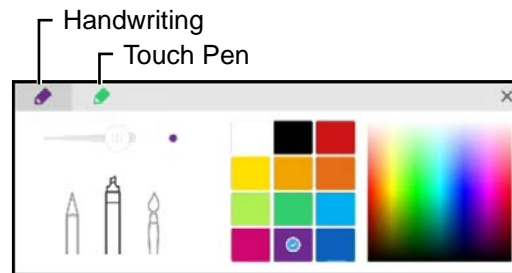

USING THE SYSTEM

- : Sets up the colour and width for the pen while handwriting or while using the touch pen.



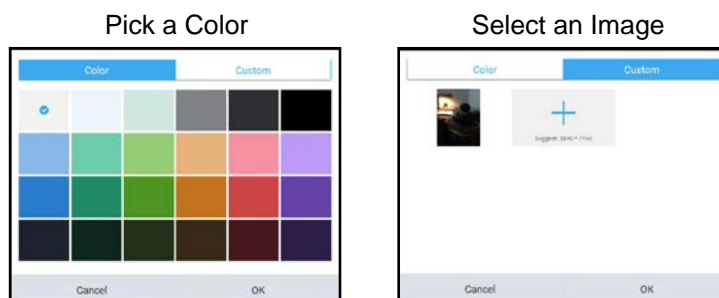

- Touch  >  **Background**: Sets up the colour of the background. To set an image on the background, touch **Custom** and select a background image from the internal memory or from a portable disk. When the background is modified, touch **OK** to confirm. Touch **Cancel** if you want to keep the current writing board background.



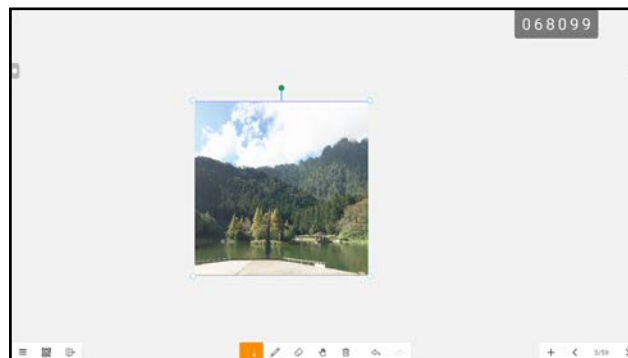

- Touch  >  **Import**: Imports an image or PDF file on the writing board from the internal memory or a portable disk. After importing the image, you can drag the image around the screen, use your hands or control circles around the image to zoom-in, zoom-out, and rotate as needed.







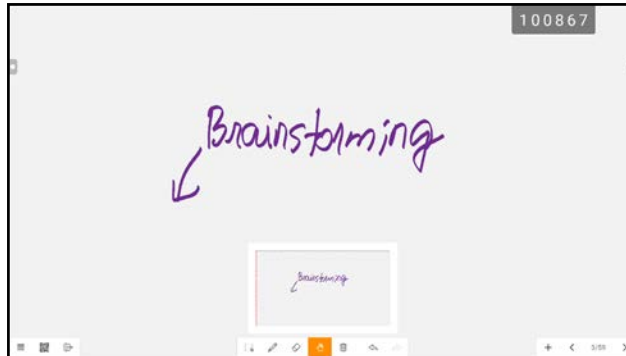

3 To control the drawing on the board, use the following actions:

- : Selects part of the image that you can drag around the screen. You can change the selected image colour, use your hands or control circles around the fraction of the image to zoom-in, zoom-out, and rotate as needed.
- **Erase**: Put your fist or palm on the board and move to the area that needs to be erased or touch  to switch to erase mode and then touch the area on the screen that needs to be erased.

USING THE SYSTEM

- : Switches to the roaming mode. Operate the writing board with one point to drag the content of the board around the screen or with two points to zoom in or zoom out on the content of the screen. To review the current position of the content on the screen, touch  again.









- : Clears the entire board.
- : Reverses the most recent action on the writing board.
- : Restores the most recent action on the writing board.
- : Adds a new page.
- : Moves to the previous page if there are multiple pages in the file.
- : Moves to the next page if there are multiple pages in the file.

Note:

- ◆ Touch on the page count (3/59) to thumbnail all pages and remove unnecessary pages.

4 After the drawing is finalised, touch any of the following:

-   **Save**: Select a storage and path where to save the drawing and then name the drawing.
-   **Export**: Export the drawing as an image file or PDF file. You are prompted to select the storage, path, and name for the drawing.
-   **Cloud Storage**: Save the drawing to your cloud storage. You are prompted to select a drive (**Google Drive** or **OneDrive**). If you are logging in to your cloud storage for the first time, you are prompted to enter your credentials. Follow the on-screen instructions to configure the access to your cloud storage.

In addition, you can select to always use your default cloud storage account and always save the file with the default name.

Note:

- ◆ To save to the cloud storage, make sure the interactive display is connected to the Internet.

USING THE SYSTEM

- ☰ > ✉ **Send Email**: Emails the drawing. If you are sending the drawing by email for the first time, you are prompted to configure your email settings. Follow the on-screen instructions to complete the configuration.

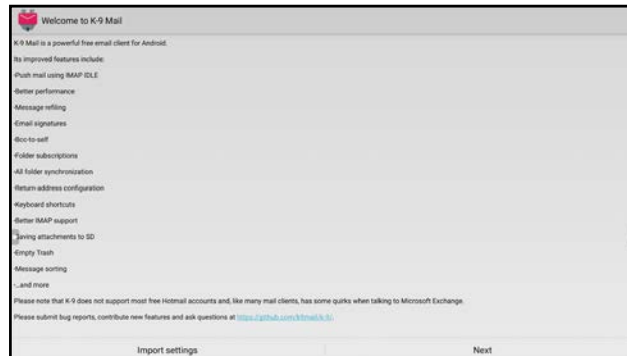

After the settings are configured, return to the **Meetboard** app and send the drawing by email. The drawing is added as an attachment.



Note:

- ◆ To send an email, make sure the interactive display is connected to the Internet.
- 📄: Displays a QR code on the screen that directs to the online location where the drawing can be downloaded to any portable device that is connected to the same Wi-Fi with the interactive display.



Note:

- ◆ The interactive display can be accessed by scanning the QR code from other devices only if the display and all the other devices are connected to the same domain or wireless access point.
- ◆ Touch the QR code again to make it larger on the screen if needed.
- ☰ > 📄 **Open**: Opens previously saved file from the storage device. You are prompted to select a storage device and the path where the file is saved.
- ☰ > 📄 **New**: Opens a new writing board.
- 🏠: Exits the **Meetboard** app. You are prompted to confirm saving modifications and exit the **Meetboard**.

USING THE SYSTEM

4.4 Using the Annotation App

Annotation is an app that provides a more fluid discussion of visual images by annotating anywhere on the display.

Note:





- ◆ The **Annotation** app cannot be accessed while using the **Meetboard** app.

To use **Annotation** app, do the following:

- 1 In Assistive menu, touch .

The system enters to the writing mode and displays the **Annotation** control bar on the screen.



- 2 Draw directly on the screen with the default settings for colour and pen type. To change the default pen colour, touch  or  repeatedly until you find the desired pen colour.
- 3 After the drawing is finalised, touch any of the following:
 - : Erases the drawing. To erase part of the drawing, use your fist or palm.
 - : Save the drawing. The drawing is automatically saved to the device memory.
- 4 To exit the **Annotation** app, touch .



4.5 Using the Finder app

Finder enables you to manage files that are saved in the internal memory or in any accessible external storages.













On the **Finder** Home screen, you can access the content of the storage devices (internal memory or portable devices), access the file categories, perform search, review file or folder details, content of the storage, its folder and files, and perform operations with files and folders using the control bar.



To start using the **Finder** app, do the following:

- 1 On the Home screen, touch  or on the Apps screen, touch .
- 2 Touch any of the following:
 - : Sorts the content by name, type, size, or time.

USING THE SYSTEM

- : Displays content side by side.
 - : Displays content in a list.
 - : Selects individual items or all visible items for copy () , paste () , cut () , deletion () , rename () (only available for individual item) , or for sending to another storage device (). Touch  to select all items or touch  to exit the selection mode.
 - : Adds a folder.
- 3 Touch  to exit the **Finder** app.

4.6 Accessing Apps

Some apps, such as **Meetboard**, **Finder**, and **ScreenShare Pro**, are accessible directly from the Home screen. Other apps that are installed to the system can be accessed through the Apps screen.

To access the Apps screen, do the following:

- 1 On the Home screen, touch .

The Apps screen opens.





- 2 On the Apps screen, touch any of the following apps:

- **Browser** /**Chromium** : Opens the web browser for surfing the Internet.

Note:

◆ Make sure your interactive display is connected to the Internet.

- **Calculator** : Opens the on-screen calculator and then you can perform basic mathematical calculations.

- **Cloud Drive** : Configures cloud drive access settings. These settings may be prompted also in other apps that require cloud connection.

- **Finder** : Manages your files. Refer to page 47.

- **K-9 Mail** : Configures email settings. These settings may be prompted also in other apps that require sending files by email.

USING THE SYSTEM

- **Keeper** : Optimises system performance easily.

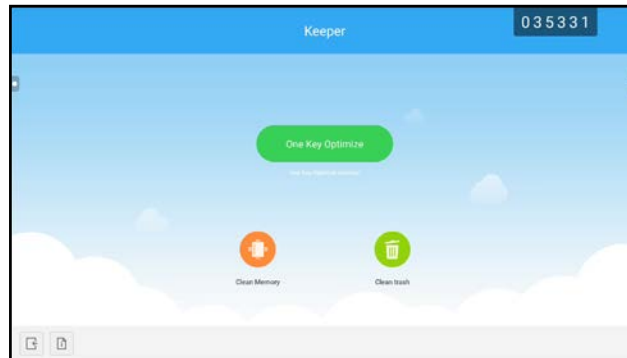



- **Meetboard** : Opens a whiteboard application for brainstorming and more. Refer to pages 43-46.

- **Screenlock** : Sets a password to protect against undesired screen access.

Note:

- ◆ If you forgot the lock screen password, press “Input” + “0” + “2” + “1” + “4” buttons on the remote control.

- **ScreenShare Pro** : Mirrors the screen of your portable device to the interactive display and more.

- **Settings** : Views and configures system settings. Refer to pages 51-52.

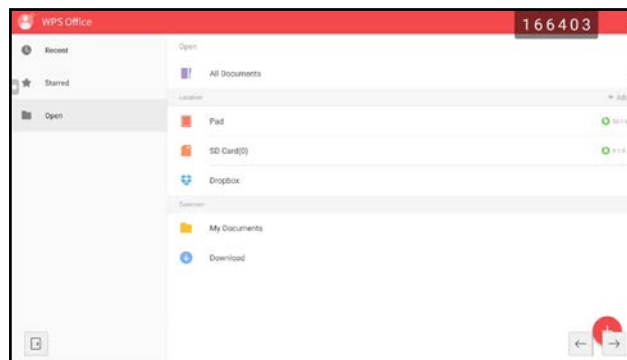

- **WPS Office** : Views PDF files, opens and edits different files including Microsoft Word, PowerPoint, Excel, and text files. You can also create new spreadsheets, presentations, memos, and documents.



4.7 Using the ScreenShare Pro App

With the **ScreenShare Pro** app, you can mirror the display’s screen on your portable device for hands-on annotation, mirror the screen of your device on the display, or use your device as a remote control for the display.

To start using the **ScreenShare Pro** app, do the following:

- 1 Make sure your portable device and the interactive display are connected to the same wireless network.
- 2 On the Home screen, touch  or on the Apps screen, touch .

The **ScreenShare Pro** Home screen opens.

USING THE SYSTEM

- 3 On the Home screen, touch **User Guide** ().
- 4 Scan the QR code to access the **ScreenShare Pro** sender download page and then install the sender to your portable device.
- 5 Connect your portable device and the interactive display to the same wireless access point.
- 6 Open the **ScreenShare Pro** app on your portable device and enter the remote code that is visible on the interactive display screen.



After the connection is established, the following screen opens on your portable device:

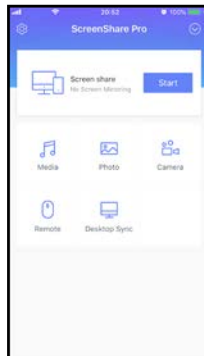

- 7 Touch any of the following:
 - **Media:** Plays media files from your portable device on the interactive display.
 - **Photo:** Displays photos from your portable device on the interactive display.
 - **Camera:** Mirrors your camera screen on the interactive display.
 - **Remote:** Enables you to use your portable display as a remote mouse for operating the interactive display.
 - **Desktop Sync:** Mirrors the fully functional interactive display screen on your portable device.
 - **Screen share:** Mirrors your portable device's screen on the interactive display.
 - In iOS, swipe the screen up to open **Control Center > Screen Mirroring** and select **ScreenShare Pro**. To stop mirroring, touch **Stop Mirroring**.

USING THE SYSTEM

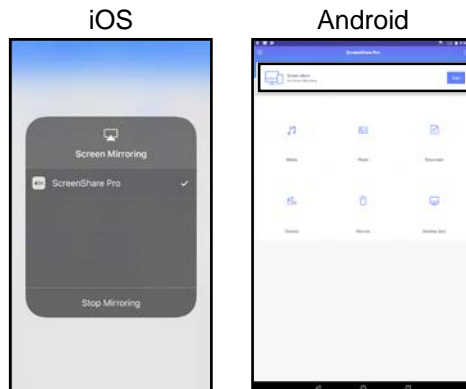

- In Android, touch **Start** in **Screen share** panel to start mirroring the screen. To stop mirroring, touch .



4.8 Configuring System Settings

In Settings menu, you can configure various system settings.

To access the Settings menu, do the following:

- 1 On the Home screen, touch  > .

The Settings menu opens.

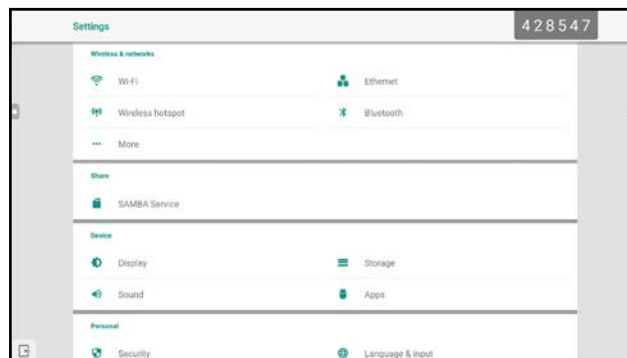

- 2 Configure any of the following settings:

Wireless and networks:

- **Wi-Fi:** Connects to an available wireless access point. Enter the access password if prompted.
- **Ethernet:** Connects to LAN through a wired connection. Depending on the web server configuration, you may need to configure the network settings manually or automatically (DHCP).
- **Wireless hotspot:** Shares interactive display's Internet connection to other devices through hotspot.
- **Bluetooth:** Connects to other Bluetooth devices.
- **More > VPN:** Sets up and manages virtual private networks for safe and secure online communication.

Share:

- **SAMBA Service:** Configures SAMBA settings for sharing file and print services.

USING THE SYSTEM

Device:

- **Display:** Configures external source display settings (HDMI output) and sets pixel shift to prevent “burn-in” effect.
- **Storage:** Manages both internal and external storages.
- **Sound:** Manages touch sound and sound output settings.
- **Apps:** Manages apps that are installed to the interactive display.

Personal:

- **Security:** Manages credentials.
- **Language & input:** Sets system language and configures keyboard and input settings.
- **Power Setting:** Configures startup, shutdown settings, and sets schedule for closing power off reminder.
- **Password:** Sets or changes the screen lock password. If you forgot the screen lock password, refer to page 49.
- **Input Setting:** Renames input sources.
- **Other Settings:** Configures various settings: floating annotation, system dock channel, and note writing.

System:

- **Date & Time:** Configures date and time related settings.
- **About device:** Displays device information.
- **System Update:** Upgrades the system.

- 3 To exit the Settings menu, touch .

USING THE SYSTEM

4.9 System Power Options

In Power Setting menu, you can disable sleep mode or configure how the interactive display enters and wakes up from the sleep mode.

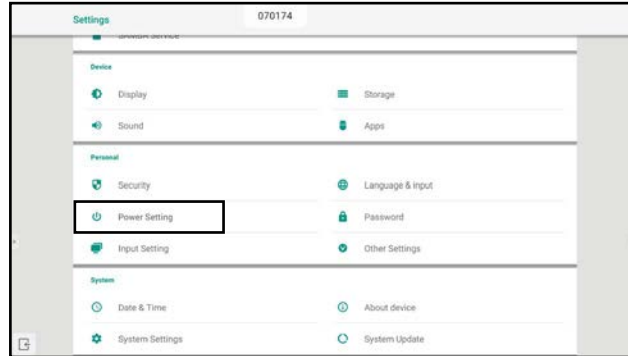

4.9.1 Wake On Source Option

To enable the interactive display to wake up from the sleep mode when an HDMI or VGA source is detected, check **Enabled (HDMI/VGA inputs can wake up the system)** in > > Personal > Power Setting > System power options > Wake on source menu.

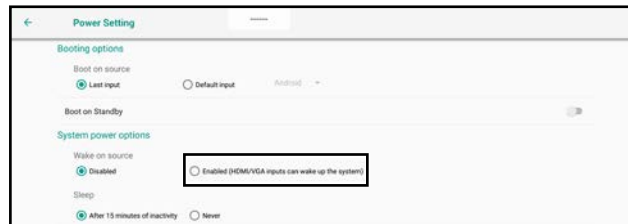

4.9.2 Sleep Mode

- To keep the interactive display from entering sleep mode, check **Never** in > > Personal > Power Setting > System power options > Sleep menu.



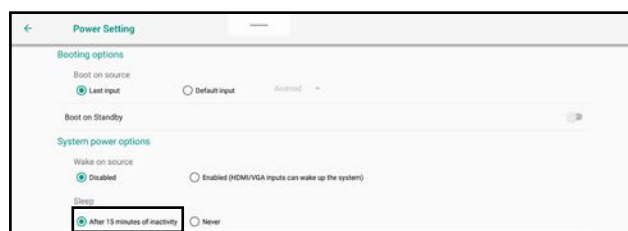

- To enable the interactive display to enter sleep mode after 15 minutes of inactivity, check **After 15 minutes of inactivity** in > > Personal > Power Setting > System power options > Sleep menu.



CHAPTER 5: ON SCREEN DISPLAY MENU

5.1 Using the OSD Menu

#	Menu Navigation	Operation	
		Remote Control	Touch Gesture
1	<p>Display the Detail Setting menu.</p> 	<p>Press the Menu button.</p>	<p>Touch the Assistive menu $\bigcirc > \text{Assistive} > \dots$ or swipe the screen from the bottom to up and then touch \dots.</p>
2	<p>Enter the submenu.</p> 	<ol style="list-style-type: none"> 1 Press the \blacktriangleleft or \blacktriangleright button to select the main menu item. 2 Press the \blacktriangledown button to enter the submenu. 3 Press the \blacktriangleleft, \blacktriangleright, \blacktriangleup, or \blacktriangledown button to select the submenu item. 4 Press the Enter button to enter the adjustment mode. 	<ol style="list-style-type: none"> 1 Touch the main menu item. 2 Touch the submenu item to select it.
3	<p>Adjust the settings.</p> <p>For example:</p> 	<p>Press the Enter button to change the setting or press the \blacktriangleleft or \blacktriangleright button to adjust the value.</p>	<p>Touch the setting or drag the \bullet clockwise or counterclockwise in an arc trajectory to adjust the item value.</p>
4	<p>Close the OSD window.</p>	<p>Wait until the OSD menu disappears automatically (around 10 seconds) or press the Back button (repeatedly if necessary).</p>	<p>Touch anywhere on the screen.</p>

When settings are modified, all changes are saved when the user does the following:

- Proceeds to the another menu.
- Exits the OSD menu.
- Waits for the OSD menu to disappear.

ON SCREEN DISPLAY MENU

Note:

- ◆ Availability of some menu items depend on the input source signal or selected setting. If the menu is not available, it is disabled and grayed out.

5.2 OSD Menu Tree

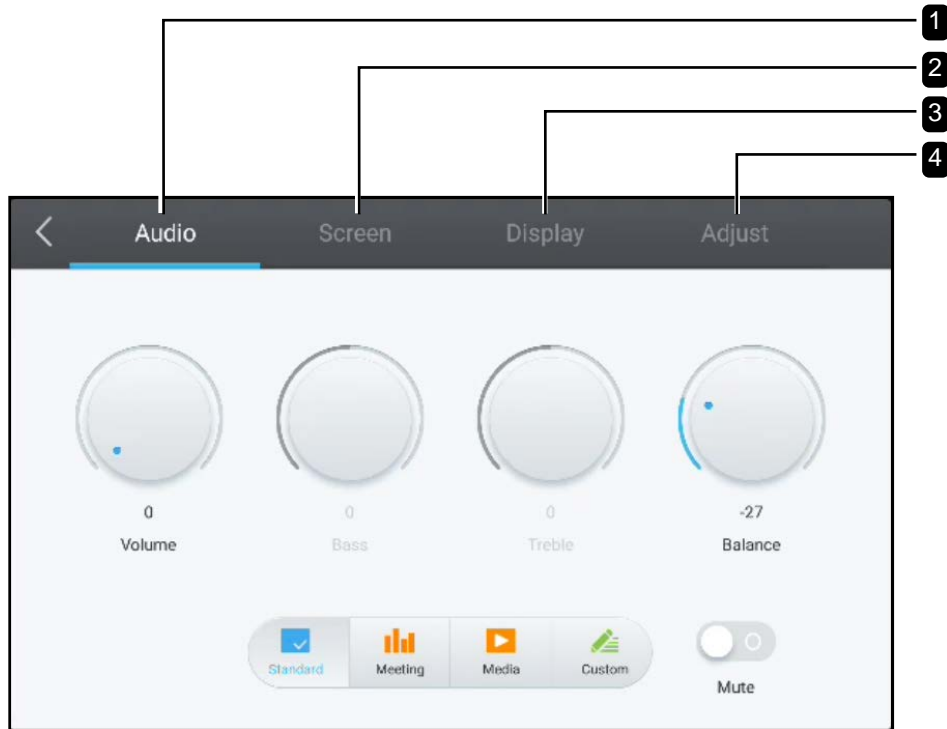

Main Menu	Submenu	Remarks
1. Audio	<ul style="list-style-type: none"> • Volume • Bass • Treble • Balance • Mute 	See page 56.
2. Screen Note: This menu is not supported if the input source is Android.	<ul style="list-style-type: none"> • 4:3 • 16:9 • Full • ANTI-BURN-IN 	See page 57.
3. Display Note: This menu is not supported if the input source is Android.	<ul style="list-style-type: none"> • Brightness • Contrast • Hue • Sharpness 	See pages 57-58.
4. Adjust Note: This menu is only supported if the input source is VGA.	<ul style="list-style-type: none"> • H Position • V Position • Clock • Phase • AUTO 	See pages 58-59.

CHAPTER 6: ADJUSTING THE INTERACTIVE DISPLAY

6.1 Audio Menu



- 1 Press the **Menu** button.
The Detail Setting menu opens automatically.
- 2 Press the ◀ or ▶ button to select **Audio** menu.
- 3 Press the ▼ button to enter submenu.
- 4 Press the ◀, ▶, ▲, or ▼ button to select the submenu item.

Item	Function	Operation	Range
Predefined Audio Modes	Selects the predefined audio mode.	Press the Enter button to select the setting.	Standard Meeting Media Custom
Volume	Adjusts the volume.	<ol style="list-style-type: none"> 1 Press the Enter button to select the setting. 2 Press the ◀ or ▶ button to adjust the value. 	0 to 100
Bass	Adjusts to increase or decrease lower-pitched sounds. Note: This item can be adjusted only if the Predefined Audio Mode is set to Custom .		-5 to 5
Treble	Adjusts to increase or decrease higher-pitched sounds. Note: This item can be adjusted only if the Predefined Audio Mode is set to Custom .		-5 to 5
Balance	Adjusts to emphasise the left (L) or right (R) audio output balance.		-50 to 50
Mute	Mutes the volume. Note: If the sound is muted then all the Audio menu items become unavailable except for the Volume .	Press the Enter button.	On Off

ADJUSTING THE INTERACTIVE DISPLAY

6.2 Screen Menu

Note:

- ◆ Screen menu items are not available if the input source is Android.

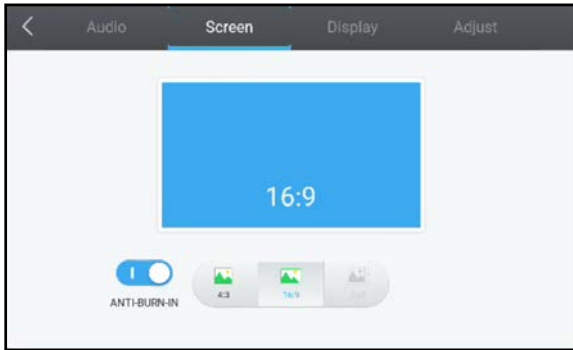

- 1 Press the **Menu** button.
The Detail Setting menu opens automatically.
- 2 Press the ◀ or ▶ button to select **Screen** menu.
- 3 Press the ▼ button to enter submenu.
- 4 Press the ◀ or ▶ button to select the submenu item.

Item	Function	Operation	Range
ANTI-BURN-IN	Prevents image retention	Press the Enter button.	On
			Off
4:3	Sets the aspect ratio to 4:3.		N/A
16:9	Sets the aspect ratio to 16:9.		N/A
Full	Sets the aspect ratio to full screen.		N/A

6.3 Display Menu

Note:

- ◆ Display menu items are not available if the input source is Android.



- 1 Press the **Menu** button.
The Detail Setting menu opens automatically.
- 2 Press the ◀ or ▶ button to select **Display** menu.
- 3 Press the ▼ button to enter submenu.
- 4 Press the ◀ or ▶ button to select the submenu item.

Item	Function	Operation	Range
Predefined Display Modes	Selects the predefined display mode.	Press the Enter button to select the setting.	Standard
			Bright
			Soft
			Custom
Predefined Colour Temperature Modes	Selects the predefined colour temperature mode.		Standard
			Cool
			Warm

ADJUSTING THE INTERACTIVE DISPLAY

Item	Function	Operation	Range
Brightness	Adjusts the luminance of the screen image. Note: This item can be adjusted only if the Predefined Display Mode is set to Custom .	1 Press the Enter button to select the setting. 2 Press the ◀ or ▶ button to adjust the value.	0 to 100
Contrast	Adjusts the difference between the black level and the white level. Note: This item can be adjusted only if the Predefined Display Mode is set to Custom .	1 Press the Enter button to select the setting. 2 Press the ◀ or ▶ button to adjust the value.	0 to 100
Hue	Adjusts the colour balance of red and green. Note: This item cannot be adjusted.	N/A	50
Sharpness	Adjusts the clarity and focus of the screen image. Note: This item cannot be adjusted.		50

6.4 Adjust Menu

Note:

- ◆ Adjust menu items are only available if the input source is VGA.



- 1 Press the **Menu** button.
The Detail Setting menu opens automatically.
- 2 Press the ◀ or ▶ button to select **Adjust** menu.
- 3 Press the ▼ button to enter submenu.
- 4 Press the ▲ or ▼ button to select the submenu item.

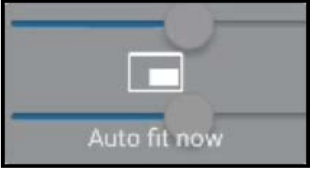
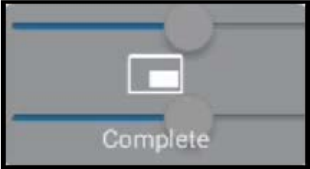

Item	Function	Operation	Range
H Position	Moves the image to the right or to the left.	1 Press the Enter button to enter the adjustment mode. 2 Press the ◀ or ▶ button to adjust the value.	0 to 100
V Position	Moves the image up or down.		0 to 100
Clock	Adjusts the width of the image.		0 to 100
Phase	Adjusts to improve the focus, clarity, and stability of the image.		0 to 100

ADJUSTING THE INTERACTIVE DISPLAY

Item	Function	Operation	Range
AUTO	<p>Adjusts the screen image automatically.</p> <p>Note: During the auto adjustment, you will see the progress notification followed by the procedure is complete notifications.</p> <p>Auto Fit in Progress</p>  <p>Procedure is Complete</p> 	Press the Enter button.	N/A

CHAPTER 7: APPENDIX

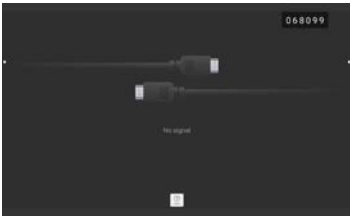
7.1 Warning Messages

Warning Messages	Cause	Solution
	The resolution or the refresh rate of the graphics card of the computer is set too high.	<ul style="list-style-type: none"> Change the resolution or the refresh rate of the graphics card.
	The interactive display cannot detect the input source signal.	<ul style="list-style-type: none"> Check if the input source is turned ON. Check if the signal cable is properly connected. Check if any pin inside the cable connector is twisted or broken.

7.2 Supported Media Formats

Video Format

File Format	Extension	Video Codec	Audio Codec
MP4	.3gp	H.264	AMR
		MPEG4	LPCM(PCM) MP3
	.mp4	MPEG4	MP3 AMR
		H.264	MP3
	.3g2	H.263	AMR
AVI	.avi	MPEG1	MP3
		MPEG2	MP2
		Xvid-ASP	MP3
		H.264	PCM
		MPEG	PCM
Flash Video	.flv	VP6	MP3
		H.264	MP3
		H.263	MP3
	.f4v	H.264	MP3
MKV	.mkv	MPEG4	MP2
PS	.VOB	MPEG-2	PCM MP2
			H.264
	.mpg .mpeg	MPEG-4	MP3
		MPEG2	MP3(MP2) LPCM
		MPEG1	MP2
TS	.ts	MPEG2	MP2
		H.264	MP2

APPENDIX

Music Format

File Format	Extension
Monkey's Audio	.ape
FLAC	.flac
ALAC	.m4a
MPEG1/2 Audio Layer3	.mp3
Vorbis	.ogg
WAV	.wav

Photo Format

File Format	Extension
BMP	.bmp
GIF	.gif
JPEG	.jpeg/.jpg
PNG	.png

Note:

- ◆ Sound or video may not work if the contents have a standard bit rate/frame rate above the compatible Frame/sec listed in the table above.
- ◆ Video content with a Bit rate or Frame rate larger than the rate specified in the table above can cause choppy video during playback.

7.3 Supported Resolution

Computer Mode

Standard Resolution	Resolution		Refresh Rate
	Horizontal	Vertical	
IBM VGA	720	400	70
IBM VGA	640	480	60
VESA	800	600	56
VESA	800	600	60
VESA	1024	768	60
VESA	1280	720	60
VESA	1280	800	60
VESA	1280	960	60
VESA	1280	1024	60
VESA	1680	1050	60
VESA	1920	1080	60
4K2K (HDMI)	3840	2160	60

APPENDIX

Video Mode

Standard Resolution	Resolution		Refresh Rate
	Horizontal	Vertical	
EDTV (16:9)	720	480	60i
EDTV (16:9)	720	480	60
EDTV (4:3)	720	480	60i
EDTV (4:3)	720	480	60
EDTV	720	576	50i
EDTV	720	576	50
HDTV	1280	720	50
EDTV	1280	720	60
HDTV	1920	1080	50i
HDTV	1920	1080	50
HDTV	1920	1080	60i
HDTV	1920	1080	60
4K2K (HDMI)	3840	2160	60

General guidelines:



- The PC text quality is optimum in HD 1080 mode (1920 x 1080, 60 Hz).
- Your PC display screen might appear different depending on the manufacturer (and your particular version of Windows).
- Check your PC instruction book for information about connecting your PC to a display.
- When horizontal synchronous signals seem irregular in RGB mode, check PC power saving mode or cable connections.
- The display settings table complies to the IBM/VESA standards, and based on the analog input.
- The best timing for the vertical frequency to each mode is 60 Hz.

APPENDIX

7.4 Troubleshooting

Symptom	Possible Cause	Remedy
No picture is displayed	<ul style="list-style-type: none"> The power cord has been disconnected. The main power switch on the side of the display is not switched on. The selected input has no connection. The display is in standby mode. 	<ol style="list-style-type: none"> 1 Plug in the power cord. 2 Make sure the power switch is switched on. 3 Connect a signal connection to the display.
Interference displayed on the display or audible noise is heard	Caused by surrounding electrical appliances or fluorescent lights.	Move the display to another location to see if the interference is reduced or connect the display to another power outlet.
Colour is abnormal	The signal cable is not connected properly.	Make sure that the signal cable is attached firmly to the back of the display.
Picture is distorted with abnormal patterns	<ul style="list-style-type: none"> The signal cable is not connected properly. The input signal is beyond the capabilities of the display. 	<ul style="list-style-type: none"> Make sure that the signal cable is attached firmly. Check the video signal source to see if it is beyond the range of the display. Please verify its specifications with this display's specification section.
Display image doesn't fill up the full size of the screen	The picture format is not set correctly.	Open the OSD menu > Screen and try the different formats. Refer to page 57.
Can hear sound, but no picture	Improperly connected source signal cable.	Make sure that both video inputs and sound inputs are correctly connected.
Can see picture but no sound is heard	<ul style="list-style-type: none"> Improperly connected source signal cable. Volume is turned all the way down. Mute function is turned on. No external speaker connected. 	<ul style="list-style-type: none"> Make sure that both video and sound inputs are correctly connected. Press the VOL+ button to hear the sound. Switch the mute function off by pressing the  button on the remote control. Connect the external speakers and adjust the volume to a suitable level.
Some picture elements do not light up	Some pixels of the display may not turn on.	This display is manufactured using an extremely high level of precision technology: however, sometimes some pixels of the display may not display. This is not a malfunction.
After-Images can still be seen on the display after the display is powered off. (Examples of still pictures include logos, video games, computer images, and images displayed in 4:3 normal mode)	A still picture is displayed for an over extended period of time.	Do not allow a still image to be displayed for an extended period of time as this can cause a permanent after-image to remain on the display.

APPENDIX

Symptom	Possible Cause	Remedy
The response of the system is slow or the system crashes	<ul style="list-style-type: none"> • Too many apps are running in the background. • The normal operation of the system is disturbed by the environmental conditions, for example thunderstorm. 	Disconnect your interactive display from the power outlet and wait for 1-2 minutes. Then reconnect the power cable and restart the display.
The touch response is slow and not functioning	Too many apps are running in the background.	<ul style="list-style-type: none"> • Close the apps that you are not using. Then touch  > Keeper  to clear cache. • Restart the system.
Cannot connect to Wi-Fi	Wi-Fi module is not installed to the interactive display or is not installed correctly.	(Re)install the Wi-Fi module to the interactive display. Refer to pages 14-15.

7.5 Transporting the Interactive Display

To transport the interactive display for repair or shipment, place the display in its original packaging carton.

- 1 Place the interactive display inside the supplied protective bag.
- 2 Place the lower foam cushion (a) into the lower box (c).
- 3 Place the interactive display inside the lower foam cushion (a).
- 4 Place the wall mount (b) inside the lower foam cushion (a).
- 5 Place the upper foam cushion (e) on top of the interactive display.
- 6 Place the accessories (d) on the designated area inside the upper foam cushion (e) (for IFP-6502) or lower foam cushion (a) (for IFP-7502 and IFP-8602) (if necessary).
- 7 Place the upper box (f) on the interactive display.
- 8 Secure the upper box to the lower box.

APPENDIX

IFP-6502

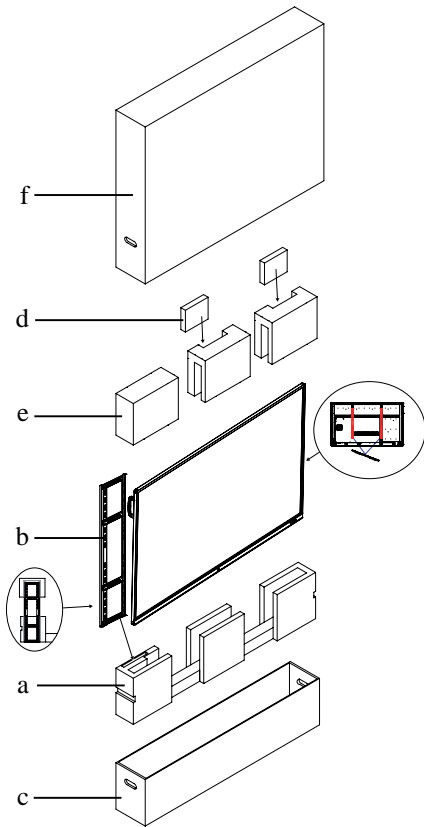

IFP-7502

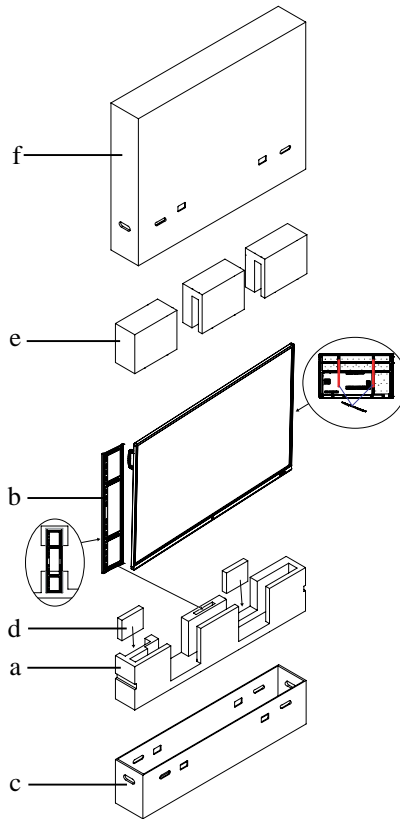

IFP-8602

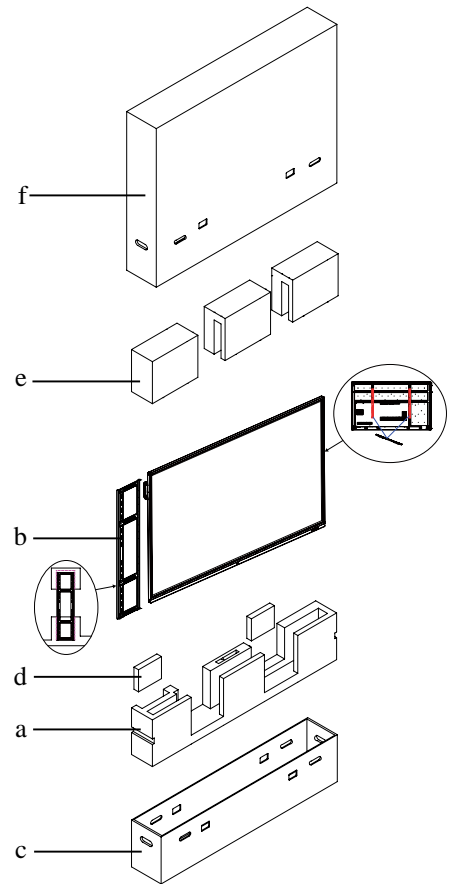

CHAPTER 8: SPECIFICATIONS

8.1 Display Specifications

		IFP-6502	IFP-7502	IFP-8602
Panel	Panel Type	LED-Backlit TFT LCD (IPS Technology)	LED-Backlit TFT LCD (IPS Technology)	LED-Backlit TFT LCD (IPS Technology)
	Panel Size	64.5"	74.5"	85.6"
	Max. Resolution	UHD 3840 x 2160	UHD 3840 x 2160	UHD 3840 x 2160
	Pixel Pitch	0.372 mm	0.430 mm	0.494 mm
	Brightness	350 cd/m ²	350 cd/m ²	350 cd/m ²
	Contrast Ratio	1200:1	1100:1	1200:1
	Viewing Angle (H/V)	178°/178°	178°/178°	178°/178°
	Display Colour	1.07B	1.07B	1.07B
	Response Time	5 ms	5 ms	5 ms
	Surface Treatment	Anti-Glare Treatment (Haze 25%), 3H Hard Coating	Anti-Glare Treatment (Haze 28%), 2H Hard Coating	Anti-Glare treatment (Haze 28%), 2H Hard coating
Frequency (H/V)	H Freq.	30 kHz-80 kHz	30 kHz-80 kHz	30 kHz-80 kHz
	V Freq.	50 Hz-76 Hz	50 Hz-76 Hz	50 Hz-76 Hz
Input	HDMI	2.0 x 3	2.0 x 3	2.0 x 3
	VGA	15-Pin D-Sub x 1	15-Pin D-Sub x 1	15-Pin D-Sub x 1
Output	HDMI	2.0 x 1	2.0 x 1	2.0 x 1
External Control	RS232 In	9-Pin D-Sub	9-Pin D-Sub	9-Pin D-Sub
	LAN (R4 5)	Yes	Yes	Yes
Embedded System	OS	Android 8.0	Android 8.0	Android 8.0
	CPU	Dual core A73+Dual core A53	Dual core A73+Dual core A53	Dual core A73+Dual core A53
	Memory	3 GB	3 GB	3 GB
	Storage	16 GB	16 GB	16 GB
Other Connectivity	USB	2.0 x 3 / 3.0 x 3	2.0 x 3 / 3.0 x 3	2.0 x 3 / 3.0 x 3
Audio	Audio In	Stereo Audio Jack (3.5 mm)	Stereo Audio Jack (3.5 mm)	Stereo Audio Jack (3.5 mm)
	Audio Out	Stereo Audio Jack (3.5 mm) S/PDIF	Stereo Audio Jack (3.5 mm) S/PDIF	Stereo Audio Jack (3.5 mm) S/PDIF
	Internal Speakers	16W x 2	16W x 2	16W x 2
Touch Screen	Technology	Infrared Touch Frame	Infrared Touch Frame	Infrared Touch Frame
	Positional Accuracy	±1.5mm	±1.5mm	±1.5mm
	Panel Interface	USB 2.0 x 2 (Type-B)	USB 2.0 x 2 (Type-B)	USB 2.0 x 2 (Type-B)
	Single-touch Plug & Play	Windows 2000/XP/Vista/CE 6.0/macOS	Windows 2000/XP/Vista/CE 6.0/macOS	Windows 2000/XP/Vista/CE 6.0/macOS
	Multi-touch Plug & Play	Windows 7/8/10 Android/Linux (kernel version 3.5+) Chrome OS (39 or above)	Windows 7/8/10 Android/Linux (kernel version 3.5+) Chrome OS (39 or above)	Windows 7/8/10 Android/Linux (kernel version 3.5+) Chrome OS (39 or above)
	Multi-touch Support by Driver	macOS (supported by UPDD driver)	macOS (supported by UPDD driver)	macOS (supported by UPDD driver)
Power	Power Supply	Internal	Internal	Internal
	Power Requirements	AC 100-240V, 50/60 Hz	AC 100-240V, 50/60 Hz	AC 100-240V, 50/60 Hz
	On Mode	155W	165W	294W
	Off Mode	< 0.5W	< 0.5W	< 0.5W
Glass	Thickness	4.0 mm (0.16")	4.0 mm (0.16")	4.0 mm (0.16")
	Rejection Rate	< 10%	< 10%	< 10%
	Transmission Rate	≥ 88%	≥ 88%	≥ 88%
	Hardness	≥ 8H	≥ 8H	≥ 8H
Operating Conditions	Temperature	0°C-40°C (32°F-104°F)	0°C-40°C (32°F-104°F)	0°C-40°C (32°F-104°F)
	Humidity	10%-90% (non-condensing)	10%-90% (non-condensing)	10%-90% (non-condensing)
Storage Conditions	Temperature	-20°C-60°C (-4°F-140°F)	-20°C-60°C (-4°F-140°F)	-20°C-60°C (-4°F-140°F)
	Humidity	10%-90% (non-condensing)	10%-90% (non-condensing)	10%-90% (non-condensing)
Mounting	VESA FPMPMI	Yes (600 x 400 mm)	Yes (800 x 400 mm)	Yes (800 x 600 mm)

SPECIFICATIONS

		IFP-6502	IFP-7502	IFP-8602
Dimensions	w/o Base (W x H x D)	1489.0 x 897.0 x 86.0 mm (58.6" x 35.3" x 3.4")	1710.0 x 1020.0 x 86.0 mm (67.3" x 40.2" x 3.4")	1957.2 x 1160.0 x 86.0 mm (77.1" x 45.6" x 3.4")
	Packaging (W x H x D)	1656.0 x 1050.0 x 204.0 mm (65.2" x 41.3" x 8.0")	1860.0 x 1140.0 x 280.0 mm (73.2" x 44.9" x 11.0")	2211.0 x 1370.0 x 280.0 mm (87.1" x 53.9" x 11.0")
Weight	w/o Base	39.0 kg (86.0 lb)	50.6 kg (111.6 lb)	66.0kg (145.5 lb)
	Packaging	55.7 kg (122.8 lb)	72.9 kg (160.7 lb)	98.8kg (217.8 lb)

Note:

- ◆ All specifications are subject to change without prior notice.

8.2 Display Dimensions

IFP-6502

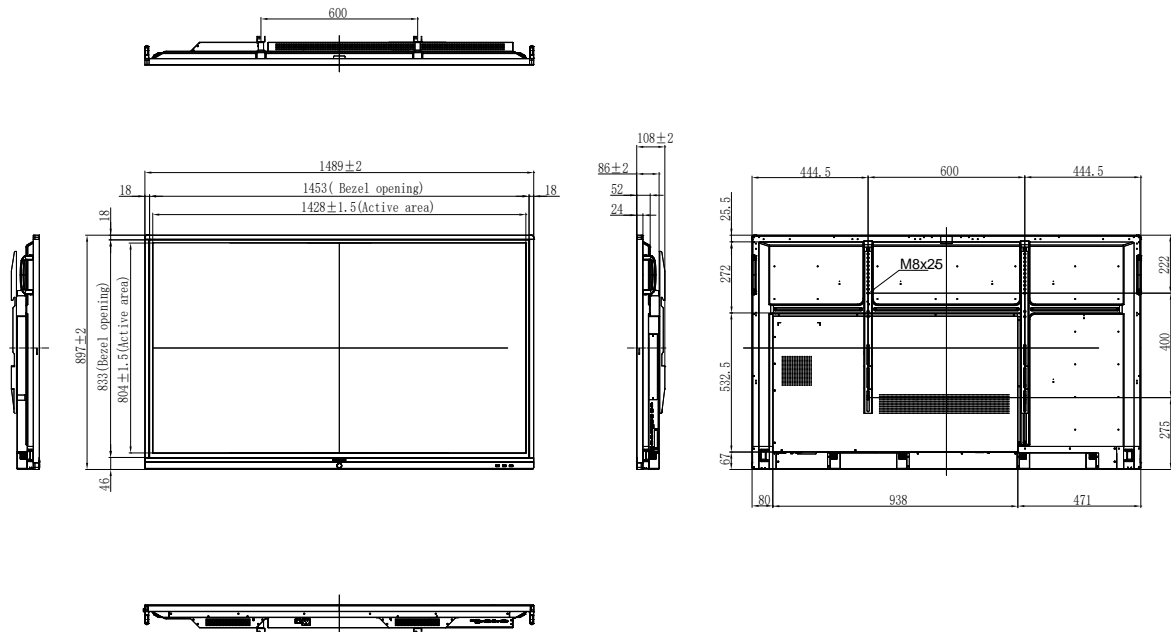

SPECIFICATIONS

IFP-7502

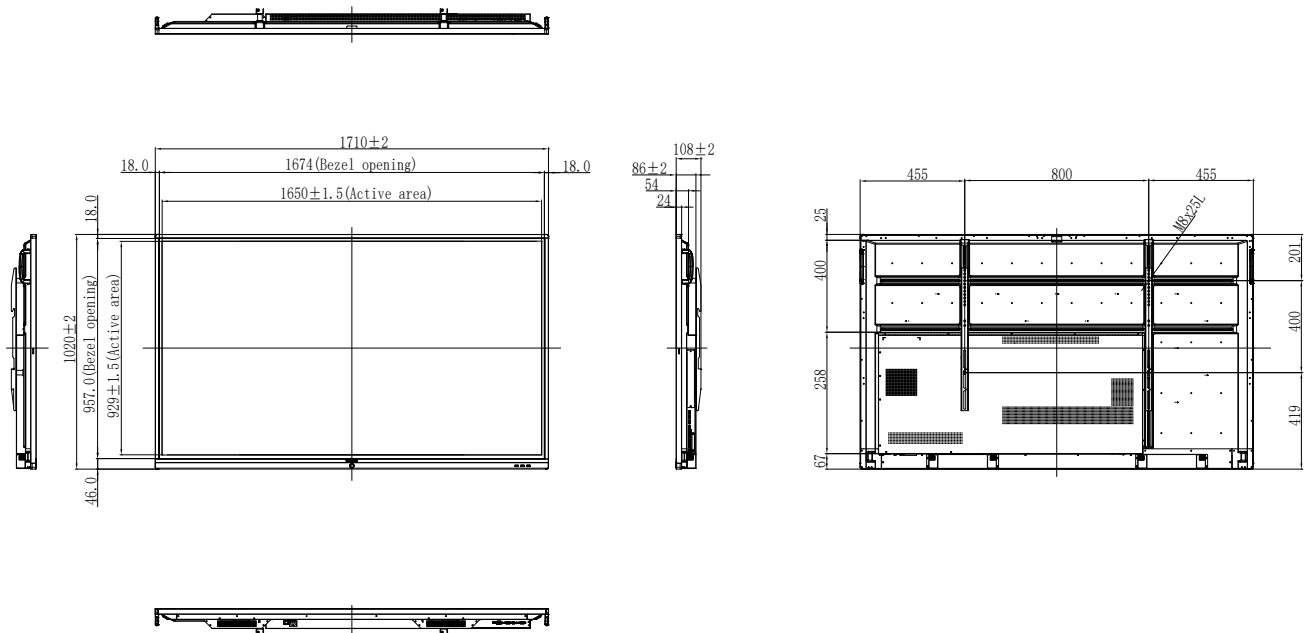

IFP-8602

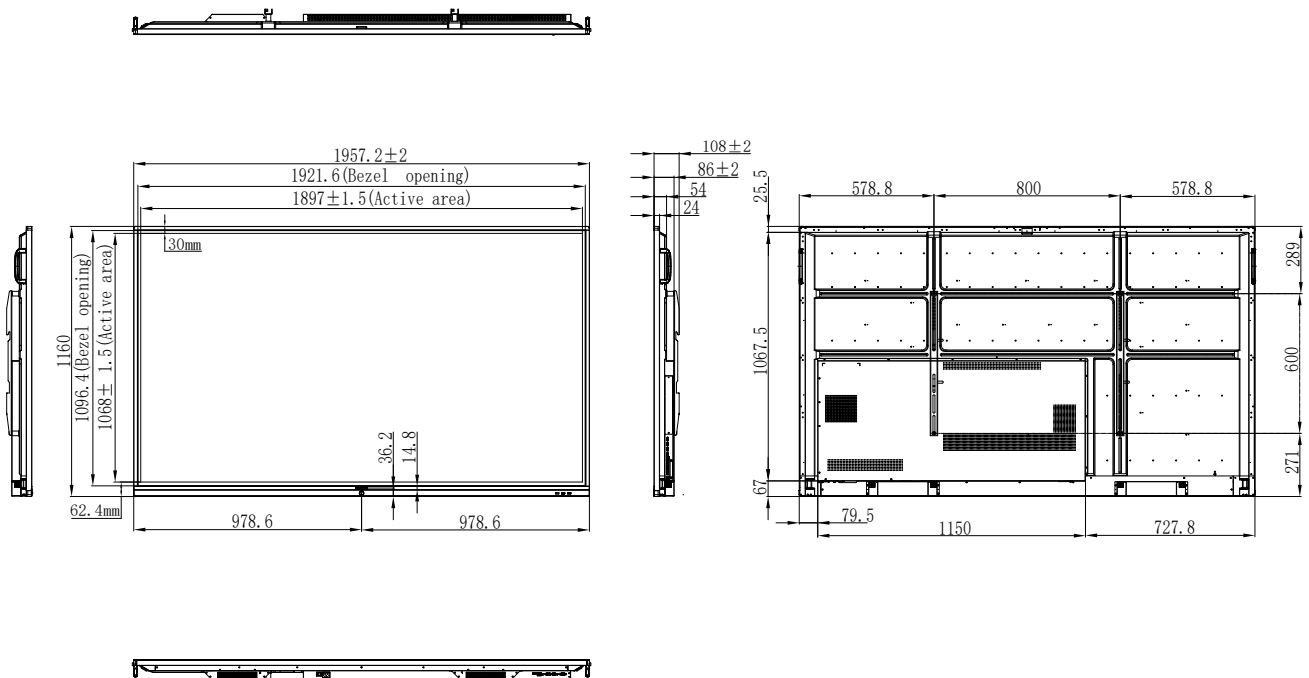

AG Neovo

Company Address: 5F-1, No. 3-1, Park Street, Nangang District, Taipei, 11503, Taiwan.

Copyright © 2020 AG Neovo. All rights reserved.

IF8620/IF7200/IF6200_UM_V011