



KRAMER ELECTRONICS LTD.

USER MANUAL

MODEL:

Yarden 5-0 (SPK-W512T-K)
On-Wall Speakers

P/N: 2900-300352 Rev 2



Yarden 5-O Quick Start Guide

This guide helps you install and use your product for the first time. For more detailed information, go to http://www.kramerelectronics.com/support/product_downloads.asp to download the latest manual or scan the QR code on the left.

Step 1: Check what's in the box

- Yarden 5-O On-wall Speakers
- 2 Mounting brackets
- 4 knobs
- 4 Mounting screws
- 1 Quick start guide

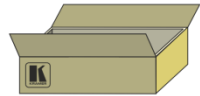

Save the original box and packaging materials in case you need to return your product for service.

Step 2: Choose the best location

Before installing the speakers:

- Experiment by placing the speakers in different locations before finally deciding on the most suitable location
- Be sure that the wall type is appropriate for the mounting brackets, that is, either solid wood, bricks, concrete, hollow building blocks, or wood studs
- Check that the mounting location is free of obstructions, such as electrical piping, AC ducts or water lines, and so on

Step 3: Install the speakers

To install the speakers:

- Cut the wires to similar lengths, leaving some access wire to easily remove the speakers from the brackets (the Kramer BCP-2S cable is recommended)
- Connect the mounting brackets
- Adjust the tap setting

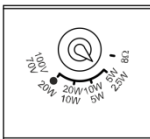

- Connect the wires to the appropriate terminal

For best results, we recommend that you always use Kramer high-performance cables to connect AV equipment to your speakers

Always switch OFF the power on each device before connecting it to your Speakers.

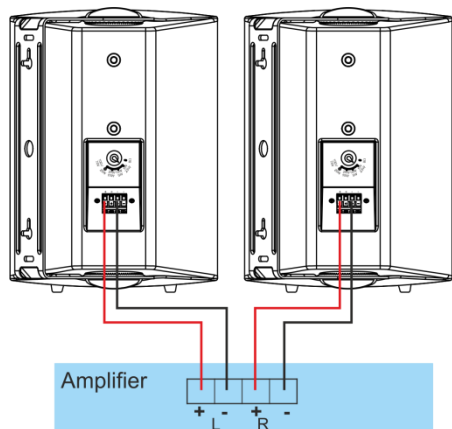

Contents

1	Introduction	1
2	Getting Started	2
2.1	Achieving the Best Performance	2
2.2	Recycling Kramer Products	3
3	Overview	4
3.1	Defining the Yarden 5-O	5
4	Installing the Yarden 5-O	6
4.1	Choosing the Best Location	6
4.2	Installing the Speaker Wires	6
4.3	Installing the Mounting Bracket	7
4.4	Setting up an Array Installation	9
4.5	Connecting the Yarden 5-O	11
5	Technical Specifications	12

Figures

Figure 1:	Yarden 5-O	5
Figure 2:	Adjust Tap Selector	7
Figure 3:	Yarden 5-O with Brackets Connected	8
Figure 4:	Square Layout	9
Figure 5:	Hexagonal Layout	9
Figure 6:	Square Layout Parallel Wiring	10
Figure 7:	Yarden 5-O Installed	11

1 Introduction

Welcome to Kramer Electronics! Since 1981, Kramer Electronics has been providing a world of unique, creative, and affordable solutions to the vast range of problems that confront video, audio, presentation, and broadcasting professionals on a daily basis. In recent years, we have redesigned and upgraded most of our line, making the best even better!

Our 1,000-plus different models now appear in 14 groups that are clearly defined by function: GROUP 1: Distribution Amplifiers; GROUP 2: Switchers and Routers; GROUP 3: Control Systems; GROUP 4: Format/Standards Converters; GROUP 5: Range Extenders and Repeaters; GROUP 6: Specialty AV Products; GROUP 7: Scan Converters and Scalers; GROUP 8: Cables and Connectors; GROUP 9: Room Connectivity; GROUP 10: Accessories and Rack Adapters; GROUP 11: Sierra Video Products; GROUP 12: Digital Signage; GROUP 13: Audio; and GROUP 14: Collaboration.

Congratulations on purchasing your Kramer **Yarden 5-O** On-Wall Speakers, which are ideal for:

- Conference rooms
- Boardrooms and classrooms
- Multimedia systems
- Hotels
- Restaurants and shops

2 Getting Started

We recommend that you:

- Unpack the equipment carefully and save the original box and packaging materials for possible future shipment
- Review the contents of this user manual



Go to http://www.kramerelectronics.com/support/product_downloads.asp to check for up-to-date user manuals, application programs, and to check if firmware upgrades are available (where appropriate).

2.1 Achieving the Best Performance

To achieve the best performance:

- Use only good quality connection cables (we recommend Kramer high-performance, high-resolution cables) to avoid interference, deterioration in signal quality due to poor matching, and elevated noise levels (often associated with low quality cables)
- Do not secure the cables in tight bundles or roll the slack into tight coils
- Avoid interference from neighboring electrical appliances that may adversely influence signal quality
- Position your Kramer Speakers away from moisture, excessive sunlight and dust



This equipment is to be used only inside a building. It may only be connected to other equipment that is installed inside a building.



Do not open the housing of the speaker; doing so may reduce the quality of the sound.

2.2 Recycling Kramer Products

The Waste Electrical and Electronic Equipment (WEEE) Directive 2002/96/EC aims to reduce the amount of WEEE sent for disposal to landfill or incineration by requiring it to be collected and recycled. To comply with the WEEE Directive, Kramer Electronics has made arrangements with the European Advanced Recycling Network (EARN) and will cover any costs of treatment, recycling and recovery of waste Kramer Electronics branded equipment on arrival at the EARN facility. For details of Kramer's recycling arrangements in your particular country go to our recycling pages at <http://www.kramerelectronics.com/support/recycling/>.

3 Overview

The **Yarden 5-O** includes a pair of high performance indoor on-wall speakers that can be mounted on the wall either vertically or horizontally. The mounting brackets, made of painted steel, can be attached to each speaker, letting you rotate each speaker from side to side. The **Yarden 5-O** speakers feature a multi-tap power transformer for selecting 8Ω (bypassing the transformer) or 70V/100V power settings that are suitable for an array installation.

3.1 Defining the Yarden 5-O

This section defines the **Yarden 5-O**:

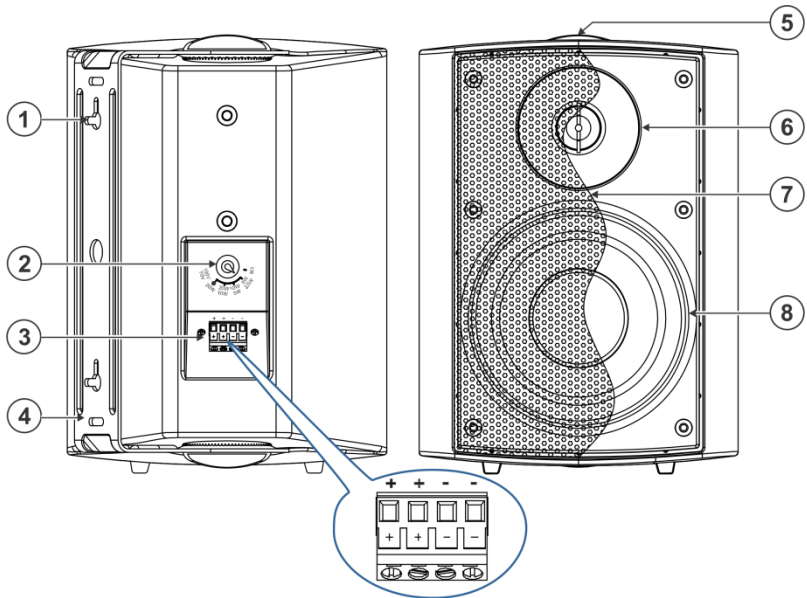

Figure 1: Yarden 5-O

#	Feature	Function
1	Mounting screw opening	Provides the ability to hang the Speaker on the wall
2	Tap Selector	Adjust each speaker to the appropriate tap setting: For 70V, 2.5W 5W, 10W or 20W; for 100V, select 5W, 10W or 20W or select 8Ω (to bypass the transformer when connecting directly to an amplifier without using the 70/100V array option)
3	Input and Output Terminal Block Connectors	One +, - pair for the input and the other pair to output to the next speaker in an array configuration (see Section 4.4)
4	Bracket	Use to mount the speaker onto the wall
5	Bracket Knobs (2)	Use two knobs to fasten the bracket to the speaker
6	Tweeter	Reproduces the higher frequency sounds
7	Speaker Grille	Protects the internal components of the speaker from foreign objects. Do not remove this from the speakers
8	Woofer Driver	Reproduces low frequencies

4 Installing the Yarden 5-O

This section explains how to:

- Choose the best location for your speakers (see [Section 4.1](#))
- Install the speaker wires (see [Section 4.2](#))
- Install the mounting brackets (see [Section 4.3](#))
- Setup an array installation (see [Section 4.4](#))
- Install the **Yarden 5-O** (see [Section 4.5](#))

4.1 Choosing the Best Location

Before installing the speakers:

- Experiment by placing the speakers in different locations before finally deciding on the most suitable location
- Be sure that the wall type is appropriate for the mounting brackets, that is, either solid wood, bricks, concrete, hollow building blocks, or wood studs
- Check that the mounting location is free of obstructions, such as electrical piping, AC ducts or water lines, and so on

4.2 Installing the Speaker Wires

To install the speakers, do the following:

1. Prepare the wires for the speakers:
 - Cut the wires to similar lengths
For achieving high quality sound
 - Measure the length from each speaker to the receiver, and cut the wires accordingly, adding some access wire length to let you easily remove the speakers from the bracket without having to disconnect the input wires
2. Strip the ends of the wires to expose a length of approximately 3/8 inch.

3. Pass the speaker wires through the round hole in the mounting bracket (see [Section 4.3](#)).
4. Adjust each speaker to the appropriate tap setting (see [Figure 2](#)).
Set the tap according to the power requirements of the speaker based on its location in the room (for example, a speaker located in a remote corner may require additional power)

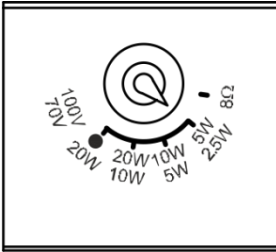

Figure 2: Adjust Tap Selector

5. Connect one of the + and – terminal block pairs on the rear panel (see [Figure 1](#)) by connecting the:
 - Wire from the negative terminal on the receiver into the negative terminal block of the speaker
 - Wire from the positive terminal on the receiver into the positive terminal block of the speaker
6. Repeat step 5 for the other speaker (see [Figure 7](#)).
7. If required, connect the + and - terminal blocks to the + and - terminal blocks to an adjacent speaker (as illustrated in the example in [Figure 6](#)).

4.3 Installing the Mounting Bracket

To install the mounting brackets, do the following:

1. Mark the location of the mounting holes on the wall.
2. Screw the mounting screws onto the wall at the location that you want to mount the speakers.
If the location is backed by wall studs, you can use the wood screws provided. If the location is backed by a gypsum board, use wall anchors (not included in the package).

3. Slide a speaker into each mounting bracket.
4. Align the bracket screw holes (upper and lower) to those on the speaker and screw a knob to each of the holes to secure the speaker to the bracket (see [Figure 3](#)).

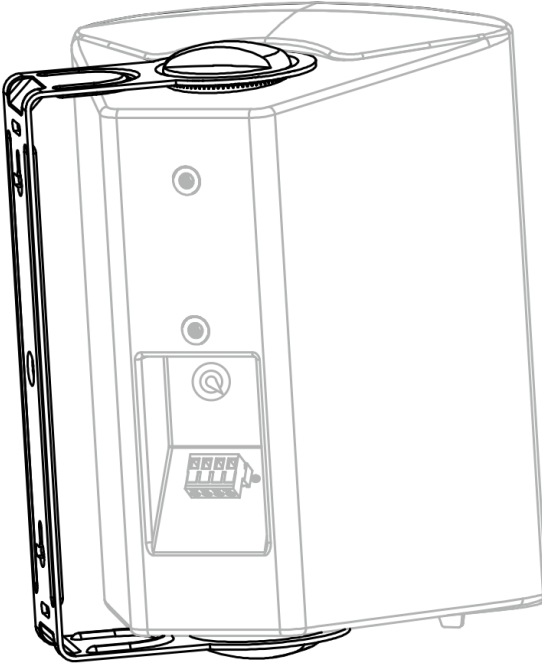

Figure 3: Yarden 5-O with Brackets Connected

5. Slide the mounting bracket over the mounting screws so that the mounting bracket is secured to the surface.
6. You can slightly loosen the knobs on a speaker to adjust its direction.

4.4 Setting up an Array Installation

When installing the **Yarden 5-O** in an array installation layout, you need to define the distance between speakers as well as the layout pattern (square or hexagonal). The distance between speakers is set according to the uniformity of the coverage desired and the budget.

The coverage angle of the speaker determines the coverage area and the number of speakers required in the array installation. Two patterns are usually used for array installations, square (see [Figure 4](#)) or hexagonal (see [Figure 5](#)), depending on the shape of the installation area. The speakers are positioned according to their coverage area.

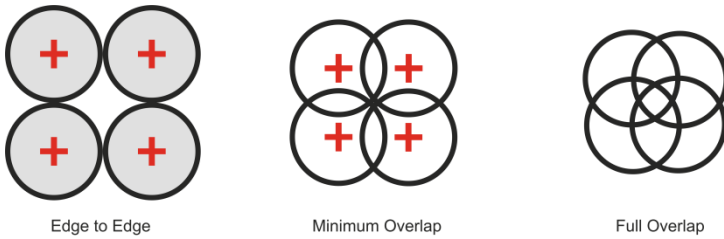

Figure 4: Square Layout

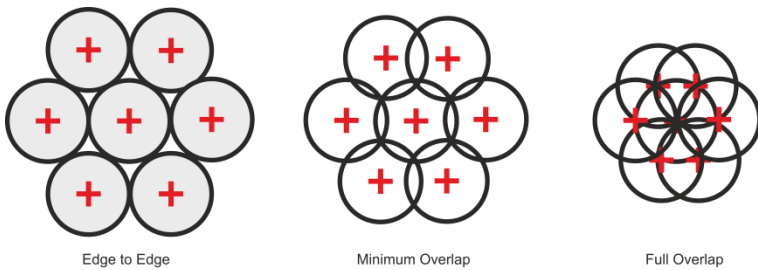

Figure 5: Hexagonal Layout

You can set the power on each speaker to get the desired power level in different installation areas.

Figure 6 shows an example of parallel wiring in a square array installation:

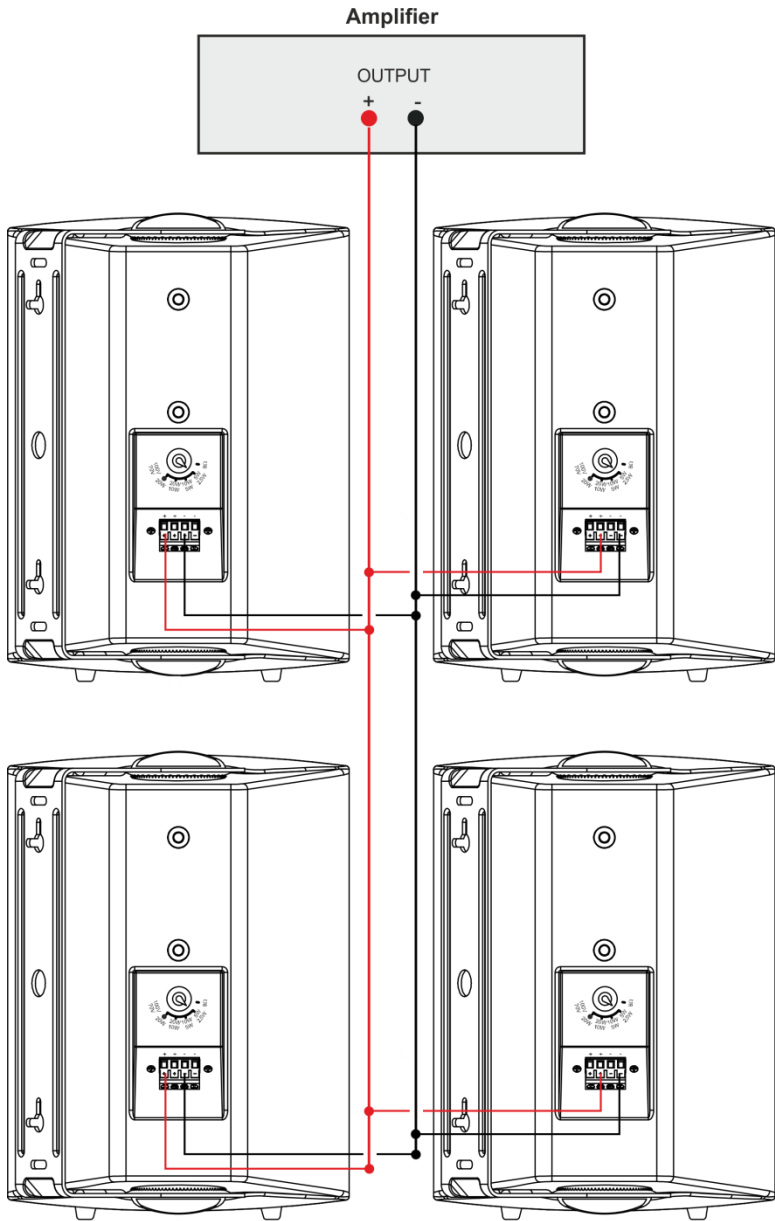

Figure 6: Square Layout Parallel Wiring

4.5 Connecting the Yarden 5-O

You can connect the **Yarden 5-O** speakers to an amplifier, for example the Kramer **907xI** Power Amplifier/Mixer, as illustrated in [Figure 7](#):

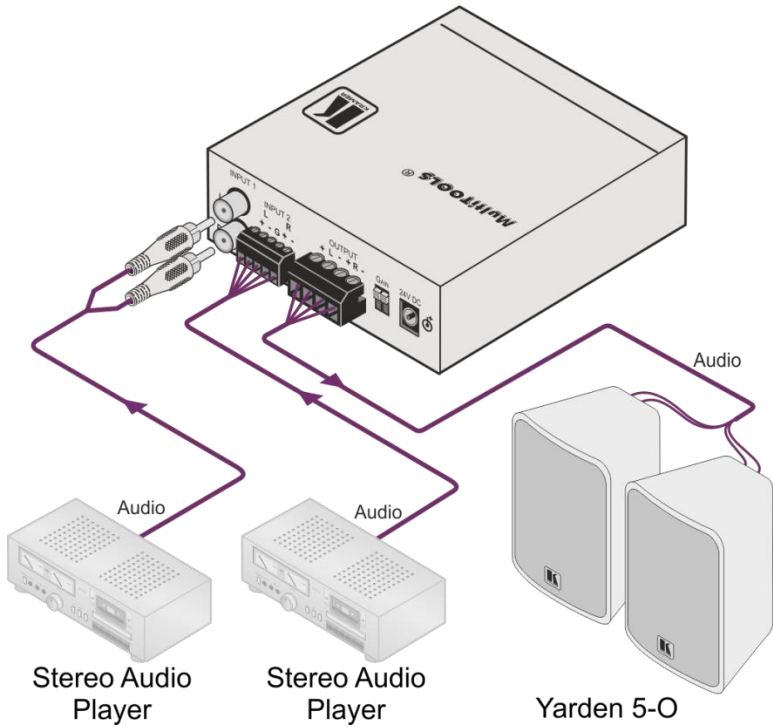

Figure 7: Yarden 5-O Installed

5 Technical Specifications

Audio and Power	
DESCRIPTION:	2-way on-wall speakers
FREQUENCY RESPONSE:	80Hz to 20kHz @ -10dB 100Hz to 20kHz @ ±3dB
WOOFER:	5.25" (133mm) Kevlar(R) with rubber surround
TWEETER:	0.5" (13mm) Mylar
IMPEDANCE:	8Ω (transformer tap in off position)
TRANSFORMER TAPS:	70V – 20W / 10W / 5W / 2.5W / Off (Lo-Z) 100V – 20W / 10W / 5W / Off (Lo-Z)
SENSITIVITY:	88dB SPL, 1W@1m
MAX SPL:	Continuous: 101dB Peak: 104dB
POWER HANDLING:	30W RMS 80W continuous program
CROSSOVER FREQUENCY:	9kHz
DIRECTIVITY FACTOR (Q):	4, averaged 1kHz to 10kHz
DIRECTIVITY INDEX (DI)	6dB averaged 1kHz to 10kHz
INPUT CONNECTORS:	Terminal blocks
Shipping and Installation	
MATERIALS:	Frame, aluminum grill, steel brackets and ABS cabinet
OPERATING TEMPERATURE:	0° to +40°C (32° to 104°F)
STORAGE TEMPERATURE:	-40° to +70°C (-40° to 158°F)
HUMIDITY:	10% to 90%, RHL non-condensing
WEIGHT PER SINGLE SPEAKER:	2.15kg (4.7lbs) approx.
WEIGHT WITH MOUNTING KIT:	2.3kg (5.1lbs) approx.
SHIPPING WEIGHT (FOR PAIR):	5.3kg (11.7lbs) approx.
DIMENSIONS:	18.4cm x 16.7cm x 24.5cm (7.24" x 6.6" x 9.65"), W, D, H
DIMENSIONS with mounting brackets:	18.4cm x 19.0cm x 24.5cm (7.24" x 7.5" x 9.65"), W, D, H
INSTALLATION CLEARANCE:	Front panel to wall (with mounting bracket): 18.7 cm (7.4") Back panel to wall (with mounting bracket): 2.4 cm (0.9")
ACCESSORIES:	2 mounting brackets (including 4 knobs and 4 mounting screws)
OPTIONS:	BCP-2S speaker cable
COLORS:	Available in white
Specifications are within a 10% tolerance and are subject to change without notice at http://www.kramerelectronics.com	

LIMITED WARRANTY

The warranty obligations of Kramer Electronics for this product are limited to the terms set forth below:

What is Covered

This limited warranty covers defects in materials and workmanship in this product.

What is Not Covered

This limited warranty does not cover any damage, deterioration or malfunction resulting from any alteration, modification, improper or unreasonable use or maintenance, misuse, abuse, accident, neglect, exposure to excess moisture, fire, improper packing and shipping (such claims must be presented to the carrier), lightning, power surges, or other acts of nature. This limited warranty does not cover any damage, deterioration or malfunction resulting from the installation or removal of this product from any installation, any unauthorized tampering with this product, any repairs attempted by anyone unauthorized by Kramer Electronics to make such repairs, or any other cause which does not relate directly to a defect in materials and/or workmanship of this product. This limited warranty does not cover cartons, equipment enclosures, cables or accessories used in conjunction with this product.

Without limiting any other exclusion herein, Kramer Electronics does not warrant that the product covered hereby, including, without limitation, the technology and/or integrated circuit(s) included in the product, will not become obsolete or that such items are or will remain compatible with any other product or technology with which the product may be used.

How Long Does this Coverage Last

One year as of this printing; please check our Web site for the most current and accurate warranty information.

Who is Covered

Only the original purchaser of this product is covered under this limited warranty. This limited warranty is not transferable to subsequent purchasers or owners of this product.

What Kramer Electronics will do

Kramer Electronics will, at its sole option, provide one of the following three remedies to whatever extent it shall deem necessary to satisfy a proper claim under this limited warranty:

1. Elect to repair or facilitate the repair of any defective parts within a reasonable period of time, free of any charge for the necessary parts and labor to complete the repair and restore this product to its proper operating condition. Kramer Electronics will also pay the shipping costs necessary to return this product once the repair is complete.
2. Replace this product with a direct replacement or with a similar product deemed by Kramer Electronics to perform substantially the same function as the original product.
3. Issue a refund of the original purchase price less depreciation to be determined based on the age of the product at the time remedy is sought under this limited warranty.

What Kramer Electronics will not do Under This Limited Warranty

If this product is returned to Kramer Electronics or the authorized dealer from which it was purchased or any other party authorized to repair Kramer Electronics products, this product must be insured during shipment, with the insurance and shipping charges prepaid by you. If this product is returned uninsured, you assume all risks of loss or damage during shipment. Kramer Electronics will not be responsible for any costs related to the removal or re-installation of this product from or into any installation. Kramer Electronics will not be responsible for any costs related to any setting up this product, any adjustment of user controls or any programming required for a specific installation of this product.

How to Obtain a Remedy under this Limited Warranty

To obtain a remedy under this limited warranty, you must contact either the authorized Kramer Electronics reseller from whom you purchased this product or the Kramer Electronics office nearest you. For a list of authorized Kramer Electronics resellers and/or Kramer Electronics authorized service providers, please visit our web site at www.kramerelectronics.com or contact the Kramer Electronics office nearest you.

In order to pursue any remedy under this limited warranty, you must possess an original, dated receipt as proof of purchase from an authorized Kramer Electronics reseller. If this product is returned under this limited warranty, a return authorization number, obtained from Kramer Electronics, will be required. You may also be directed to an authorized reseller or a person authorized by Kramer Electronics to repair the product.

If it is decided that this product should be returned directly to Kramer Electronics, this product should be properly packed, preferably in the original carton, for shipping. Cartons not bearing a return authorization number will be refused.

Limitation on Liability

THE MAXIMUM LIABILITY OF KRAMER ELECTRONICS UNDER THIS LIMITED WARRANTY SHALL NOT EXCEED THE ACTUAL PURCHASE PRICE PAID FOR THE PRODUCT. TO THE MAXIMUM EXTENT PERMITTED BY LAW, KRAMER ELECTRONICS IS NOT RESPONSIBLE FOR DIRECT, SPECIAL, INCIDENTAL OR CONSEQUENTIAL DAMAGES RESULTING FROM ANY BREACH OF WARRANTY OR CONDITION, OR UNDER ANY OTHER LEGAL THEORY. Some countries, districts or states do not allow the exclusion or limitation of relief, special, incidental, consequential or indirect damages, or the limitation of liability to specified amounts, so the above limitations or exclusions may not apply to you.

Exclusive Remedy

TO THE MAXIMUM EXTENT PERMITTED BY LAW, THIS LIMITED WARRANTY AND THE REMEDIES SET FORTH ABOVE ARE EXCLUSIVE AND IN LIEU OF ALL OTHER WARRANTIES, REMEDIES AND CONDITIONS, WHETHER ORAL OR WRITTEN, EXPRESS OR IMPLIED. TO THE MAXIMUM EXTENT PERMITTED BY LAW, KRAMER ELECTRONICS SPECIFICALLY DISCLAIMS ANY AND ALL IMPLIED WARRANTIES, INCLUDING, WITHOUT LIMITATION, WARRANTIES OF MERCHANTABILITY AND FITNESS FOR A PARTICULAR PURPOSE. IF KRAMER ELECTRONICS CANNOT LAWFULLY DISCLAIM OR EXCLUDE IMPLIED WARRANTIES UNDER APPLICABLE LAW, THEN ALL IMPLIED WARRANTIES COVERING THIS PRODUCT, INCLUDING WARRANTIES OF MERCHANTABILITY AND FITNESS FOR A PARTICULAR PURPOSE, SHALL APPLY TO THIS PRODUCT AS PROVIDED UNDER APPLICABLE LAW.

IF ANY PRODUCT TO WHICH THIS LIMITED WARRANTY APPLIES IS A "CONSUMER PRODUCT" UNDER THE MAGNUSON-MOSS WARRANTY ACT (15 U.S.C.A. §2301, ET SEQ.) OR OTHER APPLICABLE LAW, THE FOREGOING DISCLAIMER OF IMPLIED WARRANTIES SHALL NOT APPLY TO YOU, AND ALL IMPLIED WARRANTIES ON THIS PRODUCT, INCLUDING WARRANTIES OF MERCHANTABILITY AND FITNESS FOR THE PARTICULAR PURPOSE, SHALL APPLY AS PROVIDED UNDER APPLICABLE LAW.

Other Conditions

This limited warranty gives you specific legal rights, and you may have other rights which vary from country to country or state to state.

This limited warranty is void if (i) the label bearing the serial number of this product has been removed or defaced, (ii) the product is not distributed by Kramer Electronics or (iii) this product is not purchased from an authorized Kramer Electronics reseller. If you are unsure whether a reseller is an authorized Kramer Electronics reseller, please visit our Web site at www.kramerelectronics.com or contact a Kramer Electronics office from the list at the end of this document.

Your rights under this limited warranty are not diminished if you do not complete and return the product registration form or complete and submit the online product registration form. Kramer Electronics thanks you for purchasing a Kramer Electronics product. We hope it will give you years of satisfaction.

This page is intentionally left blank



For the latest information on our products and a list of Kramer distributors, visit our Web site where updates to this user manual may be found.

We welcome your questions, comments, and feedback.

Web site: www.kramerelectronics.com

E-mail: info@kramerel.com



SAFETY WARNING

Disconnect the unit from the power supply before opening and servicing

P/N:



2900-300352

Rev:



2