



KRAMER ELECTRONICS LTD.

USER MANUAL

MODEL:

VP-774AMP

Presentation Switcher/Scaler

P/N: 2900-300324 Rev 2



VP-774AMP Quick Start Guide

This guide helps you install and use your product for the first time. For more detailed information, go to <http://bit.ly/k-prod-downloads> to download the latest manual or scan the QR code on the left.

Step 1: Check what's in the box

- The **VP-774AMP** Presentation Switcher/Scaler
- 1 Power cord
- 1 Set of ear racks
- IR remote control transmitter with batteries
- 1 Quick start guide
- 4 Rubber feet

Save the original box and packaging materials in case you need to return your product for service.

Step 2: Install the VP-774AMP

To rack mount the machine attach both ear brackets to the machine (by removing the three screws from each side of the machine and replacing those screws through the ear brackets) or place the machine on a table.

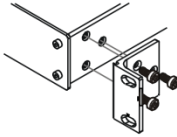

Step 3: Connect inputs and outputs

Always switch OFF the power on each device before connecting it to your **VP-774AMP**. For best results, we recommend that you always use Kramer high-performance cables to connect AV equipment to the **VP-774AMP**.

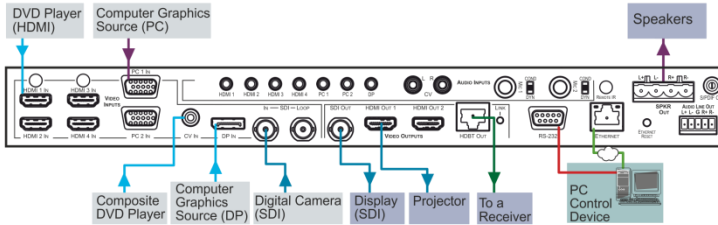

RJ-45 Pinout

For the Ethernet and HDBaseT connectors, see the proper wiring diagram below



EIA / TIA 568B	
PIN	Wire Color
1	Orange / White
2	Orange
3	Green / White
4	Blue
5	Blue / White
6	Green
7	Brown / White
8	Brown

For optimum range and performance use Kramer's **BC-HDKat6a** cable. This specially built cable significantly outperform regular CAT 5/CAT 6 cables.

Mic Pinout

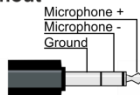

Audio Input Pinout

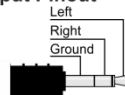

Line Output Pinout

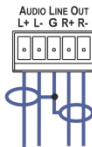

Balanced stereo audio output

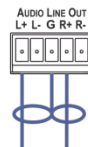

Balanced stereo audio output to unbalanced acceptor

Step 4: Connect the power

Connect AC power to the rear of the **VP-774AMP**, switch on its power and then switch on the power on each device.



Step 5: Set operation parameters via OSD menu

Enter the OSD menu via the MENU button on the front panel or the IR remote control transmitter. Select a menu item and set parameters as required. Sub-menus include: **Input, Audio, Process, Picture, Enhance, Scale and Misc**

Note: By default the output resolution is set to Native, the **VP-774AMP** is triggered to read the EDID of the main display and change the output resolution value according to the native resolution of the display.

If you cannot see any images, verify that the display, TV, or projector is in good working order and is connected to the **VP-774AMP**. If you still don't see an image, press and hold the **RESET TO XGA/720P** button for 2 seconds to reset the output to XGA or 720p resolution.

Notable menu items include: Output Resolution, EDID Input Setting, HDCP Input Setting, Emergency Alert.

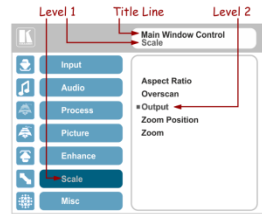

Step 6: Operate via the front panel buttons and via the:

IR Remote



RS-232 and Ethernet

RS-232		
Protocol	3000 (Default)	Legacy
Baud Rate:	115,200	9,600
Data Bits:	8	6
Stop Bits:	1	1
Parity:	None	None
Command Format:	ASCII	ASCII
Example (Set display mode to Picture in Picture):	>Y 0,110,1<CR>	>Y 0 110 1<CR>
Ethernet		
To reset the IP settings to the factory reset values, power cycle the device while holding in the Ethernet Reset button, located on the rear panel of the unit.		
IP Address:	192.168.1.39	
Subnet mask:	255.255.000.000	
Default gateway:	000.000.000.000	
TCP Port #:	9000	
UDP Port #:	90000	
Maximum UDP Ports:	10	
Maximum TCP Ports:	4	
Web page password:	1234	
Full Factory Reset		
Front panel buttons: Turn power off. Turn power on again while holding the RESET TO XGA/720p front panel button. The LEDs blink. Full factory reset is complete once the LEDs cease to blink and read normally. Note that full factory reset includes Ethernet reset as well.		
OSD: Factory reset through the Misc menu item.		
Web pages: Factory reset via the Device Settings embedded Web page		
Protocol 3000: Use "Factory" command or >Y 0,170,1<CR>		

Embedded Web Page

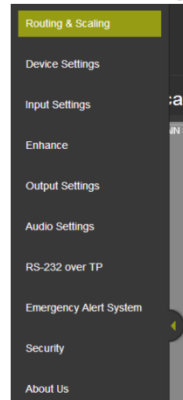

Step 7: Control the display via HDBaseT:

The Port Tunneling feature lets you send RS-232 commands to a serial device connected to the HDBaseT output via the Ethernet port of the **VP-774AMP**.

Commands sent to a dedicated TCP port of the **VP-774AMP** will be forwarded to the RS-232 port on the HDBaseT receiver connected to its output.

To activate port tunneling:

1. Set the dedicated port tunneling Ethernet connection port type and port number through which the **VP-774AMP** will be passing RS-232 signals (**TCP** and **5050**, by default).
2. Use the HDBT UART command to set the communication parameters (**9600**, **8**, **N** and **1**, by default).

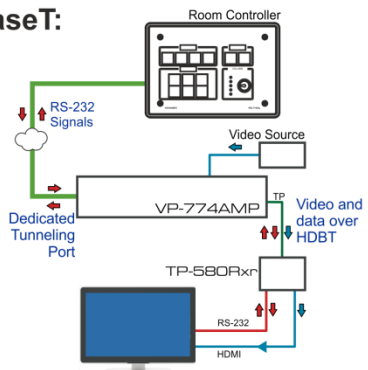

Contents

1	Introduction	1
2	Getting Started	2
2.1	Achieving the Best Performance	2
2.2	Safety Instructions	2
2.3	Recycling Kramer Products	3
3	Overview	4
3.1	HDCP Compliance	7
3.2	About HDBaseT™ Technology	7
3.3	Using Twisted Pair Cable	7
3.4	Defining the VP-774AMP Presentation Switcher/Scaler	7
4	Installing in a Rack	11
5	Connecting the VP-774AMP	12
5.1	Wiring the RJ-45 Connectors	15
5.2	Connecting the Balanced Stereo Audio Output	16
5.3	Microphone Pinout	16
5.4	Audio Input Pinout	16
6	The OSD Menu	17
6.1	OSD Menu Operation Example	17
6.2	The Input Menu	20
6.3	The Audio Menu	27
6.4	The Process Menu	33
6.5	The Picture Menu	34
6.6	The Enhance Menu	35
6.7	The Scale Menu	36
6.8	The Miscellaneous Menu	39
7	The Display Modes	45
7.1	The Single Window Display Mode	45
7.2	The Dual Window Display Mode	45
8	Controlling the VP-774AMP	50
8.1	Controlling via the Front Panel Buttons	50
8.2	Controlling via the OSD Menu	50
8.3	Controlling via the VP-774AMP Web Pages	51
8.4	Controlling via the Infrared Remote Control Transmitter	56
9	Using the Embedded Web Pages	58
9.1	The Routing and Scaling Page	60
9.2	The Device Settings Page	70
9.3	The Input Settings Page	76
9.4	The Enhance Page	79
9.5	The Output Settings	80
9.6	The Audio Settings Page	81
9.7	The RS-232 over TP Page	84
9.8	The Emergency Alert System Page	88
9.9	The Security Page	90
9.10	The About Us Page	91
9.11	Save or Upload a Configuration	91
10	Port Tunneling	93
11	Flash Memory Upgrade	95

12	Technical Specifications	96
12.1	Default Communication Parameters	97
12.2	Input Resolutions	97
12.3	Output Resolutions	99
13	The VP-774AMP RS-232 Communication Protocol	100
13.1	Using the Communication Protocol	100
13.2	Communication Protocol: Mimicking OSD	100
13.3	Protocol Table: Mimicking Remote and Front Panel Buttons	110
13.4	The Protocol 3000 Common Operation Commands	111

Figures

Figure 1:	VP-774AMP Presentation Switcher/Scaler Front Panel	8
Figure 2:	VP-774AMP Presentation Switcher/Scaler Rear Panel	9
Figure 3:	15-pin HD Connector Pinout	12
Figure 4:	Connecting the VP-774AMP Presentation Switcher/Scaler	14
Figure 5:	TP PINOUT	15
Figure 6:	Connecting the Balanced Stereo Audio Output	16
Figure 7:	Connecting an Unbalanced Stereo Audio Acceptor to the Balanced Output	16
Figure 8:	Microphone Pinout	16
Figure 9:	Audio Input Pinout	16
Figure 10:	Input Menu	20
Figure 11:	Select the Display Mode	22
Figure 12:	Changing the Size of the Window	23
Figure 13:	Increasing the Width	24
Figure 14:	Increasing the Height	24
Figure 15:	Positioning the Window	25
Figure 16:	Window Customization	25
Figure 17:	H-Position Slide Bar	26
Figure 18:	Moving the PiP Window	26
Figure 19:	Audio Menu	27
Figure 20:	Set the Output Volume Level	29
Figure 21:	SDI Channeling Example	30
Figure 22:	The SDI Channeling Menu	30
Figure 23:	SDI Channeling Example	31
Figure 24:	SDI bypassed Channels Menu	32
Figure 25:	Process Menu	33
Figure 26:	Picture Menu	34
Figure 27:	Enhance Menu	35
Figure 28:	Scale Menu	36
Figure 29:	Misc Menu	39
Figure 30:	XML File Transfer	43
Figure 31:	Emergency Alert System Display	43
Figure 32:	CV superimposed over DP	48
Figure 33:	Entering the IP Number in the Address Bar	51
Figure 34:	Local Area Connection Properties Window	53
Figure 35:	Internet Protocol Version 4 Properties Window	54
Figure 36:	Internet Protocol Version 6 Properties Window	54
Figure 37:	Internet Protocol Properties Window	55
Figure 38:	Infrared Remote Control Transmitter	56
Figure 39:	The Authentication Window	58
Figure 40:	The Loading Page	59
Figure 41:	The Routing & Scaling Page with Web page list on the left	60

Figure 42: The Routing & Scaling Page – Single Window	60
Figure 43: The Routing & Scaling Page – Moving the PiP Window	61
Figure 44: The Routing & Scaling Page – PiP Window	62
Figure 45: The Routing & Scaling Page – Changing the Resolution	63
Figure 46: The Routing & Scaling Page – The Swap Inputs	64
Figure 47: The Routing & Scaling Page – Swapping the Inputs	64
Figure 48: The Routing & Scaling Page – Auto Switching Window (Main Tab)	65
Figure 49: The Routing & Scaling Page – selecting the Inputs to Scan (PiP Tab)	65
Figure 50: The Routing & Scaling Page – Auto Switching Window	66
Figure 51: The Routing & Scaling Page – Lower Buttons Bar	66
Figure 52: The Routing & Scaling Page – Selecting a Preset	67
Figure 53: The Routing & Scaling Page – Saving the selected Preset	67
Figure 54: The Routing & Scaling Page – Recalling a Preset	68
Figure 55: The Routing & Scaling Page – TAKE Mode	68
Figure 56: The Routing & Scaling Page – Cancel the Changes	69
Figure 57: The Routing & Scaling Page – Audio Level Sliders	69
Figure 58: The Routing & Scaling Page – Muting the Audio Level	69
Figure 59: The Device Settings Page	70
Figure 60: The Device Settings Page – Changing the IP number	70
Figure 61: The Device Settings Page – Selecting the Firmware File	71
Figure 62: The Device Settings Page – Firmware File Downloaded	71
Figure 63: The Device Settings Page – Firmware Upgrade Warning	72
Figure 64: The Device Settings Page – Firmware Upgrade Stage	72
Figure 65: The Device Settings Page – Writing the Firmware	73
Figure 66: The Device Settings Page – Firmware Upgrade Waiting for Restart	73
Figure 67: The Device Settings Page – The Reset Device Window	74
Figure 68: The Device Settings Page – The Reset Device Window Including Ethernet	74
Figure 69: The Device Settings Page – Web Page Reset	75
Figure 70: The Device Settings Page – The Information Window	75
Figure 71: The Input Settings Page	76
Figure 72: The Input Settings Page – PiP Window Inactive	77
Figure 73: The Enhance Page	79
Figure 74: The Output Settings Page	80
Figure 75: The Audio Settings Page – General Tab	81
Figure 76: The Audio Settings Page – Microphones Tab	82
Figure 77: The Audio Settings Page – Microphones Tab	82
Figure 78: The Audio Settings Page – Setting the Mix Level	83
Figure 79: The Audio Settings Page – Output Volume Pre-limiter	83
Figure 80: The RS-232 over TP Page	84
Figure 81: The RS-232 over TP Page – the Remote Device Commands Table	85
Figure 82: The RS-232 over TP Page – the Edit Command Window	85
Figure 83: The RS-232 over TP Page – Setting the Trigger	86
Figure 84: The RS-232 over TP Page – Setting the Sync on Trigger	86
Figure 85: The RS-232 over TP Page – the Power on Command	87
Figure 86: The Emergency Alert System Page	88
Figure 87: The Emergency Alert System Page – Local Message Example	89
Figure 88: The Security Page – Security Deactivated	90
Figure 89: The Security Page – Activating the Security	90
Figure 90: The Security Page – Authentication Required	90
Figure 91: The Security Page	91
Figure 92: The About Us Page	91
Figure 93: Loading a Configuration	92
Figure 94: Saving a Configuration	92
Figure 95: Port Tunneling	93

1 Introduction

Welcome to Kramer Electronics! Since 1981, Kramer Electronics has been providing a world of unique, creative, and affordable solutions to the vast range of problems that confront video, audio, presentation, and broadcasting professionals on a daily basis. In recent years, we have redesigned and upgraded most of our line, making the best even better!

Our 1,000-plus different models now appear in 14 groups that are clearly defined by function: GROUP 1: Distribution Amplifiers; GROUP 2: Switchers and Routers; GROUP 3: Control Systems; GROUP 4: Format/Standards Converters; GROUP 5: Range Extenders and Repeaters; GROUP 6: Specialty AV Products; GROUP 7: Scan Converters and Scalers; GROUP 8: Cables and Connectors; GROUP 9: Room Connectivity; GROUP 10: Accessories and Rack Adapters; GROUP 11: Sierra Video Products; GROUP 12: Digital Signage; GROUP 13: Audio; and GROUP 14: Collaboration.

Congratulations on purchasing your Kramer **VP-774AMP** Presentation Switcher/Scaler. This product, which incorporates HDMI™ technology, is ideal for:

- Projection systems in conference rooms, boardrooms, auditoriums, hotels and churches, production studios, rental and staging
- Any application where high quality conversion and switching of multiple and different video signals to graphical data signals is required for projection purposes

2 Getting Started

We recommend that you:

- Unpack the equipment carefully and save the original box and packaging materials for possible future shipment
- Review the contents of this user manual



Go to http://www.kramerelectronics.com/support/product_downloads.asp to check for up-to-date user manuals, application programs, and to check if firmware upgrades are available (where appropriate).

2.1 Achieving the Best Performance

To achieve the best performance:

- Use only good quality connection cables (we recommend Kramer high-performance, high-resolution cables) to avoid interference, deterioration in signal quality due to poor matching, and elevated noise levels (often associated with low quality cables)
- Do not secure the cables in tight bundles or roll the slack into tight coils
- Avoid interference from neighboring electrical appliances that may adversely influence signal quality
- Position your **VP-774AMP** away from moisture, excessive sunlight and dust



This equipment is to be used only inside a building. It may only be connected to other equipment that is installed inside a building.

2.2 Safety Instructions



Caution: There are no operator serviceable parts inside the unit

Warning: Use only the power cord that is supplied with the unit

Warning: Do not open the unit. High voltages can cause electrical shock! Servicing by qualified personnel only

Warning: Disconnect the power and unplug the unit from the wall before installing

2.3 Recycling Kramer Products

The Waste Electrical and Electronic Equipment (WEEE) Directive 2002/96/EC aims to reduce the amount of WEEE sent for disposal to landfill or incineration by requiring it to be collected and recycled. To comply with the WEEE Directive, Kramer Electronics has made arrangements with the European Advanced Recycling Network (EARN) and will cover any costs of treatment, recycling and recovery of waste Kramer Electronics branded equipment on arrival at the EARN facility. For details of Kramer's recycling arrangements in your particular country go to our recycling pages at <http://www.kramerelectronics.com/support/recycling/>.

3 Overview

The Kramer **VP-774AMP** is a high quality presentation switcher and scaler. It accepts one of nine inputs: an SDI signal on a BNC connector, a DisplayPort (DP) signal on a DisplayPort connector, one composite video signal on an RCA connector, two computer graphics signals on 15-pin HD connectors, and four HDMI signals on HDMI connectors. It scales the video, embeds the audio, and simultaneously outputs the signal as follows: to two HDMI outputs, to an SDI output and to an HDBaseT TP output, together with a digital audio output and a balanced stereo audio output.

The **VP-774AMP** Presentation Switcher / Scaler features:

- PixPerfect™ Scaling Technology – Kramer’s precision pixel mapping and high quality scaling technology. High-quality 3:2 and 2:2 pull down de-interlacing and full up and down scaling of all video input signals
- State-of-the-art video processing technology, with the highest quality de-interlacing, noise reduction, and scaling performance for both standard-definition and high-definition signals
- K-IIT XL™ Picture-in-Picture Image Insertion Technology - Ultra stable picture-in-picture, picture-and-picture and split screen capability, or fully customizable windows’ size and position control: any source can be inserted into or positioned next to any other source and resized as desired
- Ultra-Fast Fade-Thru-Black (FTB™) Switching - Video switching transitions are clean and ultra-fast. The video fades to black and the new input fades from black for smooth, glitch-free switching. The output signal provides constant sync so the display never glitches
- An emergency alert system that can have a national or campus-wide notification immediately displayed when an emergency situation develops, by means of automatic text overlaying, either via a crawler or a full screen cover up, as well as an optional audio alert
- Port tunneling, bidirectional RS-232 interface – simple control commands and data can flow in both directions from a controller to the **VP-774AMP** via the Ethernet, allowing status requests and control of the destination unit
- Advanced deinterlacing functions - including 3D comb filtering, film mode, diagonal correction and motion detection

- Scaled Outputs – 2 HDMI outputs, an SDI output and an HDBaseT TP output simultaneously
- HDBaseT™ technology with a bandwidth of up to 6.75Gbps (2.25Gbps per graphic channel)
- System Range - Up to 130m (430ft) normal mode; up to 180m (590ft) ultra-mode (1080p @60Hz @24bpp) when using **BC-HDKat6a** cables



For optimum range and performance using HDBaseT™, use Kramer's **BC-HDKat6a** cable. Note that the transmission range depends on the signal resolution, source and display used. The distance using non-Kramer CAT 6 cable may not reach these ranges.

- Output Resolutions – HDTV and Computer Graphics up to 2k and 1080p/UXGA with selectable refresh rates
- Multiple Aspect Ratio Selections – Follow input, follow output, best fit, letterbox
- Multi-Standard SDI support - SDI (SMPTE 259M), HD-SDI (SMPTE 292M) and 3G HD-SDI (SMPTE 424M)
- Looping 3G HD-SDI Input
- SDI channeling, letting you select one active audio signal and three bypassed signals from eight embedded stereo audio channels
- Multi-Standard Video support - NTSC (3.58/4.43), PAL (M/N/60) and SECAM
- Built-in Time Base Corrector - Stabilizes unstable video sources
- Built-in Proc-Amp with enhanced functions such as color correction, gamma and dither
- Input and output audio level adjustment
- Balanced stereo audio inputs, with two unbalanced microphone inputs, as well as digital stereo and balanced stereo outputs
- Selectable Microphone talkover or mix modes
- A built-in 2x10W power amplifier with speaker outputs on a 4-pin terminal block connector
- Automatic detection and selection of the HDMI and DP embedded audio. The **VP-774AMP** automatically outputs the signal from the HDMI and DP embedded audio inputs or performs an analog takeover to output the respective analog audio input

- Selectable Power Save modes for energy efficient usage
- HDCP Compliant - The HDCP (High Definition Content Protection) license agreement allows copy-protected data on the HDMI input to pass only to the HDMI and HDBaseT outputs

In addition, the **VP-774AMP** Presentation Switcher / Scaler:

- Includes luma keying via the PiP window
- Features advanced EDID management (native resolution and color depth) per input
- Analyzes the connected output's EDID for optimal scaling
- Auto-positions the input to fit the window perfectly
- Supports picture zooming both on main and PiP window from 100% to 1600%, including separate V and H sharpness control
- Provides input and output color space control
- Supports HDMI deep color for inputs and output
- Features vertical Keystone operation
- Features selectable test patterns
- Comes with an On-Screen Display (OSD) for easy setup and adjustment, accessible via the IR remote control and via the front-panel buttons
- Has a non-volatile memory that retains the last settings used for each input and window combination
- Supports firmware upgrade via RS-232 and Ethernet
- Is HDTV and computer graphics compatible and the resolution can be up- or down-scaled as required (see output resolutions in [Section 6.7](#))

Control your **VP-774AMP**:

- Directly, via the front panel push buttons
- By RS-232 serial commands transmitted by a touch screen system, PC, or other serial controller
- Remotely, from the infrared remote control transmitter
- Via the Ethernet (optionally via the Web pages)

The **VP-774AMP** is housed in a 19" 1U rack mountable enclosure, with rack "ears" included, and is fed from a 100-240 VAC universal switching power supply.

3.1 HDCP Compliance



If an HDMI signal is HDCP protected, it can only appear on HDMI and HDBaseT outputs that are connected to HDCP compliant displays.

The **VP-774AMP** will not output an HDCP protected source to a display that is not HDCP compliant. Instead it will show a green screen.

In the dual window display mode (see [Section 7.2](#)), even if only one of the inputs is HDCP protected, and is output to a non-compliant display, it will affect the entire screen and turn it green.

3.2 About HDBaseT™ Technology

HDBaseT™ is an advanced all-in-one connectivity technology (supported by the HDBaseT Alliance). It is particularly suitable in the ProAV – and also the home – environment as a digital networking alternative, where it enables you to replace numerous cables and connectors by a single LAN cable used to transmit, for example, uncompressed full high-definition video, audio, IR, as well as various control signals.



The products described in this user manual are HDBaseT certified.

3.3 Using Twisted Pair Cable

Kramer engineers have developed special twisted pair cables to best match our digital twisted pair products; **BC-HDKat6a** (CAT 6 23 AWG cable) significantly outperforms regular CAT 5 / CAT 6 cables.



We strongly recommend that you use shielded twisted pair cable.

3.4 Defining the VP-774AMP Presentation Switcher/Scaler

This section defines the **VP-774AMP**.

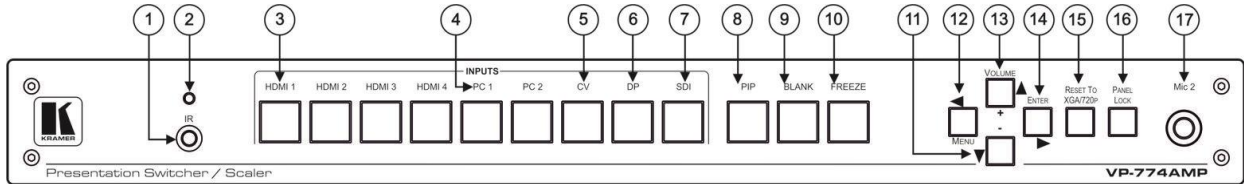

Figure 1: VP-774AMP Presentation Switcher/Scaler Front Panel

#	Feature	Function	
1	IR Receiver	Accepts IR remote commands	
2	IR LED	Lights red when the unit accepts IR remote commands	
3	INPUT Selector Buttons	HDMI	Press to select the HDMI input (from 1 to 4)
4		PC	Press to select the computer graphics input (from 1 to 2)
5		CV	Press to select the composite video input (from 1 to 2)
6		DP	Press to select the Display Port input
7		SDI	Press to select the SDI input
8	PIP Button	Toggles the dual window mode (Picture-in-Picture) function (see Section 7.2) Note that while browsing the OSD menu in the dual window mode, a long press of the PIP button will instantly toggle the window control (between Main and PiP)	
9	BLANK Button	Press to toggle between a blank screen (blue or black screen) and the display	
10	FREEZE Button	Press to freeze/unfreeze the output video image	
11	Navigation Buttons	▼/- Button	Press to move down the menu list (see Section 8.1.1) and to decrease numerical values. When not within the OSD menu mode, press to reduce the output volume
12		◀/MENU Button	Press to access the OSD menu, exit the OSD menu and, when in the OSD menu, move to the previous level in the OSD screen (see Section 8.1.1)
13		▲/+ /VOLUME Button	Press to move up the menu list values (see Section 8.1.1) and to increase numerical values. When not within the OSD menu mode, press to increase the output volume
14		▶/ENTER Button	Press to access sub-menu items and select from several settings (see Section 8.1.1)
15	RESET TO XGA/720P Button	Press to reset the video output resolution to XGA or 720p and change the deep color settings to Off on the output (see Section 6.7) Press and hold for about 3 seconds to toggle between reset to XGA and reset to 720p	
16	PANEL LOCK Button	Press and hold for about 3 seconds to lock/unlock the front panel buttons	
17	Mic 2	Connect to a microphone. Mic2 on the front panel is identical to Mic2 on the rear panel and overrides it when connected	

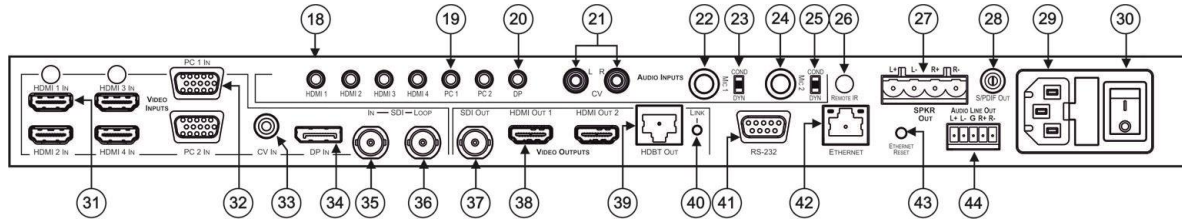

Figure 2: VP-774AMP Presentation Switcher/Scaler Rear Panel

#	Feature	Function
18	AUDIO IN Unbalanced Connectors	HDMI 3.5mm Mini Jack Connect to an unbalanced audio source for audio takeover of the HDMI 1 to HDMI 4 embedded audio (see Section 6.3). The pinout is defined in Section 5.4
19		PC 3.5mm Mini Jack Connect to the unbalanced stereo audio of the computer graphics source (from 1 to 2). The pinout is defined in Section 5.4
20		DP 3.5mm Mini Jack Connect to the unbalanced stereo audio source for analog audio takeover of the DisplayPort embedded audio (see Section 6.3). The pinout is defined in Section 5.4
21		CV (L, R) RCA Connect to the unbalanced stereo audio of the composite video source
22	MIC 1	6mm Jack Connect to a microphone (see pinout in Section 5.3)
23		COND/DYN MIC DIP-switch Select between a condenser and a dynamic type microphone
24		MIC 2
25	COND/DYN MIC DIP-switch Select between a condenser and a dynamic type microphone	
26	REMOTE IR 3.5mm Mini Jack (opening) Covered by a cap. The 3.5mm connector at the end of the internal IR connection cable fits through this opening	Connects to an external IR receiver unit for controlling the machine via an IR remote controller (instead of using the front panel IR receiver) Optional. Can be used instead of the front panel (built-in) IR receiver to remotely control the machine (only if the internal IR connection cable has been installed), see Section 8.4.1
27	SPKR OUT 4-pin Terminal Block	Connects to a pair of loudspeakers
28	S/PDIF OUT RCA Connector	Connect to a digital audio acceptor
29	Power Connector with Fuse	AC connector, enabling power supply to the unit
30	POWER Switch	Switch for turning the unit on or off
31	VIDEO INPUT Connectors	HDMI IN Connect to the HDMI source (from 1 to 4)
32		PC IN 15-pin HD Connect to the computer graphics source (from 1 to 2)

#	Feature	Function
33	CV IN RCA	Connect to the composite video source
34	DP IN	Connect to the DisplayPort source
35	SDI IN BNC	Connect to the SDI source
36	SDI LOOP BNC	Connect to a local display
37	SDI OUT BNC	Connect to an SDI acceptor
38	HDMI OUT	Connect to an HDMI acceptor (from 1 to 2)
39	HDBT OUT RJ-45	Connect to an HDBT receiver (for example, Kramer TP-580Rxr) to pass audio and video signals as well as serial commands
40	LINK LED	Lights to indicate a link
41	RS-232 9-pin D-sub Port	Connect to the PC or other serial controller
42	ETHERNET Connector	Connects to the PC or other Controller through computer networking
43	ETHERNET RESET Button	Press while turning power off and then on, to reset the Ethernet settings to their factory default state (see also Section 12.1)
44	AUDIO LINE OUT (L, R) Terminal Block Connector	Connect to the L and R balanced stereo audio acceptor

4 Installing in a Rack

This section provides instructions for rack mounting the unit.

Before installing in a rack, be sure that the environment is within the recommended range:

OPERATING TEMPERATURE:	0° to +40°C (32° to 104°F)
STORAGE TEMPERATURE:	-40° to +70°C (-40° to 158°F)
HUMIDITY:	10% to 90%, RHL non-condensing



CAUTION!

When installing on a 19" rack, avoid hazards by taking care that:

1. It is located within the recommended environmental conditions, as the operating ambient temperature of a closed or multi unit rack assembly may exceed the room ambient temperature.
2. Once rack mounted, enough air will still flow around the machine.
3. The machine is placed straight in the correct horizontal position.
4. You do not overload the circuit(s). When connecting the machine to the supply circuit, overloading the circuits might have a detrimental effect on overcurrent protection and supply wiring. Refer to the appropriate nameplate ratings for information. For example, for fuse replacement, see the value printed on the product label.
5. The machine is earthed (grounded) in a reliable way and is connected only to an electricity socket with grounding. Pay particular attention to situations where electricity is supplied indirectly (when the power cord is not plugged directly into the socket in the wall), for example, when using an extension cable or a power strip, and that you use only the power cord that is supplied with the machine.

To rack-mount a machine:

1. Attach both ear brackets to the machine. To do so, remove the screws from each side of the machine (3 on each side), and replace those screws through the ear brackets.

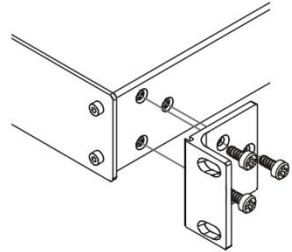

2. Place the ears of the machine against the rack rails, and insert the proper screws (not provided) through each of the four holes in the rack ears.

Note:

- In some models, the front panel may feature built-in rack ears
- Detachable rack ears can be removed for desktop use
- Always mount the machine in the rack before you attach any cables or connect the machine to the power
- If you are using a Kramer rack adapter kit (for a machine that is not 19"), see the Rack Adapters user manual for installation instructions available from our Web site

5 Connecting the VP-774AMP



Always switch off the power to each device before connecting it to your **VP-774AMP**. After connecting your **VP-774AMP**, connect its power and then switch on the power to each device.



You do not have to connect all the inputs and outputs, connect only those that are required.

To connect the **VP-774AMP**, as illustrated in the example in [Figure 4](#), do the following:

1. Connect an HDMI source (for example, a DVD player) to the HDMI 1 IN VIDEO INPUT connector.

Alternatively, you can connect the DVI connector on the DVD player to the HDMI connector on the **VP-774AMP** via a DVI-HDMI adapter. You can connect the audio signal via the AUDIO IN HDMI 3.5mm mini jack, or use the embedded audio

2. Connect a computer graphics source to the PC 1 IN VIDEO INPUT 15-pin HD connector.

Alternatively, you can connect a component (YPbPr) or RGBHV source via the 15-pin HD connector, see [Figure 3](#)

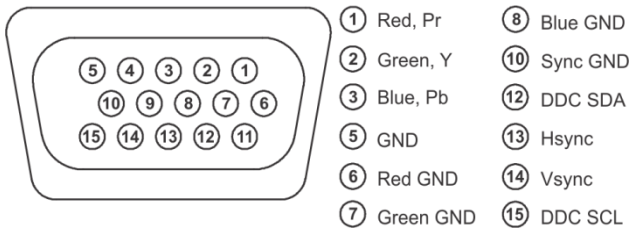

Figure 3: 15-pin HD Connector Pinout

3. Connect a composite video source (for example, a composite video player) to the CV 1 IN RCA connector.
4. Connect a DisplayPort video source (for example, a computer graphics source) to the DP IN connector.
5. Connect the audio input signals to the AUDIO IN connectors (3.5mm mini jack and RCA connectors), as required (not shown in [Figure 4](#)).

6. Connect an SDI source (for example, an SDI digital camera) to the SDI IN BNC connector.
7. Connect the SDI LOOP BNC connector to an SDI monitor (for example, an SDI display).
8. Connect the SDI OUT BNC connector to an SDI acceptor (for example, an SDI display with speakers).
9. Connect the HDMI 1 OUT connector to an HDMI acceptor (for example, an LCD display).
You can also connect the HDMI OUT 2 output (not shown in [Figure 4](#))
10. Connect the HDBT RJ-45 connector to a receiver (for example, the Kramer **TP-580Rxr**).
11. Connect the AUDIO LINE OUT Terminal Block connector to a balanced audio acceptor and the S/PDIF OUT RCA connector to a digital audio acceptor (not shown in [Figure 4](#)).
12. Connect the SPKR OUT block connector to a pair of loudspeakers, by connecting the left loudspeaker to the “L+” and the “L-” terminal block connectors, and the right loudspeaker to the “R+” and the “R-” terminal block connectors. **Do not Ground the loudspeakers.**
13. If required, you can connect a PC and/or controller to the:
 - RS-232 terminal block (see [Section 8.3.2](#))
 - Ethernet connector (see [Section 8.3.3](#))
14. Connect the power cord (not shown in [Figure 4](#)).

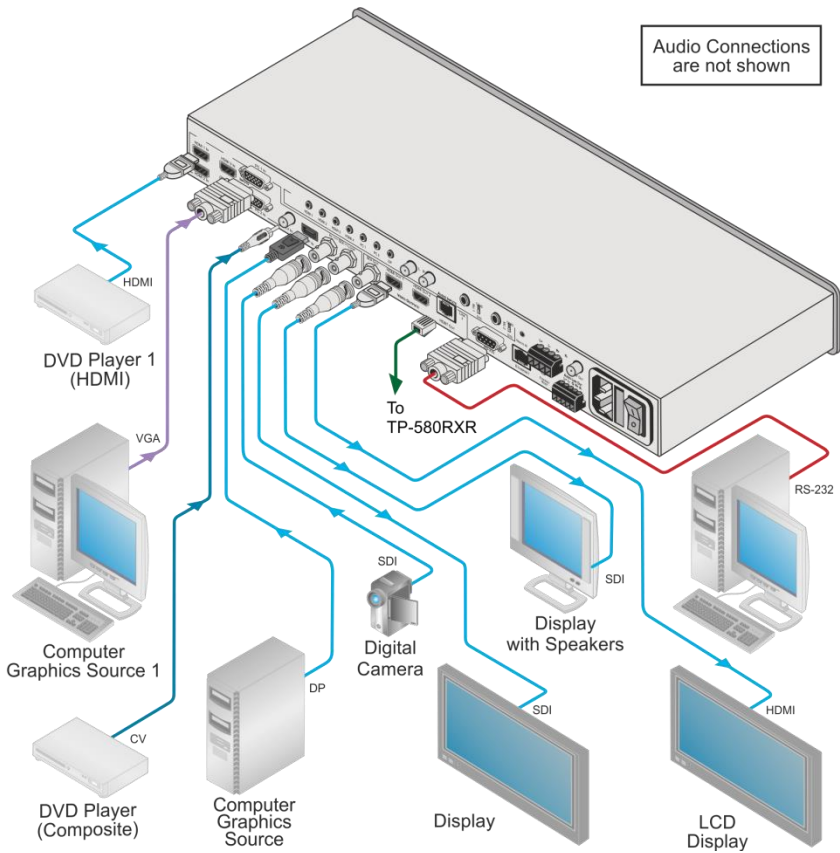

Figure 4: Connecting the VP-774AMP Presentation Switcher/Scaler

5.1 Wiring the RJ-45 Connectors

This section defines the TP pinout, using a **straight** pin-to-pin cable with RJ-45 connectors.

EIA /TIA 568B	
PIN	Wire Color
1	Orange / White
2	Orange
3	Green / White
4	Blue
5	Blue / White
6	Green
7	Brown / White
8	Brown

Figure 5: TP PINOUT

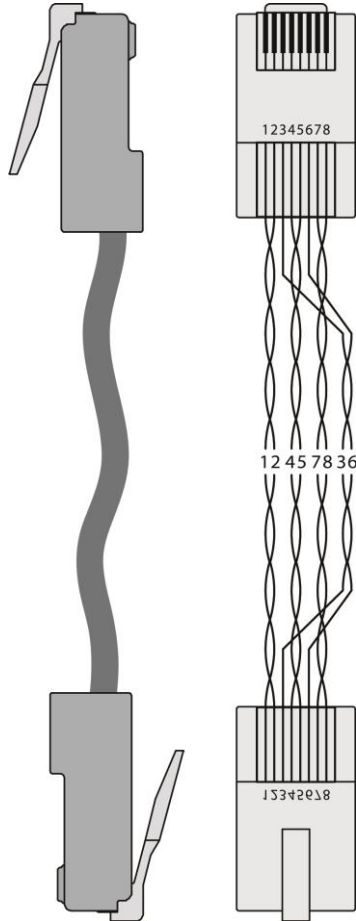

5.2 Connecting the Balanced Stereo Audio Output

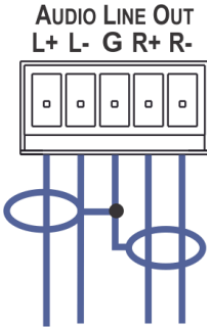

Figure 6: Connecting the Balanced Stereo Audio Output

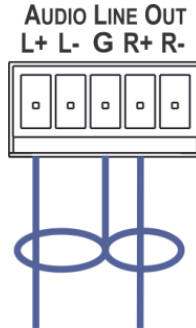

Figure 7: Connecting an Unbalanced Stereo Audio Acceptor to the Balanced Output

5.3 Microphone Pinout

This section defines the microphone 6mm jack pinout.

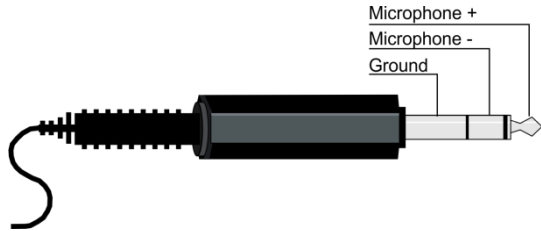

Figure 8: Microphone Pinout

5.4 Audio Input Pinout

This section defines the audio input 3.5mm jack pinout.

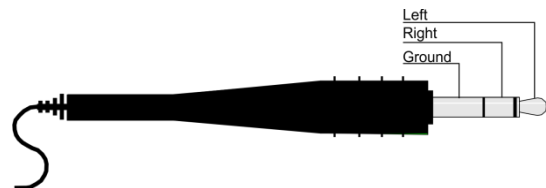

Figure 9: Audio Input Pinout

6 The OSD Menu

The **VP-774AMP** OSD menu lets you set the operation parameters for the:

- Main Window Control
- PIP Window Control
- Entire System Control

The nature of the operation setup appears in the OSD title, as shown in the example in [Section 6.1](#):

- The title line shows the control mode (Main, PIP or Entire system)
- Level 1 lists the main menu items
- Level 2 includes the second hierarchy level, below level 1
- Level 3 includes the third hierarchy level, below level 2
- Function, is the selectable parameter or numerical value and can appear either under level 2 or 3

6.1 OSD Menu Operation Example

In the example illustrated below, the Master Connection is set to HDMI2 (see [Section 6.7](#)).

The table below shows function 632 (from the Protocol in [Section 13.2](#)):

- 6 in the hundreds, represents “Scale” which is the 6th menu item in the main menu list
- 3 in the tens, represents “Output” which is 3rd in the Scale menu
- 2 in the units, represents “Master Connection” which is second in the Output menu

Level 1	Level 2	Level 3	Level 4 (Function)	Range	Function
Scale (6)	Output (3)	Master Connection (2)	HDMI1	0	632
			HDMI2	1	
			HDBT	2	
			SDI	3	

The subtitle, below the title line shows the current level accessed (Scale in this example)

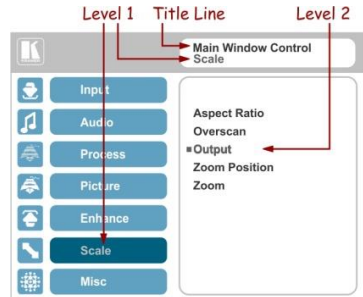

After selecting Output (which is the second Level), it appears in the subtitle

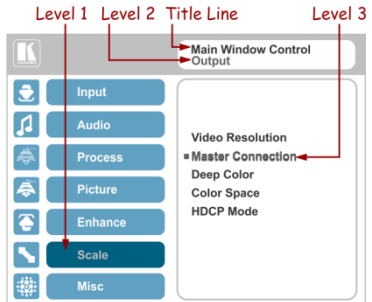

Once Master Connection is selected, the Title changes to "Entire System Control" indicating that the selection will affect the entire system. The subtitle shows the current, Level 3, selection and the menu list shows the function (HDMI2)

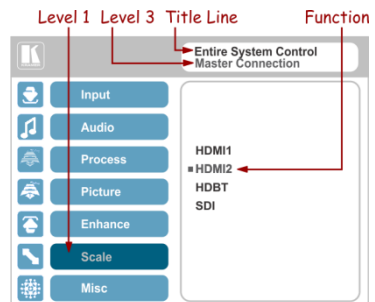

If the display layout includes a PiP window, you can set the OSD menu to control the main source window and the PiP window separately (by defining Window Control, see [Section 6.8](#)).

General characteristics which apply to the entire system (for example, setting the volume) are changed without needing to shift control (the title line will state: Entire System Control).

Note that:

- A selected parameter that turns gray becomes valid immediately. You can press Enter at this point to save these parameter changes to the memory immediately (the screen will display “Saving Data” for a split second).
- In any case, exiting the menu saves the parameter to the memory
- Data is saved per window and per input (to a dedicated input + window memory), as applicable

The control buttons let you control the **VP-774AMP** via the OSD menu. Press the:

- MENU (or <) button to enter the menu, exit the menu, and when in the OSD menu, move to the previous level and change menu settings in the OSD screen.

Changes are immediate

The default timeout is set to 30 seconds and can be changed (see [Section 6.8](#))

- ENTER (or >) button to access sub-menu items
- Arrow buttons to move through the OSD menu
- Up or down arrows to change settings



Note that when exiting the menu, all the changes are automatically saved to the non-volatile memory.

The default OSD timeout for auto exit is set to 30 seconds and can be changed (see [Section 6.8](#)).

6.1.1 OSD Control Icons

The following three icons: **M**, **P**, and **E** are included to indicate when functionality applies to the Main window, the PiP Window or the entire system:

- **M** for Main Window Control
- **P** for PiP window Control
- **E** for Entire System Control

6.2 The Input Menu

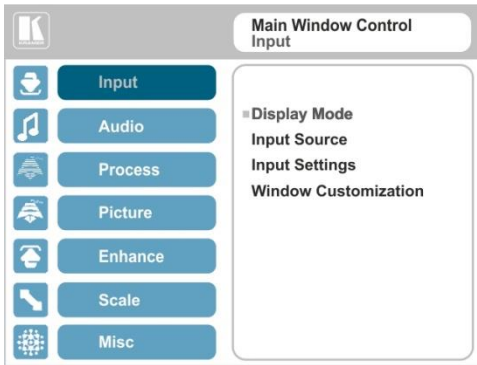











Figure 10: Input Menu

Setting	Function
Display Mode	<p>Select the display mode (see Figure 11):</p> <p>Single Window – single window mode operation with one channel displayed </p> <p>Picture in Picture (PiP) – dual window mode operation, a smaller window superimposed over a full screen image (see Section 7.2) </p> <p>Picture + Picture (PoP) – dual window mode operation, both images appear side-by-side and the aspect ratios of both images are maintained (see Section 7.2) </p> <p>Split (SbS) – dual window mode operation, both images are placed side-by-side with the same height (see Section 7.2) </p> <p>When selecting the dual window mode, set the Main window or the PiP window parameters via Misc -> OSD -> Window Control (see Section 6.8)</p> <p>Note that while browsing the OSD menu in the dual window mode, press of the PiP button to instantly toggle the window control (between Main and PiP)</p> <p>Customized – customized image size </p> <p> Note that any change in the output resolution may cause disproportion or even cancel the window customization.</p>
Input Source	<p>Select the input source: HDMI1, HDMI2, HDMI3, HDMI4, PC1, PC2, CV, DP or SDI </p> <p> Note that any change in the input source may cancel the freeze and blank settings.</p>

Setting	Function
Input Settings	<p>Set the:</p> <p>H Image Shift – to set the horizontal position of the image within the window </p> <p>Volatile parameter</p> <p>V Image Shift – to set the vertical position of the image within the window </p> <p>Volatile parameter</p> <p>Auto Positioning – to search the input image during the tuning process and automatically position it on the output window in a perfect fit. Set to Off to disable auto positioning Set to Normal Scan to perform a normal range image search Set to Wide Scan to perform a wide range image search </p> <p>In the Normal/Wide Scan option the machine automatically adjusts the PC (PC 1 and PC 2) and DP input video resolutions. For the other inputs, the machine automatically adjusts all the input video resolutions except for HD/SD (CEA 861 standard) video resolutions</p> <p>HDCP Mode – to select the HDCP option for each HDMI input: either ON (the default) or OFF </p> <p>Setting HDCP mode to Off on the HDMI input allows the source to transmit a non-HDCP signal if required (for example, when working with a Mac computer).</p> <p>EDID Select – to select the native resolution on each input (HDMI, DP and VGA inputs) to be read by the video source connected to that input: 1024x768@60, 1280x800@60, 1280x1024@60, 1366x768@60, 1440x900@60, 1400x1050@60, 1600x900@60, 1600x1200@60, 1680x1050@60, 1920x1200@60RB, 720p50, 720p60, 1080p50, 1080p60, 2k50 or 2k60 </p> <p>Note that for the HDMI and DP inputs, you can either select the color depth to be 8bpp or 12bpp after selecting the native resolution and after selecting the color depth you can select either single or multiple modeline. Native as Multiple Modelines – generating a group of resolutions in the detailed timing, including the native resolution), or Native as Single Modeline – generating only the native resolution in the detailed timing</p> <p> Note that when the EDID is set on the inputs, the changes are per input and immediate.</p> <p>Color Space – to select the color space for the PC and HDMI inputs: RGB, YPbPr or Follow Input Note that if the machine is set to the dual display mode, and both the Main and PiP windows display the same input, you need to set the same input color space value for both windows</p> <p> In case of digital video, Follow Input follows the actual color space; in case of analog video it follows only the input resolution: HD/SD resolutions are considered to be YUV color space and other resolutions will be considered as RGB color space.</p>

Setting	Function
Input Settings (continued)	<p>Image Shift Mode – to get the best image positioning possible. Set to Auto to automatically get the best possible image positioning automatically; set to Semi-auto to store the best image possible until the video resolution of the selected input is changed (in which case the setting bounces to Auto); set to Customize to keep the settings even if the video resolution of the selected input is changed</p> <p>Note that a video resolution change, when in the Customized mode, may possibly result in an image positioning that is inaccurate with regards to the new video resolution and may need to be set once again</p>
Window Customization	<p>Select the position and the size of the selected window: H Position, H Width, V Position and V Height (see Section 6.2.1.1 and Section 6.2.1.2) </p> <p>The value range is dynamic. The FW prevents windows from exceeding the boundaries or over-sizing. The position and size of the windows are saved to the system.</p> <p>The size and position of the customized window (Main or PiP) remain valid even when toggling the PIP button (front panel, remote control transmitter or protocol command).</p> <p>The customized setup is cancelled only by explicitly selecting a preset Display Mode (see first item in this table) or if a new customized setup is created.</p> <p>Use the front panel + and – buttons, IR remote control transmitter or Web page to set the position and height of the Main and/or PiP windows</p> <p> The PiP window maximum horizontal active image area is 1600 pixels</p>

The display mode setup, shown in [Figure 11](#), is part of the entire system control and the selected Single Window also shows the current aspect ratio (Best Fit):



Figure 11: Select the Display Mode

6.2.1 Window Customization

Window customization lets you change the size and position of a selected window. Make sure that you have control over the window that requires customization (Main Window Control or PiP Window Control). If not, select it via the OSD item in the Miscellaneous menu, see [Section 6.8](#).

In the following examples, PiP Window Control is selected, but the same procedure applies to Main Window Control.



Note that you can also customize the window size and position via the “Y” commands (see [Section 13.2](#)) or protocol 3000 (see [Section 13.4](#)).

6.2.1.1 Changing the Size of the Main and/or PiP Window

Use the H Width and V Height to change the size of the window using the + and – buttons on the front panel or remote control transmitter (as illustrated in [Figure 12](#)).

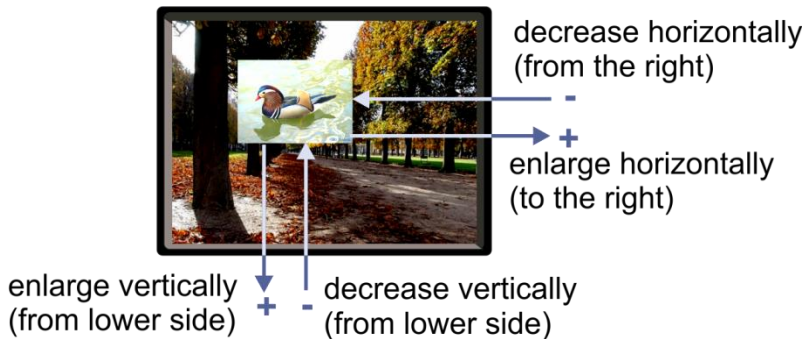

Figure 12: Changing the Size of the Window

To change the size of the window, do the following:

1. Check that window control is set as required (for example, PiP Window Control).
2. Select Window Customization (see [Figure 16](#)).
3. Select H width (an OSD slide bar appears) and press + to increase the width, or – to decrease the width, see [Figure 13](#).

The following example shows how to increase the width of the window

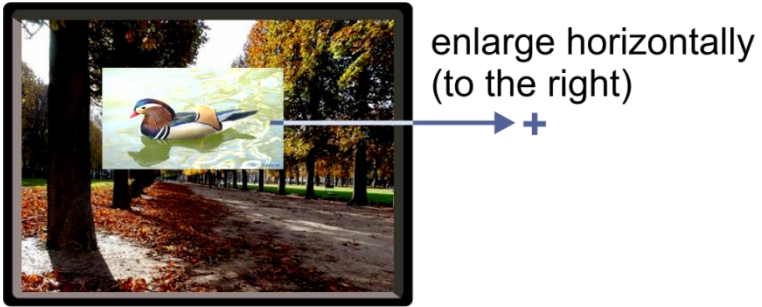

Figure 13: Increasing the Width

4. Select V Height (an OSD slide bar appears) and press + to increase the height, or – to decrease the height, see [Figure 14](#).

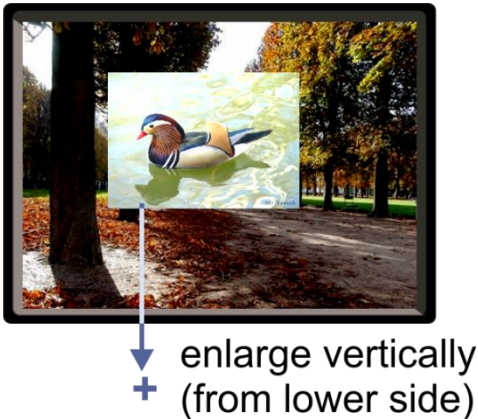

Figure 14: Increasing the Height

6.2.1.2 Moving the Position of the Main and/or PiP Window

Use the H Position and V Position items in the OSD to change the position of the window using the + and – buttons on the front panel or remote control transmitter (as illustrated in [Figure 15](#)).

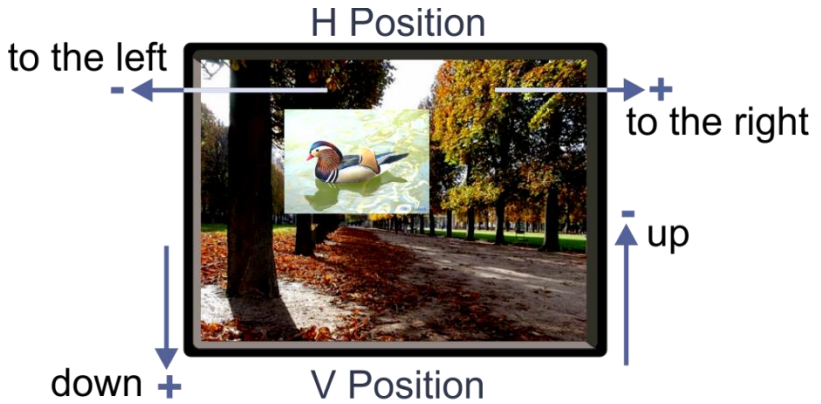

Figure 15: Positioning the Window

To move the position of the window, do the following:

1. Check that window control is set as required (for example, PiP Window Control).
2. Select Window Customization.

The following Window appears:

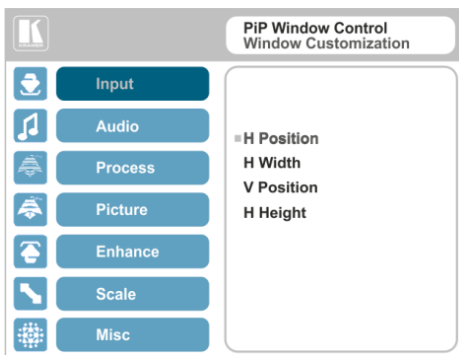

Figure 16: Window Customization

3. To move the picture to the right, select H Position.

An OSD slide bar appears:

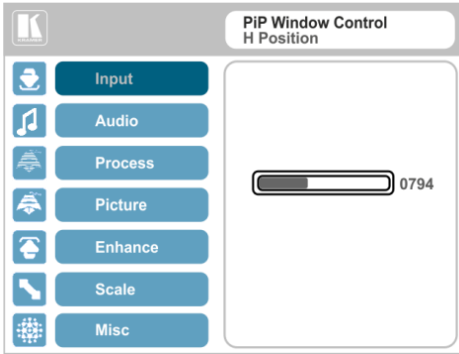

Figure 17: H-Position Slide Bar

4. Press the +/- buttons to move the PiP window horizontally. Use the V Position menu item in the same way to move the PiP vertically, see [Figure 18](#).

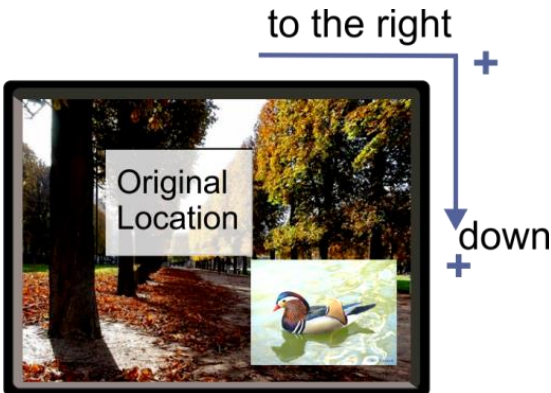

Figure 18: Moving the PiP Window



Note that the sequence in which you change the size and position of the window is insignificant, as long as you make sure that the resized image does not go beyond the window boundaries.

6.3 The Audio Menu

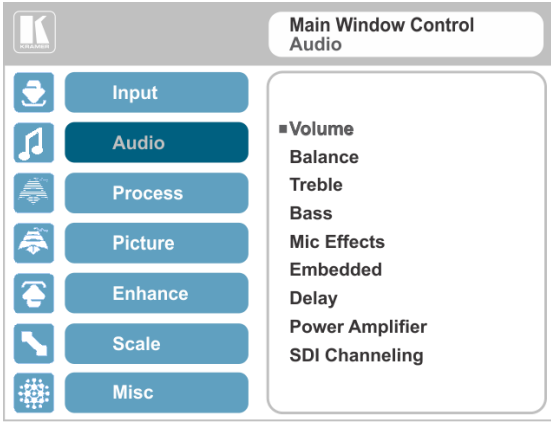











Figure 19: Audio Menu

Setting	Function
Volume	<p>Set the input/output volume level [dB], see Figure 20. Set the:</p> <p>Input Volume [dB] – to adjust the audio input level</p> <p>Output Volume [dB] – to adjust the audio output level</p> <p>The maximum output volume can be pre-limited via the Web pages (see Section 9.6.2). When setting the volume level, once the slider reaches the maximum defined by the pre-limiter, a “Volume is pre-limited” message appears on screen.</p> <p>The output audio level can also be set via the + and – buttons on the front panel buttons (when not in the OSD mode) and/or the IR remote control transmitter buttons (see Section 8.4).</p> <p>Note that when set to MUTE (see Section 6.8), changing the output level unmutes the audio signal.</p> <p>Mic1 Volume [dB] – to adjust the Microphone 1 audio level</p> <p>Mic2 Volume [dB] – to adjust the Microphone 2 audio level</p>
Balance	Set the balance [ratio]
Treble	Set the treble [dB]
Bass	Set the bass level [dB]
Mic Effects	<p>For Mic 1, set the:</p> <p>Mic1 Talkover Depth [%] – to determine the decrease of the audio level during microphone 1 takeover (press + to further decrease the talkover audio output level; press – to lessen the talkover output audio decrease level)</p> <p>Mic1 Talkover Trigger [dB] – to determine the microphone 1 threshold level that triggers the audio output-level decrease</p> <p>Mic1 Mix [dB] – set to 1 to enable the Talkover mode or set to any other value to decrease the Mic1 volume without changing the Line out and Mic2 volume levels.</p> <p>In the Mix mode, set the:</p> <p>Line Mix [dB] – to decrease of the line out volume level without changing the Mic 1 and Mic 2 volume levels</p>

Setting	Function
Mic Effects (continued)	<p>For Mic 2, set the:</p> <p>Mic2 Mix [dB] – set to 1 to enable the Talkover mode or set to any other value to decrease the Mic2 volume without changing the Line out and Mic1 volume levels.</p> <p>Mic2 Talkover Trigger [dB] – to determine the microphone 1 threshold level that triggers the audio output-level decrease </p> <p>Mic2 Talkover Depth [%] – to determine the decrease of the audio level during microphone 2 takeover (press + to further decrease the talkover audio output level; press – to lessen the talkover output audio decrease level) </p> <p>Both microphone inputs can be output along with the audio output in the Talkover (default) mode or the Mix mode, separately or together.</p> <p>In the Talkover mode (Mic Mix is set to 1), the audio output volume level decreases when the microphone is used and it returns back to its original set level when the microphone input is inactive.</p> <p>In the Mix mode, the microphone input is mixed with the audio output at a set level.</p> <p>For each microphone input you can set the Mic Talkover Depth, Mic Talkover Trigger and Mic Mix independently. You can also set the Line Mix separately.</p>
Embedded	<p>Set:</p> <p>Pass-through – to On to pass the digital audio input directly to the output without any processing or set to Off to process the digital audio input </p> <p> Note that this feature is disabled for the non-embedded audio inputs (PC and CV) In case the audio signal is encrypted or compressed set the Pass-through to On, although in some cases there may not be sufficient capacity to accurately transmit the audio.</p> <p>Analog Takeover – to On for the analog inputs of the HDMI and DP inputs to take over the embedded inputs; select Off to use the embedded inputs </p> <p>Analog takeover is available only if an unbalanced audio signal is connected (via 3.5mm connector). When set to On, the embedded audio is disabled as long as the 3.5mm cable is connected to the 3.5mm mini jack</p>
Delay	<p>Set:</p> <p>Lip Sync delay value [msec] </p> <p>Mic1 Delay value [msec] </p> <p>Mic2 Delay value [msec] </p>
Power Amplifier	<p>Set the power amplifier (SPKR OUT) level to Off or to levels 1 to 4 </p> <p>This submenu item is specific for the power amplifier on top of the general volume level</p>
SDI Channeling	<p>Set the SDI channeling for groups A, B, C and D and connect the active and the bypassed channels (see Section 6.3.1)</p> <p>By default, groups A and B are connected and groups C and D are disconnected</p> <p>Set the SDI channeling for groups A, B, C and D to Activate CH1, Activate CH2 or Bypass. If other groups are set to Activate or Bypass, the remaining groups are read as None</p> <p>Set Bypassed channels to Unmute or Mute (see Section 6.3.1.1)</p>

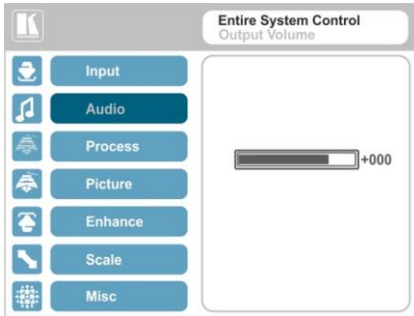

Figure 20: Set the Output Volume Level

6.3.1 SDI Channeling

SDI channeling includes four groups with two stereo channels each. Two of the groups are always connected and the other two disconnected. You can select (via the OSD) one of the eight SDI embedded stereo audio channels, together with three bypassed channels, to be routed to the input of a connected machine with SDI audio channels (for example, the Kramer **6810HDXL** SDI/HD-SDI/3G Audio Embedder/De-embedder, or the Kramer **6809HD** HD/SD-SDI AES Embedder).



Within the two connected groups, one channel can be activated and the remaining three channels are bypassed. The acceptor device will input the channels as follows: the active channel is input as Group A, CH1; the bypassed channel in the same group is input as Group A, CH2; the two remaining bypassed channels are input as Group B CH1 and CH2.

In the example illustrated in [Figure 21](#), channels C and D are disconnected and channels A and B are connected (CH1 and CH2 in group A are bypassed, CH1 in group B is bypassed and CH2 in group B is active).

These channels are input to the Kramer **6810HDXL**, processed and output to an audio acceptor:

- The group B active CH2 signal is input as Group A, CH1
- The group B bypassed CH1 signal is input as Group A CH2
- The group A bypassed CH1 signal is input as Group B CH1
- The Group A bypassed CH2 signal is input as Group B CH2

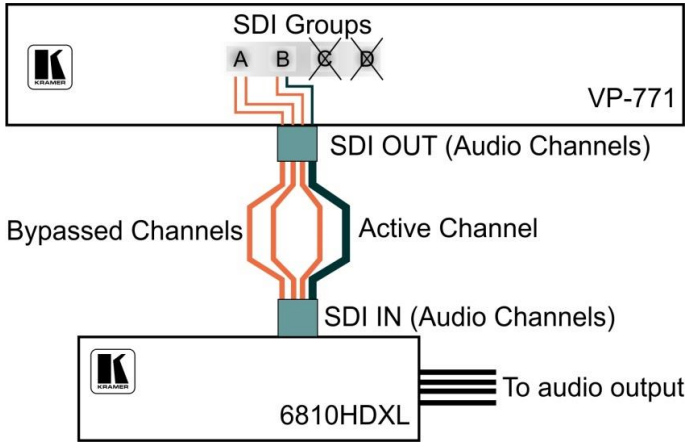

Figure 21: SDI Channelling Example

The active channel and bypassed channels are selected via the OSD menu.

[Figure 22](#) shows the SDI Channelling menu:

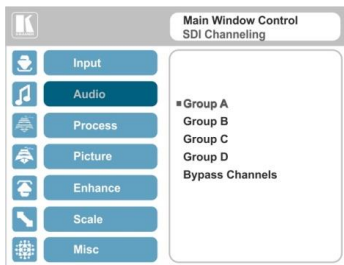

Figure 22: The SDI Channelling Menu

In the OSD setup that is illustrated in [Figure 23](#), CH 2 in group B (active), CH1 in group B as well as CH 1 and CH2 in group A (bypassed) are routed via the **VP-774AMP** SDI output to the input of **6810HDXL**; groups C and D are disconnected and therefore read as None (see example in [Figure 21](#)).

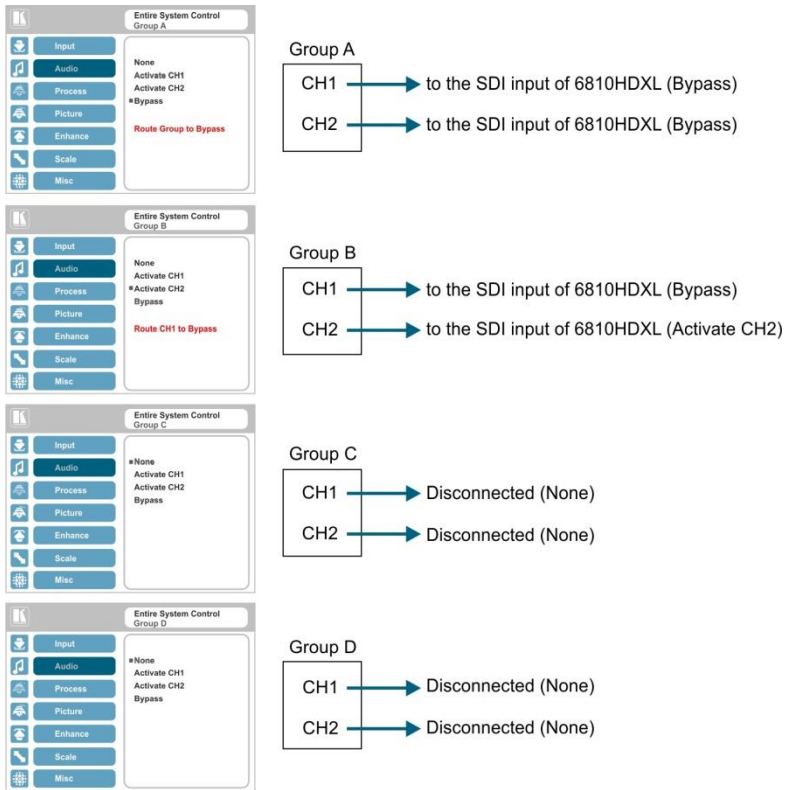

Figure 23: SDI Channeling Example

If a different channel within the connected groups is activated, the remaining three channels will be automatically routed to bypass.

If a channel in a disconnected group is activated, the system will automatically rearrange the groups and channel assignments to keep two groups connected and two others disconnected.

6.3.1.1 Bypassed Channels

Select Bypass channels to set the bypassed channels to mute to cutoff the bypassed audio channels or to Unmute to let them pass through:

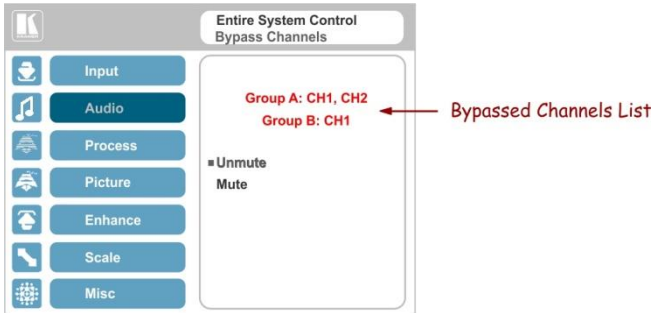

Figure 24: SDI bypassed Channels Menu

The Bypass Channels menu also lists the selected bypassed channels in the enabled groups.

6.4 The Process Menu



The Process menu functions are available for interlaced video processing only and not for progressive scan.

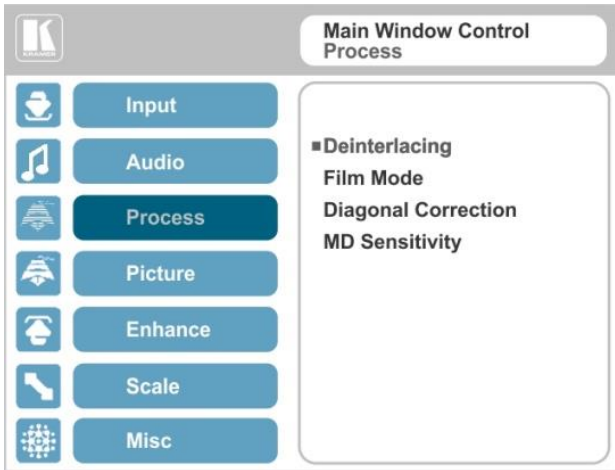

Figure 25: Process Menu

Setting	Function
Deinterlacing	<p>Set the deinterlacing method to:</p> <p>Line Doubler – reduces the flicker and improves the quality of the image to some extent M/P</p> <p>Line doubler takes an interlaced scan, doubles the lines. The additional lines provide a better quality image and a brighter output</p> <p>Motion adaptive – to produce a brighter smoother and higher resolution image M/P</p> <p>Set the deinterlacing (per window) sync to:</p> <p>Current Field – for a long delay M/P</p> <p>Older Field – for a short delay M/P</p> <p>When selecting Older Field, diagonal correction is disabled</p>
Film Mode	<p>Set to:</p> <p>Off – for no pull-down M/P</p> <p>Follow Input – to automatically identify the required pull-down (2:2 or 3:2 pull-down) M/P</p> <p>24PsF – to force 24PsF pull-down M/P</p>
Diagonal Correction	<p>Set the level of diagonal interpolation from 0 to 3.</p> <p>When set to the lower level, the diagonal image does not appear smooth M/P</p>
MD Sensitivity	<p>Set (from Level 1 to Level 5) M/P</p> <p>Select the motion detection sensitivity for filtering of interlaced images. Set a high value for video where there is generally a large amount of motion, or a low value for little motion</p>

6.5 The Picture Menu

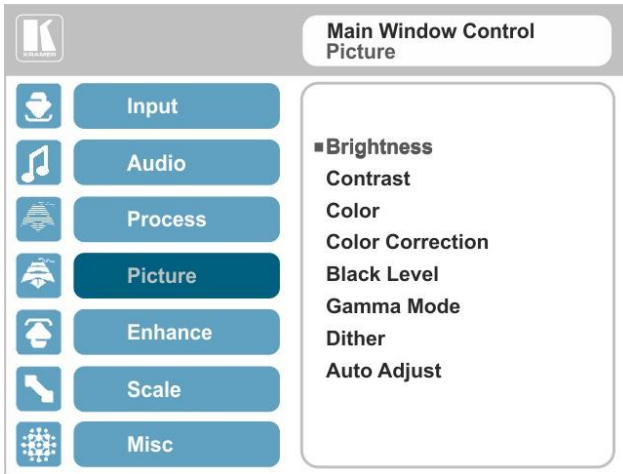

Figure 26: Picture Menu

Setting	Function
Brightness	Set the brightness level M/P
Contrast	Set the contrast level M/P
Color	Set the color level M/P
Color Correction	Set the blue, green and flesh color levels from 0 to 4 M/P
Black Level	Set the black level M/P
Gamma Mode	Set the gamma correction factor to Off, 0.4, 0.8, 1.2, 1.6, 2.0, 2.4 or 2.8 E The higher the value, the darker the image
Dither	Set the error diffusion E : Mode0: Disable error diffusion Mode1: In-frame 8:6 conversion Mode2: Intra-frame 8:6 conversion Mode3: In-frame 10:8 conversion Mode4: Intra-frame 10:8 conversion Mode5: In-frame 12:10 conversion Mode6: Intra-frame 12:10 conversion
Auto Adjust	Set the image color (back to its default values) and position per window (centers it correctly on the screen) M/P See Auto Positioning menu item in Section 6.2 Note that Auto Adjust is disabled when in the Freeze state

6.6 The Enhance Menu

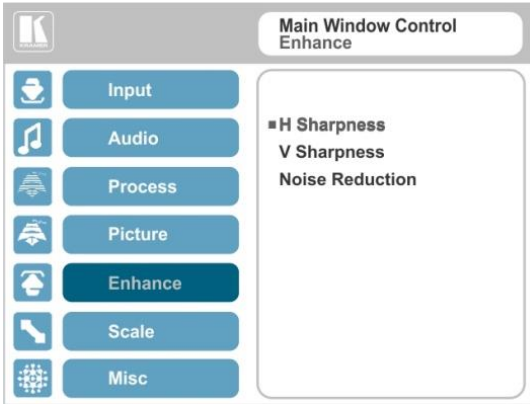

Figure 27: Enhance Menu





Setting	Function
H Sharpness	Select the horizontal sharpness level
V Sharpness	Select the vertical sharpness level
Noise Reduction	<p>Set the input noise reduction levels:</p> <p>Mosquito NR – the higher the level, the stronger the filtering of the image </p> <p>Combing NR – set to improve the quality of the subtitles </p> <p>Temporal NR – the higher the level, the stronger the filtering of the image. Useful when the noise is visible to the eye </p> <p>Block NR – as the level is set higher, the block noise disappears and the image appears softer </p> <p> Input noise reduction (except for Temporal NR) is enabled for interlaced video processing only and is inactive in the progressive scan.</p>

6.7 The Scale Menu



Figure 28: Scale Menu

Setting	Function
Aspect Ratio	<p>Set (see Section 6.7.1) to:</p> <p>Follow Input – If the input resolution \leq output resolution, display with a blank border.</p> <p>input > output is denied and the aspect ratio automatically changes to Follow Output M</p> <p>Follow Output – If the input resolution \leq output resolution, scale up the picture. If the input resolution \geq output resolution, scale down the picture M</p> <p>Best Fit – the best possible compromise between the input and the output aspect ratios M</p> <p>Letterbox – to compress the top and bottom edges of the input signal, but fill the width of the screen M</p> <p>Applies to the Single Window display mode only</p>
Overscan	Set the overscan (per window) to Off, 5% or 10% M/P
Output	<p>Set the:</p> <p>Output Resolution – to Native, 640x480@60, 640x480@75, 800x600@50, 800x600@60, 800x600@75, 1024x768@50, 1024x768@60, 1024x768@75, 1280x768@50, 1280x768@60, 1280x800@60, 1280x1024@50, 1280x1024@60, 1280x1024@75, 1360x768@60, 1366x768@50, 1366x768@60, 1400x1050@50, 1400x1050@60, 1600x900@60, 1600x1200@50, 1600x1200@60, 1680x1050@60, 1920x1200@60, 480i60, 480p60, 576i50, 576p50, 720p50, 720p59.94, 720p60, 1080p23.976, 1080p24, 1080p25, 1080p29.97, 1080p30, 1080p50, 1080p59.94, 1080p60, 2k50 or 2k60 E</p> <p>i Note that any change in the output resolution may cancel the zoom setting and window customization.</p> <p>Master Connection – to HDMI1, HDMI2, HDBT or SDI to determine the machine's behavior (see Section 6.7.2) E</p> <p>If the native resolution is not supported by the selected Master Connection, the system searches for the best supported resolution. If the search fails (for example, if the master connection is disconnected or EDID is unreadable), the resolution will default to XGA.</p>

Setting	Function
Output (continued)	<p>Deep Color – to Off (the default) for 8bit color depth or to Follow Output for applying deep color automatically on the HDMI output if supported by the display.</p> <p>Note that Follow Output sets the Deep Color of the HDMI and the HDBT outputs independently, according to the screen connected to each output</p>  A change in the Deep Color setting will take effect after there is a hot plug on the HDMI/HDBaseT output or if the user selects a new output resolution. <p>Color Space – to RGB, YPbPr422 or YPbPr444 (does not apply to the SDI output)</p> <p>HDCP Mode – define the HDMI out HDCP activation policy. Set to: Follow Input: to activate the HDCP on all HDMI outputs in the case that the video on the Main or PiP window is HDCP encrypted. Follow Output (This option is recommended when the HDMI output is connected to a splitter/switcher): to activate the HDCP per output according to the setting of the HDMI acceptor to which it is connected; that is, if the HDMI acceptor is not HDCP compliant, the VP-774AMP always outputs without HDCP and vice versa. Note that the VP-774AMP will output a green screen if the output acceptor to which it is connected is not HDCP compliant, in the case that the video on the Main or PiP window is HDCP encrypted.</p>
Zoom Position	<p>Set H Position and V Position, the horizontal and vertical zoom positions respectively, to zoom into certain areas of the image </p> <p>Lets you "move" the zoom area (same as scanning an area with a magnifying glass)</p>
Zoom	<p>Set the zoom </p> <p>Zooms into the center of the display. When zooming in the Freeze state, in case the input resolution is larger than the output resolution, the image may be cut-off or change its position. This can be fixed via Zoom Position (above).</p>
	Note that any change in the output resolution will cancel the zoom setting.

6.7.1 Selecting the Correct Aspect Ratio

You can configure the aspect ratio of any output image to fit your application. The **VP-774AMP** offers four different aspect ratio settings: Follow Input, Follow Output, Best Fit and Letterbox. Here is how each of these settings works.

FOLLOW INPUT – The aspect ratio and resolution of the input video or graphics signal are both preserved (no scaling). For example, a composite video image with a 4:3 aspect ratio will appear with the same aspect ratio on a 1080p (16:9) output image, surrounded by black bars



FOLLOW OUTPUT – The aspect ratio and resolution of the input signal is re-sized to precisely match the aspect ratio and resolution of the **VP-774AMP** output signal. This may result in some distortion to the input signal images



BEST FIT – This setting re-sizes the video or graphics input signal to “best fit” the output resolution while maintaining the aspect ratio of the input signal. For example, a composite video signal (4:3 aspect ratio) will “best fit” to the top and bottom of a widescreen output image, resulting in black pillars on either side.



LETTERBOX – This setting compresses the top and bottom edges of the input signal, but fills the width of the screen. For example, to preserve a widescreen film image on a 4:3 display. When not using a 4:3 monitor, this mode is identical to Best Fit



6.7.2 Master Connection Settings

The Master Connection (HDMI1, HDMI2, HDBT or SDI) is usually set to the main output display so that the optimal resolution for that display can be obtained.

By setting the output resolution to Native, the **VP-774AMP** is triggered to read the EDID of the main display and change the output resolution value according to the native resolution of the display.

Note that when the output resolution is set to Native:

- Selecting SDI as the Master Connection results in an output resolution of 720p @60
- If SDI is selected as the Master Connection, hot plugging the HDMI/HDBT output will not change the output resolution
- If HDMI/HDBT is selected as the Master Connection, and a new display is connected to the Master Connection output (hot plug), the **VP-774AMP** automatically reads the EDID of that display and updates the output resolution accordingly
- If it is not supported by the selected Master Connection, the system searches for the best supported resolution. If the search fails (for example, if the master connection is disconnected or EDID is unreadable), the resolution will default to XGA

6.8 The Miscellaneous Menu

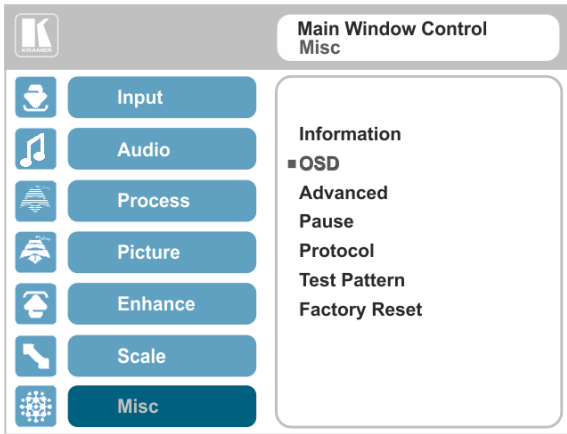















Figure 29: Misc Menu

Setting	Function
Information	<p>Displays the selected input, input resolution and frequency, the output resolution, firmware versions and IP Address M/P</p> <p>If the selected output is the native output resolution, it will be displayed under "Native Output" (the master connection will also appear, before "Native Output") ; in case of an explicit output resolution the title will be "Output:"</p> <p>If the input video is encrypted, an HDCP icon appears next to the input information</p>
OSD	<p>Set:</p> <p>Window Control – to Main Window Control to set the OSD menu to control the Main window (letting you select the input and other parameters for the main window) or to PiP Window Control to control the PiP window (letting you select the input and other parameters for the PiP window) [E]</p> <p>While browsing the OSD menu in the dual window mode, the window control can be toggled instantly with a long press of the PiP button on the front panel and a short press of the PiP button on the IR remote controller.</p> <p>Note that you can select the window control only when in the dual window mode</p> <p>H Position – to set the horizontal position of the OSD [E]</p> <p>V Position – to set the vertical position of the OSD [E]</p> <p>Transparency – to set the transparency to On or Off [E]</p> <p>Transparency Gain – to set the transparency level (once set to transparent) [E]</p> <p>Transparency Bias – to set the transparency level [E]</p> <p>Blink – to On for the selected item in the OSD to blink, or Off [E]</p> <p>Blink Period – to determine the blinking rate [E]</p> <p>Timeout – to 30 seconds before OSD timeout, 60 seconds before OSD timeout or OFF (Off means that that the OSD appears continuously) [E]</p>
Advanced	<p>Set:</p> <p>V Keystone – to set the vertical keystone level [E]</p> <p>Useful If the projector is located at an angle above or below the screen. In the OSD menu the value range shows -80 to 80. For interlaced inputs, this feature is disabled</p>

Setting	Function
Advanced (continued)	<p>Auto Sync Off – to turn the auto sync On/Off. When ON, 2 minutes after not detecting a valid video signal on the selected input (or both inputs in the dual window mode), the unit will disable the syncs and the audio on all the outputs, until a valid input is again detected or any keypad button is pressed to activate the machine (once restored, the buttons return to their normal function) </p> <p> When using the VP-774AMP for audio only, we recommend that you turn this feature off</p> <p>Luma Keying – to turn the keying on the PiP window ON or OFF (see Section 6.8.1) </p> <p>Alert System – to set the Alert system On or Off (see Section 6.8.2) </p> <p>No Signal – to set the color of the windows if no signal is detected. Select Gray, Blue or Black </p> <p>If gray or blue is selected, the Main window color is light while PiP has a darker shade. When black is selected, both windows appear black</p> <p>Auto Switching – to set auto switching to Off, Scan mode or Last Connected mode separately for the Main window and the PiP window. Set to Scan to scan through the inputs in search of a valid input signal. Set to Last Connected to immediately switch to the latest valid input signal connected (for HDMI and DP inputs only). Note that in case the last connected valid input signal is disconnected, the VP-774AMP will switch to the previous last-connected valid-input signal, and then to the input before that and so on until the last disconnected inputs, and then a “No Signal” screen will appear Set to Off to disable scanning </p> <p>Note that by default the highest priority input on the list is HDMI1 and the lowest is DP (according to the order of the input front panel buttons). In the scan mode you can select which of the inputs will be included in the scan and also change the order of the scanned inputs (the priority list), via the Web pages only, see Section 9.1.3</p>
Pause	<p>Set:</p> <p>Freeze – to ON to freeze the window (freezing the main window will also mute the audio output) </p> <p>Blank – to ON to display a blank window (blanking the main window will also mute the audio output) </p> <p> Note that any change in the input source may cancel the freeze and blank settings.</p> <p>Mute – to ON to mute the audio output </p> <p>A mute/unmute icon appears on screen according to the state selected. Note that MUTE is disabled once changing the volume level</p> <p>Disable Outputs – to turn the sync and audio On/Off. When ON, the unit will disable the syncs and mute the audio output until any keypad button is pressed </p> <p>Once Disable Outputs is selected, a countdown appears, letting you cancel the process and revert to the previous state</p>
Protocol	<p>Set the communication protocol to P3K or Legacy (see Section 13) </p> <p> When setting the Protocol to Legacy, some PC applications (for example, K-Upload) as well as the Web pages may not function properly.</p>

Setting	Function
Test Pattern	Set the Test pattern to Slide Bar (non-HDCP), Color Bar (HDCP) or Off. Each test pattern includes a sinusoid audio signal We recommend that you set the Display Mode to Single Window (see Section 6.2) and set the Output Resolution to 1080p (see Section 6.7). Note that the Color Bar test pattern changes the OSD menu coloring and the following message appears on the display: "Ignore OSD Coloring"
Factory Reset	Reset to factory default values (see Section 12.1)  Once Factory Reset is selected, a countdown appears, letting you cancel the process and revert to the previous state Note that full Factory Reset includes Ethernet reset as well

6.8.1 The Luma Keying Feature

The luma keying feature is an easy-to-use method of compositing two video sources into a single image. By setting up a “key” image or clip on a black background, it can be merged – or overlaid – onto the primary video. The key image is transparent in the areas of its dark background, resulting in a picture which looks as if the key image is cut out and pasted over the primary image. This useful function of combining images from two different sources is suitable for many applications, such as sub-titling, labeling, advertising or logo insertion.

To apply the luma keying feature, first set the PiP window to the desired size and location and then turn luma keying On. The PiP image will show without its background.

The lower the luminance in the PiP window, the more transparent it becomes, thus letting the main window image show. The higher the luminance, the less transparent it becomes, not letting the main window show through. To use this feature it is recommended to set the PiP image as follows: use low-luminance colors for the background (the key image portion) and high-luminance colors for the logo.



For certain displays, the screen may flicker once for about a second after activating or changing the luma keying setting.

We recommend that you activate luma keying after completing the setup.

When the luma keying feature is On, any change in the setup (either by the user or by resetting due to a setup change) may cause the screen to flicker once. The luma keying will recover automatically after resetting.

6.8.2 The Emergency Alert System

The Emergency Alert System (EAS) is a unique, versatile feature for immediate text overlaying, with flexible options such as the inclusion of an audio alert siren and the choice of displaying an emergency notification via either a text crawler or a text window.

The EAS provides the ability to have a site-wide notification immediately displayed when an emergency situation develops that could affect the health and welfare of the people attending the site, whether that site is an educational facility, a corporate site, a stadium or any other location where large groups of people come together. Messages can include specifics about weather (tornadoes, hurricanes, high winds, flooding, storms and so on), Amber and Silver alerts, safety and security, and also general advisories.

Emergency alert messages are composed and transmitted using the Common Alert Protocol (CAP). CAP is an XML-based application that allows a warning message to be consistently disseminated simultaneously over many warning systems to many proprietary applications and devices. By using XML, messages can be composed, transmitted, and received across a broad range of proprietary AV and other devices.

Generally, CAP format alerts can also trigger secondary functions, such as alert tones, horns, buzzers, and sirens. They can be used to switch on AV equipment to display alerts. The system also complies with the Emergency Alert System (EAS) standard, an official, national warning system in the United States, which works in coordination with the Federal Emergency Management Agency (FEMA) and a number of US national emergency agencies.



For more details on CAP, go to <https://www.oasis-open.org/committees/download.php/6334/oasis-200402-cap-core-1.0.pdf>.

The **VP-774AMP** intercepts XML files over the Ethernet in the CAP format via the dedicated EAS port from the alert generator server (for example, a FEMA server or a proprietary CAP message generation application) for immediate alert message triggering.

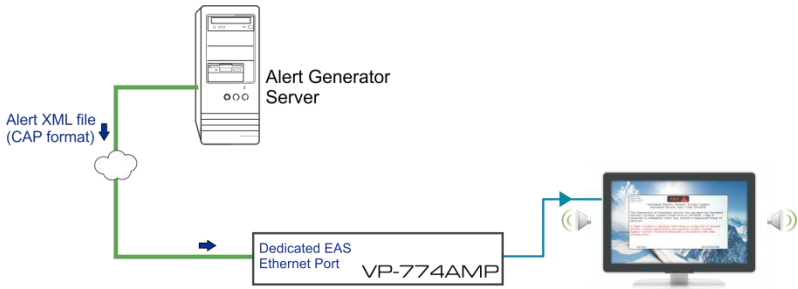

Figure 30: XML File Transfer

The position of the displayed CAP message depends on the severity of the alert. Noticeable messages with “Extreme” and “Severe” headers will appear on the screen and cover up any other content together with an audio alert siren (in case of an Extreme level alert). Messages with lower levels of severity will appear as a text crawler along the bottom of the image. When an alert is activated, the system (via P3K) outputs messages according to the activation mode type (see [Section 13.4](#)).



Figure 31: Emergency Alert System Display

The Expiration Date field of the CAP XML file determines when the message will expire. Note that you can remove the message sooner by pressing/clicking any of the buttons on the **VP-774AMP** (front panel or remote control buttons, as well as via the Web page or protocol commands).

To setup and activate the alert system on the **VP-774AMP**:

1. Set the dedicated EAS Ethernet connection port type and port number through which the **VP-774AMP** will be listening, as a client, to intercept alerts.
By default, the dedicated EAS port settings are TCP, 5005. To change these setting see the “Emergency Alert Configuration” in the table in [Section 13.4](#).
2. Make sure that the **VP-774AMP** is connected to Ethernet.
3. Make sure that Alert System in the Miscellaneous menu is set to On (see [Section 6.8](#)).

The **VP-774AMP** is now ready to receive any alert and display it.

Note that you can use the Emergency Alert System Web page to connect to an EAS server and create a local command (see [Section 9.8](#)).

6.8.2.1 EAS Requirements

The following table specifies the EAS requirements:

Text Length Definitions	
Attribute Name	Max Size
Status	20
Certainty	20
Urgency	20
Severity	20
Event	45
Headline	45
Description	240
Instruction	240
Sender	30
Sent	30
Max 30 contiguous chars per word	
Output Resolution	
The output resolution needs to be at least 1280x768	

7 The Display Modes

The **VP-774AMP** can function in the single window display mode (the factory default setup) or the dual window display mode.

7.1 The Single Window Display Mode

The single window mode shows one window on the screen. The window size can be customized, and its parameters modified via the OSD menu.

7.1.1 Activating the Single Window Mode

Set the **VP-774AMP** to the single window display mode in any of the following ways:

- Press and hold (for 3 seconds) the illuminated front panel PIP button until the button no longer illuminates
- Access the OSD menu, select INPUT>Display Mode, and then choose Single Window
- Access the Web pages (see [Section 8.3](#))
- Press the PIP window on the remote control transmitter (see [Section 8.4](#))

7.2 The Dual Window Display Mode

The **VP-774AMP** dual window mode feature lets you show two images on one screen: the main window and the PiP window. For example, you can show a live video window on top of a graphic background, or show two images on screen of the same input channel. The PiP window appears even if no input signals are connected. In this case the PiP window appears in dark gray and the main window appears in light gray.

The dual window mode appears in the following preset PiP configurations:

Picture-in-Picture, with a smaller PiP window superimposed over a full main window image



Picture + Picture, where both images appear side-by-side and the aspect ratios of both images are maintained



Split, where both images are placed side-by-side with the same height



The window customization feature (see [Section 6.2](#)) lets you customize the dual window mode layout (main window and PiP window) to any size and position.



You can superimpose any input type over any or the same input.

If the HDMI signal is HDCP protected, it can appear on HDMI and HDBT outputs that are connected to supported HDCP compliant displays. However, it cannot appear on a display that is not HDCP compliant and will show a green screen instead.

7.2.1 Activating the Dual Window Mode

You can activate the dual window mode (indicated by an illuminated PiP front panel button) in any of the following ways:

- Press and hold (for 3 seconds) the front panel PiP button
The latest PiP configuration appears
- Press the PiP button on the IR remote control transmitter (see [Section 8.4](#))
The latest PiP configuration appears
- Access the OSD menu, select INPUT>Display Mode, and then choose one of the preset PiP configurations (Picture in Picture, Picture + Picture or Split)
- Access the Web pages (see [Section 8.3](#))

7.2.2 Setting the OSD Menu to PiP Window Control

When the OSD menu is set to PiP Window Control, you can control the PiP window and change its parameters (for example, select the PiP input, size, position and so on). [Section 7.2.3.3](#) shows how to select the PiP source via the OSD menu.

To set the OSD menu to PiP control:

1. Press the MENU button to access the OSD menu.
2. Scroll down to the Misc menu and press ENTER.
3. Select the OSD submenu and press ENTER.
4. Select Window Control and choose PiP WINDOW.
The OSD menu controls the PiP source
5. Press the MENU button to exit and accept changes.
The OSD menu title will show PiP Window Control.
6. You can press the MENU button several times to exit the menu and save changes, or modify PiP window parameters via the other menu items.

To return to Main Window control, repeat the procedure above but select Main Window in the Window Control submenu.

7.2.3 Selecting the PiP Source

To select a PiP source you have to set the **VP-774AMP** to any of the PiP display mode configurations and then select the desired input.

7.2.3.1 Selecting the PiP Source via the Front Panel Buttons

Press and hold the PiP front panel button while pressing the input button of the required PiP source.

For example, to select CV as the PiP source over DP as the main source, press the PiP front panel button while pressing the CV front panel button (see [Figure 32](#)).

In this example, the DP button is illuminated and the CV button blinks

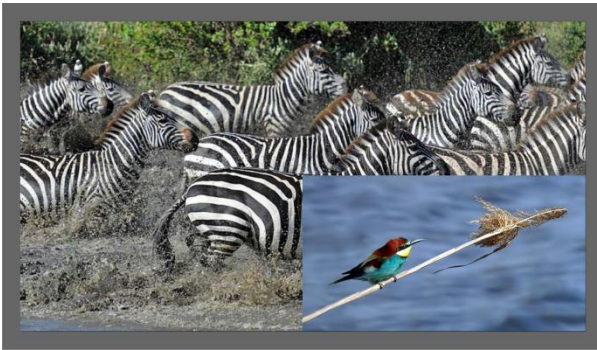

Figure 32: CV superimposed over DP

7.2.3.2 Selecting the PiP Source via the IR Remote Control Transmitter

Press the PiP button on the IR transmitter (the PiP front panel button is illuminated). Press the desired PiP source button on the IR transmitter (see [Section 8.4](#)).

7.2.3.3 Selecting the PiP Source via the OSD Menu



You can select an input source only after you set the display mode to one of the PiP configurations (see [Section 6.2](#)).

To set the PiP source via the OSD menu, do the following:

1. Press the MENU button to access the OSD menu.
2. Scroll through the menu, and for window specific submenus check the menu title:
 - If PiP Window Control appears, continue to step 7
 - If not, continue to the next step
3. Press the ▼ button to move to the Misc menu and press ENTER.
4. Select the OSD submenu and press ENTER.
5. Select Window Control and choose PiP Window Control.
The OSD menu controls the PIP source
6. Press the MENU button a number of times to return to the main OSD menu (and accept changes).
7. Scroll to the Input menu and press ENTER.
8. Select Input Source and press ENTER.
9. Choose the input for the PiP window.
10. Press the MENU a few times until you exit the OSD menu (changes are saved upon exit).

8 Controlling the VP-774AMP

The **VP-774AMP** can be controlled via:

- The front panel buttons (see [Section 8.1](#))
- The OSD menu (see [Section 8.2](#))
- The Web pages (see [Section 8.3](#))
- The infrared remote control transmitter (see [Section 8.4](#))

8.1 Controlling via the Front Panel Buttons

The **VP-774AMP** includes the following front panel buttons:

- Input selector buttons for selecting the required input: HDMI (1 to 4), PC (1 and 2), CV, DP and SDI (see [Section 8.1.1](#))
- PIP, BLANK and FREEZE buttons (note, these buttons illuminate when selected)
- MENU (left arrow), ENTER (right arrow), and up, down, arrow buttons
- Output volume up and down buttons (when not in the OSD mode)
- RESET TO XGA/720p and PANEL LOCK buttons

8.1.1 Using the INPUT Front Panel buttons

When selected, an INPUT front panel button behaves as follows:

Selecting the:	Causes the button to:
Main input button	Illuminate continuously
PiP input button	Blink (the light On period is shorter than the light Off period)
Same Main input button and PiP button	Blink (the light On period is longer than the light Off period)



If you want to adjust the image of a selected input in a window, press that input button again (up to 3 times) for fast tuning. Pressing that input button for the fourth time initiates full tuning of the window.

8.2 Controlling via the OSD Menu

You can change PiP Window parameters, main window parameters and entire system parameters via the OSD menu, as described in [Section 6.8](#).

8.3 Controlling via the VP-774AMP Web Pages

The Web pages are described in detail in [Section 9](#). You can remotely operate the **VP-774AMP** using a Web browser via the Ethernet connection (see [Section 8.3.3](#)). To be able to do so, you must use a supported Web browser:

For Windows 7 and higher:

- Chrome version 35
- Firefox version 30
- Internet Explorer version 10

For Mac (PC):

- Chrome version 35
- Firefox version 27
- Safari 7

For iOS:

- Chrome version 35
- Safari 7

For Android OS:

- Chrome version 35
- Safari 7

8.3.1 Connecting to the VP-774AMP via your Browser



Note that if the Protocol is set to Legacy (via the Miscellaneous menu, see [Section 6.8](#)), the Web pages may not function properly.

Make sure that your PC is connected via a network to the **VP-774AMP** and do the following:

1. Open your Internet browser.
2. Enter the unit's IP number or name in the Address bar of your browser.
If you are using DHCP, you have to enter the name.

The default IP number is 192.168.1.39, and may be changed by the system integrator



Figure 33: Entering the IP Number in the Address Bar

You can now control the machine via the Web page.

8.3.2 Connecting to the VP-774AMP via RS-232

You can connect to the **VP-774AMP** via an RS-232 connection using, for example, a PC. Note that a null-modem adapter/connection is not required.

To connect to the **VP-774AMP** via RS-232, connect the RS-232 9-pin D-sub rear panel port on the **VP-774AMP** unit via a 9-wire straight cable (only pin 2 to pin 2, pin 3 to pin 3, and pin 5 to pin 5 need to be connected) to the RS-232 9-pin D-sub port on your PC.

8.3.3 Connecting the VP-774AMP via the ETHERNET Port

You can connect to the **VP-774AMP** via Ethernet using either of the following methods:

- Directly to the PC using a crossover cable (see [Section 8.3.3.1](#))
- Via a network hub, switch, or router, using a straight-through cable (see [Section 8.3.3.2](#))

Note: If you want to connect via a router and your IT system is based on IPv6, speak to your IT department for specific installation instructions.

8.3.3.1 Connecting the Ethernet Port Directly to a PC

You can connect the Ethernet port of the **VP-774AMP** directly to the Ethernet port on your PC using a crossover cable with RJ-45 connectors.



This type of connection is recommended for identifying the **VP-774AMP** with the factory configured default IP address.

After connecting the **VP-774AMP** to the Ethernet port, configure your PC as follows:

1. Click **Start > Control Panel > Network and Sharing Center**.
2. Click **Change Adapter Settings**.
3. Highlight the network adapter you want to use to connect to the device and click **Change settings of this connection**.

The Local Area Connection Properties window for the selected network adapter appears as shown in [Figure 34](#).

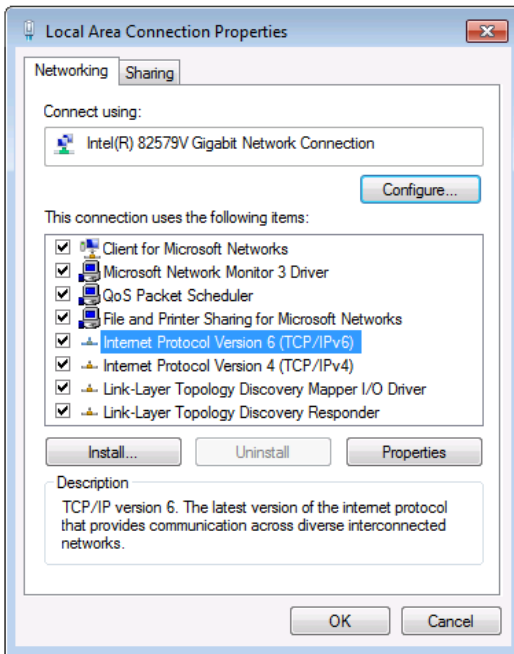

Figure 34: Local Area Connection Properties Window

4. Highlight either **Internet Protocol Version 6 (TCP/IPv6)** or **Internet Protocol Version 4 (TCP/IPv4)** depending on the requirements of your IT system.
5. Click **Properties**.

The Internet Protocol Properties window relevant to your IT system appears as shown in [Figure 35](#) or [Figure 36](#).

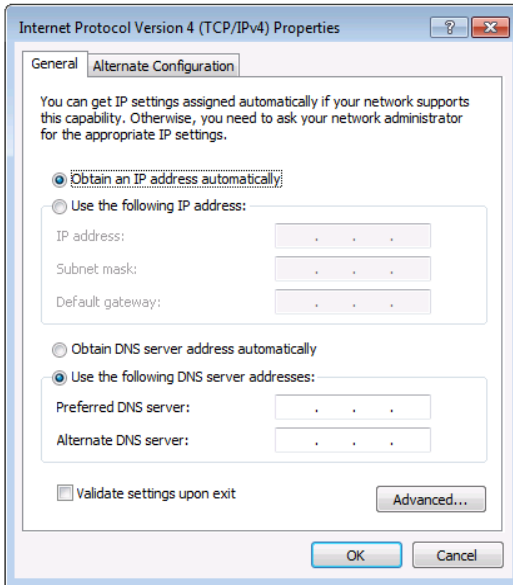

Figure 35: Internet Protocol Version 4 Properties Window

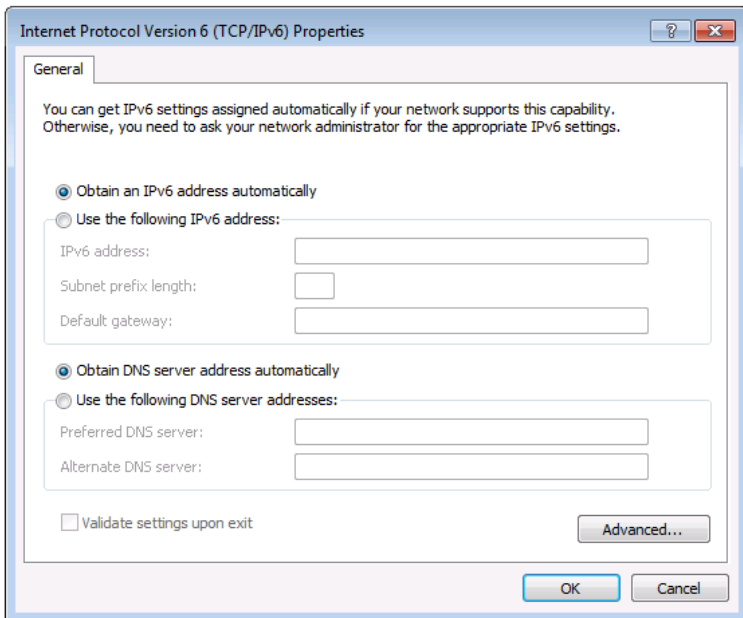

Figure 36: Internet Protocol Version 6 Properties Window

6. Select **Use the following IP Address** for static IP addressing and fill in the details as shown in [Figure 37](#).

For TCP/IPv4 you can use any IP address in the range 192.168.1.1 to 192.168.1.255 (excluding 192.168.1.39) that is provided by your IT department.

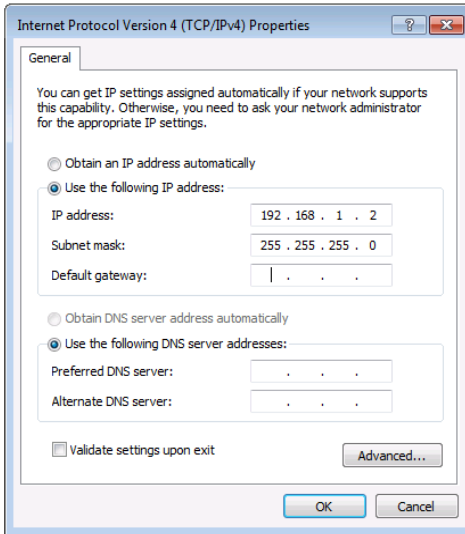

Figure 37: Internet Protocol Properties Window

7. Click **OK**.
8. Click **Close**.

8.3.3.2 Connecting the Ethernet Port via a Network Hub or Switch

You can connect the Ethernet port of the **VP-774AMP** to the Ethernet port on a network hub or using a straight-through cable with RJ-45 connectors.

8.3.3.3 Ethernet Port Configuration and Control

Use the Kramer K-UPLOAD software to configure the **VP-774AMP** and the Web pages to control it via the Ethernet.



The latest version of K-UPLOAD and installation instructions can be downloaded from the Kramer Web site at http://www.kramerelectronics.com/support/product_downloads.asp

8.4 Controlling via the Infrared Remote Control Transmitter

You can control the **VP-774AMP** from the infrared remote control transmitter:

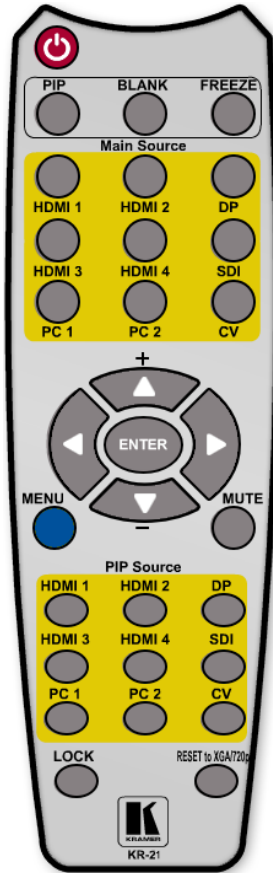

Figure 38: Infrared Remote Control Transmitter

Keys	Function	
POWER	Toggle the power save mode ON or OFF	
PIP	Enter the dual window mode (the latest setting), see Section 7.2 Note that while browsing the OSD menu in the dual window mode, a short press of the PIP button will instantly toggle the window control (between Main and PiP)	
BLANK	Toggle between a blank screen black screen and the display (for both windows)	
FREEZE	Freeze/unfreeze the output video image (for both windows)	
MAIN Source Inputs	HDMI1	Select the HDMI 1 input
	HDMI2	Select the HDMI 2 input
	DP	Select the DisplayPort input
	HDMI3	Select the HDMI 3 input
	HDMI4	Select the HDMI 4 input
	SDI	Select the SDI input
	PC1	Select the UXGA 1 input
	PC2	Select the UXGA 2 input
	+	Press ENTER to access menu levels (when in the OSD) Use the up and down arrows to adjust numerical values and adjust the output volume level (when not within the OSD)
	-	
MENU	Enter/Exit the OSD menu and return to the previous menu level	
MUTE	Toggle between muting (blocking out the sound) and enabling the audio output	
PIP Source Inputs	HDMI1	Select the HDMI 1 input
	HDMI2	Select the HDMI 2 input
	DP	Select the DisplayPort input
	HDMI3	Select the HDMI 3 input
	HDMI4	Select the HDMI 4 input
	SDI	Select the SDI input
	PC1	Select the UXGA 1 input
	PC2	Select the UXGA 2 input
CV	Select the composite video input	
LOCK	Lock the front panel buttons	
RESET to XGA/720P	Press to reset to the default resolution (toggles between RESET TO XGA and 720p)	

8.4.1 Using the IR Transmitter

You can use the IR transmitter to control the machine via the built-in IR receiver on the front panel or, instead, via an optional external IR receiver (Model: C-A35M/IRR-50). The external IR receiver can be located up to 15 meters away from the machine. This distance can be extended to up to 60 meters when used with three extension cables (Model: C-A35M/A35F-50).

Before using the external IR receiver, be sure to arrange for your Kramer dealer to insert the internal IR connection cable (P/N: 505-70434010-S) with the 3.5mm connector that fits into the REMOTE IR opening on the rear panel. Connect the external IR receiver to the REMOTE IR 3.5mm connector.

9 Using the Embedded Web Pages

The Web pages let you control the **VP-774AMP** via the Ethernet. The Web pages include all the OSD items and more.

Each one of the three control methods (front panel/IR transmitter, OSD menu or Web pages) affects the other two control methods. For example, selecting an input via the front panel buttons will affect the Routing & Scaling page (see [Section 9.1](#)) and the Input OSD menu (see [Section 6.2](#)).

To browse the **VP-774AMP** Web pages:

1. Open your Internet browser.
2. Type the IP number of the device in the Address bar of your browser. For example, the default IP number:



The Authentication window appears:

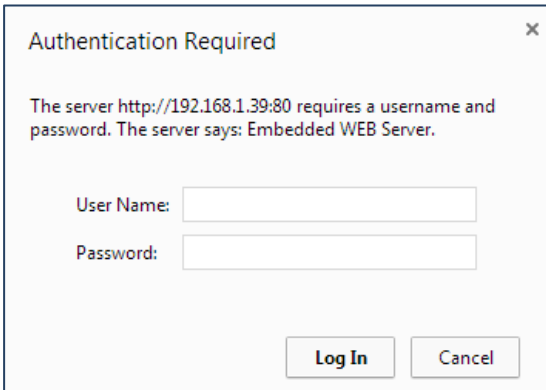

Figure 39: The Authentication Window

3. By default, the User Name is "admin" and the Password is "1234". You can change these settings via the Security page (see [Section 9.9](#)). The Loading page appears:

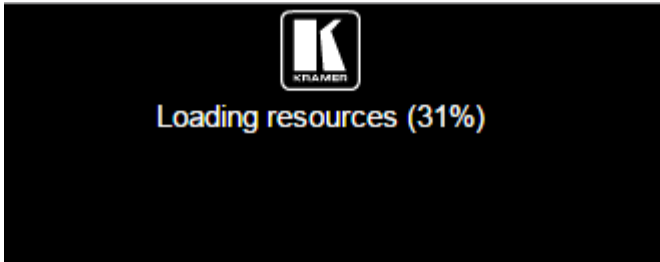

Figure 40: The Loading Page

There are 10 Web pages:

- The Routing & Scaling page (see [Section 9.1](#))
- The Device Settings page (see [Section 9.2](#))
- The Input Settings page (See [Section 9.3](#))
- The Enhance page (see [Section 9.4](#))
- The Output Settings page (see [Section 9.5](#))
- The Audio Settings page (see [Section 9.6](#))
- The RS-232 over TP page (see [Section 9.7](#))
- Emergency Alert System page(see [Section 9.8](#))
- The Security page (see [Section 9.9](#))
- The About Us page (see [Section 9.10](#))



Note that **VP-774AMP** in the Web pages appears as **VP-774A**.

9.1 The Routing and Scaling Page

Figure 41 shows the Routing & Scaling page that is also the first page that appears following the loading page. The column on the left shows the Routing & Scaling page selected and below a list of all the other available Web pages.

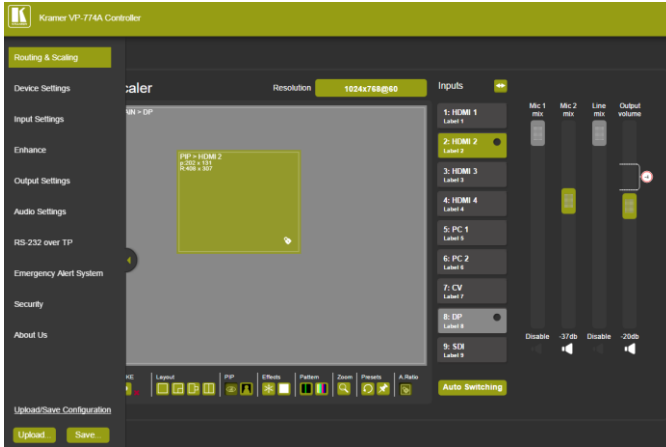

Figure 41: The Routing & Scaling Page with Web page list on the left

Click the arrow on the side to hide the Web pages list:

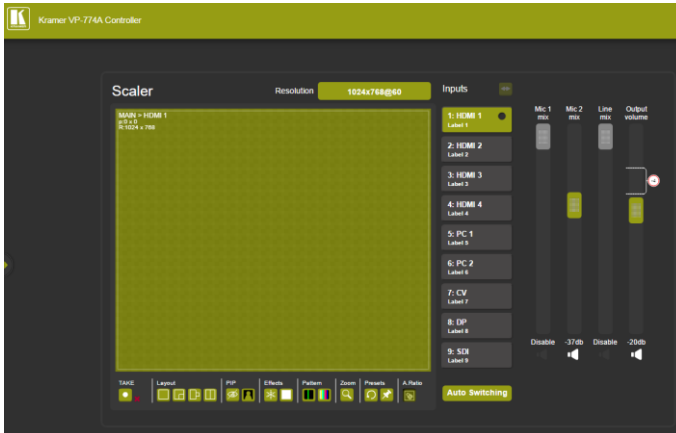

Figure 42: The Routing & Scaling Page – Single Window

The PIP image can be moved in any direction by clicking and moving the mouse and sized by moving the left and bottom edges of the image.



Figure 43: The Routing & Scaling Page – Moving the PIP Window

Note that for each window the top left side area shows the selected input and when selected, also shows the location of the image on the screen and its size.

Click a window to select it. A selected window turns green. An unselected main window appears dark gray and an unselected PIP window appears light gray.

The list of available inputs appears on the right side of the main area. The selected input appears green when its image in the main area is selected. For example, in [Figure 44](#) the PIP window is selected and on the right the respective input (2: HDMI 2) turns green.

The Routing & Scaling main area shows a depiction of the display which can show a single window (shown in [Figure 42](#)) or some variation of a MAIN window and a PIP window (one image over another), as illustrated in [Figure 44](#).

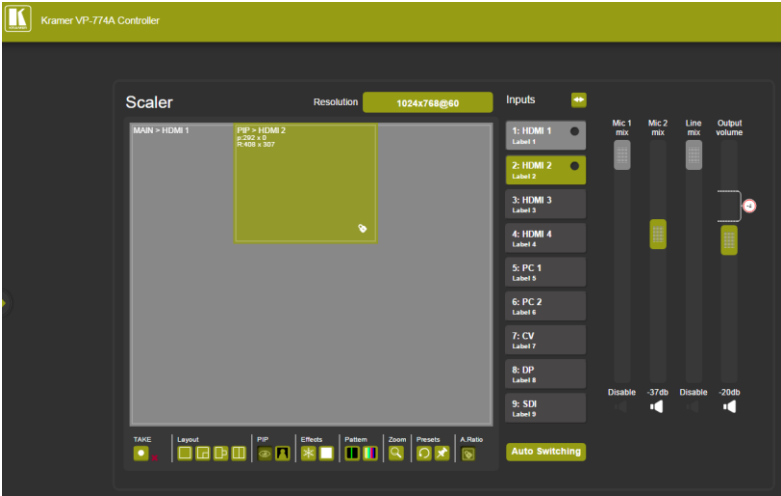

Figure 44: The Routing & Scaling Page – PIP Window

9.1.1 Selecting the Resolution

The Resolution selector above the main area lets you change the current resolution (for both images). Click the green button showing the current resolution (1024x768@60 in this example) to change it, see [Figure 45](#)



Figure 45: The Routing & Scaling Page – Changing the Resolution

9.1.2 Swapping Inputs

Press the Swap **Inputs** button to swap between MAIN and PiP inputs. For example, if the MAIN window displays input 3 and the PiP window displays input 1, these inputs swap places when clicking the Swap Inputs button, so the MAIN window will now show HDMI 1 and the PiP window will show HDMI 3



Figure 46: The Routing & Scaling Page – The Swap Inputs



Figure 47: The Routing & Scaling Page – Swapping the Inputs

9.1.3 Auto Switching

Click the Auto Switching button to open the Auto Switching window (see [Figure 48](#)). The Auto Switching window lets you set the Main and PiP scanning mode separately to:

- **Off** to disable scanning
- **Scan** mode to scan through the inputs in search of a valid input signal. In the scan mode you can select which of the inputs will be included in the scan (see [Figure 49](#)) and also change the order of the scanned inputs (see [Figure 50](#))
- **Last Connected** mode to immediately switch to the latest valid input signal connected (for HDMI and DP inputs only)
Note that in case the last connected valid input signal is disconnected, the **VP-774AMP** will switch to the previous last-connected valid-input signal, and then to the input before that and so on until the last disconnected inputs, and then a “No Signal” screen will appear

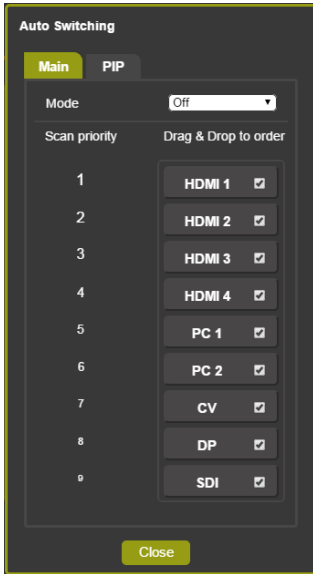

Figure 48: The Routing & Scaling Page – Auto Switching Window (Main Tab)

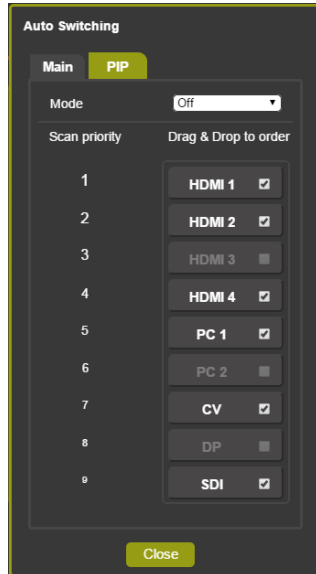

Figure 49: The Routing & Scaling Page – selecting the Inputs to Scan (PiP Tab)

When Scan mode is activated, the system scans the inputs from the highest to the lowest priority in search of a valid input signal for each the Main and PiP windows. The priority is ordered from the lowest input number (9) to the highest (1). For example, if PC 1 and HDMI 2 have a valid signal and auto switching is enabled, the **VP-774AMP** will scan through the inputs and select the HDMI 2 which is higher in the priority list (see [Figure 48](#)). Once the signal is no longer valid on HDMI 2, the **VP-774AMP** will scan for the next highest-priority valid signal.

Note that you can Check/uncheck the box next to an input to include/exclude it from the input scan list.

You can change the priority order as well by dragging an input button and dropping it in a new location, as illustrated in the example in [Figure 50](#). In this example, CV is moved up in the priority list to be scanned for a valid input after HDMI 1.

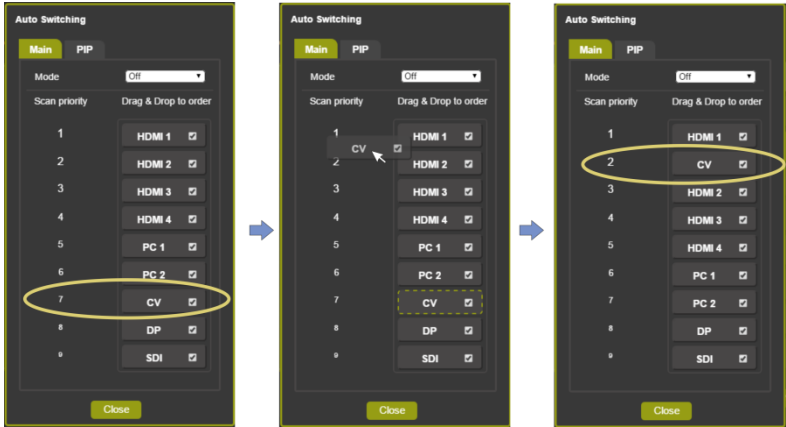

Figure 50: The Routing & Scaling Page – Auto Switching Window

9.1.4 The Lower Buttons Bar

The lower buttons bar lets you perform quick and easy setups:

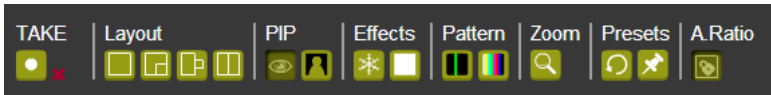
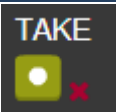

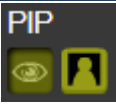
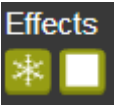

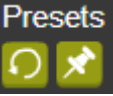
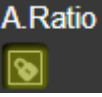

Figure 51: The Routing & Scaling Page – Lower Buttons Bar

Button	Function
	Click to apply changes or click x to cancel changes. TAKE applies to Win-cust (main and pip), Luma keying, Input source (main and pip), PiP status, freeze, blank and Zoom position/zoom, see Section 9.1.4.1
	Select one of the four standard setups. You can customize the size of each window by using the arrows (vertical and horizontal or diagonal if aspect ratio is locked – see below).
	Click to select PIP or single window
	Select freeze and/or blank effects

Button	Function
	Select a pattern
	Zoom the selected window
	Recall or save a preset (see below) Presets apply to: PIP status, Layout, Luma keying, Output volume, Mic 1 mix, Line mix, Mic2 mix, Output volume mute, Output volume delimiter, Mic 1 mix mute, Line mix mute, Mic2 mix mute, Win-cust (main and pip), Input source (main and pip), Output resolution all auto switching functions and Zoom position/zoom
	Lock/unlock the aspect ratio

Saving a Preset

To save a preset click the pin preset icon. Save Preset window appears. Click an empty (gray) preset (12 in this example).

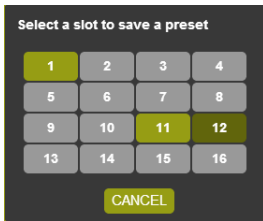

Figure 52: The Routing & Scaling Page – Selecting a Preset

Preset 12 is being saved:

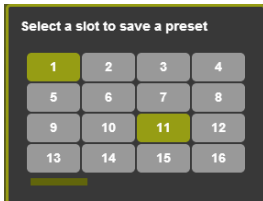

Figure 53: The Routing & Scaling Page – Saving the selected Preset

To recall a preset click the Preset recall icon:

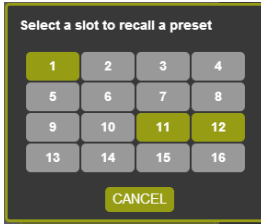

Figure 54: The Routing & Scaling Page – Recalling a Preset

9.1.4.1 The TAKE Mode

Click the TAKE button to enter the TAKE (Confirm) mode. A fine red line encircles the functions that apply to the TAKE mode (for example, the inputs):

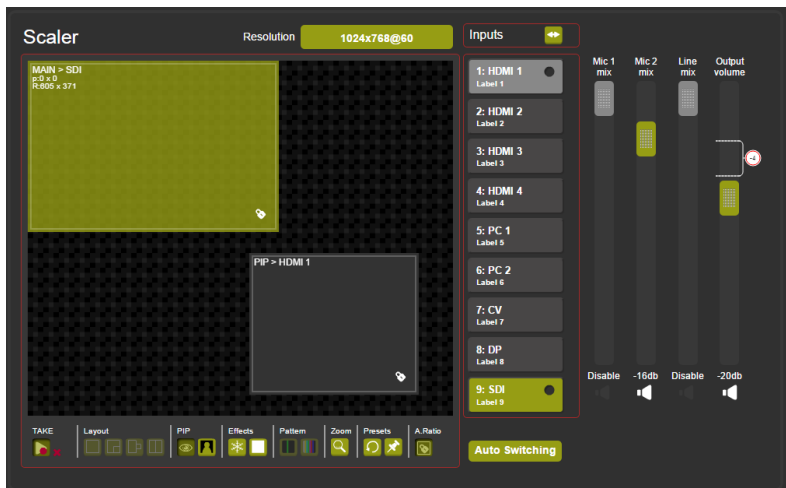

Figure 55: The Routing & Scaling Page – TAKE Mode

Set the changes (for example, the MAIN window input) and click the TAKE button once again. The changes are carried out and the red lines disappear.

Clicking the cancel button will cancel the changes (before pressing TAKE for the second time):

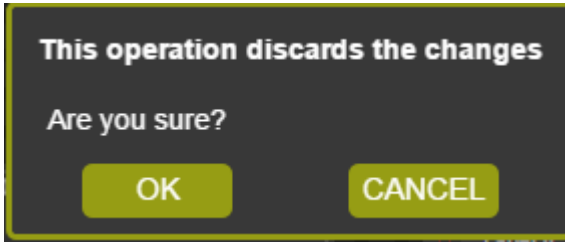

Figure 56: The Routing & Scaling Page – Cancel the Changes

9.1.5 Audio Level Sliders

The Mic/Line mix sliders are enabled via the Audio Settings page (see [Section 9.6](#))

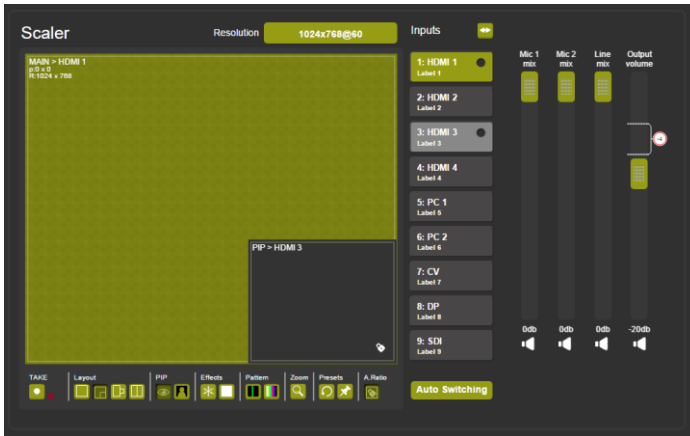

Figure 57: The Routing & Scaling Page – Audio Level Sliders

Audio levels can be set or muted via the speaker icon:



Figure 58: The Routing & Scaling Page – Muting the Audio Level

9.2 The Device Settings Page

The Device Settings window (in [Figure 59](#)) displays the device information, lets you upgrade the firmware, set the Ethernet parameters and reset the device to its default values.

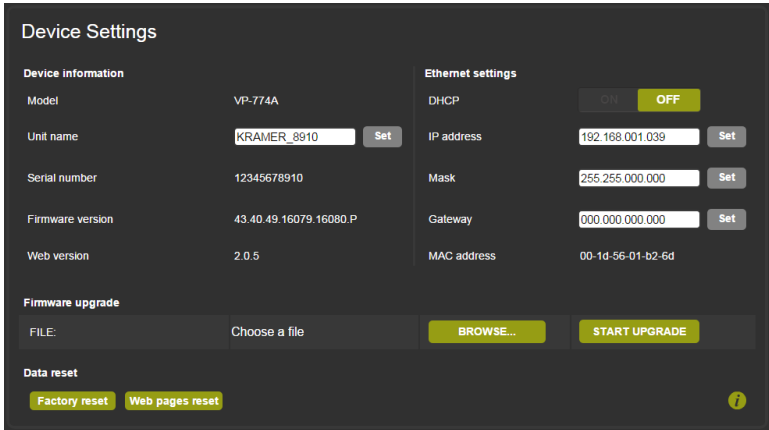

The screenshot shows the 'Device Settings' interface with the following sections:

- Device information:** Model (VP-774A), Unit name (KRAMER_0910), Serial number (12345678910), Firmware version (43.40.49.16079.16080.P), Web version (2.0.5).
- Ethernet settings:** DHCP (OFF), IP address (192.168.001.039), Mask (255.255.000.000), Gateway (000.000.000.000), MAC address (00-1d-56-01-b2-6d).
- Firmware upgrade:** FILE: Choose a file, with BROWSE... and START UPGRADE buttons.
- Data reset:** Factory reset and Web pages reset buttons.

Figure 59: The Device Settings Page

Any change in the device settings requires confirmation, as illustrated in the example in [Figure 60](#).

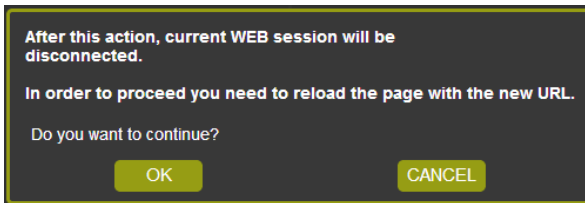

The dialog box contains the following text:

After this action, current WEB session will be disconnected.

In order to proceed you need to reload the page with the new URL.

Do you want to continue?

Buttons: OK, CANCEL

Figure 60: The Device Settings Page – Changing the IP number

9.2.1 Firmware Upgrade

You can upgrade the firmware via the Device Settings page. To do so:

1. Choose the firmware file by clicking the BROWSE button in the Firmware upgrade FILE line. The following window appears:

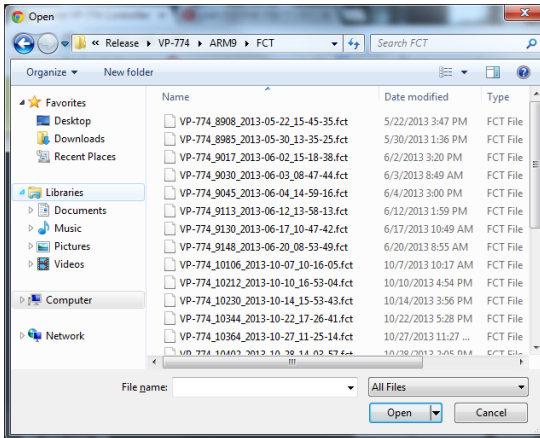

Figure 61: The Device Settings Page – Selecting the Firmware File

2. Select the firmware file and click open. The file name appears in the Device Settings Web page:

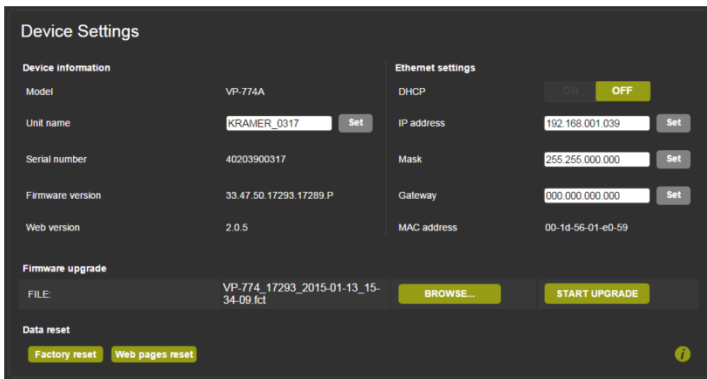

Figure 62: The Device Settings Page – Firmware File Downloaded

3. Click the START UPGRADE button. The following warning appears:

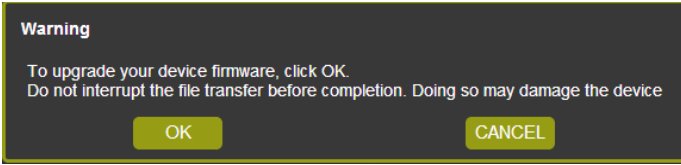

Figure 63: The Device Settings Page – Firmware Upgrade Warning

4. Click OK. The lower part of the screen displays the status of each upgrade process stage. The flash memory is erased and then the file is uploaded:

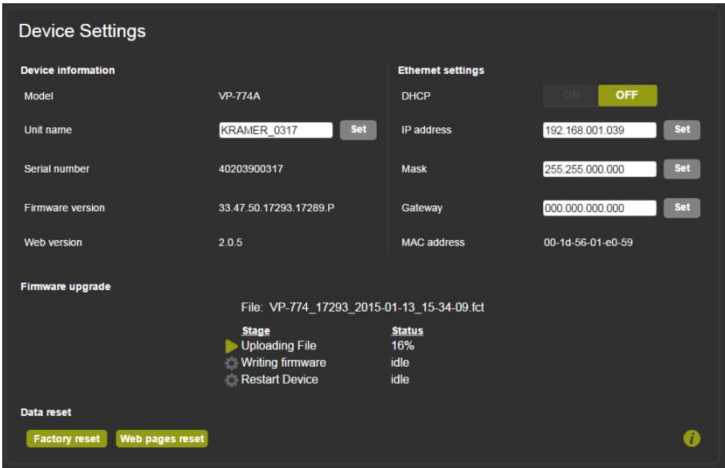

Figure 64: The Device Settings Page – Firmware Upgrade Stage

After the file is uploaded, the firmware is written (see [Figure 65](#)) and upon completion, the system automatically restarts (see [Figure 66](#)).

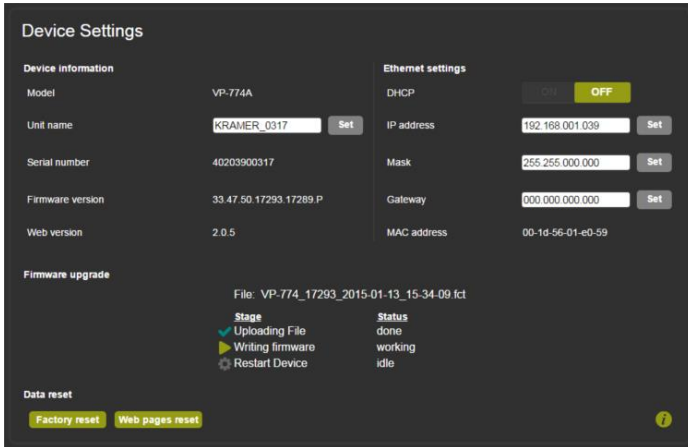

Figure 65: The Device Settings Page – Writing the Firmware

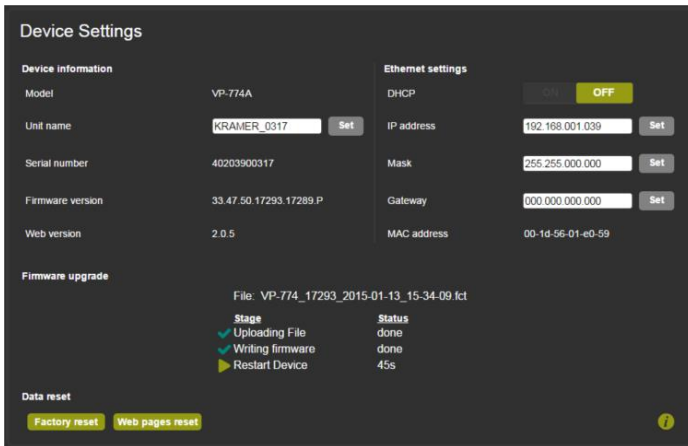

Figure 66: The Device Settings Page – Firmware Upgrade Waiting for Restart

Following reset, make sure that the updated firmware version appears in the Device Settings (Firmware version).

9.2.2 Factory Reset

You can reset the **VP-774AMP** parameters to their default state with or without the Ethernet parameters (see [Section 9.2.2.1](#)), as well as reset the Web pages only (see [Section 9.2.2.2](#)).

9.2.2.1 Device Reset

Click the Device reset button to reset the **VP-774AMP** to its default state. The following window appears:

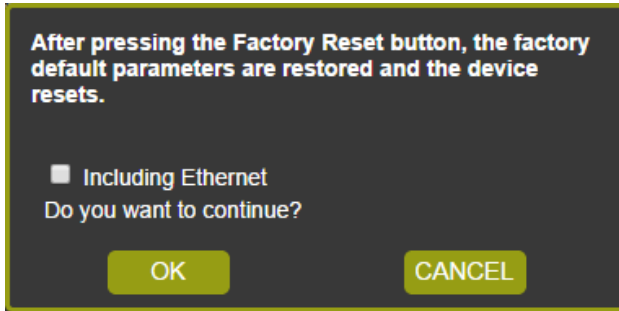

Figure 67: The Device Settings Page – The Reset Device Window

Check the box next to “Including Ethernet” to reset Ethernet parameters as well. You will be asked to reload the page with the default parameter.

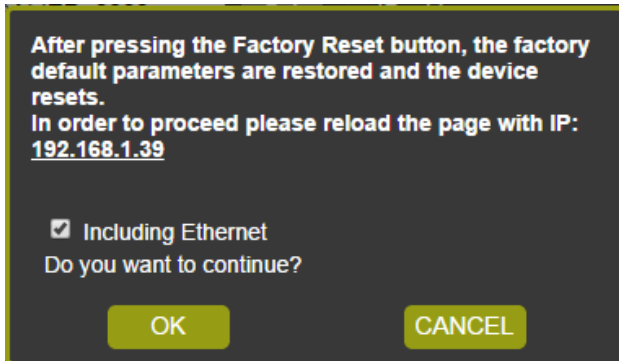

Figure 68: The Device Settings Page – The Reset Device Window Including Ethernet

Click OK. The following message appears:



You can also click the number in the message above to reload Web page.

9.2.2.2 Web Page Reset

To reset the Web page saved data (such as the label names, remote device commands, local messages and all other Web related changes that were made) click the Web-page reset button. The following window appears.

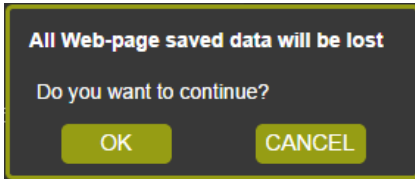
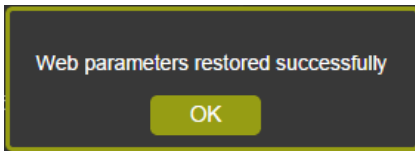



Figure 69: The Device Settings Page – Web Page Reset

Click OK if you want to continue.

The Web page resets and the following message appears:



9.2.3 Information

To access the information window, click the  icon on the lower right side of the page. You can click the  icon to refresh the window.

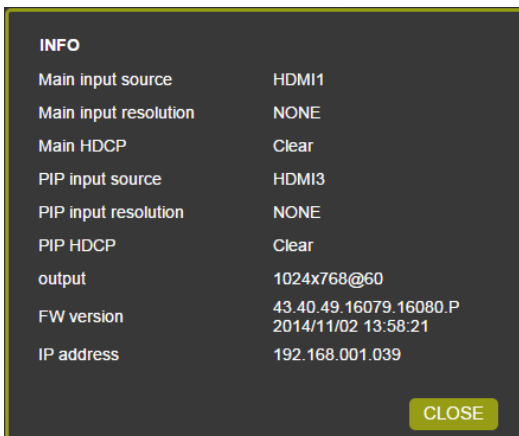

Figure 70: The Device Settings Page – The Information Window

9.3 The Input Settings Page

The Input Settings page (see [Figure 71](#)) lets you label the selected input on the main and PIP windows and define the input settings.

The screenshot shows the 'Input Settings' page with two columns for 'MAIN' and 'PIP' configurations. The 'MAIN' column is for 'DP - Label 8' and the 'PIP' column is for 'PC1 - Label 5'. Both columns have a 'Label' field with a save icon. The settings include Color space, Deinterlacing method, Deinterlacing sync, Film mode, Diagonal correction, Horizontal image shift, Vertical image shift, Image shift mode, MD sensitivity, Auto positioning, Overscan, HDCP mode, Gamma mode, and Dither. An 'EDID management' section is highlighted in green and includes Native resolution, Color depth, and EDID mode.

	MAIN	PIP
Label	Label 8	Label 5
Color space	RGB	Follow Input
Deinterlacing method	Line Doubler	Line Doubler
Deinterlacing sync	Current Field	Current Field
Film mode	Follow Input	Follow Input
Diagonal correction	2	2
Horizontal image shift	117	20
Vertical image shift	27	4
Image shift mode	Auto	Auto
MD sensitivity	LEVEL 3	LEVEL 3
Auto positioning	Off	Off
Overscan	Off	Off
HDCP mode	ON	OFF
Gamma mode	Off	
Dither	MODE 0	
EDID management		
Native resolution	1080p60	
Color depth	12bpp	
EDID mode	Multiple Modelines	

Figure 71: The Input Settings Page

Note that Color depth is available for HDMI and DP inputs only.

If the PIP window is not active, you can activate it by clicking the Activate PIP button (see [Figure 72](#)).

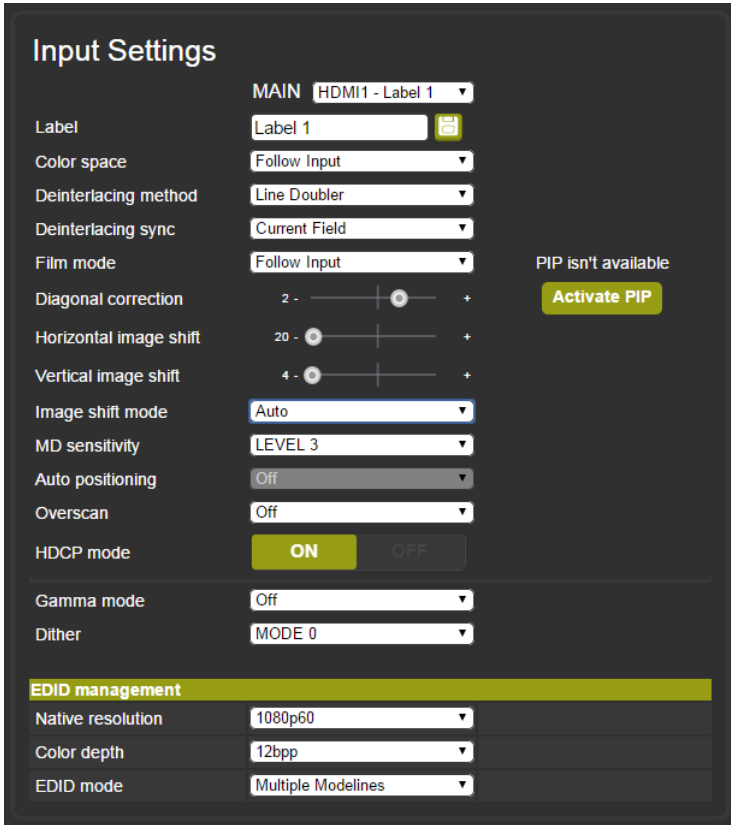

Figure 72: The Input Settings Page – PIP Window Inactive

The following table defines the Input Settings page items:

Button	Function
Label	Label the input
Color space	Select the color space for the PC and HDMI inputs
Deinterlacing method	Set the deinterlacing method (see Section 6.4)
Deinterlacing sync	Set the deinterlacing sync (see Section 6.4)
Film mode	Set the film mode (see Section 6.4)
Diagonal correction	Set the level of diagonal interpolation (see Section 6.4)
Horizontal image shift	Set the horizontal position of the image within the window (see Section 6.2)
Vertical image shift	Set the horizontal position of the image within the window (see Section 6.2)
Image shift mode	Set the image shift mode within the window (see Section 6.2)
MD sensitivity	Set the MD sensitivity (see Section 6.4)
Auto positioning	See Section 6.2

Button	Function
HDCP mode	Select the HDCP option for each HDMI input (see Section 6.2)
Gamma mode	Set the gamma correction factor (see Section 6.5)
Dither	Set the error diffusion (see Section 6.5)
EDID management	Set the native resolution for each input and then select the color depth (see EDID Select in Section 6.2) Select the EDID mode: Native as Multiple Modelines – generating a group of resolutions in the detailed timing, including the native resolution), or Native as Single Modeline – generating only the native resolution in the detailed timing

Note that if auto switching is enabled, the Input Setting Web page is disabled and the following message is displayed:

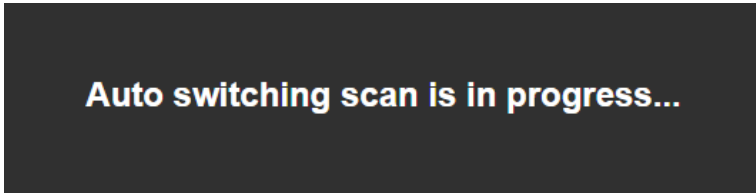

9.4 The Enhance Page

The Enhance page lets you improve the appearance of the image:

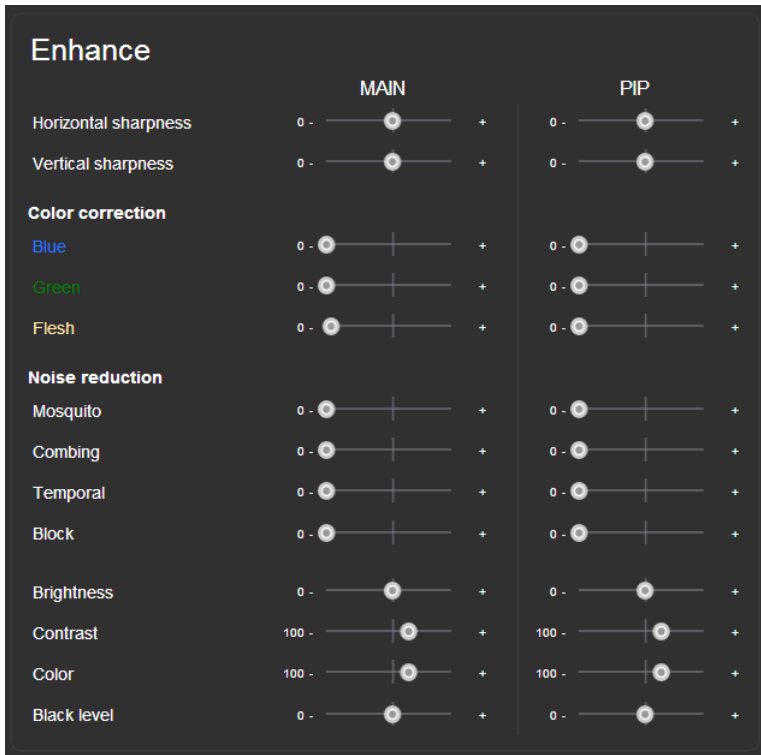

Figure 73: The Enhance Page

The following table defines the Enhance page items:

Button	Function
Horizontal sharpness	Select the horizontal sharpness level (see Section 6.6)
Vertical sharpness	Select the vertical sharpness level (see Section 6.6)
Color correction	Set the blue, green and flesh color levels (see Section 6.5)
Noise reduction	Set the input noise reduction levels (see Section 6.6)
Brightness	Set the brightness level (see Section 6.5)
Contrast	Set the contrast level (see Section 6.5)
Color	Set the color level (see Section 6.5)
Black level	Set the black level (see Section 6.5)

9.5 The Output Settings

The Output Settings page lets you define the output parameters:

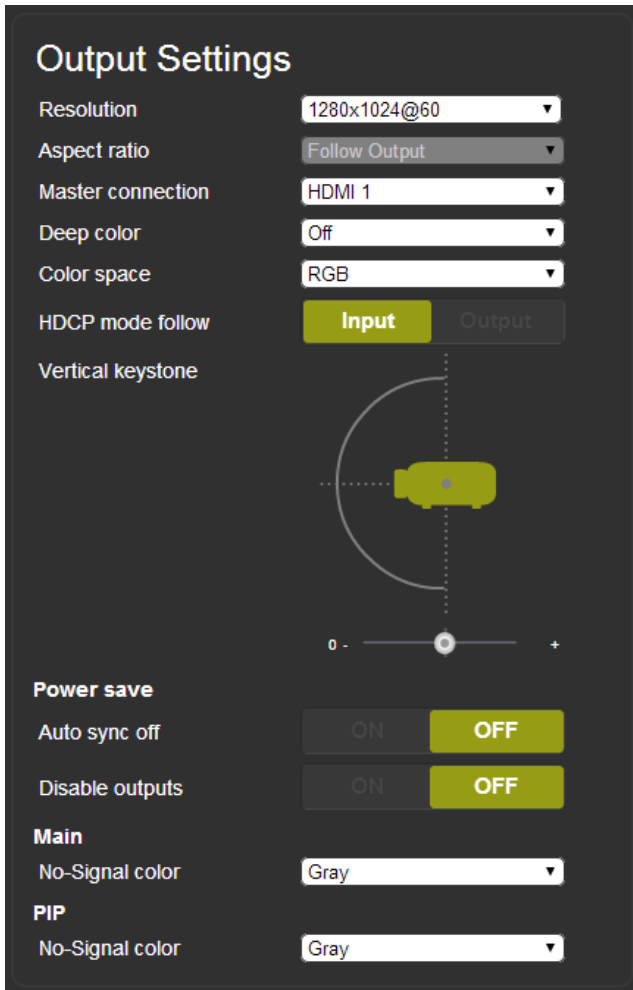

Figure 74: The Output Settings Page

Set the output resolution, the aspect ratio, the master connection, deep color and HDCP mode (see [Section 6.7](#)), as well as the vertical keystone, power-save settings and the color of the window if there is no signal on the input (see [Section 6.8](#)).

9.6 The Audio Settings Page

The audio settings page includes two tabs: the General tab (see [Section 9.6.1](#)) and the Microphone tab (see [Section 9.6.2](#)). The features described in both tabs are detailed in [Section 6.3](#).

9.6.1 The General Tab

The General tab (see [Figure 75](#)) lets you set the general audio parameters for the selected main window input and the outputs.

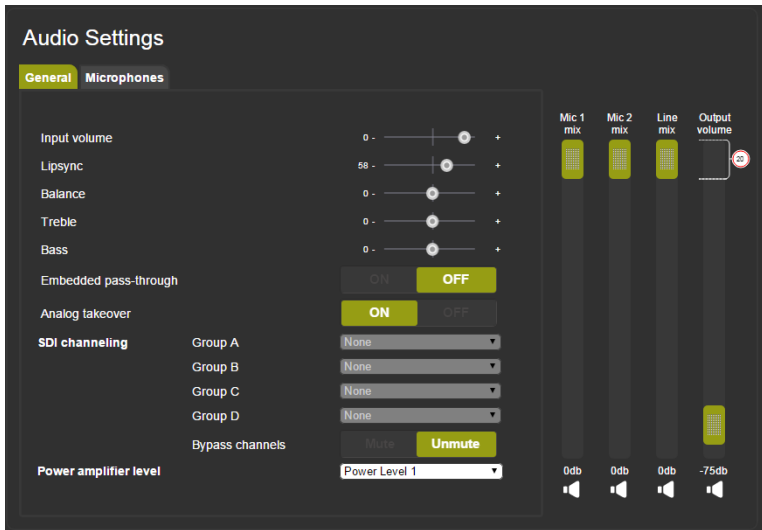

Figure 75: The Audio Settings Page – General Tab

Set the input volume, lipsync, balance, treble and bass. Set the embedded audio input to pass-through directly to the output; set analog takeover to have the analog input takeover the embedded input. Set the SDI channeling (see [Section 6.3.1](#)) and set the bypassed channels to Mute or Unmute, and set the power amplifier level to 1 of 4 levels.

Note that if the Embedded pass-through is set to ON, Analog takeover, as well as Mic 1, Mic 2 and Line mix, and the output volume are disabled.

9.6.2 The Microphones Tab

The Microphones tab (see [Figure 76](#)) lets you setup the microphone parameters.

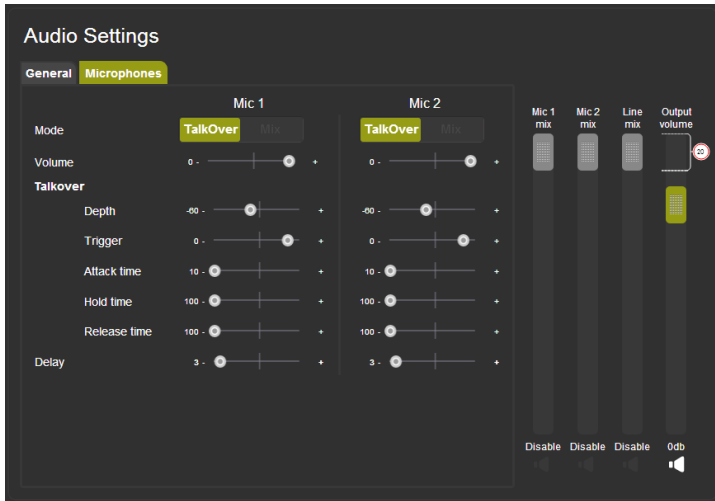

Figure 76: The Audio Settings Page – Microphones Tab

Set the microphone operation mode to Talkover or Mix. If Talkover is selected for both microphones, the Mic 1/Mic 2 sliders are disabled:

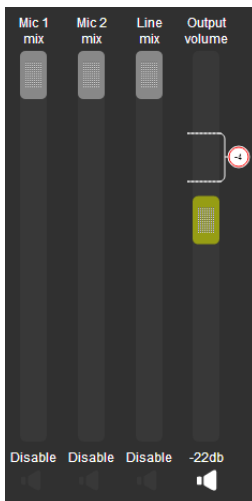

Figure 77: The Audio Settings Page – Microphones Tab

If, for example, Mic 2 is set to Mix, the Mic 2 slider is enabled and you can set the mix level:

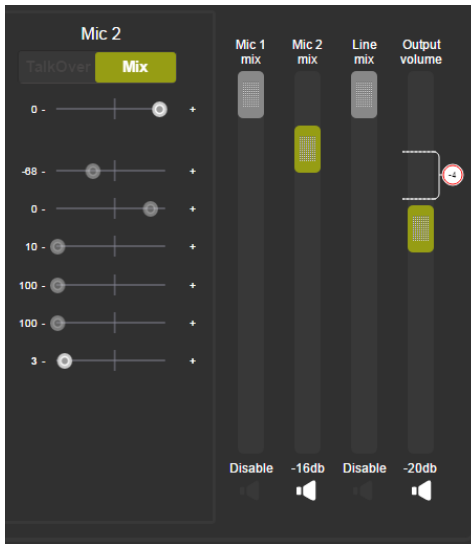

Figure 78: The Audio Settings Page – Setting the Mix Level

You can set the maximum value of the Output Volume by using the pre-limiter on the Output Volume slider. Slide the pre-limiter up or down to determine the maximum allowed volume. The value below shows the maximum allowed value selected:

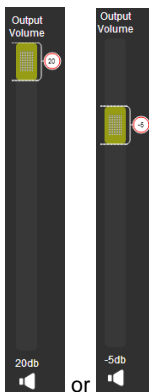

Figure 79: The Audio Settings Page – Output Volume Pre-limiter

In the Talkover mode you can set the:

- **Depth** to determine the decrease of the audio level during microphone takeover
- **Trigger** to determine the microphone 1 threshold level that triggers the audio level decrease
- **Attack time** to set the transition time of the audio level reduction after the signal rises above the threshold level
- **Hold time** to define the time period talkover remains active although the signal falls below the threshold level (for a short period of time)
- **Release time** to define the transition time for the audio level to return from its reduced level to its normal level after the Hold Time period

9.7 The RS-232 over TP Page

The RS-232 over TP page lets you configure the tunneling port and send various messages through this port (see [Section 10](#)).

RS-232 Over TP

Port tunneling

Protocol type: UDP TCP

Ethernet port: 5050

Serial configurations

Parity: None

Data bits: 8

Baud rate: 9600

Stops bits: 1

Apply

Remote device commands

	Description	Command	Trigger By		
▶	Desc1	0xFF,0xFF	Manual only	🔍	🗑️
▶	Desc2	0xFF,0xFF	Manual only	🔍	🗑️
▶	Desc3	0xFF,0xFF	Manual only	🔍	🗑️
▶	Desc4	0xFF,0xFF	Manual only	🔍	🗑️
▶	Desc5	0xFF,0xFF	Manual only	🔍	🗑️
▶	Desc6	0xFF,0xFF	Manual only	🔍	🗑️
▶	Desc7	0xFF,0xFF	Manual only	🔍	🗑️
▶	Desc8	0xFF,0xFF	Manual only	🔍	🗑️

Figure 80: The RS-232 over TP Page

Set the port tunneling protocol type and Ethernet port as well as the parity, Data bits, baud rate and stop bits.

The table in the lower part of this window shows the list of commands:

	Description	Command	Trigger By		
+					
▶	Desc1	0xFF,0xFF	Manual only	✎	🗑
▶	Desc2	0xFF,0xFF	Manual only	✎	🗑
▶	Desc3	0xFF,0xFF	Manual only	✎	🗑
▶	Desc4	0xFF,0xFF	Manual only	✎	🗑
▶	Desc5	0xFF,0xFF	Manual only	✎	🗑
▶	Desc6	0xFF,0xFF	Manual only	✎	🗑
▶	Desc7	0xFF,0xFF	Manual only	✎	🗑
▶	Desc8	0xFF,0xFF	Manual only	✎	🗑

Figure 81: The RS-232 over TP Page – the Remote Device Commands Table

To write or edit a command click the edit icon. The following window appears:

Edit command #1

Description

Command
Command in "0xFF,0xFF ... 0xFF" format

Trigger by

Figure 82: The RS-232 over TP Page – the Edit Command Window

Fill in the details. For example, to power on a projector, fill in the details and select the trigger and the trigger delay time in seconds before the command is carried out (note that for Manual only, the trigger delay time is disabled):

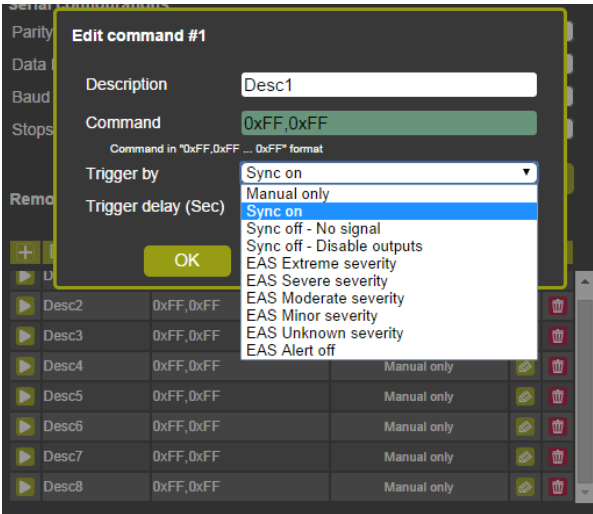

Figure 83: The RS-232 over TP Page – Setting the Trigger

In this example, Sync on triggers the power on command and the delay is set to 30 seconds.

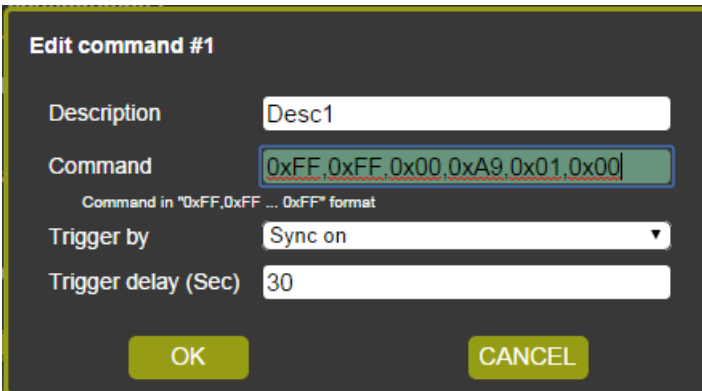
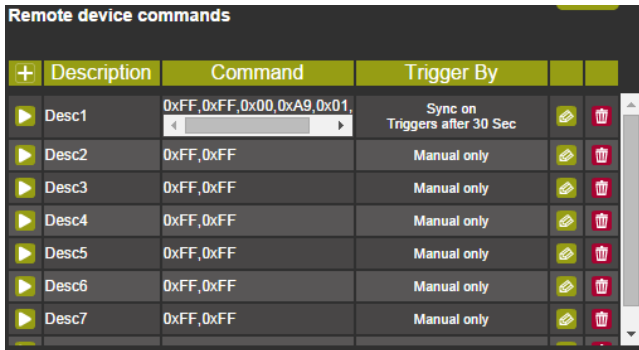

Figure 84: The RS-232 over TP Page – Setting the Sync on Trigger

Click OK to save the command to the list:



	Description	Command	Trigger By		
▶	Desc1	0xFF,0xFF,0x00,0xA9,0x01,	Sync on Triggers after 30 Sec	🔗	🗑️
▶	Desc2	0xFF,0xFF	Manual only	🔗	🗑️
▶	Desc3	0xFF,0xFF	Manual only	🔗	🗑️
▶	Desc4	0xFF,0xFF	Manual only	🔗	🗑️
▶	Desc5	0xFF,0xFF	Manual only	🔗	🗑️
▶	Desc6	0xFF,0xFF	Manual only	🔗	🗑️
▶	Desc7	0xFF,0xFF	Manual only	🔗	🗑️

Figure 85: The RS-232 over TP Page – the Power on Command

The system will send a Power on command to the projector connected to the output whenever a signal is detected.

9.8 The Emergency Alert System Page

The emergency Alert System lets you setup the emergency system on your **VP-774AMP** (for further details, see [Section 6.8.2](#)).

Emergency Alert System

Connect to EAS server

Protocol type: UDP TCP

Ethernet port:

Local message

Severity

Extreme **Big Alert & Siren**

Severe **Big Alert**

Moderate **Alert Crawler**

Minor **Big Message**

Unknown **Message Crawler**

Status:

Scope:

Message type:

Category:

Urgency:

Certainty:

Sender:

Expiration date:

Expiration time: :

Auto expiration minutes from now

Event:

Headline:

Description:

Instructions:

CAP file:

Figure 86: The Emergency Alert System Page

The top part lets you set the means to connect to the EAS server (UDP or TCP) and set the Ethernet port. Click Apply to apply changes.

Check the box next to Local message to create a local message that will be seen on the display. To create the local message, fill in the following details:

Item	Function
Severity	Click on an icon to set the severity level to Extreme (a big alert and a siren), Severe (a big alert) or Moderate (an alert crawler) alert layouts as well as Minor (a big message) or Unknown (a message crawler) message layouts
Status	Set the status to Actual, Exercise, System or Test
Scope	Set the scope to Public, Restricted or Private
Message type	Set the message type to Alert, Update, Cancel, Acknowledgement or Error
Category	Set the category to Geophysical (for example landslide), Meteorological (for example, a flood), Safety, Security, Rescue, Fire, Health, Environmental (for example, pollution) Transport, Infra (for example, telecommunication), Other
Urgency	Set the urgency level to Immediate, Expected, Future, Past or Unknown
Certainty	Set the certainty to Very Likely, Likely, Possible, Unlikely or Unknown
Sender	Type in the details of the alarm sender (for example an email, the name of the institute and so on)
Expiration date	Set the expiration date
Expiration time	Set the expiration time
Auto Expiration	Set the alarm to expire after a defined time period (disables expiration date and time)
Import	Click the Import button to load a CAP file (Common Alerting Protocol); select the file and click open – the alert will appear in the message text boxes
Export	Export the local alert to the Downloads folder
Send	Send the alert to the device

In the example shown in [Figure 87](#), an extreme weather condition alarm is created. You can save the alarm, and/or send it immediately:

The screenshot shows a dark-themed form for creating an emergency alert. It contains the following elements:

- Event:** A text input field containing "Weather Alert".
- Headline:** A text input field containing "Extreme heat".
- Description:** A larger text area containing "Temperatures are expected to reach a high of 40 degrees Celsius".
- Instructions:** A text input field containing "Drink Plenty of water".
- CAP file:** Two green buttons labeled "Import" and "Export".
- Send:** A grey button labeled "Send".

Figure 87: The Emergency Alert System Page – Local Message Example

9.9 The Security Page

The Security page defines two security levels:

- No username or password required
- Access to all settings requires a valid username and password

When security is activated, you can change the password

By default, the Security page is deactivated and there is no need to enter a username and password to access the Web pages:

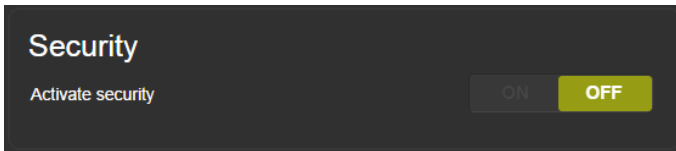

Figure 88: The Security Page – Security Deactivated

To activate security, press the ON button:

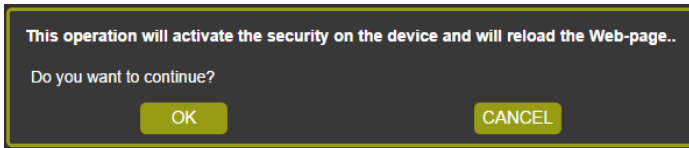

Figure 89: The Security Page – Activating the Security

Click OK.

The Web Page reloads and the following message appears for you to fill in:

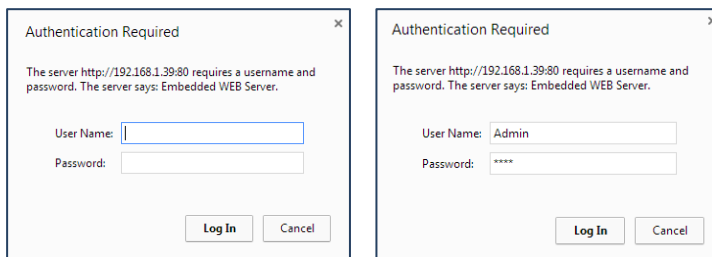

Figure 90: The Security Page – Authentication Required

The Security page (now activated) lets you change the user name and password:

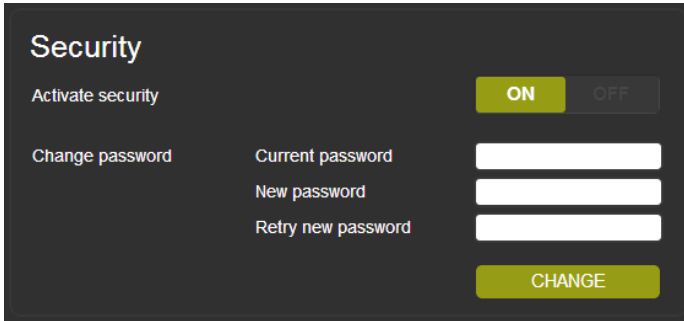

Figure 91: The Security Page

9.10 The About Us Page

The **VP-774AMP** About Us page lets you view the Web page version and Kramer Electronics Ltd details.



Figure 92: The About Us Page

9.11 Save or Upload a Configuration

The **VP-774AMP** Web page lets you upload a saved configuration or save a configuration. To do so, click the Upload (see [Figure 93](#)) and Save (see [Figure 94](#)) buttons, respectively, which are located at the lower part of the menu list.



Note that the configuration is automatically saved to the Downloads folder and uploaded from it as well

When saving a configuration, the file automatically saves it to the Downloads

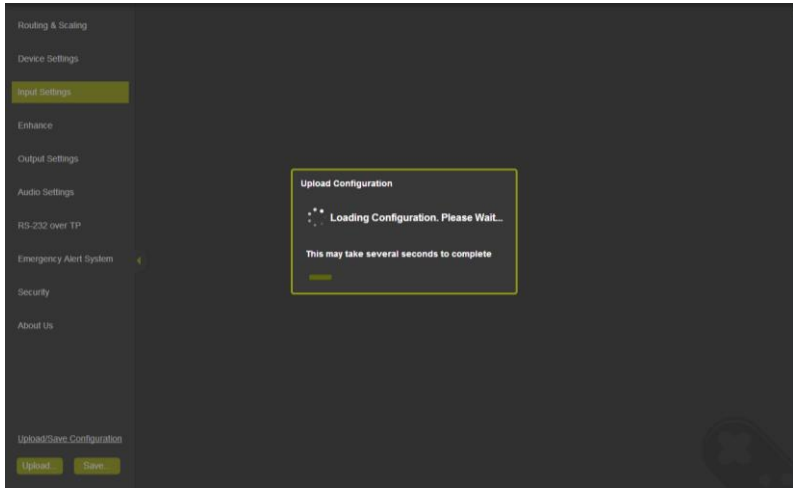

Figure 93: Loading a Configuration

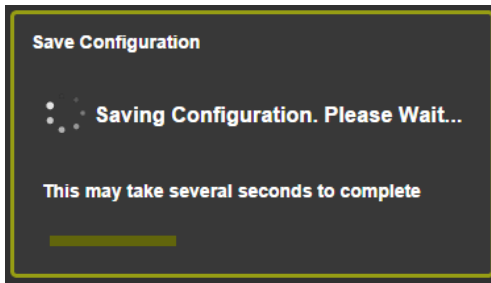

Figure 94: Saving a Configuration

10 Port Tunneling

The port tunneling feature lets you send and receive simple RS-232 signals between a controller and a serial device via the **VP-774AMP** which is connected to the Ethernet and outputs via TP cable.

The example, illustrated in [Figure 95](#), shows a Kramer room controller that is connected to the **VP-774AMP** via the Ethernet. The HDBT OUT connector on the **VP-774AMP** is connected via TP to an HDBT receiver. This HDBT receiver connects to a display via HDMI and RS-232.

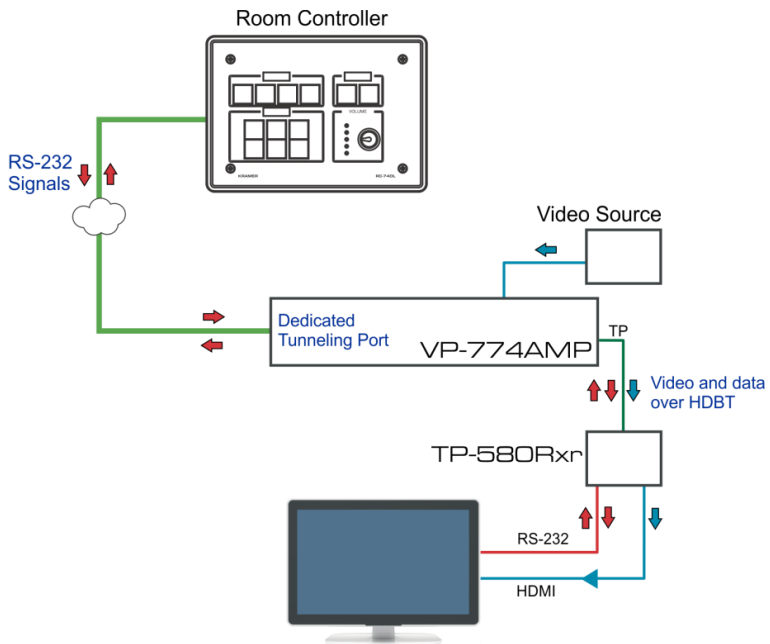

Figure 95: Port Tunneling

The room controller sends RS-232 signals over the Ethernet via a dedicated Tunneling port to the **VP-774AMP**. The **VP-774AMP** sends these signals via TP to a display that is connected to the receiver. This way, control data can flow between the room controller and the display device, tunneling through the **VP-774AMP**.

To setup and activate port tunneling on the **VP-774AMP**:

1. Set the dedicated port tunneling Ethernet connection port type and port number through which the **VP-774AMP** will be passing RS-232 signals. By default, the dedicated port settings are TCP, 5050. To change these settings see the “Port Tunneling Configuration” in the table in [Section 13.4](#) or via the embedded Web pages (see [Section 9.7](#)).
2. Set the HDBT UART command (the table in [Section 13.4](#)). By default, the settings are 9600,8,N,1
3. Make sure that the **VP-774AMP** is connected to Ethernet.

The **VP-774AMP** is now ready to tunnel RS-232 signals via Ethernet port tunneling.

11 Flash Memory Upgrade

You can upgrade the **VP-774AMP** via the Kramer K-UPLOAD software. Two types of upgrade files are available for upgrade: video core and audio/graphics (*.fct) and peripherals (*.kfw).



The latest firmware version, the Flash Memory Upgrade user guide, as well as the latest version of K-UPLOAD and installation instructions can be downloaded from the Kramer Web site at

<http://www.kramerelectronics.com/support/downloads.asp>

Note that if the Protocol is set to Legacy (via the Miscellaneous menu, see [Section 6.8](#)), the Web pages may not function properly.

12 Technical Specifications

INPUTS:	4 HDMI (deep color) connectors 2 VGA on 15-pin HD connectors 1 composite video on an RCA connector 1 DisplayPort connector 1 SDI (looping) on BNC connectors 4 HDMI, 2 VGA, 1 DP, 1 CV unbalanced stereo audio on left and right RCA connectors 2 Mic unbalanced and high impedance on 6mm jack connectors (with selectable 48V phantom power)
OUTPUTS:	1 SDI on a BNC connector 2 HDMI (deep color) connectors 1 HDBaseT on an RJ-45 connector 1 S/PDIF digital audio on an RCA connector 1 balanced stereo audio on a 5-pin terminal block connector 1 stereo speaker output, 2x10W into 8Ω, on a 4-pin terminal block connector
COMPLIANCE WITH HDMI STANDARD:	Supports HDMI (deep color) and HDCP Supports: DisplayPort 1.1a
OUTPUT RESOLUTIONS:	640x480@60, 640x480@75, 800x600@50, 800x600@60, 800x600@75, 1024x768@50, 1024x768@60, 1024x768@75, 1280x768@50, 1280x768@60, 1280x800@60, 1280x1024@50, 1280x1024@60, 1280x1024@75, 1360x768@60, 1366x768@50, 1366x768@60, 1400x1050@50, 1400x1050@60, 1600x900@60, 1600x1200@50, 1600x1200@60, 1680x1050@60, 1920x1200@60, 480i60, 480p60, 576i50, 576p50, 720p50, 720p59.94, 720p60, 1080p23.976, 1080p24, 1080p25, 1080p29.97, 1080p30, 1080p50, 1080p59.94, 1080p60, 2048x1080@60Hz, 2048x1080@50Hz
CONTROLS:	Front panel buttons, OSD, IR remote control, RS-232 on a 9-pin D-sub connector, Ethernet
OPERATING TEMPERATURE:	0° to +40°C (32° to 104°F)
STORAGE TEMPERATURE:	-40° to +70°C (-40° to 158°F)
HUMIDITY:	10% to 90%, RHL non-condensing
POWER CONSUMPTION:	100-240V AC, 70VA max.
DIMENSIONS:	19" (W), 9.3" (D) 1U (H) rack mountable
WEIGHT:	2.5kg (5.5lbs) approx.
INCLUDED ACCESSORIES:	Power cord, rack "ears", IR remote control
OPTIONS:	Kramer BC-HDKat6a cable
<p>Specifications are subject to change without notice For the most updated resolution list, go to our Web site at http://www.kramerelectronics.com</p>	

12.1 Default Communication Parameters

RS-232		
Protocol	3000 (Default)	Legacy
Baud Rate:	115,200	9,600
Data Bits:	8	8
Stop Bits:	1	1
Parity:	None	None
Command Format:	ASCII	ASCII
Example (Set display mode to Picture in Picture):	#Y 0,110,1<CR>	>Y 0 110 1<CR>
Ethernet		
To reset the IP settings to the factory reset values, power cycle the device while holding in the Ethernet Reset button, located on the rear panel of the unit		
IP Address:	192.168.1.39	
Subnet mask:	255.255.000.000	
Default gateway:	000.000.000.000	
TCP Port #:	5000	
UDP Port #:	50000	
Maximum UDP Ports:	10	
Maximum TCP Ports:	4	
Web page password	1234	
Full Factory Reset		
Front panel buttons	Turn power off. Turn power on again while holding the RESET TO XGA/720p front panel button. The LEDs blink. Full factory reset is complete once the LEDs cease to blink and react normally. Note that full factory reset includes Ethernet reset as well	
OSD	Factory Reset through the Misc menu item	
Web pages	Factory reset via the Device Settings embedded Web page	
Protocol 3000	Use "Factory" command or #Y 0,770,1<CR>	

12.2 Input Resolutions

This section defines the input resolutions for each input

12.2.1 SDI Input Resolutions

SDI Input Resolution			
NTSC	720_P60	1080_P24	1080_P50
PAL	1080_I50	1080_P25	1080_P60
720_P50	1080_I60	1080_P30	

12.2.2 PC Input Resolutions

PC Input Resolutions				
640X480_60	800x600_75	625_P50	1280x1024_60	1400x1050_75
640x480_72	800x600_85	525_P60	1280x1024_75	1600x900_60
640x480_75	1024x768_60	720_P50	1280x1024_85	1600x1200_60
640x480_85	1024x768_70	720_P60	1360x768_60	1680x1050_60
800x600_56	1024x768_75	1280x800_60	1366x768_60	1920x1200_60RB
800x600_60	1024x768_85	1280x960_85	1440x900_60	1080_P50
800x600_72	1152x864_75	1280x768_60	1400x1050_60	1080_P60

12.2.3 DP Input Resolutions

DP Input Resolutions				
640X480_60	800x600_85	1280x800_60	1366x768_60	1920x1200_60RB
640x480_75	848x480_60	1280x960_85	1440x900_60	720_P60
640x480_85	1024x768_60	1280x768_60	1400x1050_60	1080_P60
800x600_56	1024x768_70	1280x1024_60	1400x1050_75	2k50
800x600_60	1024x768_75	1280x1024_75	1600x900_60	2k 60
800x600_72	1024x768_85	1280x1024_85	1600x1200_60	
800x600_75	1152x864_75	1360x768_60	1680x1050_60	

12.2.4 CV Input Resolutions

NTSC and PAL

12.2.5 HDMI Input Resolutions

HDMI Input Resolutions				
NTSC	1080_I60	640x480_72	1024x768_70	1360x768_60
PAL	1080_P23_976	640x480_75	1024x768_75	1366x768_60
525_P60	1080_P24	640x480_85	1024x768_85	1440x900_60
625_P50	1080_P25	800x600_56	1152x864_75	1400x1050_60
720_P24	1080_P30	800x600_60	1280x800_60	1400x1050_75
720_P25	1080_P50	800x600_72	1280x960_85	1600x900_60
720_P30	1080_P60	800x600_75	1280x768_60	1600x1200_60
720_P50	2k50	800x600_85	1280x1024_60	1680x1050_60
720_P60	2k60	848x480_60	1280x1024_75	1920x1200_60RB
1080_I50	640X480_60	1024x768_60	1280x1024_85	

12.3 Output Resolutions

This section defines the output resolutions

12.3.1 HDMI Output Resolutions

Technical Specifications of the HDMI Output Signal			
640x480@60	1280x1024@50	1680x1050@60	1080p25
640x480@75	1280x1024@60	1920x1200@60	1080p29.97
800x600@50	1280x1024@75	480i60	1080p30
800x600@60	1366x768@60	480p60	1080p50
800x600@75	1366x768@50	576i50	1080p59.94
1024x768@50	1366x768@60	576p50	1080p60
1024x768@60	1400x1050@50	720p50	2k50
1024x768@75	1400x1050@60	720p59.94	2k60
1280x768@50	1600x900@60	720p60	
1280x768@60	1600x1200@50	1080p23.976	
1280x800@60	1600x1200@60	1080p24	

12.3.2 SDI Output Resolutions

Technical Specifications of the SDI Output Signal			
480i60	720p60	1080p25	1080p50
576i50	1080p23.976	1080p29.97	1080p59.94
720p50	1080p24	1080p30	1080p60
720p59.94			

13 The VP-774AMP RS-232 Communication Protocol

The Kramer Protocol lets you control the **VP-774AMP** from any standard terminal software (for example, the Windows® HyperTerminal Application).

13.1 Using the Communication Protocol

There are three different methods to control the **VP-774AMP** via the RS-232 or the Ethernet:

- Protocol commands (via protocol 3000 or Legacy Protocol) mimicking the OSD, see [Section 13.2](#)
- The button functions mimicking the remote controller buttons (as well as the front panel buttons), see [Section 13.3](#)
- Protocol 3000 common commands, see [Section 13.4](#)



All three tables together include all the protocol commands, but they are not identical and do not always include the same information. Some of the data may appear in one or two of the tables but not in the third table and vice versa.

The protocol 3000 communications protocol uses a data rate of 115200 baud, with no parity, 8 data bits, and 1 stop bit.

The Legacy communication protocol uses a data rate of 9600 baud, with no parity, 8 data bits and 1 stop bit. CTS mode and XON/XOFF are set to Off.



Note that if the Protocol is set to Legacy (via the Miscellaneous menu, see [Section 6.8](#)), some PC applications (for example, K-Upload), as well as the Web pages may not function properly.

13.2 Communication Protocol: Mimicking OSD

The audio/video protocol commands defines all the function numbers, their valid parameters can be used with protocol 3000 or the Legacy protocol.

13.2.1 Using the Communication Protocol with Protocol 3000 (the “Y” Command)

Set Command:

Type in: “Y Control_Type=0,Function,Param”

Reply: “~id=01Y Control_Type=0,Function,Param OK”

Set command example, set window control (721) to PiP:

Send: “#y 0,721,1”

Reply: “~01@Y 0,721,1 OK”

Get Command:

Type in: “Y Control_Type=1,Function”

Result: “~id=01Y Control_Type=1,Function,Param”

Get command example: get window control setup (721):

Send: “#y 1,721”

Result: “~01@y 1,721,1”



You can add a **last parameter**, to be located fourth in SET or third in GET, to define a specific window.

For example:

Set H Sharpness value to 10 on the PiP window (1): “#y 0,510,10,1”

Get H sharpness of the Main window (0): “#y 1,510,0”

The “Y” command also supports the value increment/decrement of any command using the ‘+’ or ‘-’ signs as the third parameter of the “Y” command.

For example, move the PiP window one step to the left

Send: “#Y 0,141,-,1<CR>”

Reply: “~01@Y 0,141,-,1 OK”

For example, in order to increase zoom on the main window

Send: “#Y 0,650,+,0<CR>”

Reply: “~01@Y 0,650,+,0 OK”

13.2.2 Using the Communication Protocol with Legacy Protocol

Set Command:

Type in: Y■Control_Type■Function■Param[CR]

Reply: Z■Control_Type■Function■Param[CR][LF]

Get Command:

Type in: Y■Control_Type■Function[CR]

Reply: Z■Control_Type■Function■Param[CR][LF]

When sending a command, a blank character may precede [CR] if desired

Example:

Example 1: set brightness value as 32

Send: Y■0■410■32[CR]

Reply: Z■1■410■32[CR][LF]

Example 2: get current output resolution. (4 = SVGA)

Send: Y■1■631[CR]

Reply: Z■1■631■4[CR][LF]

Character Symbols Definitions	
Symbol	Meaning
□	Space
[CR]	Carriage Return, ASCII code 0x0D
[LF] or >	Line Feed, ASCII code 0x0A

13.2.3 Protocol Table: Mimicking OSD

You can associate a function number to its description and valid parameters intuitively by navigating the OSD menu according to the following logic:

A function number is directly related to its location in the OSD menu.

For example, the third menu on the OSD is Process (3 in the hundreds). The second menu item in Process is Film Mode (2 in the tens), therefore the function number for it will be 320 (3rd item on the Main Window Control and the 2nd item in the Process submenu (see also [Section 6.1](#)). When navigating in the OSD MENU you will be able to see the Film Mode valid parameters. The following table defines the protocol commands:

1st Level	2nd Level	3rd Level	4th Level	Range	Func.	Note	
Input	Display Mode	Single Window		0	110	Single window also displays the aspect ratio in the OSD MENU	
		Picture in Picture		1			
		Picture + Picture		2			
		Split		3			
		Customized		4			
	Input Source	HDMI1		13	120	In case the window is inactive -1 will be returned	
		HDMI2		14			
		HDMI3		10			
		HDMI4		15			
		PC1		11			
		PC2		12			
		CV		9			
		DP		16			
	Input Settings	H Image Shift			20:790	131	Volatile Parameter
			V Image Shift		4:240	132	
		Auto Positioning	Off		0	133	Not applicable to HD/SD video types
			Normal Scan		1		
			Wide Scan		2		
		HDCP Mode	On		1	134	
			Off		0		
		EDID Select	1024x768 @60		0	135	Applicable to input types with EDID only
			1280x800 @60		1		
			1280x1024 @60		2		
			1366x768 @60		3		
			1440x900 @60		4		
			1400x1050 @60		5		
			1600x900 @60		6		
			1600x1200 @60		7		
	1680x1050 @60			8			
	1920x1200 @60RB			9			
	720p50			10			
	720p60			11			
	1080p50			12			
1080p60		13					
2k50		14					
2k60		15					
<p>Note that the color depth bit is the MSB of PM.EDID_SEL (which represents the resolution). In case 8bpp is selected, set the color depth bit accordingly. For example, when selecting 1600x900@60 at 8bpp, PM.EDID_SEL = 86h=134 dec; and when selecting it at 12bpp, PM.EDID_SEL = 6h=6 dec</p> <p>Also note that the modeline bit is bit 6 of PM.EDID_SEL (which represents the resolution). In case single modeline is selected, set the modeline bit accordingly. For example, when selecting 1600x900@60 in Single modeline (12bpp), PM.EDID_SEL = 46h=70 dec; and when selecting it in Multiple modelines (12bpp), PM.EDID_SEL = 6h=6 dec</p>							

1st Level	2nd Level	3rd Level	4th Level	Range	Func.	Note		
		Color Space	RGB	0	136	Applicable to PC and HDMI inputs only		
			YPbPr	1				
			Follow Input	2				
		Auto Shift Mode	Auto	0	137			
			Semi Auto	1				
			Customized	2				
	Window Customization	H Position		0:2048	141	The value range is dynamic. The FW prevents window overlapping and exceeding of boundaries The PiP window horizontal value range is 0-1600		
		H Width		0:2048	142			
		V Position		0:2048	143			
		V Height		0:2048	144			
Audio	Volume	Input Volume		-20:4 [dB]	211	Unavailable in audio pass-through		
		Output Volume		-80:20 [dB]	212			
		Mic1 Volume		-100:12[dB]	213			
		Mic1 Volume		-100:12[dB]	214			
	Balance			-10:10 [Ratio]	220			
	Treble			-18:18 [dB]	230			
	Bass			-18:18 [dB]	240			
	Mic Effects	Mic1 Talkover Depth			0:-100 [%]		251	Unavailable in audio pass-through. Talkover is disabled in Mix mode
		Mic1 Talkover Trigger			-100:23 [dB]		252	
		Mic1 Mix			-100:1 [dB]		253	Unavailable in audio pass-through Mix mode disables talkover mode
		Line Mix			-100:0 [dB]	254	Unavailable in audio pass-through	
		Mic2 Mix			-100:1 [dB]	255	Unavailable in audio pass-through Mix mode disables talkover mode	
		Mic2 Talkover Trigger			-100:23 [dB]	256	Unavailable in audio pass-through. Talkover is disabled in Mix mode	
		Mic2 Talkover Depth			0:-100 [%]	257		
	Embedded	Pass-through	On	1	261	Unavailable for non-embedded audio		
			Off	0				
		Analog Takeover	On	1	262			
			Off	0				
	Delay	Lip Sync			0:90 [ms]	271		
		Mic1 Delay			0:40 [ms]	272		
		Mic2 Delay			0:40 [ms]	273		
Power Amplifier		Off		0	280			
		Power Level 1		1				
		Power Level 2		2				
		Power Level 3		3				
		Power Level 4		4				

1st Level	2nd Level	3rd Level	4th Level	Range	Func.	Note	
	SDI Channeling	Group A	None	0 (read only)	291		
			Activate CH1	1			
			Activate CH2	2			
			Bypass	3			
		Group B	None	0 (read only)	292		
			Activate CH1	1			
			Activate CH2	2			
			Bypass	3			
		Group C	None	0 (read only)	293		
			Activate CH1	1			
			Activate CH2	2			
			Bypass	3			
		Group D	None	0 (read only)	294		
			Activate CH1	1			
			Activate CH2	2			
			Bypass	3			
Bypassed Group	Unmute	0	295				
	Mute	1					
Process	Deinterlacing	Method	Line Doubler	0	311	Volatile parameter unavailable in progressive scan	
			Motion Adaptive	1			
		Sync	Current Field	0	312		Unavailable in progressive scan.
			Older Field	1			
	Film Mode	Off		320	Unavailable in progressive scan		
		Follow Input	1				
		24PsF Mode	2				
	Diagonal Correction			0:3	330	Unavailable in progressive scan. Unavailable when deinterlacing sync is older field	
	MD Sensitivity	LEVEL1		0	340	Unavailable in progressive scan	
		LEVEL2		1			
		LEVEL3		2			
		LEVEL4		3			
LEVEL5			4				
Picture	Brightness			-400:400	410	In the OSD menu the range appears as -80:80	
	Contrast			0.1:1.6	420		
	Color			0.1:1.6	430		
	Color Correction	Blue		0:4	441		
		Green		0:4	442		
		Flesh		0:4	443		
	Black Level			-80:80	450		
	Gamma Mode	Gamma Off		0	460		
		Gamma 0.4		1			
Gamma 0.8			2				
Gamma 1.2			3				

1st Level	2nd Level	3rd Level	4th Level	Range	Func.	Note		
		Gamma 1.6		4				
		Gamma 2.0		5				
		Gamma 2.4		6				
		Gamma 2.8		7				
	Dither	Mode0: Disable error diffusion			0	470		
		Mode1: In-frame 8:6 conversion			1			
		Mode2: Intra-frame 8:6 conversion			2			
		Mode3: In-frame 10:8 conversion			3			
		Mode4: Intra-frame 10:8 conversion			4			
		Mode5: In-frame 12:10 conversion			5			
	Mode6: Intra-frame 12:10 conversion			6				
	Auto Adjust				0:1	480	Self-clearing	
	Enhance	H Sharpness			-10:10	510		
V Sharpness				-10:10	520			
Noise Reduction		Mosquito NR			0:3	531	Unavailable in progressive scan	
		Combing NR			0:3	532		
		Temporal NR			0:3	533		
		Block NR		0:3	534	Unavailable in progressive scan		
Scale	Aspect Ratio	Follow input			0	610	1. Single window only 2. Customization lost 3. In "Follow Input", output must be bigger than input	
		Follow Output			1			
		Best Fit			2			
		Letterbox			3			
	Overscan	Off			0	620		
		5%			1			
		10%			2			
	Output	Video Resolution	Native			0	631	1. GET command in native mode returns the determined resolution of the master connection 2. Special OSD MENU screen, follow OSD instructions
			640x480@60			1		
			640x480@75			2		
			800x600@50			3		
			800x600@60			4		
			800x600@75			5		
			1024x768@50			6		
			1024x768@60			7		
1024x768@75				8				
1280x768@50				9				
1280x768@60				10				
1280x800@60				11				
1280x1024@50				12				
1280x1024@60				13				
1280x1024@75			14					
1360x768@60			15					
1366x768@50			16					
1366x768@60			17					
1400x1050@50			18					
1400x1050@60			19					

1st Level	2nd Level	3rd Level	4th Level	Range	Func.	Note		
			1600x900@60	20				
			1600x1200@50	21				
			1600x1200@60	22				
			1680x1050@60	23				
			1920x1200@60	24				
			480i60	25				
			480p60	26				
			576i50	27				
			576p50	28				
			720p50	29				
			720p59.94	30				
			720p60	31				
			1080p23.976	32				
			1080p24	33				
			1080p25	34				
			1080p29.97	35				
			1080p30	36				
			1080p50	37				
			1080p59.94	38				
			1080p60	39				
		2k50	40					
		2k60	41					
		Master Connection		HDMI1	0	632		
				HDMI2	1			
				HDBT	2			
				SDI	3			
		Deep Color		Off	0	633		
				Follow Output	1			
		Color Space		RGB	0	634	Not applicable to SDI output. Screen may flicker	
				YPbPr422	1			Not applicable to PC output. Screen may flicker
				YPbPr444	2			Not applicable to SDI output. Screen may flicker
		HDCP Mode		Follow Output	0	635		
				Follow Input	1			
		Zoom Position	H Position		0:2047	641	Value range is dynamic, FW prevents zoom from exceeding the boundaries	
			V Position		0:2047	642		
		Zoom			1.0:16.0	650		
		Factory Reset	Information	NTSC		0	710	READ ONLY: In the OSD MENU - Input, Output video formats & FW version.
				PALM		1		
				PAL60		2		
				N443		3		
				NTSC_4		4		

1st Level	2nd Level	3rd Level	4th Level	Range	Func.	Note
		SECAM		5		In the protocol – Get command – returns the Input video format only
		PAL		6		
		PALNC		7		
		NTSC_8		8		
		N/A		9		
		N/A		10		
		N/A		11		
		N/A		12		
		N/A		13		
		525p60		14		
		625p50		15		
		720p60		16		
		720p50		17		
		720p24		18		
		720p25		19		
		720p30		20		
		1080i60		21		
		1080i50		22		
		N/A		23		
		1080i100		24		
		1080p60		25		
		1080p50		26		
		1080p30		27		
		1080p23_976		28		
		1080p24		29		
		1080p25		30		
		2k50		31		
		2k60		32		
		640X480@60		33		
		N/A		34		
		N/A		35		
		N/A		36		
		640x480@72		37		
		640x480@75		38		
		848x480@60		39		
		640x480@85		40		
		N/A		41		
		800x600@56		42		
		800x600@60		43		
		N/A		44		
		800x600@72		45		
		800x600@75		46		
		800x600@85		47		
		1024x768@60		48		
		1360x768@60		49		
		1280x768@60		50		

1st Level	2nd Level	3rd Level	4th Level	Range	Func.	Note	
		1024x768@70		51			
		1024x768@75		52			
		1280x800@60		53			
		1024x768@85		54			
		1400x1050@60		55			
		1400x1050@75		56			
		1440x900@60		57			
		1152x864@75		58			
		1600x900@60		59			
		1280x1024@60		60			
		1280x1024@75		61			
		1280x960@85		62			
		1920x1200@60RB		63			
		1280x1024@85		64			
		1600x1200@60		65			
		1680x1050@60		66			
		NONE		0XF5 or 0XFF			
	OSD	Window Control	Main Win	0	721	When in the single window mode, only Main Win is valid	
			PiP Win	1			
			H Position		0:2047	722	The value range is dynamic, FW prevents exceeding of boundaries
			V Position		0:2047	723	
			Transparency	ON	1	724	
				OFF	0		
			Transparency Gain		0.1:1.6	725	
			Transparency Bias		-400:400	726	
			Blink	ON	1	727	
				OFF	0		
		Blink Period		0.1:1.6	728		
		Timeout	Off	0	729		
			30 Sec	1			
			60 Sec	2			
	Advanced	V Keystone		-400:400	731	In the OSD menu the value range shows -80:80. Unavailable for interlaced output	
		Auto Sync Off	On	1	732	Two idle minutes are required to trigger screen shutdown	
			Off	0			
		Luma Keying	On	1	733	Screen may flicker. Keying the PiP window	
			Off	0			
		Alert System	On	1	734		
			Off	0			
		No Signal	Gray	0	735		
	Blue		1				
	Black		2				

1st Level	2nd Level	3rd Level	4th Level	Range	Func.	Note
		Auto Switching	Off	0	736	Last Connected is available for HDMI and DP inputs only
			Scan	1		
			Last Connected	2		
	Pause	Freeze	On	1	741	
			Off	0		
		Blank	On	1	742	
			Off	0		
		Mute	On	1	743	In the PiP Mode, applies to main window only
			Off	0		
		Disable Outputs	On	1	744	Follow OSD instructions
			Off	0		
	Protocol	P3K		0	750	
		Legacy		1		
	Test Pattern	Off		0	760	Non-HDCP content sinusoid sound
		Slide Bar		1		
Color Bar			2			
	Including ETH			770		
	Excluding ETH			771		

13.3 Protocol Table: Mimicking Remote and Front Panel Buttons

The keystroke codes operate in the following way:

SET command third param =0,

Syntax example: "#Y 0,10,0<CR>" => MENU keystroke

GET command for keystrokes will return ERR

The following table defines the keystroke function codes:

Button	Keystroke Code	Button	Keystroke Code	Button	Keystroke Code
MENU	10	CH1_VGA1	21	CH2_HDMI1	32
ENTER	11	CH1_VGA2	22	CH2_HDMI2	33
MINUS	12	CH1_HDMI1	23	CH2_HDMI4	34
PLUS	13	CH1_HDMI2	24	CH2_DP	35
RESET	14	CH1_HDMI4	25	CH2_SDI	36
PIP	15	CH1_DP	26	MUTE	37
BLANK	16	CH1_SDI	27	POWER	38
FREEZE	17	CH2_CV1	28	LEFT	39
LOCK	18	CH2_HDMI3	29	RIGHT	40
CH1_CV1	19	CH2_VGA1			
CH1_HDMI3	20	CH2_VGA2			

13.4 The Protocol 3000 Common Operation Commands

The following table lists the protocol 3000 commands:

Operation commands		
Command	Syntax	Response
Lock front panel	LOCK-FP <u>LOCK-MODE</u>	LOCK-FP <u>LOCK-MODE</u> <u>RESULT</u>
Get front panel locking state	LOCK-FP?	LOCK-FP <u>LOCK-MODE</u>
Parameters Description: <u>LOCK-MODE</u> = Front panel locking state: "0" or "off" to unlock front panel buttons. "1" or "on" to lock front panel buttons.		
Power state	POWER <u>POWER-MODE</u>	POWER <u>POWER-MODE</u> <u>RESULT</u>
Get power state	POWER?	POWER <u>POWER-MODE</u>
Parameters Description: <u>POWER-MODE</u> = power state: "0" or "off" to enter standby mode. "1" or "on" to power up.		
Restart device	RESET	RESET OK
Peripheral firmware update execute*	UPGRADE	UPGRADE OK
Usually the firmware will upload to the device via a command such as LDFW A device reset may be needed to complete the process		
Video core Firmware update execute*	UPGRADES	UPGRADES OK
Reset configuration to factory default	FACTORY	FACTORY <u>RESULT</u>
Reset Ethernet configuration to factory default	ETH-FACTORY	ETH-FACTORY <u>RESULT</u>
SET dedicated EAS port settings	EAS-CFG <u>PORTTYPE</u> , <u>PORTNUM</u>	EAS-CFG <u>PORTTYPE</u> , <u>PORTNUM</u> <u>RESULT</u>
GET dedicated EAS port settings	EAS-CFG?	EAS-CFG <u>PORTTYPE</u> , <u>PORTNUM</u>
Parameters Description: <u>PORTTYPE</u> either "TCP" or "UDP" <u>PORTNUM</u> Ethernet port		
EAS Activation Mode notification messages	N/A	EAS-EXE <u>ACTIVATION-MODE</u> OK
Parameters Description: <u>ACTIVATION-MODE</u> = EAS notification: "1" to notify full screen + siren alert mode (Severity = Extreme) "2" to notify full screen alert mode (Severity = Severe) "3" To notify full screen alert mode (Severity = Moderate) "4" To notify message mode (Severity = Minor) "5" To notify message crawler mode (Severity = Unknown)		

Operation commands		
Command	Syntax	Response
"0" to notify that the alert went off either by timeout or by keystroke		
SET dedicated port tunneling settings	PTNL-CFG <u>PORTTYPE</u> <u>PORTNUM</u>	PTNL-CFG CFG <u>PORTTYPE</u> <u>PORTNUM</u> <u>RESULT</u>
GET dedicated port tunneling settings	PTNL-CFG?	PTNL-CFG <u>PORTTYPE</u> <u>PORTNUM</u>
Parameters Description: <u>PORTTYPE</u> either "TCP" or "UDP" <u>PORTNUM</u> Ethernet port		
SET UART port tunneling settings	UART <u>BAUD</u> <u>DATA_BITS</u> <u>PARITY</u> <u>STOPBITS</u>	UART <u>BAUD</u> <u>DATA_BITS</u> <u>PARITY</u> <u>STOPBITS</u> <u>RESULT</u>
GET UART port tunneling settings	UART?	UART <u>BAUD</u> <u>DATA_BITS</u> <u>PARITY</u> <u>STOPBITS</u>
Parameters Description: <u>BAUD</u> = 1200, 2400, 4800, 9600, 19200, 38400 57600, 115200 <u>DATA_BITS</u> = 5 to 8 inclusive <u>PARITY</u> = "NONE", "ODD", "EVEN", "MARK", "SPACE" or the first letter of these words <u>STOPBITS</u> = 1 or 2		
Audio/video common commands		
Command	Syntax	Response
Output volume	VOLUME <u>VOLUME</u> <u>PARAMETER</u>	VOLUME <u>VOLUME</u> <u>PARAMETER</u> <u>RESULT</u>
Get output volume	VOLUME?	VOLUME <u>VOLUME-VALUE</u>
Parameters Description: <u>VOLUME-PARAMETER</u> = output volume parameters: [VALUE] either positive or negative digits (minus sign precedes negative values). "+" increase current value, "-" decrease current value		
Windows customization	WIN-CUST <u>WINDOW</u> <u>HPOS</u> <u>HW</u> <u>VPOS</u> <u>VH</u>	WIN- CUST <u>WINDOW</u> <u>HPOS</u> <u>HW</u> <u>VPOS</u> <u>VH</u> <u>RESULT</u>
Parameters Description: fast window customization [WINDOW] "0" for main window; "1" for PiP window [HPOS] horizontal position value [HW] horizontal width value [VPOS] vertical position value [VH] vertical height value		
Set dual window state	PIP <u>PIP-MODE</u>	PIP <u>PIP-MODE</u> <u>RESULT</u>
Get dual window state	PIP?	PIP <u>PIP-MODE</u>
Parameters Description: <u>PIP-MODE</u> = Dual window state: "0" or "off" for single window. "1" or "on" for dual window.		

Identification commands		
Command	Syntax	Response
Protocol Handshaking	# CR	~OK CR LF
Read device model	MODEL?	MODEL MACHINE_MODEL
Read device serial number	SN?	SN SERIAL_NUMBER
Read device firmware version	VERSION?	VERSION MAJOR MINOR BUILD REVISION
Read device build date	BUILD-DATE?	BUILD-DATE YYYY/MM/DD HH:MM:SS
Read device protocol version	PROT-VER?	PROT-VER 3000: MAJOR MINOR

Command - NAME		Command Type - System (Ethernet)	
Command Name		Permission	Transparency
Set:	NAME	Administrator	Public
Get:	NAME?	End User	Public
Description	Syntax		
Set:	Set machine (DNS) name	#NAME _{SP} machine_name _{CR}	
Get:	Get machine (DNS) name	#NAME? _{CR}	
Response			
Set:	~nn@NAME _{SP} machine_name _{SP} OK _{CR} _{LF}		
Get:	~nn@NAME? _{SP} machine_name _{CR} _{LF}		
Parameters			
<i>machine_name</i> - String of up to 14 alpha-numeric chars (can include hyphen, not at the beginning or end)			
Notes			
The machine name is not the same as the model name. The machine name is used to identify a specific machine or a network in use (with DNS feature on)			

Network settings commands		
Network settings commands require admin authorization		
Command	Syntax	Response
Set IP Address	NET-IP IP_ADDRESS NTIP	NET-IP IP_ADDRESS RESULT
Read IP Address	NET-IP? NTIP?	NET-IP IP_ADDRESS
Read MAC Address	NET-MAC? NTMC?	NET-MAC MAC_ADDRESS

Network settings commands		
Network settings commands require admin authorization		
Command	Syntax	Response
Set subnet mask	NET-MASK <u>SUBNET_MASK</u> NTMSK	NET-MASK <u>SUBNET_MASK</u> <u>RESULT</u>
Read subnet mask	NET-MASK? NTMSK?	NET-MASK <u>SUBNET_MASK</u>
Set gateway address	NET-GATE <u>GATEWAY_ADDRESS</u> NTGT	NET-GATE <u>GATEWAY_ADDRESS</u> <u>RESULT</u>
Read subnet mask	NET-GATE? NTGT?	NET-GATE <u>GATEWAY_ADDRESS</u>
Set DHCP mode	NET-DHCP <u>DHCP_MODE</u> NTDH	NET-DHCP <u>DHCP_MODE</u> <u>RESULT</u>
Read subnet mask	NET-DHCP? NTDH?	NET-DHCP <u>DHCP_MODE</u>
<p><u>DHCP_MODE</u> =</p> <p>0 (factory default) – Don't use DHCP (Use IP set by factory or IP set command). 1 – Try to use DHCP, if unavailable use IP as above. 2– Try to use DHCP, if unavailable use AUTO-IP as described here: http://support.microsoft.com/kb/q307287/.</p> <p>After setting DHCP_MODE to 1 or 2 you need to reset the device</p>		
Change protocol Ethernet port	ETH-PORT <u>PROTOCOL</u> , <u>PORT</u>	ETH-PORT <u>PROTOCOL</u> <u>PORT</u> <u>RESULT</u>
Read protocol Ethernet port	ETH-PORT? <u>PROTOCOL</u>	ETH-PORT <u>PROTOCOL</u> , <u>PORT</u>
<p><u>PROTOCOL</u> = TCP / UDP (transport layer protocol) <u>PORT</u> =</p> <p>Ethernet port to enter protocol 3000 commands. 1-65535 = User defined port 0 - reset port to factory default (50000 for UDP, 5000 for TCP)</p>		
Load new peripheral firmware P	Step 1: LDFW <u>SIZE</u> Response 1: READY or LDFW <u>SIZE</u> <u>ERR###</u> Step 2: If ready was received, send <u>FIRMWARE_DATA</u> ^P Response 2: LDFW <u>SIZE</u> <u>RESULT</u>	
Load new video core firmware	Step 1: LDFWS <u>SIZE</u> Response 1: READY or LDFWS <u>SIZE</u> <u>ERR###</u> Step 2: If ready was received, send <u>FIRMWARE_DATA</u> ^P Response 2: LDFWS <u>SIZE</u> <u>RESULT</u>	
Load new audio/graphic memory file	Step 1: LDMFS <u>SIZE</u> Response 1: READY or LDMFS <u>SIZE</u> <u>ERR###</u> Step 2: If ready was received, send <u>FIRMWARE_DATA</u> ^P Response 2: LDMFS <u>SIZE</u> <u>RESULT</u>	

LIMITED WARRANTY

The warranty obligations of Kramer Electronics for this product are limited to the terms set forth below:

What is Covered

This limited warranty covers defects in materials and workmanship in this product.

What is Not Covered

This limited warranty does not cover any damage, deterioration or malfunction resulting from any alteration, modification, improper or unreasonable use or maintenance, misuse, abuse, accident, neglect, exposure to excess moisture, fire, improper packing and shipping (such claims must be presented to the carrier), lightning, power surges, or other acts of nature. This limited warranty does not cover any damage, deterioration or malfunction resulting from the installation or removal of this product from any installation, any unauthorized tampering with this product, any repairs attempted by anyone unauthorized by Kramer Electronics to make such repairs, or any other cause which does not relate directly to a defect in materials and/or workmanship of this product. This limited warranty does not cover cartons, equipment enclosures, cables or accessories used in conjunction with this product.

Without limiting any other exclusion herein, Kramer Electronics does not warrant that the product covered hereby, including, without limitation, the technology and/or integrated circuit(s) included in the product, will not become obsolete or that such items are or will remain compatible with any other product or technology with which the product may be used.

How Long Does this Coverage Last

Seven years as of this printing; please check our Web site for the most current and accurate warranty information.

Who is Covered

Only the original purchaser of this product is covered under this limited warranty. This limited warranty is not transferable to subsequent purchasers or owners of this product.

What Kramer Electronics will do

Kramer Electronics will, at its sole option, provide one of the following three remedies to whatever extent it shall deem necessary to satisfy a proper claim under this limited warranty:

1. Elect to repair or facilitate the repair of any defective parts within a reasonable period of time, free of any charge for the necessary parts and labor to complete the repair and restore this product to its proper operating condition. Kramer Electronics will also pay the shipping costs necessary to return this product once the repair is complete.
2. Replace this product with a direct replacement or with a similar product deemed by Kramer Electronics to perform substantially the same function as the original product.
3. Issue a refund of the original purchase price less depreciation to be determined based on the age of the product at the time remedy is sought under this limited warranty.

What Kramer Electronics will not do Under This Limited Warranty

If this product is returned to Kramer Electronics or the authorized dealer from which it was purchased or any other party authorized to repair Kramer Electronics products, this product must be insured during shipment, with the insurance and shipping charges prepaid by you. If this product is returned uninsured, you assume all risks of loss or damage during shipment. Kramer Electronics will not be responsible for any costs related to the removal or re-installation of this product from or into any installation. Kramer Electronics will not be responsible for any costs related to any setting up this product, any adjustment of user controls or any programming required for a specific installation of this product.

How to Obtain a Remedy under this Limited Warranty

To obtain a remedy under this limited warranty, you must contact either the authorized Kramer Electronics reseller from whom you purchased this product or the Kramer Electronics office nearest you. For a list of authorized Kramer Electronics resellers and/or Kramer Electronics authorized service providers, please visit our web site at www.kramerelectronics.com or contact the Kramer Electronics office nearest you.

In order to pursue any remedy under this limited warranty, you must possess an original, dated receipt as proof of purchase from an authorized Kramer Electronics reseller. If this product is returned under this limited warranty, a return authorization number, obtained from Kramer Electronics, will be required. You may also be directed to an authorized reseller or a person authorized by Kramer Electronics to repair the product.

If it is decided that this product should be returned directly to Kramer Electronics, this product should be properly packed, preferably in the original carton, for shipping. Cartons not bearing a return authorization number will be refused.

Limitation on Liability

THE MAXIMUM LIABILITY OF KRAMER ELECTRONICS UNDER THIS LIMITED WARRANTY SHALL NOT EXCEED THE ACTUAL PURCHASE PRICE PAID FOR THE PRODUCT. TO THE MAXIMUM EXTENT PERMITTED BY LAW, KRAMER ELECTRONICS IS NOT RESPONSIBLE FOR DIRECT, SPECIAL, INCIDENTAL OR CONSEQUENTIAL DAMAGES RESULTING FROM ANY BREACH OF WARRANTY OR CONDITION, OR UNDER ANY OTHER LEGAL THEORY. Some countries, districts or states do not allow the exclusion or limitation of relief, special, incidental, consequential or indirect damages, or the limitation of liability to specified amounts, so the above limitations or exclusions may not apply to you.

Exclusive Remedy

TO THE MAXIMUM EXTENT PERMITTED BY LAW, THIS LIMITED WARRANTY AND THE REMEDIES SET FORTH ABOVE ARE EXCLUSIVE AND IN LIEU OF ALL OTHER WARRANTIES, REMEDIES AND CONDITIONS, WHETHER ORAL OR WRITTEN, EXPRESS OR IMPLIED. TO THE MAXIMUM EXTENT PERMITTED BY LAW, KRAMER ELECTRONICS SPECIFICALLY DISCLAIMS ANY AND ALL IMPLIED WARRANTIES, INCLUDING, WITHOUT LIMITATION, WARRANTIES OF MERCHANTABILITY AND FITNESS FOR A PARTICULAR PURPOSE. IF KRAMER ELECTRONICS CANNOT LAWFULLY DISCLAIM OR EXCLUDE IMPLIED WARRANTIES UNDER APPLICABLE LAW, THEN ALL IMPLIED WARRANTIES COVERING THIS PRODUCT, INCLUDING WARRANTIES OF MERCHANTABILITY AND FITNESS FOR A PARTICULAR PURPOSE, SHALL APPLY TO THIS PRODUCT AS PROVIDED UNDER APPLICABLE LAW.

IF ANY PRODUCT TO WHICH THIS LIMITED WARRANTY APPLIES IS A "CONSUMER PRODUCT" UNDER THE MAGNUSON-MOSS WARRANTY ACT (15 U.S.C.A. §2301, ET SEQ.) OR OTHER APPLICABLE LAW, THE FOREGOING DISCLAIMER OF IMPLIED WARRANTIES SHALL NOT APPLY TO YOU, AND ALL IMPLIED WARRANTIES ON THIS PRODUCT, INCLUDING WARRANTIES OF MERCHANTABILITY AND FITNESS FOR THE PARTICULAR PURPOSE, SHALL APPLY AS PROVIDED UNDER APPLICABLE LAW.

Other Conditions

This limited warranty gives you specific legal rights, and you may have other rights which vary from country to country or state to state.

This limited warranty is void if (i) the label bearing the serial number of this product has been removed or defaced, (ii) the product is not distributed by Kramer Electronics or (iii) this product is not purchased from an authorized Kramer Electronics reseller. If you are unsure whether a reseller is an authorized Kramer Electronics reseller, please visit our Web site at www.kramerelectronics.com or contact a Kramer Electronics office from the list at the end of this document.

Your rights under this limited warranty are not diminished if you do not complete and return the product registration form or complete and submit the online product registration form. Kramer Electronics thanks you for purchasing a Kramer Electronics product. We hope it will give you years of satisfaction.



For the latest information on our products and a list of Kramer distributors, visit our Web site where updates to this user manual may be found.

We welcome your questions, comments, and feedback.

Web site: www.kramerelectronics.com

E-mail: info@kramerel.com



SAFETY WARNING

Disconnect the unit from the power supply before opening and servicing



P/N: 2900-300324



Rev: 2