

# SB-5669CKP

16x16 HDMI & HDBaseT™ 4K2K Over Single CAT5e/6/7  
Matrix Routing Switch with PoH (Power Over HDBaseT™)



### IMPORTANT WARRANTY INFORMATION.

*If you remove the HDMI screw posts, you must use the provided HDMI Locking Post replacement screws to keep the internal HDMI jack secure. Removing the HDMI screws without installing the HDMI Locking Post replacement screws will void your warranty.*



## SAFETY INFORMATION



1. To ensure the best results from this product, please read this manual and all other documentation before operating your equipment. Retain all documentation for future reference.
2. Follow all instructions printed on unit chassis for proper operation.
3. To reduce the risk of fire, do not spill water or other liquids into or on the unit, or operate the unit while standing in liquid.
4. Make sure power outlets conform to the power requirements listed on the back of the unit. Keep unit protected from rain, water and excessive moisture.
5. Do not attempt to clean the unit with chemical solvents or aerosol cleaners, as this may damage the unit. Dust with a clean dry cloth.
6. Do not use the unit if the electrical power cord is frayed or broken. The power supply cords should be routed so that they are not likely to be walked on or pinched by items placed upon or against them, paying particular attention to cords and plugs, convenience receptacles, and the point where they exit from the appliance.
7. Do not force switched or external connections in any way. They should all connect easily, without needing to be forced.
8. Always operate the unit with the AC ground wire connected to the electrical system ground. Precautions should be taken so that the means of grounding of a piece of equipment is not defeated.
9. AC voltage must be correct and the same as that printed on the rear of the unit. Damage caused by connection to improper AC voltage is not covered by any warranty.
10. Turn power off and disconnect unit from AC current before making connections.
11. Never hold a power switch in the "ON" position.
12. This unit should be installed in a cool dry place, away from sources of excessive heat, vibration, dust, moisture and cold. Do not use the unit near stoves, heat registers, radiators, or other heat producing devices.
13. Do not block fan intake or exhaust ports. Do not operate equipment on a surface or in an environment which may impede the normal flow of air around the unit, such as a bed, rug, carpet, or completely enclosed rack. If the unit is used in an extremely dusty or smoky environment, the unit should be periodically "blown free" of foreign dust and matter.
14. To reduce the risk of electric shock, do not remove the cover. There are no user serviceable parts inside. Refer all servicing to qualified service personnel. There are no user serviceable parts inside.
15. When moving the unit, disconnect input ports first, then remove the power cable; finally, disconnect the interconnecting cables to other devices.
16. Do not drive the inputs with a signal level greater than that required to drive equipment to full output.
17. The equipment power cord should be unplugged from the outlet when left unused for a long period of time.
18. Save the carton and packing material even if the equipment has arrived in good condition. Should you ever need to ship the unit, use only the original factory packing.
19. Service Information Equipment should be serviced by qualified service personnel when:
  - A. The power supply cord or the plug has been damaged.
  - B. Objects have fallen, or liquid has been spilled into the equipment.
  - C. The equipment has been exposed to rain.
  - D. The equipment does not appear to operate normally, or exhibits a marked change in performance.
  - E. The equipment has been dropped, or the enclosure damaged.

# TABLE OF CONTENTS

## HDMI-HDBaseT™ 4K2K Matrix Routing Switch Series

Thank you for purchasing the SB-5669CKP HDMI-HDBaseT™ Matrix Switcher. You will find this unit easy to install and highly reliable but it is essential that you read this manual thoroughly before attempting to use the 16x16 HDMI-HDBaseT™ Matrix switcher.

### CONTENTS

INTRODUCTION .....	1
FEATURES.....	2
PACKAGE CONTENTS .....	2
SPECIFICATIONS.....	3
FRONT PANEL .....	4
BACK PANEL .....	8
HDBASET™ I/O TRANSMISSION & CABLE EXTENSION LENGTHS.....	12
REMOTE CONTROL .....	13
IR REMOTE CODE LIST .....	14
ROOM IR REMOTE CODES .....	17
RS-232 / ETHERNET PROTOCOL .....	19
EDID FUNCTIONS .....	20
IR EXTENDER .....	27
TYPICAL APPLICATIONS .....	28
HDBASET™ APPLICATION .....	32

### INTRODUCTION

The SB-5669CKP is a professional 16x16 matrix routing switch. Supporting (16) HDMI Inputs and (16) HDMI Outputs & (16) HDBaseT™ Outputs with PoH. The SB-5669CKP is based on the HDBaseT™ standards and supports full resolution HDMI video with embedded HDCP, RS-232 and Bi-directional IR all over a single CAT6/6a/7 category cable. With a signal bandwidth of 340Mhz, there is no signal degradation. High definition digital signals can be selected and distributed to any of the (16) Inputs to any of the (32) Outputs simultaneously (channel outputs mirrored). The switcher is fully CEC, HDCP 1.3, HDMI1.4a certified with HDMI 4K2K@30Hz, DVI 1.0, 3D formats and a wide frequency range of 25MHz~340MHz. Supports UXGA/WUXGA/DVI 1920x1200 resolutions to any HD display. The SB-5669CKP has (16) HDMI connector Inputs and (16) HDBaseT™ (PoH) & (16) HDMI Outputs, effectively making this a (16) In by (32) Out switcher (same signal on both outputs). Using the HDBaseT™ output remote transmitter, it will allow you to connect a source in a remote location. Likewise, the HDBaseT™ Output and our HDBaseT™ receiver, allows you to connect a display in a remote location. EDID management can be selected between (7) different modes. Control is provided via front panel push buttons, IR remote, RS-232 or TCP/IP (not a web-browser). A RS-232 Windows GUI interface is provided for matrix routing control (Windows only).

### SAFETY PRECAUTIONS

Please read all instructions before attempting to unpack, install or operate this equipment and before connecting the power supply. Please keep the following in mind as you unpack and install this equipment:

- Always follow basic safety precautions to reduce the risk of fire, electrical shock and injury to persons.
- To prevent fire or shock hazard, do not expose the unit to rain, moisture or install this product near water.
- Never spill liquid of any kind on or into this product.
- Never push an object of any kind into this product through any openings or empty slots in the unit, as you may damage parts inside the unit.
- Do not attach the power supply cabling to building surfaces.
- Use only the supplied power supply unit (PSU). Do not use the PSU if it is damaged.
- Do not allow anything to rest on the power cabling or allow any weight to be placed upon it or any person walk on it.
- To protect the unit from overheating, do not block any vents or openings in the unit housing that provide ventilation and allow for sufficient space for air to circulate around the unit.

### DISCLAIMERS

The information in this manual has been carefully checked and is believed to be accurate. We assume no responsibility for any infringements of patents or other rights of third parties which may result from its use.

We assume no responsibility for any inaccuracies that may be contained in this document. We make no commitment to update or to keep current the information contained in this document.

We reserve the right to make improvements to this document and/or product at any time and without notice.

### COPYRIGHT NOTICE

No part of this document may be reproduced, transmitted, transcribed, stored in a retrieval system, or any of its part translated into any language or computer file, in any form or by any means — electronic, mechanical, magnetic, optical, chemical, manual, or otherwise — without express written permission and consent.

© Copyright 2016. All Rights Reserved.  
Version 1.2 JULY 2016

### TRADEMARK ACKNOWLEDGMENTS

All products or service names mentioned in this document may be trademarks of the companies with which they are associated.



# FEATURES & CONTENTS

## FEATURES

Based on HDBaseT™, bi-directional IR and RS-232 interface. Full resolution HD Video, all HDBaseT™ signals and PoH over single CAT6/6a/7 category cable.

- Enables switching of (16) HDMI digital source devices to (16) HDMI devices and (16) HDBaseT™ Transmitter Outputs (PoH) to (32) total destinations
- HDBaseT™ specifications with Bi-Directional IR, RS-232, Multi audio format and HD video signals over single CAT6/6a/7 category cable
- HDMI digital video w/ embedded HDCP, DVI format and CEC/HDCP 2.0 compliant
- Worldwide EDID control modes for HDMI full 4K2K HD Video resolutions
- Wide frequency range of 25MHz ~ 340MHz, Supports HDMI 4K2K@30Hz, HDMI 1.4a
- Wide range of HD resolutions from PC XGA to WUXGA 1920x1200 and HDTV/DTV HDMI resolutions 480i/480p, 576i/576p, 720p, 1080i/p & 4K2K (24/30Hz)
- Compatible with all HDMI source devices, PC monitors, Plasma HD displays, HDTVs and audio receivers or audio amplifiers
- Digital video TMDS formats resolutions up to 4K2K with Deep color 36-bit
- Digital audio support digital multi-channel audio: Dolby TrueHD, Dolby Digital, Dolby Digital Plug/ex, DTS, DTS-HD, DTS-HD Master, DTS-EX, PCM, PCM2, LPCM2
- HDBaseT™ supports IR remotes and RS-232 signals over a single CAT6/6a/7 category cable
- Various User Interface Controls:
  - Windows based GUI control via RS-232 port interface WIN2000/XP/WIN7-32/WIN7-64
  - Front panel push buttons
  - IR wireless remote controls
  - Ethernet switch control (via pc protocol COMMANDS)
  - Third party RS-232 control (via simple ASCII)
- Supports (7) world wide control function keys: Full function front panel controls: ALL / OFF / EDID / LOCK / RECALL / MEMORY / ENTER
- Supports EDID modes:
  - a. Embedded EDID Modes: FSS (Fast Speed Start) / H24-3D/ H24-3D-M/ H36-3D/ H36-3D-M/ 4K2K-3D / DVI-D 1920x1200-60Hz
  - b. External Modes: Learning mode (learning destination EDID link to source device)
- Automatic scanning input & output status via LCM showout on front panel
- Using the build-in booster, each HDMI Output port is capable of driving cable lengths of 1080p up to 98 ft (30M) & 4K2K up to 66 ft (20M)
- Supports IR remotes and IR extenders for a distance of up to ~ 984 ft (300M) Maximum
- Supports universal power adaptor AC100V~AC240V, 50/60Hz

The switcher will remember that last state during a power cycle. When power is removed and resorted, the last configuration will be invoked.

## PACKAGE CONTENTS

Check that you have the following components:

- SB-5669CKP Matrix Switcher (Power Over HDBaseT™)
- RS-232 V2.0 / Ethernet V1.0 Protocol Instructions
- IR Remote Control (SW-5669)
- (16) Individual Remote Controls (SW-5669CK-IR01~IR16)
- 19 inch Ear mount bracket (Part # 4U-440L)
- SB-100 IR Extender Receiver Set
- CD Contents: This manual, Windows GUI, ISP V1.0 Windows driver
- RS-232 Cable 6.5 feet (2M)
- HDMI Locking Post Replacement Screws
- Users Guide
- Worldwide Universal Power Supply 100~240VAC, AC 50/60Hz
- *Optional: SB-100C IR Extender Receiver Cable (6.5ft (2M))*

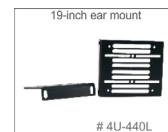

**SB-6335R series HDBaseT™ Receiver sold separately**



# SPECIFICATIONS

## SPECIFICATIONS

---

- **Type of HDMI Switcher:** (16) HDMI Inputs to (16) HDMI & (16) HDBaseT™ Outputs Matrix Switcher
- **HDMI Supports:** HDMI 4K2K@30Hz, 1080p@60Hz, H36-bit Deep color, 3D, HDMI V1.4 formats
- **HDBaseT™ Support:** HDMI digital signals, bi-directional IR, RS-232 and PoE over single CAT6/6a/7 cable
- **HDCP/CEC Support:** HDCP 1.3 Compliant, CEC Compliant
- **Video Bandwidth:** Double Data Rates: 340Mhz
- **Digital Video Support:** HD: 480i/ 480p/ 720p/ 1080i/p and 4K2K up to 36bit deep color
- **Inputs (HDMI):** (16) HDMI (HDMI or DVI digital source)
- **Outputs (HDMI):** (16) HDMI (to destination)
- **Booster (Each HDMI Output):** 1080p up to ~98 feet (30M) & 4K2K up to ~66 feet (20M)
- **HDBaseT™ Output (PoE):** (16) HDBaseT™ Transmitter (PoE) via a single category cable using RJ-45 connectors
- **HDMI Digital Multi-Channel Audio Support:** Multi Audio Formats 5.1 / 7.1, MAT(MLP), Dolby Digital, Dolby TrueHD, Dolby Digital Plus, DTS, DTS-ES 6CH, DTS-HD, DTS-HD-HRA, DTS-HD Master, (PCM-2CH)
- **HDBaseT™ Control:**
  - **1. IR Control:**
    - (16) IR In (Sends IR signals to (16) rooms via a HDBaseT™ Transmitter)
    - (16) IR Out (Links to receive IR signals from (16) rooms via a HDBaseT™ Extender)
  - **2. RS-232 I/O Control:** (16) RS-232 I/O (Controls (16) rooms with RS-232 via the switchers HDBaseT™ Extender Tx)
- **Switch Controls:**
  - Select & Function buttons on front panel (Data status via LCM panel show out)
  - IR Remote Control (switch control) (p/n: SW-HD69CK)
  - (16) IR Room Remote Controls (switch control) (p/n: SW-HD69CK01~16)
  - IR External port (switch control via 3.5mm OD Jack)
  - RS-232 series interface (switch control)
  - Ethernet series interface (switch control)
- **Source Status:** Input status LEDs indicates presence of a live signal
- **(39) Function Control Keys:** 1. ALL, 2. OFF, 3. RECALL, 4. ENTER, 5. MEMORY, 6. LOCK, 7. EDID, 8. Destination 1 thru 16, 9. Source 1 thru 16
- **(7) EDID Management:** Select Embedded EDID Modes: Mode1: Fast Speed Start®, Mode2: H24-3D, Mode3: H24-3D-M, Mode4: H36-3D, Mode5: H36-3D-M, Mode6: 4K2K-3D, PCM-2CH, Mode7: DVI-D 1920x1200
- **Learning Mode:**
  - 1. Select LEARNING mode-1: Learning single Destination EDID to Link Source
  - 2. Select LEARNING mode-2: Learning multiple Destination EDID to Link Source
- **Infrared Frequency:** 38Khz
- **IR External Distance:** SB-100 (~984 feet / 300M maximum)
- **HDBaseT™ Extender Distance:** ~328 feet / 100M maximum
- **HDMI I/O Connector:** HDMI Type A - SMD 19pin female type
- **Temperature:** Operating Temperature 32°F - 100°F (0°C - 32°C)
- **Dimensions (LxWxH):** 17.5 x 12 x 7 in
- **Rack Mount:** 4RU High 19 in Rack Mount #4U-440L (with rack mount ears)
- **Power Supply:** AC 100~240VAC 50/60Hz (120V/3A/360W; 220V/1.63A/360W)
- **Safety Approvals:** CE, FCC, REACH
- **Weight:** 16.8 lb (Unit only) / 32.0 lb (Net)

As product improvements are continuous, specifications are subject to change and without notice.



## **LOOK A PUPPY!! NOW READ THIS!!** **IMPORTANT WARRANTY INFORMATION.**

*If you remove the HDMI screw posts, you must use the provided HDMI Locking Post replacement screws to keep the internal HDMI jack secure. Removing the HDMI screws without installing the HDMI Locking Post replacement screws will void your warranty.*

# FRONT PANEL

## FRONT PANEL

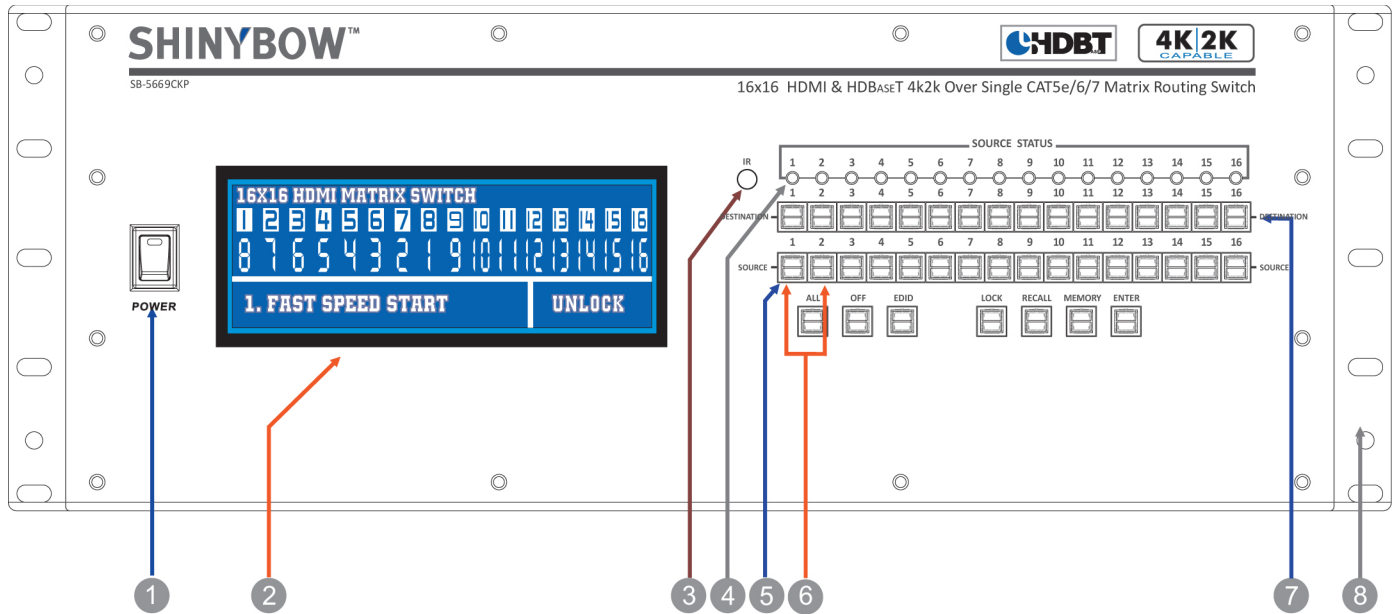

**1. POWER ON SWITCH:** The power switch turns the unit on and off. The LCM will illuminate blue to indicate the switcher is ON and receiving power. The switcher will remember the last setting during a power cycle. When power is removed and resorted, the last configuration will be evoked.

**2. STATUS DISPLAY:** Front panel status display shows current matrix routing configuration. This same display also shows particular configuration settings depending on your current function. In run mode (as shown above), the display shows each Output (destination) channel and which input (source) it is assigned.

**3. IR SENSOR:** The IR sensor receives IR commands from the supplied remote control or a third party IR emitter.

**4. INPUT STATUS DISPLAY:** Input sources 1 to 16 LED illuminates blue to indicate that a video source is present on that input.

**5. SOURCE SELECT BUTTONS:** Separate inputs 1 thru 16 select buttons are provided each source selection.

**6. EDID MODE SELECT BUTTONS:** Used to select EDID mode using buttons Source button #1 or #2.

**7. DESTINATION SELECT BUTTONS:** Separate outputs 1 thru 16 select buttons are provided for each destination assignment. Routing can be source to destination or one source to multiple destinations.

**Example:** Press Destination 1, 8, 12 then press Source 2. This will route Input 2 to Output 1, 8, 12 respectively.

**8. 19 INCH EAR MOUNT PAIR:** Converts desktop to 19 inch rack mount. Bracket (part # 4U-440L) INCLUDED. Image shows rack mount bracket attached.

# FRONT PANEL

## FRONT PANEL

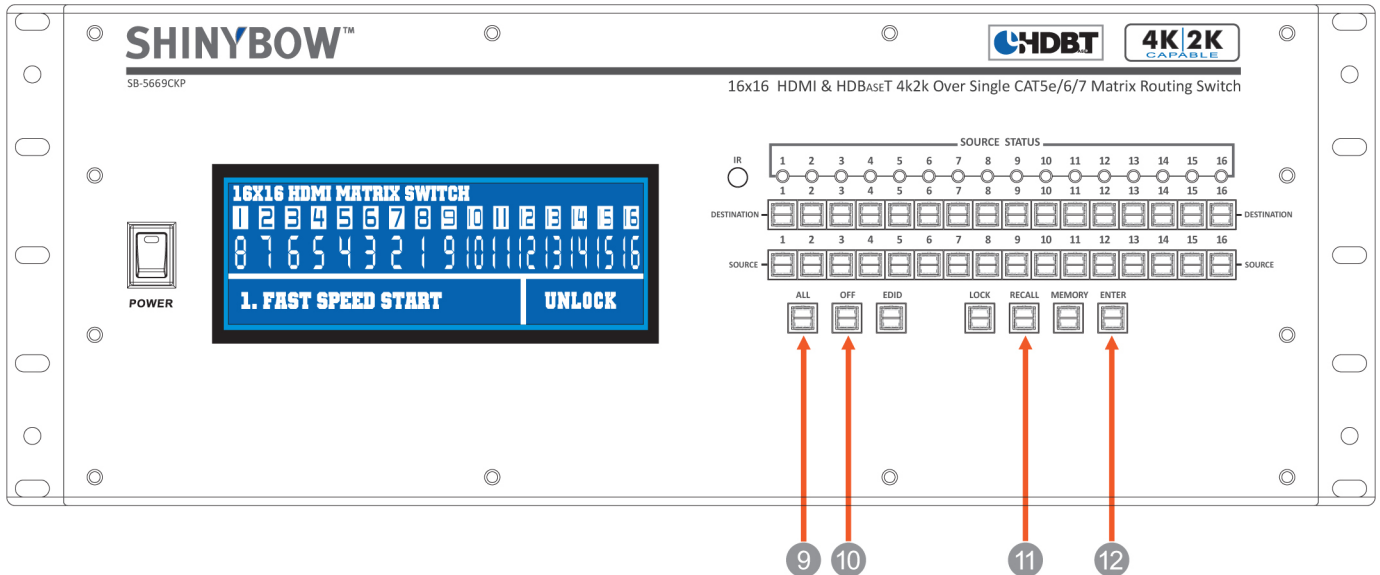

### 9. FUNCTION KEY - ALL:

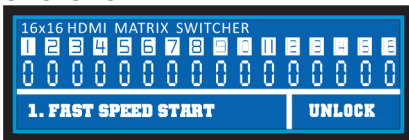

Disables (mutes) video on all destinations OR assigns the same source to all destinations.

#### Option 1

- Press **ALL** followed by **OFF** button. The display will show "0" to indicate none of the destinations are assigned a video source.

#### Option 2

- Press **ALL** followed by Source **1 THRU 16**. The display will show the source selected.
- Press **ENTER**. The pre-set source selection will be assigned all destinations.

### 10. FUNCTION KEY - OFF:

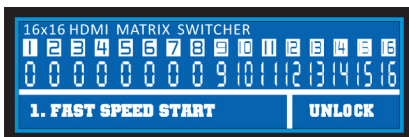

Disables (mutes) video on the selected destinations.

- Press **OFF** button followed by any Destination channel.
- Press **1 THRU 16** output destination. The display will show "0" for the selected channel, indicating no video selected.
- Press **ENTER**. The pre-set configuration will execute.

### 11. FUNCTION KEY - RECALL:

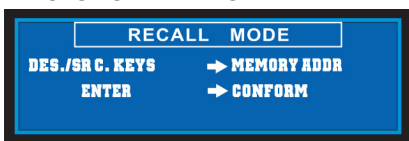

The system will show previously stored presets, up to a total of (32). Presets are stored in local memory using Source keys 1 thru 16 or Destination keys 1 thru 16 as the memory preset location.

- Press **RECALL** button.
- Press **1 THRU 16** on either Source or Destination row.
- Press **ENTER**. The pre-set configuration will execute.

Operation completes.

**Note: Operation will abort if no keys are pressed within 5 seconds.**

- Or press **RECALL** again to cancel the operation.

**12. FUNCTION KEY - ENTER:** Press **ENTER** to confirm entries.



# FRONT PANEL

## FRONT PANEL

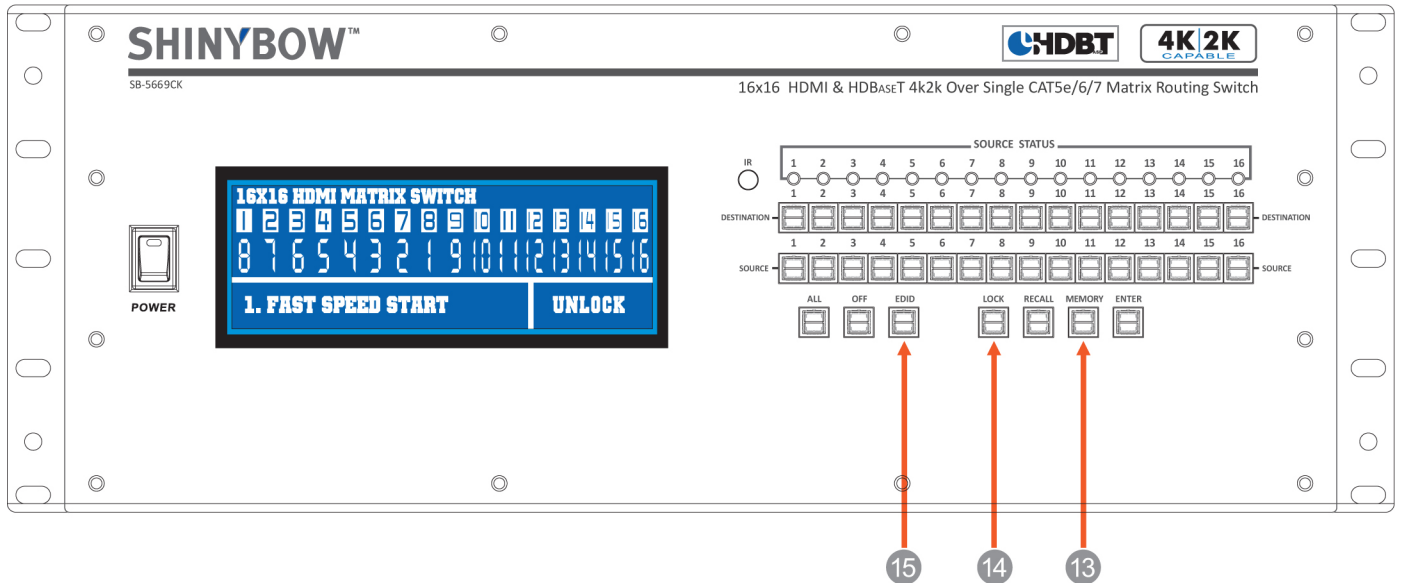

### 13. FUNCTION KEY - MEMORY:

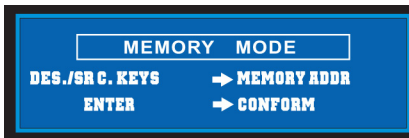

The system will show stored presets, up to a total of (32). Presets are stored in local memory using Source keys 1 thru 16 or Destination keys 1 thru 16 as the memory preset location.

- Configure desired matrices.
- Press **MEMORY** button.
- Press **1 THRU 16** on either Source or Destination row.
- Press **ENTER** to ready memory location.
- Or press **MEMORY** again to cancel operation.

Operation completes.

**Note: Operation will abort if no keys are pressed within 5 seconds.**

- Or press **MEMORY** again to cancel the operation.

### 14. FUNCTION KEY - LOCK:



- Press and hold **LOCK** button for two seconds lock out the front panel.
- Press and hold **LOCK** button for two seconds to enable the front panel.



### 15. FUNCTION KEY - EDID:

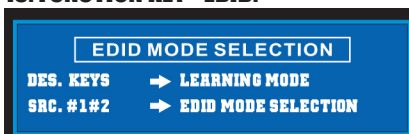

- Press **EDID** to begin setting up your EDID mode. Use source row buttons #1 and #2 to cycle thru the options. (Go to EDID setup instructions.)

# FRONT PANEL

## FRONT PANEL

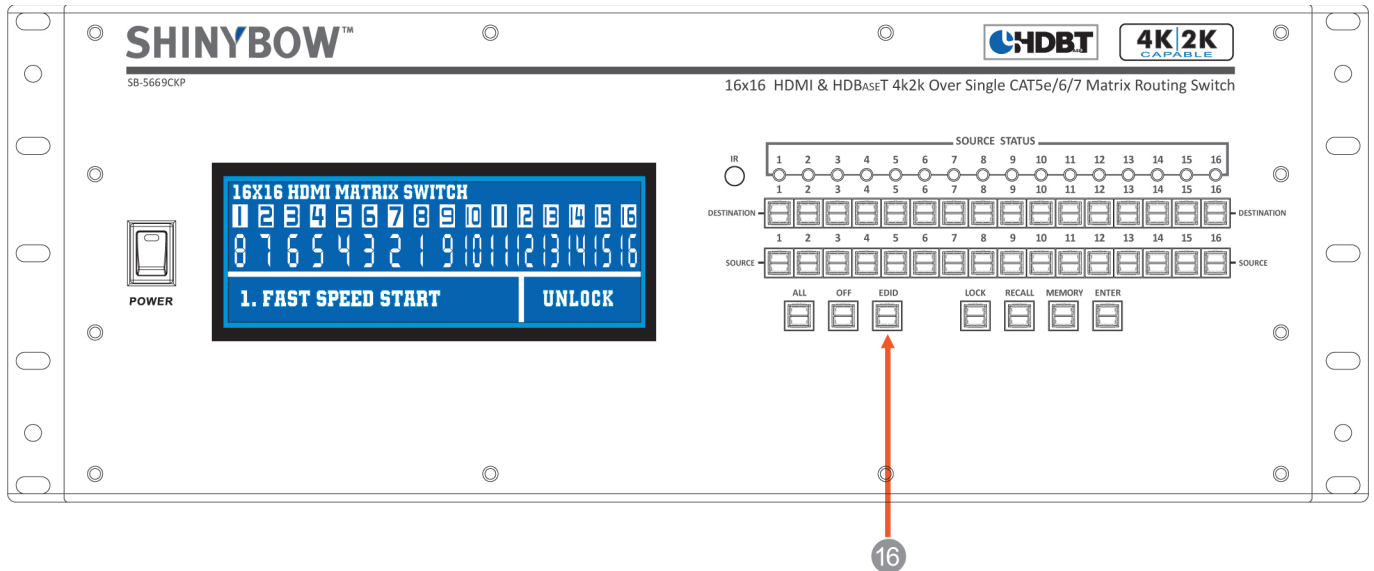

### 16. SELECT (7) EMBEDDED EDID MODES:



Used to display/change current EDID mode.

- Press **EDID** to select new EDID mode.
- Press **SOURCE** row #1 or #2. Select **(7) Embedded EDID modes**.
- Press **ENTER** to ready memory location.
- Or press **EDID** again to cancel the operation.

Operation completes.

**Note: Operation will abort if no keys are pressed within 5 seconds.**

### SELECT LEARNING MODE-#1:

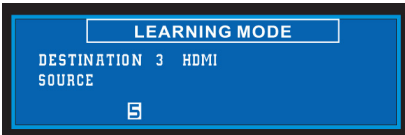

Select external **LEARNING** EDID mode-#1 (Single mode)

- Press **EDID** to select new Learning EDID mode-#1.
- Press **DESTINATION** again, press the same Destination **#1 THRU #16** to learn the HDBaseT™ EDID out port. The EDID for HDBaseT™ (CATx) has been learned.
- Press **SOURCE**, Press Source row **#1 THRU #16**. The switcher will learn the HDMI or HDBaseT™ EDID destination and pass to the select sources.
- Press **ENTER** to ready memory location.
- Or press **EDID** again to cancel the operation.

Operation completes.

**Note: Operation will abort if no keys are pressed within 5 seconds.**

### SELECT LEARNING MODE-#2:

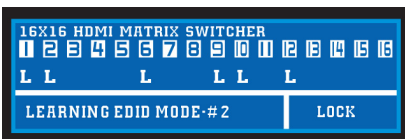

Select external **LEARNING** EDID mode-#2 (Multiple mode)

- Press **EDID** to select new Learning EDID mode-#2.
- Press **OFF**, the LCM show Learning mode #2 status.
- Press **DESTINATION** button **#1 THRU #16** to setup learning mode-#2. The LCM will show "L". The HDMI or HDBaseT™ EDID destination for (CATx) has been learned.
- Press **ENTER** to ready memory location.
- Or press **EDID** again to cancel the operation.

Operation completes.

**Note: Operation will abort if no keys are pressed within 5 seconds.**

# BACK PANEL

## BACK PANEL

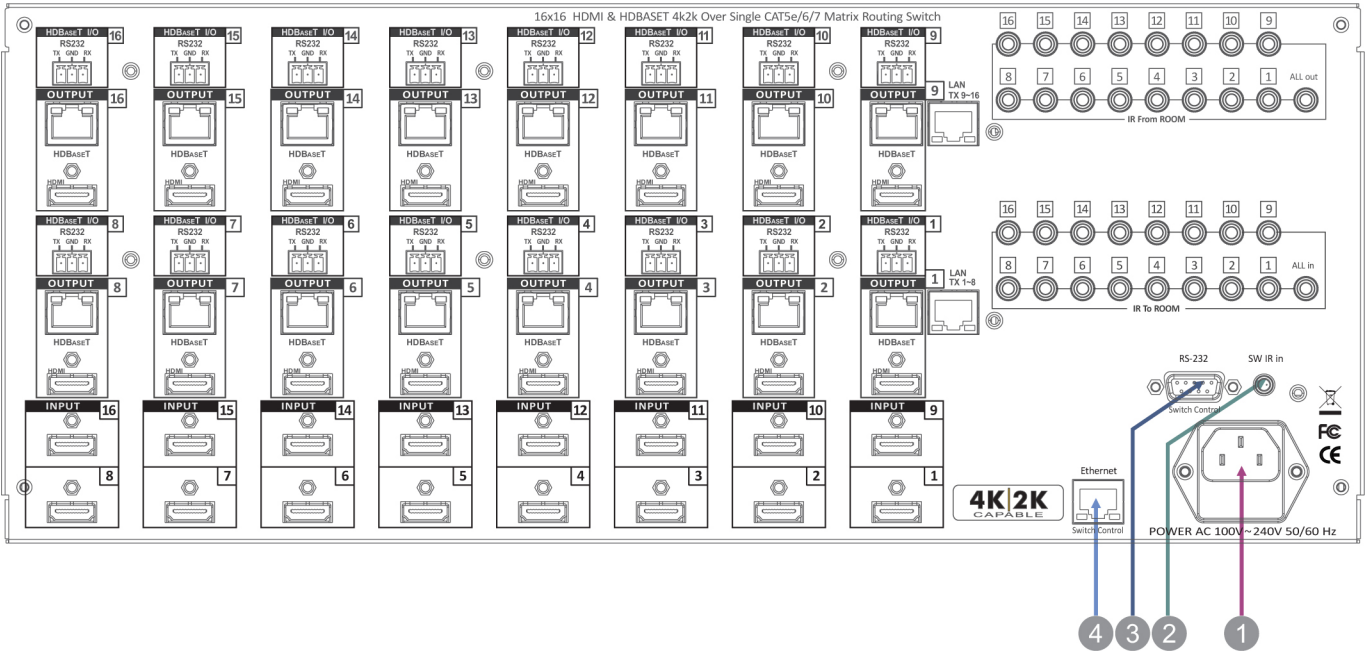

**1. DC POWER INLET:** The switcher is fitted with a AC power plug input connector. Ensure that the plug used is of an approved type and is of sufficient current carrying connector capacity with the correct voltage and connector polarity. 100~240Volt AC, 50/60Hz power supply.

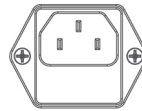

**POWER SOCKET:** Connector Type: IEC 60320 C13

**2. IR EXTENDER CONTROL:** Supports one IR extender. Extends a maximum distance of up to ~984 feet/300M. When you plug the external IR extender into the switcher, the front panel IR receiver remains active.

SW IR in



Switch Control

**IR EXTENDER JACK:** Female jack - inner OD Ø 3.5mm

**3. RS-232 CONNECTION:** RS-232 control port allows for interfacing to a PC, such as a computer or touch panel control, to the switcher via the DB-9pin female connector for serial RS-232 control.

RS232

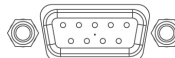

Switch Control

**REMOTE PORT:** DB-9pin female connector

**4. ETHERNET CONNECTION:** ETHERNET control port allows for TCP/IP interfacing to a PC, such as a computer or touch panel control (not a web-browser), to the switcher via the RJ-45 female connector to control the switcher.

Ethernet

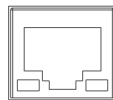

Switch Control

**REMOTE PORT:** Control the switcher via the RJ-45 female connector

**ETHERNET PORT:**

**Note:** The Ethernet port and RS-232 port cannot be used simultaneously. Any connection to the Ethernet port will disable serial commands sent to the RS-232 port.



# BACK PANEL

## BACK PANEL

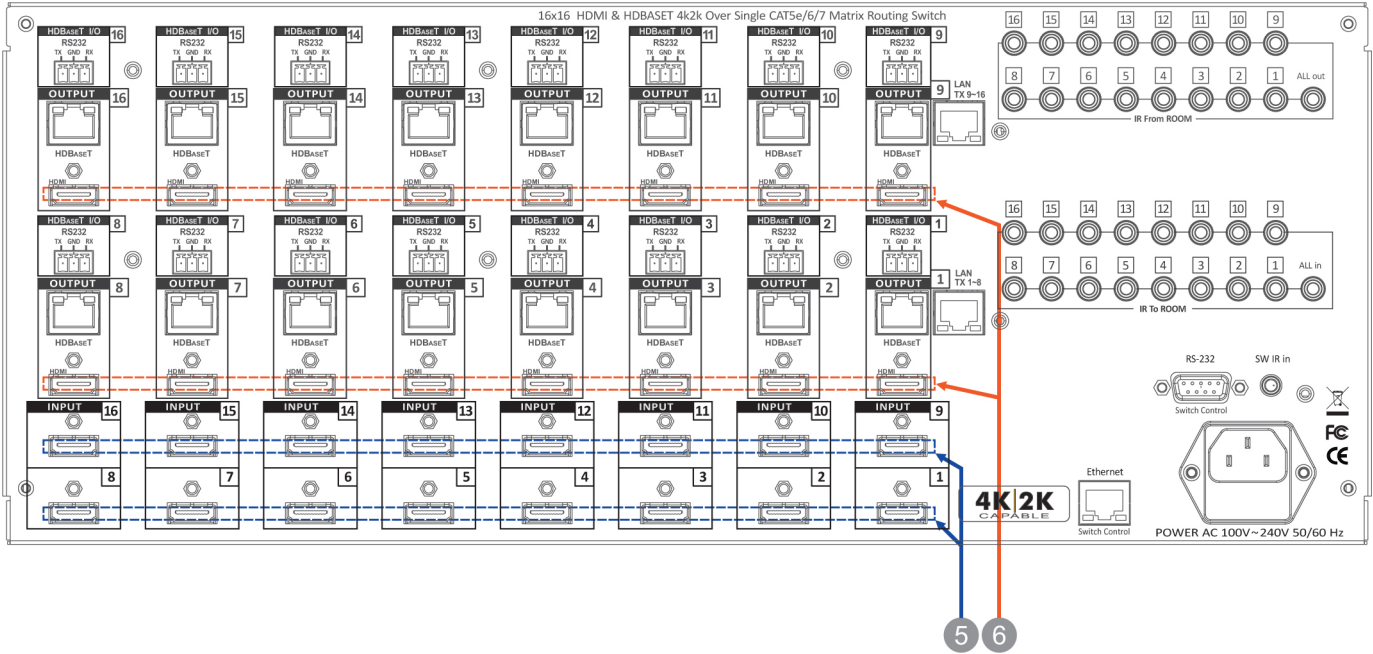

**5. INPUTS - 1~16 HDMI:** Connects a HDMI signal source to the Input. The HDMI port supports HDMI with embedded audio and DVI with AUX audio sources. If you remove the HDMI screw posts, you must use the provided HDMI Locking Post replacement screws to keep the internal HDMI jack secure. Removing the HDMI screws without installing the HDMI Locking Post replacement screws will void your warranty.



**HDMI CONNECTOR:** HDMI Type A SMD 19pin female socket connector  
**Note:** *With the proper adapters, the switcher can be used with DVI digital video signals, as it is HDCP compliant.*

**6. HDMI OUTPUTS 1 ~ 16:** Connects a HDMI signal source to the Output. The HDMI port supports HDMI with embedded audio and DVI with AUX audio. If you remove the HDMI screw posts, you must use the provided HDMI Locking Post replacement screws to keep the internal HDMI jack secure. Removing the HDMI screws without installing the HDMI Locking Post replacement screws will void your warranty.



**HDMI CONNECTOR:** HDMI Type A SMD 19pin female socket connector  
**Note:** *With the proper adapters, the switcher can be used with DVI digital video signals, as it is HDCP compliant.*

# BACK PANEL

## BACK PANEL

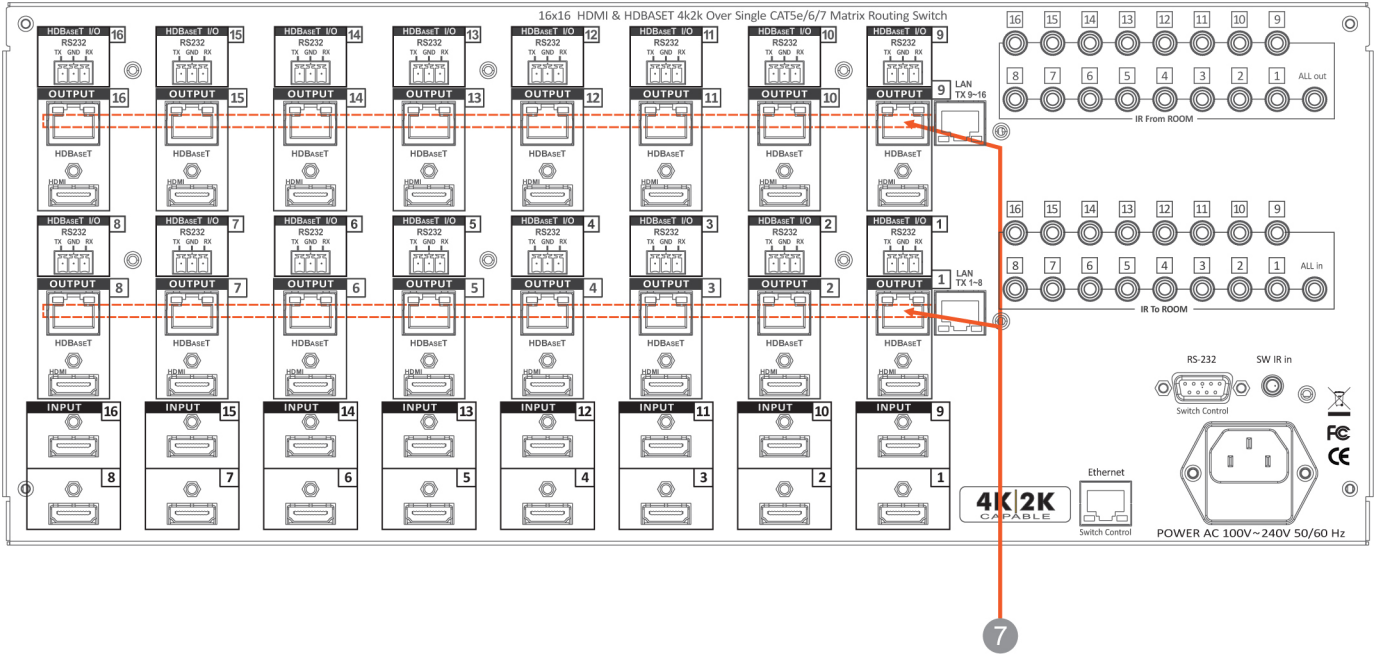

**7. OUTPUT - 1 ~ 16 HDBASET™ (TRANSMITTER):** Sends (16) HDMI and control signals via (16) HDBaseT™ Transmitters to link (16) external HDBaseT™ Receivers.

Switcher uses (16) HDBaseT™ Transmitter Outputs #1 ~ #16 with PoE (optional) RJ-45 via CAT6/6a/7 category cable. Controls IR input/output signals and RS-232 between the switcher and the HDBaseT™ Receiver.

**HDBASET™ TRANSMITTER CONNECTOR:** (16) RJ-45 jack 8P8C female socket

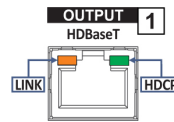

**Link LED:**  
 Solid = valid link  
 Flash = attempting to link  
 Off = no link established.

SB-5669CKP (with PoH)  
 16x16 HDMI-HDBaseT Matrix Switcher

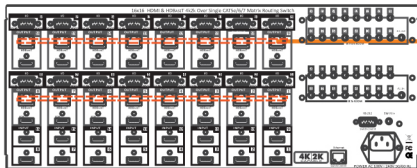

HDBaseT Transmitter with PoH

SB-6335R5  
 HDBaseT Receiver(with PoH)



CATx cable (100M) →

→

# BACK PANEL

## BACK PANEL

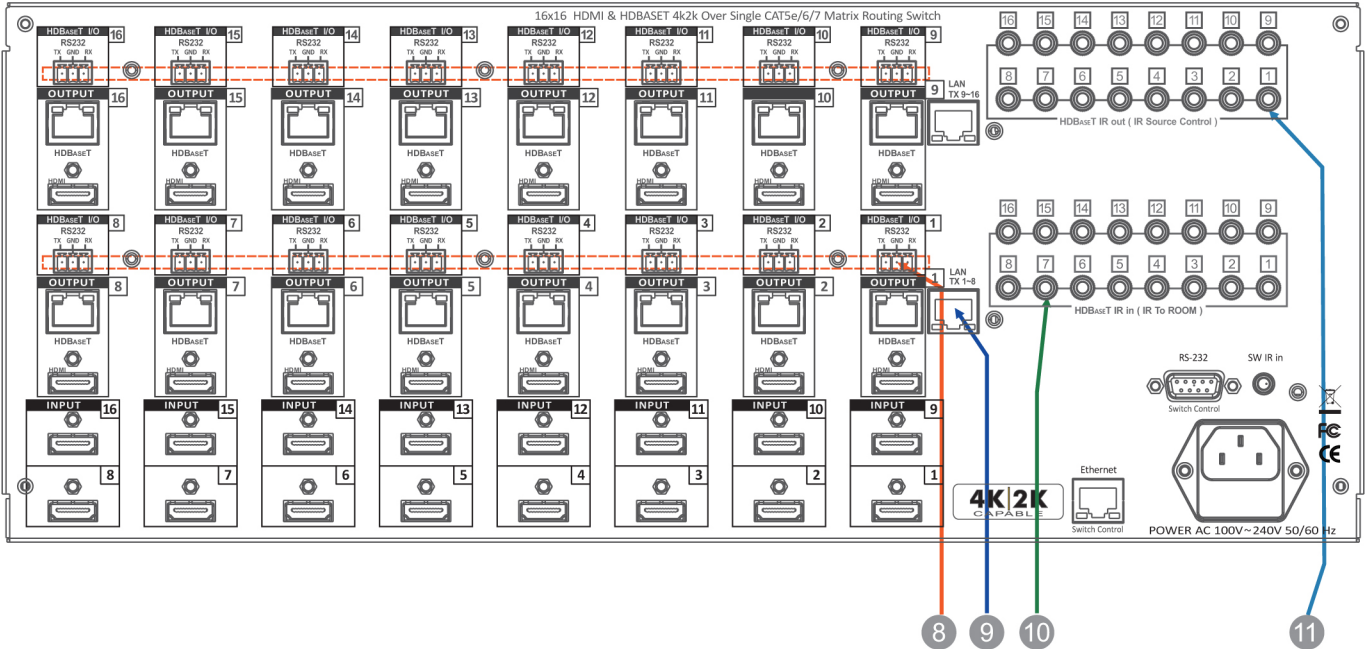

**8. HDBASET™ RS-232: 1~16 CONNECTION:** (16) RS-232 control ports allow for interfacing to a PC. Controls I/O via the switchers HDBaseT™ Transmitters to (16) rooms each via the D-Bub 9pin female socket for serial RS-232 control.



**REMOTE PORT:** DB-9pin female connector

**9. HDBASET™ LAN CONNECTION:** All Tx LAN: Provides Ethernet (LAN) connection from the switcher to All HDBaseT™ Transmitters (ie. SB-6335T5).



**ALL HDBASET™ TX LAN PORT CONNECTOR:** HDBaseT™ Phone-Jack 8P8C, RJ-45 female socket  
**LAN CONTROLS:** Note: From the switcher to the HDBaseT™ Transmitter.

**10. HDBASET™ IR INPUT: 1~16 REMOTE IR SIGNAL TO ROOM:** Sends (16) IR signals to (16) rooms via the switchers HDBaseT™ Transmitters. When you plug the switchers HDBaseT™ IR Transmitters into the external port, the room IR HDBaseT™ receiver remains active.



**IR EXTENDER JACK:** Female jack - inner OD Ø 3.5mm

**11. HDBASET™ IR OUTPUT: 1~16 REMOTE IR SIGNAL FROM ROOM:** Receives (16) IR signals from (16) rooms each via the switchers HDBaseT™ Transmitters. When you plug the switchers HDBaseT™ IR Transmitters into the external port, the room IR HDBaseT™ receiver remains active.



**IR EXTENDER JACK:** Female jack - inner OD Ø 3.5mm



# HDBASET™ I/O TRANSMISSION & CABLE EXTENSION LENGTHS

## HDBASET™ I/O TRANSMISSION

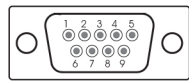
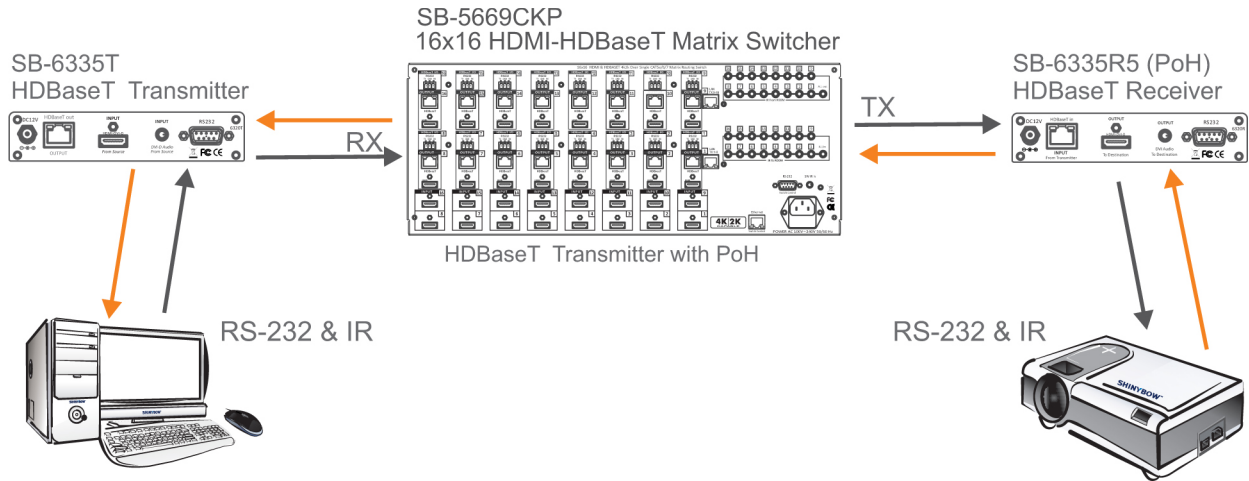

- 2 (RX)
- 3 (TX)
- 5 (GND)

RS-232 Cable Pins out  
PC 232 PINS  
DB-9P, MALE plug

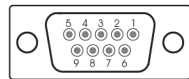

- (TX) 2 ●
- (RX) 3 ●
- (GND) 5 ●

HDBaseT Transmitter SB-6335T  
RS-232 PINS OUT  
DB-9P, FEMALE socket

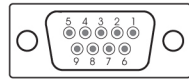

- (TX) 2 ●
- (RX) 3 ●
- (GND) 5 ●

HDBaseT Receiver SB-6335R  
RS-232 PINS OUT  
DB-9P, FEMALE socket

Category Cable Lengths via Switcher and HDBaseT™ Receiver

Cable Type Resolution	Pixel clock rate (MHZ)	CAT5e (70M)	CAT6 (100M)	CAT6 (100M)
1024x768@60Hz	65.00 MHZ	Yes	Yes	Yes
1280x720p@60Hz	73.84 MHZ	Yes	Yes	Yes
1920x1080i@60Hz	74.25 MHZ	NA	NA	NA
1280x1024@60Hz	108.00 MHZ	Yes	Yes	Yes
1920x1080p@60Hz	148.50 MHZ	Yes	Yes	Yes
1920x1200@60Hz	152.90 MHZ	Yes	Yes	Yes
1600x1200@60Hz	162.00 MHZ	Yes	Yes	Yes
Blue-Ray DVD player 1080p	174.00 MHZ	Yes	NA	Yes

# REMOTE CONTROL

## Before making any connections observe the following:

- Ensure the main voltage supply matches the label on the supplied plug-pack (+/-10%).
- Ensure that the power switch is OFF.
- Ensure that all system grounds (earth) are connected to a common point.
- Avoid powering equipment within a system from multiple power sources that may be separated by large distances.
- Connect all audio video sources and destination equipment.
- Power up all source and destination audio-visual sources.
- For each destination output select the appropriate input source by using the front panel input select buttons. The supplied IR remote control. Or through the RS-232 serial communications port.
- Upon powering up the switcher, it will return to its last used setting before being powered down.

## REMOTE CONTROL

### 1. & 2. SWITCH POWER ON or OFF:

Power ON and OFF

### 3. DESTINATION: 1 THRU 16 OUTPUT SELECTION:

Destination buttons to select the output display channel

### 4. SOURCE : 1 THRU 16 INPUT SOURCE SELECTION:

Inputs 1~16 source selection buttons

### 5. FUNCTION KEY: Function selection buttons

ALL	OFF	EDID	RECALL
ENTER	MEMORY	LOCK	

IR REMOTE : SW-5669CKP

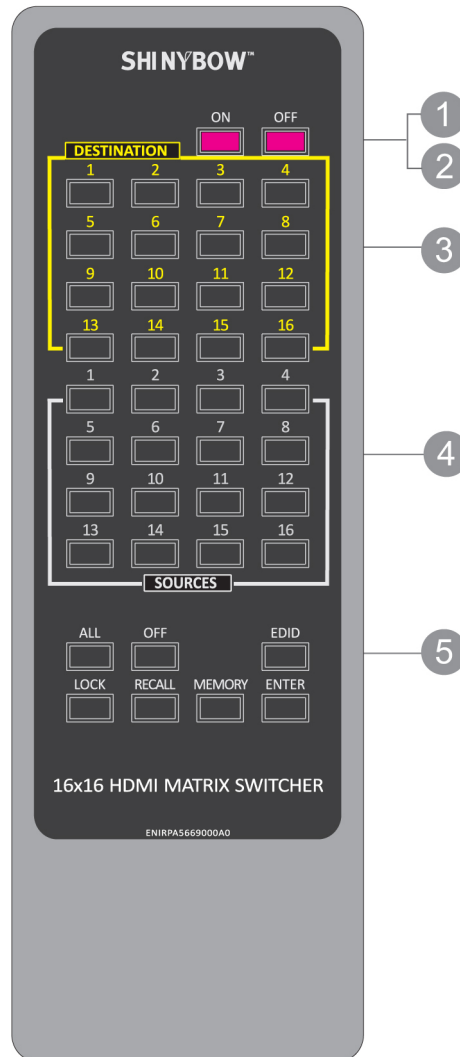

# REMOTE PROTOCOL COMMANDS

## IR REMOTE CUSTOM AND DATA CODES (NEC Standard)

---

### HOW TO SETUP IR CODES :

### CUSTOM CODE : 5BA4

POWER ON:	5BA4	A15E	ALL:	5BA4	B04F	RECALL:	5BA4	B24D
POWER OFF:	5BA4	A25D	OFF:	5BA4	B14E	MEMORY:	5BA4	B44B
EDID:	5BA4	B748	LOCK:	5BA4	B54A	ENTER:	5BA4	B34C

### HOW TO GIVE IR COMMANDS:

#### **PRESS DESTINATION - # then PRESS SOURCE - #**

DESTINATION #1 :	5BA4	10EF	SOURCE #1 :	5BA4	20DF
DESTINATION #2 :	5BA4	11EE	SOURCE #2 :	5BA4	21DE
DESTINATION #3 :	5BA4	12ED	SOURCE #3 :	5BA4	22DD
DESTINATION #4 :	5BA4	13EC	SOURCE #4 :	5BA4	23DC
DESTINATION #5 :	5BA4	14EB	SOURCE #5 :	5BA4	24DB
DESTINATION #6 :	5BA4	15EA	SOURCE #6 :	5BA4	25DA
DESTINATION #7 :	5BA4	16E9	SOURCE #7 :	5BA4	26D9
DESTINATION #8 :	5BA4	17E8	SOURCE #8 :	5BA4	27D8
DESTINATION #9 :	5BA4	18E7	SOURCE #9 :	5BA4	28D7
DESTINATION #10 :	5BA4	19E6	SOURCE #10 :	5BA4	29D6
DESTINATION #11 :	5BA4	1AE5	SOURCE #11 :	5BA4	2AD5
DESTINATION #12 :	5BA4	1BE4	SOURCE #12 :	5BA4	2BD4
DESTINATION #13 :	5BA4	1CE3	SOURCE #13 :	5BA4	2CD3
DESTINATION #14 :	5BA4	1DE2	SOURCE #14 :	5BA4	2DD2
DESTINATION #15 :	5BA4	1EE1	SOURCE #15 :	5BA4	2ED1
DESTINATION #16 :	5BA4	1FE0	SOURCE #16 :	5BA4	2FD0

#### *For Example:*

#### **Let Destination # 1 show the signal from Source #1~4**

The IR Data Code list :	5BA4	10EF	5BA4	20DF
Destination # 1 , Source #1	5BA4	10EF	5BA4	21DE
Destination # 1 , Source #2	5BA4	10EF	5BA4	22DD
Destination # 1 , Source #3	5BA4	10EF	5BA4	23DC
Destination # 1 , Source #4	5BA4	14EB	5BA4	24DB







# REMOTE CONTROL

## ROOM IR REMOTE CONTROL #01 ~ #09 CUSTOM CODE AND DATA CODES

### IR CUSTOM AND DATA CODES (NEC Standard)

PRESS Number To Select SOURCE

**CUSTOM CODE: 42BD**

16x16 HDMI-HDBT MX SW  
SW-5669CKP-IR01

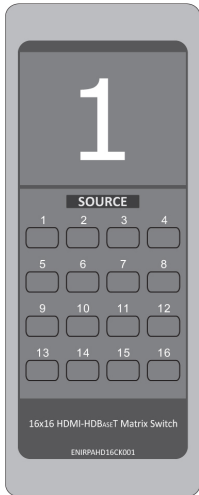

#### IR-01 DATA CODE:

SOURCE #1 : 42BD 00FF  
SOURCE #2 : 42BD 01FE  
SOURCE #3 : 42BD 02FD  
SOURCE #4 : 42BD 03FC  
SOURCE #5 : 42BD 04FB  
SOURCE #6 : 42BD 05FA  
SOURCE #7 : 42BD 06F9  
SOURCE #8 : 42BD 07F8  
SOURCE #9 : 42BD 08F7  
SOURCE #10 : 42BD 09F6  
SOURCE #11 : 42BD 0AF5  
SOURCE #12 : 42BD 0BF4  
SOURCE #13 : 42BD 0CF3  
SOURCE #14 : 42BD 0DF2  
SOURCE #15 : 42BD 0EF1  
SOURCE #16 : 42BD 0FF0

16x16 HDMI-HDBT MX SW  
SW-5669CKP-IR02

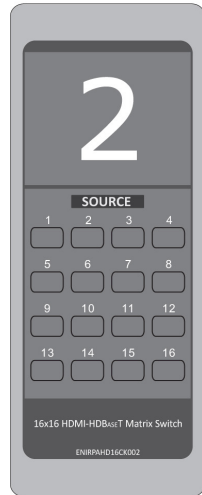

#### IR-02 DATA CODE:

SOURCE #1 : 42BD 10EF  
SOURCE #2 : 42BD 11EE  
SOURCE #3 : 42BD 12ED  
SOURCE #4 : 42BD 13EC  
SOURCE #5 : 42BD 14EB  
SOURCE #6 : 42BD 15EA  
SOURCE #7 : 42BD 16E9  
SOURCE #8 : 42BD 17E8  
SOURCE #9 : 42BD 18E7  
SOURCE #10 : 42BD 19E6  
SOURCE #11 : 42BD 1AE5  
SOURCE #12 : 42BD 1BE4  
SOURCE #13 : 42BD 1CE3  
SOURCE #14 : 42BD 1DE2  
SOURCE #15 : 42BD 1EE1  
SOURCE #16 : 42BD 1FE0

16x16 HDMI-HDBT MX SW  
SW-5669CKP-IR03

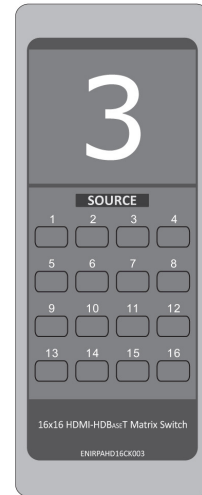

#### IR-03 DATA CODE:

SOURCE #1 : 42BD 20DF  
SOURCE #2 : 42BD 21DE  
SOURCE #3 : 42BD 22DD  
SOURCE #4 : 42BD 23DC  
SOURCE #5 : 42BD 24DB  
SOURCE #6 : 42BD 25DA  
SOURCE #7 : 42BD 26D9  
SOURCE #8 : 42BD 27D8  
SOURCE #9 : 42BD 28D7  
SOURCE #10 : 42BD 29D6  
SOURCE #11 : 42BD 2AD5  
SOURCE #12 : 42BD 2BD4  
SOURCE #13 : 42BD 2CD3  
SOURCE #14 : 42BD 2DD2  
SOURCE #15 : 42BD 2ED1  
SOURCE #16 : 42BD 2FD0

16x16 HDMI-HDBT MX SW  
SW-5669CKP-IR04



#### IR-04 DATA CODE:

SOURCE #1 : 42BD 30CF  
SOURCE #2 : 42BD 31CE  
SOURCE #3 : 42BD 32CD  
SOURCE #4 : 42BD 33CC  
SOURCE #5 : 42BD 34CB  
SOURCE #6 : 42BD 35CA  
SOURCE #7 : 42BD 36C9  
SOURCE #8 : 42BD 37C8  
SOURCE #9 : 42BD 38C7  
SOURCE #10 : 42BD 39C6  
SOURCE #11 : 42BD 3AC5  
SOURCE #12 : 42BD 3BC4  
SOURCE #13 : 42BD 3CC3  
SOURCE #14 : 42BD 3DC2  
SOURCE #15 : 42BD 3EC1  
SOURCE #16 : 42BD 3FC0

16x16 HDMI-HDBT MX SW  
SW-5669CKP-IR05

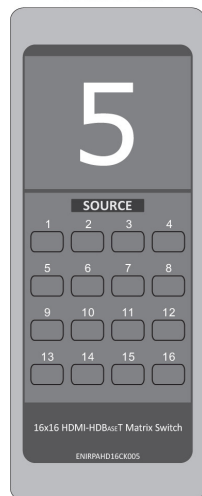

#### IR-05 DATA CODE:

SOURCE #1 : 42BD 40BF  
SOURCE #2 : 42BD 41BE  
SOURCE #3 : 42BD 42BD  
SOURCE #4 : 42BD 43BC  
SOURCE #5 : 42BD 44BB  
SOURCE #6 : 42BD 45BA  
SOURCE #7 : 42BD 46B9  
SOURCE #8 : 42BD 47B8  
SOURCE #9 : 42BD 48B7  
SOURCE #10 : 42BD 49B6  
SOURCE #11 : 42BD 4AB5  
SOURCE #12 : 42BD 4BB4  
SOURCE #13 : 42BD 4CB3  
SOURCE #14 : 42BD 4DB2  
SOURCE #15 : 42BD 4EB1  
SOURCE #16 : 42BD 4FB0

16x16 HDMI-HDBT MX SW  
SW-5669CKP-IR06



#### IR-06 DATA CODE:

SOURCE #1 : 42BD 50AF  
SOURCE #2 : 42BD 51AE  
SOURCE #3 : 42BD 52AD  
SOURCE #4 : 42BD 53AC  
SOURCE #5 : 42BD 54AB  
SOURCE #6 : 42BD 55AA  
SOURCE #7 : 42BD 56A9  
SOURCE #8 : 42BD 57A8  
SOURCE #9 : 42BD 58A7  
SOURCE #10 : 42BD 59A6  
SOURCE #11 : 42BD 5AA5  
SOURCE #12 : 42BD 5BA4  
SOURCE #13 : 42BD 5CA3  
SOURCE #14 : 42BD 5DA2  
SOURCE #15 : 42BD 5EA1  
SOURCE #16 : 42BD 5FA0

16x16 HDMI-HDBT MX SW  
SW-5669CKP-IR07



#### IR-07 DATA CODE:

SOURCE #1 : 42BD 609F  
SOURCE #2 : 42BD 619E  
SOURCE #3 : 42BD 629D  
SOURCE #4 : 42BD 639C  
SOURCE #5 : 42BD 649B  
SOURCE #6 : 42BD 659A  
SOURCE #7 : 42BD 6699  
SOURCE #8 : 42BD 6798  
SOURCE #9 : 42BD 6897  
SOURCE #10 : 42BD 6996  
SOURCE #11 : 42BD 6A95  
SOURCE #12 : 42BD 6B94  
SOURCE #13 : 42BD 6C93  
SOURCE #14 : 42BD 6D92  
SOURCE #15 : 42BD 6E91  
SOURCE #16 : 42BD 6F90

16x16 HDMI-HDBT MX SW  
SW-5669CKP-IR08



#### IR-08 DATA CODE:

SOURCE #1 : 42BD 708F  
SOURCE #2 : 42BD 718E  
SOURCE #3 : 42BD 728D  
SOURCE #4 : 42BD 738C  
SOURCE #5 : 42BD 748B  
SOURCE #6 : 42BD 758A  
SOURCE #7 : 42BD 7689  
SOURCE #8 : 42BD 7788  
SOURCE #9 : 42BD 7887  
SOURCE #10 : 42BD 7986  
SOURCE #11 : 42BD 7A85  
SOURCE #12 : 42BD 7B84  
SOURCE #13 : 42BD 7C83  
SOURCE #14 : 42BD 7D82  
SOURCE #15 : 42BD 7E81  
SOURCE #16 : 42BD 7F80

16x16 HDMI-HDBT MX SW  
SW-5669CKP-IR09



#### IR-09 DATA CODE:

SOURCE #1 : 42BD 807F  
SOURCE #2 : 42BD 817E  
SOURCE #3 : 42BD 827D  
SOURCE #4 : 42BD 837C  
SOURCE #5 : 42BD 847B  
SOURCE #6 : 42BD 857A  
SOURCE #7 : 42BD 8679  
SOURCE #8 : 42BD 8778  
SOURCE #9 : 42BD 8877  
SOURCE #10 : 42BD 8976  
SOURCE #11 : 42BD 8A75  
SOURCE #12 : 42BD 8B74  
SOURCE #13 : 42BD 8C73  
SOURCE #14 : 42BD 8D72  
SOURCE #15 : 42BD 8E71  
SOURCE #16 : 42BD 8F70

# REMOTE CONTROL

## ROOM IR REMOTE CONTROL #10 ~ #16 CUSTOM CODE AND DATA CODES

### IR CUSTOM AND DATA CODES (NEC Standard)

PRESS Number To Select SOURCE

#### CUSTOM CODE: 42BD

16x16 HDMI-HDBT MX SW  
SW-5669CKP-IR10

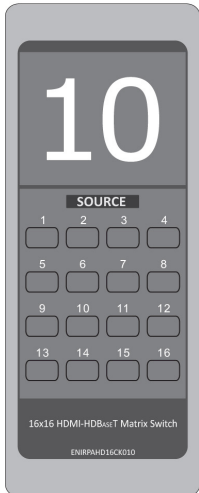

#### IR-10 DATA CODE:

SOURCE #1 : 42BD 906F  
SOURCE #2 : 42BD 916E  
SOURCE #3 : 42BD 926D  
SOURCE #4 : 42BD 936C  
SOURCE #5 : 42BD 946B  
SOURCE #6 : 42BD 956A  
SOURCE #7 : 42BD 9669  
SOURCE #8 : 42BD 9768  
SOURCE #9 : 42BD 9867  
SOURCE #10 : 42BD 9966  
SOURCE #11 : 42BD 9A65  
SOURCE #12 : 42BD 9B64  
SOURCE #13 : 42BD 9C63  
SOURCE #14 : 42BD 9D62  
SOURCE #15 : 42BD 9E61  
SOURCE #16 : 42BD 9F60

16x16 HDMI-HDBT MX SW  
SW-5669CKP-IR11

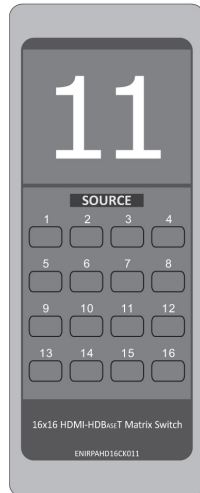

#### IR-11 DATA CODE:

SOURCE #1 : 42BD A05F  
SOURCE #2 : 42BD A15E  
SOURCE #3 : 42BD A25D  
SOURCE #4 : 42BD A35C  
SOURCE #5 : 42BD A45B  
SOURCE #6 : 42BD A55A  
SOURCE #7 : 42BD A659  
SOURCE #8 : 42BD A758  
SOURCE #9 : 42BD A857  
SOURCE #10 : 42BD A956  
SOURCE #11 : 42BD AA55  
SOURCE #12 : 42BD AB54  
SOURCE #13 : 42BD AC53  
SOURCE #14 : 42BD AD52  
SOURCE #15 : 42BD AE51  
SOURCE #16 : 42BD AF50

16x16 HDMI-HDBT MX SW  
SW-5669CKP-IR12

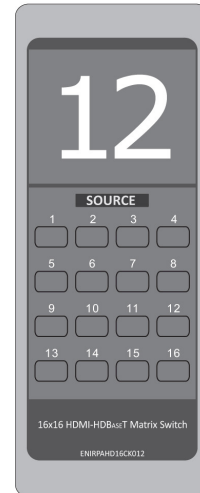

#### IR-12 DATA CODE:

SOURCE #1 : 42BD B04F  
SOURCE #2 : 42BD B14E  
SOURCE #3 : 42BD B24D  
SOURCE #4 : 42BD B34C  
SOURCE #5 : 42BD B44B  
SOURCE #6 : 42BD B54A  
SOURCE #7 : 42BD B649  
SOURCE #8 : 42BD B748  
SOURCE #9 : 42BD B847  
SOURCE #10 : 42BD B946  
SOURCE #11 : 42BD BA45  
SOURCE #12 : 42BD BB44  
SOURCE #13 : 42BD BC43  
SOURCE #14 : 42BD BD42  
SOURCE #15 : 42BD BE41  
SOURCE #16 : 42BD BF40

16x16 HDMI-HDBT MX SW  
SW-5669CKP-IR13



#### IR-13 DATA CODE:

SOURCE #1 : 42BD C03F  
SOURCE #2 : 42BD C13E  
SOURCE #3 : 42BD C23D  
SOURCE #4 : 42BD C33C  
SOURCE #5 : 42BD C43B  
SOURCE #6 : 42BD C53A  
SOURCE #7 : 42BD C639  
SOURCE #8 : 42BD C738  
SOURCE #9 : 42BD C837  
SOURCE #10 : 42BD C936  
SOURCE #11 : 42BD CA35  
SOURCE #12 : 42BD CB34  
SOURCE #13 : 42BD CC33  
SOURCE #14 : 42BD CD32  
SOURCE #15 : 42BD CE31  
SOURCE #16 : 42BD CF30

16x16 HDMI-HDBT MX SW  
SW-5669CKP-IR14

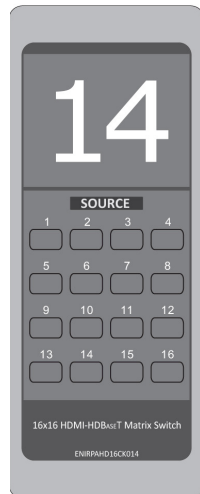

#### IR-14 DATA CODE:

SOURCE #1 : 42BD D02F  
SOURCE #2 : 42BD D12E  
SOURCE #3 : 42BD D22D  
SOURCE #4 : 42BD D32C  
SOURCE #5 : 42BD D42B  
SOURCE #6 : 42BD D52A  
SOURCE #7 : 42BD D629  
SOURCE #8 : 42BD D728  
SOURCE #9 : 42BD D827  
SOURCE #10 : 42BD D926  
SOURCE #11 : 42BD DA25  
SOURCE #12 : 42BD DB24  
SOURCE #13 : 42BD DC23  
SOURCE #14 : 42BD DD22  
SOURCE #15 : 42BD DE21  
SOURCE #16 : 42BD DF20

16x16 HDMI-HDBT MX SW  
SW-5669CKP-IR15

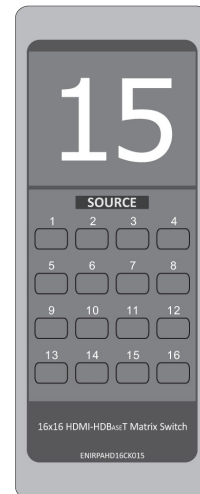

#### IR-15 DATA CODE:

SOURCE #1 : 42BD E01F  
SOURCE #2 : 42BD E11E  
SOURCE #3 : 42BD E21D  
SOURCE #4 : 42BD E31C  
SOURCE #5 : 42BD E41B  
SOURCE #6 : 42BD E51A  
SOURCE #7 : 42BD E619  
SOURCE #8 : 42BD E718  
SOURCE #9 : 42BD E817  
SOURCE #10 : 42BD E916  
SOURCE #11 : 42BD EA15  
SOURCE #12 : 42BD EB14  
SOURCE #13 : 42BD EC13  
SOURCE #14 : 42BD ED12  
SOURCE #15 : 42BD EE11  
SOURCE #16 : 42BD EF10

16x16 HDMI-HDBT MX SW  
SW-5669CKP-IR16

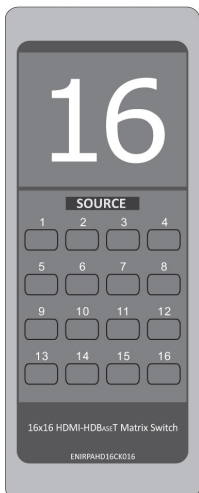

#### IR-16 DATA CODE:

SOURCE #1 : 42BD F00F  
SOURCE #2 : 42BD F10E  
SOURCE #3 : 42BD F20D  
SOURCE #4 : 42BD F30C  
SOURCE #5 : 42BD F40B  
SOURCE #6 : 42BD F50A  
SOURCE #7 : 42BD F609  
SOURCE #8 : 42BD F708  
SOURCE #9 : 42BD F807  
SOURCE #10 : 42BD F906  
SOURCE #11 : 42BD FA05  
SOURCE #12 : 42BD FB04  
SOURCE #13 : 42BD FC03  
SOURCE #14 : 42BD FD02  
SOURCE #15 : 42BD FE01  
SOURCE #16 : 42BD FF00

# RS-232 & ETHERNET SERIAL INTERFACE

## ETHERNET / RS-232 SERIAL INTERFACE CONNECTS a PC or CONTROL SYSTEM VERSION V2.0

For a complete list of commands, please reference external document extended Ethernet Protocol Instruction Manual.

Example of the commanded string to select Inputs:

FUNCTION	COMMAND	VARIABLES
Select source	Source xxx;	xxx = Input Channel (001=Source1, 002=Source2, etc.)
COMMAND EXAMPLE	RESPONSE	DESCRIPTION
Source 001;	Source 001#ok;	Select source number 1

### Ethernet

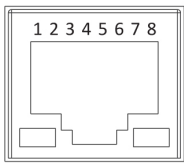

SPD LINK

**Note:** Control the switcher

SPD: Speed

LINK: Ethernet link

RJ-45 Female 8P-8C Connector

### ETHERNET SERIAL INTERFACE

Pin	Ethernet	Reference
1	TXOP	TX +
2	TXON	TX -
3	RXIP	RX +
4	NC	
5	NC	
6	RXIN	RX -
7	NC	
8	GND	

## ETHERNET TCP/IP PROTOCOL COMMANDS ( Ethernet / RS-232 Control driver V2.0 )

\*\*\* The Ethernet port and RS-232 port cannot be used simultaneously. Any connection to the Ethernet Control port will disable serial commands sent to the RS-232 port.\*\*\*

### RS-232 Configuration

RS-232 cable is a straight thru cable and not null-modem

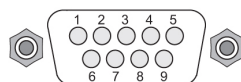
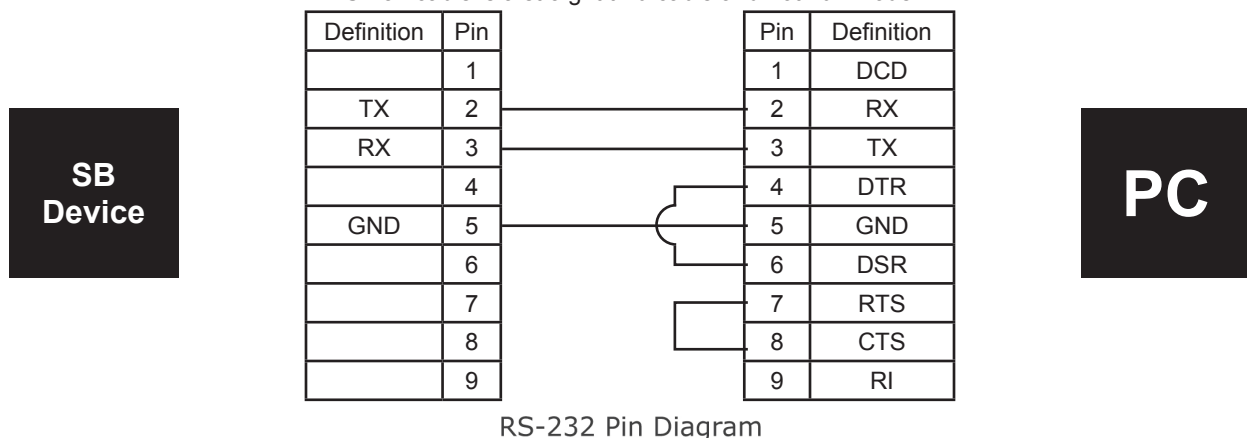



## RS-232 SERIAL INTERFACE PROTOCOL COMMANDS ( Ethernet / RS-232 Control driver V2.0 )

The SB-5669CKP switcher can be controlled via the RS-232 serial control port to allow for interfacing to a PC, or similar third party control system. The serial communication parameters are 9600 baud, 8 bit, No Parity and 1 stop bit - this is often referred to as 9600 8N1. When the unit recognizes a complete command it will perform the requested action - there is no delimiter character required.



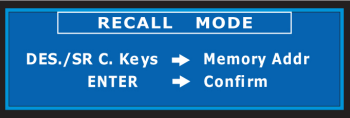
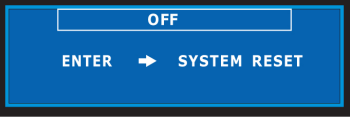

# EDID FUNCTION - SYSTEM RESET/FACTORY RESET

## SYSTEM RESET

SYSTEM RESET	RETURN SWITCH TO FACTORY DEFAULTS
<p>Press <b>RECALL &gt; OFF &gt; ENTER</b></p>   	<p><b>RESET to Factory Default</b></p> <ol style="list-style-type: none"> <li>1. Press <b>RECALL</b> button: The LCM will show the current stored presets status.</li> <li>2. Press <b>OFF</b> button: The LCM will show “<b>SYSTEM RESET</b>”</li> <li>3. Press <b>ENTER</b> button: To confirm entries. The switch will reset all customizable values back to factory defaults. You must <b>POWER CYCLE</b> the switch for the new values to take effect.</li> </ol>
<p><b>NOTE:</b> Factory Reset Defaults to:</p> <ol style="list-style-type: none"> <li>1. Source Destination will be set to 1-1, 2-2, 3-3, etc.</li> <li>2. Switch matrices stored in memory will be cleared.</li> <li>3. Lock function will return to Un-Locked.</li> <li>4. AUX function will disable and return to UN-AUX (On Select Models).</li> <li>5. ARC function will disable and return to SPDIF as the Output (On Select Models).</li> <li>6. EDID will return to FSS® (1080p-2ch Mode).</li> <li>7. Ethernet port will return to DHCP=ENABLED.</li> </ol>	

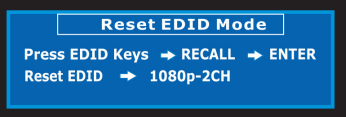
## RESET EDID

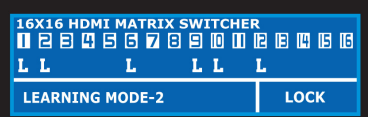
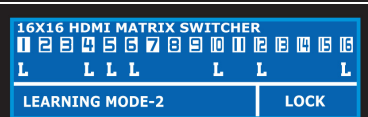
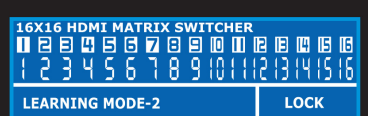
EDID RESET	PROCEDURE
<p><b>From the Front Panel:</b> Press <b>EDID &gt; RECALL &gt; OFF &gt; ENTER</b></p> 	<p><b>RESET EDID</b></p> <p>Press <b>EDID</b>.</p> <p>Press <b>RECALL</b>.</p> <p>Press <b>OFF</b>. The display should show Reset EDID.</p> <p>Press <b>ENTER</b>.</p>
<p><b>LEARNING MODE 2</b></p> <p>Press <b>EDID &gt; OFF &gt; DESTINATIONS &gt; ENTER</b> The EDID for HDMI has been passed from the Destination port to the Source port.</p>    	<p><b>SETTING EDID TO LEARNING MODE 2</b></p> <ol style="list-style-type: none"> <li>1. Press <b>EDID</b> button: The LCM will show the current EDID status.</li> <li>2. Press <b>OFF</b> button: Does the OFF button stay illuminated? <ul style="list-style-type: none"> <li><b>*If Yes:</b> Press ALL the Destination buttons individually so they illuminate blue. The switcher will <b>LEARN</b> the destination HDMI EDID and pass to the selected source. The switcher will Enable or Disable HDMI EDID for the selected source.</li> </ul> </li> <li>3. Press <b>ENTER</b> to confirm changes. The LCM will return to the default screen showing selected matrix routing status. This puts you in Learning Mode 2. <ul style="list-style-type: none"> <li><b>*If No:</b> You might need a f/w update.</li> </ul> </li> </ol>

# EDID FUNCTION

## EDID FUNCTION FOR HDMI MATRIX SWITCHER

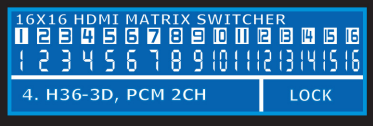
EDID STATUS	To View The Current EDID Status
<b>Step 1.</b> Press <b>EDID</b> button	The button will flash blue and the display will show the current Embedded EDID Status.
<b>Step 2.</b> Press <b>EDID</b> button	To exit.
EDID SETUP	To Change The EDID Setup
<b>Step 1.</b> Press the <b>EDID</b> button	The display will show the currently selected EDID mode.
<b>Step 2.</b> Press <b>SOURCE #1 OR #2</b> button row	The button will flash blue and the display will show the current <b>Embedded EDID</b> Status.
<b>Step 3.</b> Press the <b>ENTER</b> button	To set EDID mode. The switcher will return to operation mode.
Operation will abort if no keys are pressed within 5 seconds.	
EMBEDDED EDID MODES	Total 7 EDID Modes
<b>Embedded EDID Setup</b> Press <b>EDID &gt; SOURCE &gt; ENTER</b> SOURCE #1 or SOURCE #2 	To select Embedded EDID mode or LEARNING mode. Repeatedly pressing the <b>SOURCE 1</b> button will cycle up thru the options. Repeatedly pressing the <b>SOURCE 2</b> button will cycle down thru the options.  <b>Embedded EDID:</b> Mode 1 : FSS® Mode 2 : H24-3D Mode 3 : H24-3D-M Mode 4 : H36-3D Mode 5 : H36-3D-M Mode 6 : 4K2K (24/30Hz) Mode 7 : DVI-D 1920x1200-60Hz
HOW TO SETUP FSS® FUNCTION	Fast Speed Start®
<b>Step 1.</b> Press the <b>DESTINATION #1~16</b> button row Then Press the <b>SOURCE #1~16</b> button row	To setup and Install all devices.
<b>Step 2.</b> Press <b>EDID</b> button	Select a optimum status of Embedded EDID mode.
<b>Step 3.</b> Press <b>ENTER</b> button	To confirm entries.
<b>Step 4.</b> Press <b>EDID</b> button	To select the EDID FSS® mode.
<b>Step 5.</b> Press <b>ENTER</b> button	To confirm entries.

# EDID FUNCTION

## (7) EDID MODE: EDID MANAGEMENT FOR HDMI MATRIX SWITCH

<p><b>Mode 1. FSS® (Fast Speed Start®)</b></p> <div style="border: 2px solid black; padding: 5px; background-color: #0056b3; color: white; text-align: center;"> <p><b>EDID MODE SELECTION</b></p> <p>1. FAST SPEED START SRC. #1#2 → EDID Mode Selection</p> </div>	<p>Fast Speed Start® mode shortens the startup time of the switcher. Selecting this mode does not force the EDID setup to be cancelled. Users may first select one EDID mode from mode 2 to 7, and then select mode 1 for fast speed start®.</p>
<p><b>Mode 2. H24-3D (1080p-24 bits)</b></p> <div style="border: 2px solid black; padding: 5px; background-color: #0056b3; color: white; text-align: center;"> <p><b>EDID MODE SELECTION</b></p> <p>2. H24-3D, PCM 2CH SRC. #1#2 → EDID Mode Selection</p> </div>	<p>Audio Support: PCM 2CH</p>
<p><b>Mode 3. H24-3D-M (1080p-24 bits)</b></p> <div style="border: 2px solid black; padding: 5px; background-color: #0056b3; color: white; text-align: center;"> <p><b>EDID MODE SELECTION</b></p> <p>3. H24-3D, MULTI AUDIO SRC. #1#2 → EDID Mode Selection</p> </div>	<p>Audio Support: MAT(MLP) 7.1CH, PCM2CH, One Bit Audio 2CH, AC-3 5.1CH, DTS5.1CH, PCM7.1CH, Dolby Digital + 7.1CH, DTS-HD 7.1CH</p>
<p><b>Mode 4. H36-3D-M (1080p-36 bits)</b></p> <div style="border: 2px solid black; padding: 5px; background-color: #0056b3; color: white; text-align: center;"> <p><b>EDID MODE SELECTION</b></p> <p>4. H36-3D, PCM 2CH SRC. #1#2 → EDID Mode Selection</p> </div>	<p>Audio Support: PCM 2CH</p>
<p><b>Mode 5. H36-3D (1080p-36 bits)</b></p> <div style="border: 2px solid black; padding: 5px; background-color: #0056b3; color: white; text-align: center;"> <p><b>EDID MODE SELECTION</b></p> <p>5. H36-3D, MULTI AUDIO SRC. #1#2 → EDID Mode Selection</p> </div>	<p>Audio Support: MAT(MLP) 7.1CH, PCM2CH, One Bit Audio 2CH, AC-3 5.1CH, DTS5.1CH, PCM7.1CH, Dolby Digital + 7.1CH, DTS-HD 7.1CH</p>
<p><b>Mode 6. 4K2K (24/30Hz)</b></p> <div style="border: 2px solid black; padding: 5px; background-color: #0056b3; color: white; text-align: center;"> <p><b>EDID MODE SELECTION</b></p> <p>6. 4K2K-3D PCM 2CH SRC. #1#2 → EDID Mode Selection</p> </div>	<p>HDMI Support: 4K2K-3D, PCM 2CH (3840x2160-24/30Hz)</p> <p>Audio Support: PCM 2CH</p>
<p><b>Mode 7. 1920x1200-60Hz (DVI-D)</b></p> <div style="border: 2px solid black; padding: 5px; background-color: #0056b3; color: white; text-align: center;"> <p><b>EDID MODE SELECTION</b></p> <p>7. DVI. 1920x1200-60Hz SRC. #1#2 → EDID Mode Selection</p> </div>	<p>DVI Support: DVI-D 1920x1200 60Hz</p>

# EDID FUNCTION



## EDID FUNCTION LEARNING MODE

LEARNING EDID SINGLE TO SINGLE	Learning Destination #8 EDID To Source #5
<b>Step 1.</b> Press <b>EDID</b> button	The button will flash blue and the display will show the current <b>Embedded EDID</b> Status.
<b>Step 2.</b> Press the <b>DESTINATION #8</b> button row	Copy the Destination #8 Display EDID.
<b>Step 3.</b> Press the <b>SOURCE #5</b> button row	Learning the Destination #8 EDID To Source #5.
<b>Step 4.</b> Press <b>ENTER</b> button	To confirm entries.
LEARNING EDID SINGLE TO MULTIPLE	Learning Destination EDID Link To The Majority Sources
<b>Step 1.</b> Press <b>EDID</b> button	The button will flash blue and the display will show the current Embedded EDID Status.
<b>Step 2.</b> Press the <b>DESTINATION #1-16</b> button row	Copy any 1~16 Destinations EDID.
<b>Step 3.</b> Press the <b>SOURCE #1-16</b> button row	Learning the Destination EDID link to source #1-16.
<b>Step 4.</b> Press <b>ENTER</b> button	To confirm entries.
LEARNING EDID SINGLE TO ALL	Learning Destination EDID Link To All Sources
<b>Step 1.</b> Press <b>EDID</b> button	The button will flash blue and the display will show the current Embedded EDID Status.
<b>Step 2.</b> Press destination button <b>1 THRU 2</b>	Learning anyone 1~2 Destination EDID to all sources.
<b>Step 3.</b> Press <b>ALL</b> button	Learning selected destination EDID to all sources.
<b>Step 4.</b> Press <b>ENTER</b> button	To confirm entries.
SINGLE LEARNING #1 DEFINITION	Single Learning EDID From Destination To Source
<p>1. The switcher will <b>LEARN</b> the destination EDID and pass to the selected source.</p> <p>2. To set up learning between a single destination and single source: Press <b>EDID</b> button &gt; Press <b>DESTINATION 1 THRU 4</b> &gt; Press <b>SOURCE 1 THRU 4</b> &gt; Press <b>ENTER</b> to confirm. The switcher will learn the destination EDID for the source device.</p> <p>3. To set up learning between a single destination and multiple sources: Press <b>EDID</b> button &gt; Press <b>DESTINATION 1 THRU 4</b> &gt; Press the majority <b>SOURCES 1 THRU 4</b> &gt; Press <b>ENTER</b>. The switcher will learn the single destination EDID to many source devices.</p> <p>4. How to Learn single destinations with all sources. Press <b>EDID</b> button &gt; Press <b>ALL</b> button &gt; Press <b>ENTER</b> to confirm.</p>	

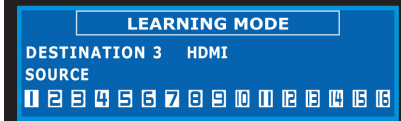

# EDID FUNCTION

## LEARNING EDID MODE-1 FUNCTION FOR HDMI MATRIX SWITCH

LEARNING HDMI/HDBaseT™ EDID	Learning HDMI or HDBaseT™ From Destination To Source
<p>Learning HDMI EDID Single HDMI-Destination to Multiple / All Sources</p>	
<p>Press <b>EDID &gt; DESTINATION &gt; SOURCE &gt; ENTER</b></p>	
	<p>Press <b>EDID &gt; DESTINATION</b> Button: The LCM will show LEARNING.</p> <p>The switcher will <b>LEARN</b> destination HDMI EDID and pass the selected source.</p> <p>Learning EDID setup for HDMI</p> <p>Key Sequence: <b>EDID &gt; DESTINATION (1) THRU (16) &gt; SOURCE (1) THRU (16) &gt; ENTER</b>. The EDID for HDMI has been learned.</p>
<p>Learning HDBaseT™ EDID Single HDBaseT™-Destination to Multiple / All Sources</p>	
<p>Press <b>EDID &gt; DESTINATION &gt; DESTINATION &gt; SOURCE &gt; ENTER</b></p>	
	<p>The Switcher will <b>LEARN</b> destination HDBaseT™ CATx EDID and pass the selected source.</p> <p>Learning EDID setup for HDBaseT™ CATx</p> <p>Key Sequence: <b>EDID &gt; DESTINATION (1) THRU (16) &gt; DESTINATION (1) THRU (16) &gt; SOURCE (1) THRU (16) &gt; ENTER</b></p> <p>Again, Press the same <b>DESTINATION #</b> to learn HDBaseT™ CATx EDID. The EDID for HDBaseT™ CATx has been learned</p>

## EDID FUNCTION: LEARNING EDID MODE-1 - SINGLE TO SINGLE

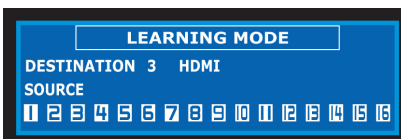
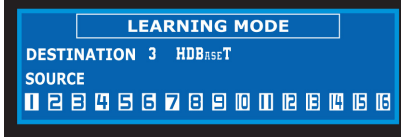
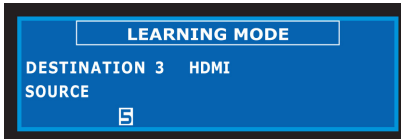
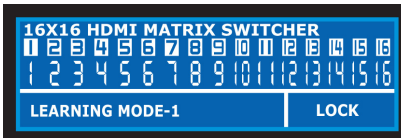
Learning Mode-1 Single Destination To Single Source	
<p>Key Sequence: <b>EDID &gt; DESTINATION 1 THRU 16 &gt; DESTINATION 1 THRU 16 &gt; SOURCE 1 THRU 16 &gt; ENTER</b></p>	
<p>The EDID for HDMI or HDBaseT™ has been learned from the Destination port to the Source port.</p>	
	<p>1. Press <b>EDID</b> button. The LCM will show the current EDID status.</p>
	<p>2. Press <b>DESTINATION (#1 ~ #16)</b>. The LCM will show LEARNING HDMI. The switcher will Learn destination (3) HDMI EDID.</p>
	<p>Press <b>DESTINATION</b> (3) button again. The LCM will show the LEARNING HDBaseT™. The switcher will Learn destination (3) HDBaseT™ EDID.</p>
	<p>3. Press <b>SOURCE (#1 ~ #16)</b>. The LCM will show the selected sources.  <b>Example:</b> Select Source (5). The switcher will learn destination (5) EDID HDMI or HDBaseT™ EDID and pass to the selected source.</p>
	<p>4. Press <b>ENTER</b> to confirm changes. The LCM will return to the default screen selected switch routing status.</p>

**NOTE:** The already learned EDID cannot be modified. You can only rebuild a new Learning EDID.

**For Example:** When the Source has “Learned” the EDID data from a destination, it will save that EDID information into EPROM and the EDID data cannot change. Please select new learning destination to sources or change to one of the embedded EDID modes when you want to remove the learning EDID memory from EPROM.

# EDID FUNCTION

## EDID FUNCTION: LEARNING EDID MODE-1-SINGLE TO MULTIPLE

### Learning Mode-1 Single Destination To Multiple Or All Sources

**Key Sequence: EDID > DESTINATION 1 THRU 16 > DESTINATION 1 THRU 16 > SOURCE 1 THRU 16 > ENTER**

The EDID for HDMI or HDBaseT™ has been learned from the Destination port to the Source port.

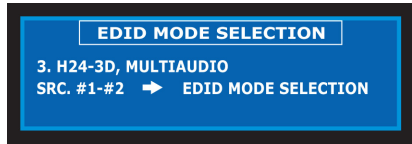
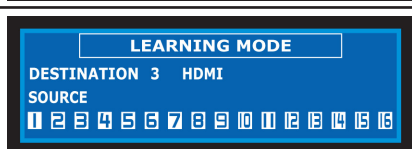
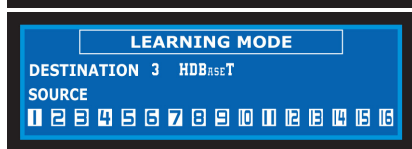
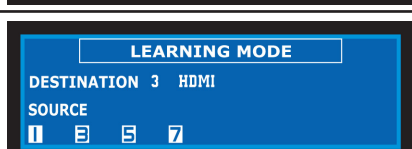
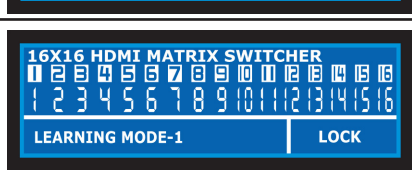
	1. Press <b>EDID</b> button. The LCM will show the current EDID status.
	2. Press <b>DESTINATION (#1 ~ #16)</b> . The LCM will show the LEARNING HDMI. The switcher will Learn destination (3) HDMI EDID.
	Press <b>DESTINATION</b> (3) button again. The LCM will show the LEARNING HDBaseT™. The switcher will Learn destination (3) HDBaseT™ EDID.
	3. Press <b>SOURCE (#1 ~ #16)</b> . The LCM will show the selected sources. <b>Example:</b> Select Source 1, 3, 5 & 7. The Switcher will learn the destination EDID HDMI or HDBaseT™ EDID and pass to the selected source.
	4. Press <b>ENTER</b> to confirm changes. The LCM will return to the default screen selected switch routing status.

**NOTE:** The already learned EDID cannot be modified. You can only rebuild a new Learning EDID.

**For Example:** When the Source has “Learned” the EDID data from a destination, it will save that EDID information into EPROM and the EDID data cannot change. Please select new learning destination to sources or change to one of the embedded EDID modes when you want to remove the learning EDID memory from EPROM.

# EDID FUNCTION

## EDID FUNCTION: LEARNING EDID MODE-2-MULTIPLE TO MULTIPLE

### Learning Mode-2 Multiple Destinations To ALL Sources

**Key Sequence: EDID > OFF > DESTINATION 1 THRU 16 > ENTER**

The EDID for HDMI or HDBaseT™ has been learned from the Destination port to the Source port.

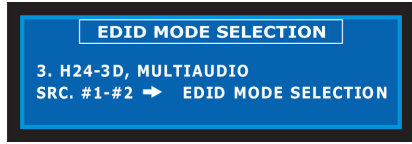
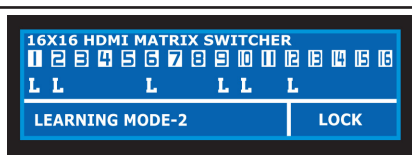
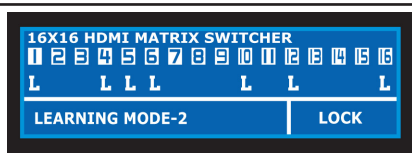
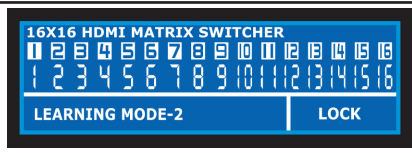
	<p>1. Press <b>EDID</b> button. The LCM will show the current EDID status.</p>
	<p>2. Press <b>OFF</b> button. The LCM will show the current EDID LEARN status.</p>
	<p>3. Press <b>DESTINATION 1 THRU 16</b>. The switcher will LEARN destination HDMI EDID and pass to the selected source. The switcher will Enable or Disable HDMI EDID for the selected source.</p>
	<p>4. Press <b>ENTER</b> to confirm changes. The LCM will return to the default screen selected switch routing status.</p>

**NOTE:** The already learned EDID cannot be modified. You can only rebuild a new Learning EDID.

**For Example:** When the Source has “Learned” the EDID data from a destination, it will save that EDID information into EPROM and the EDID data cannot change. Please select new learning destination to sources or change to one of the embedded EDID modes when you want to remove the learning EDID memory from EPROM.

## COMPARISON TABLE

	Function	Note
<b>Learning Mode</b>	Let the source device(s) learn the EDID from a single source and output video and audio accordingly.	When a source device has “learned” the EDID information of a destination device, the switcher will save that EDID into EPROM and the stored EDID cannot be altered. If you want to remove the EDID, set a new learning route for the source.
<b>FSS Mode (Mode 1)</b>	Shorten the startup time of the switcher.	After the desired EDID setup is complete, use FSS mode and the switcher will be faster at startup.
<b>Mode 2 ~ 7</b>	Let all source devices output the specified video and audio formats.	Consult the spec documentation of your devices and select the mode that best suits them.

# IR EXTENDER

## 1. SB-100 IR 300M Receiver

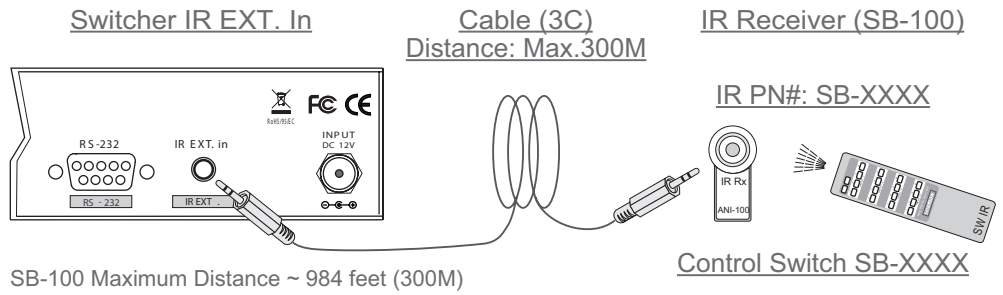

The SB-100 IR Receiver is required when using the port "ALL in" Jack.

## 2. SB-100C IR 2M Receiver

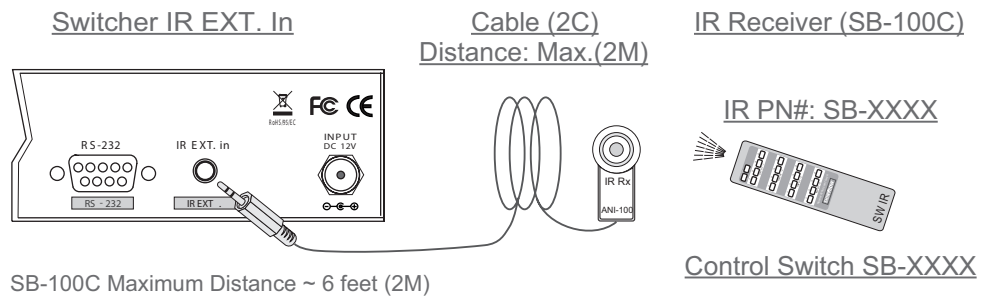

The SB-100C IR Receiver will not function on the port "ALL in" Jack.

\*\*\* When you plug the External IR extender into the switcher, the front panel IR receiver remains active. \*\*\*

Pin configuration for IR 984 feet (300M) Extender Receiver such as SB-100 compatible

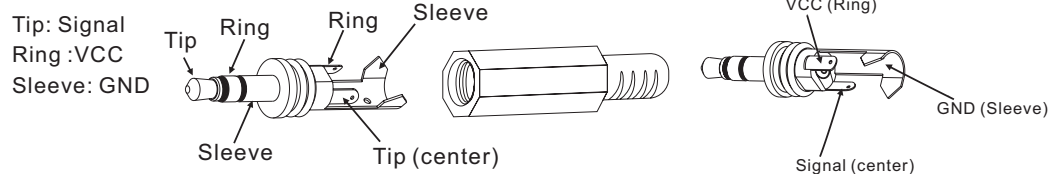

SB-100 Receiver and SB-101 Transmitter The DISTANCE maximum ~ 984 feet (300M)

Pin configuration for IR Receiver 6 feet (2M) cable such as SB-100C compatible

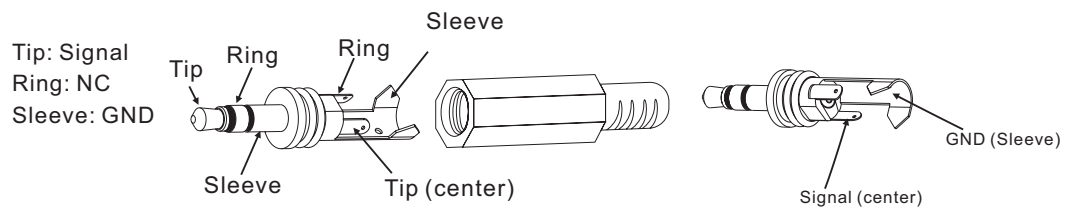

SB-100 Receiver and SB-101C Transmitter The DISTANCE maximum ~ 984 feet (300M)

**Note:** The External IR jack has voltage on the "Ring" portion of a 3-conductor plug. You must use a 3-conductor plug (aka: stereo plug). Using a 2-conductor plug will short out the power supply. Always make connections with the switcher power off.



# TYPICAL APPLICATION - SWITCH CONTROL

## INSTALLING DIAGRAM

### Samples Connection:

- Using IR External or **RS-232** command to control Switcher SB-5669CK via a PC or use extender **Receiver** (SB-100) to transmit the SB-5669CK's IR signal to control switch I/O.
- Switch control via Bi-Directional IR, RS-232 and Ethernet.

### NOTE:

- Switcher IR in External port: Use SB-100 IR signal Receiver & transmit IR signal to control switcher
- Control Switch via a PC RS-232
- Control Switch via a PC Ethernet

HDMI DISPLAY TV

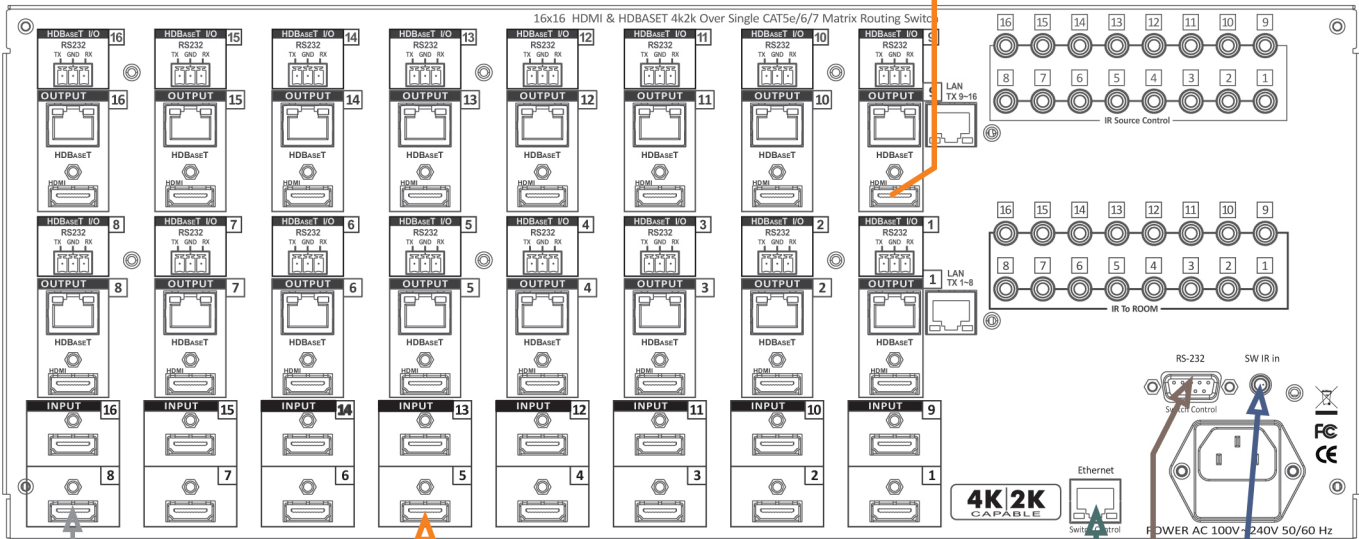

HDMI cable in

HDMI cable in



HD Satellite Receiver



Blu-ray



PC Ethernet To Control Switcher

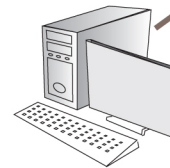

PC RS232 To Control Switcher



IR Extender Cable



SB-100 IR-Receiver



SW-HD16CK

Application IR, RS-232 and Ethernet to switch control.

# TYPICAL APPLICATION - HDBASET™ IR MATRIX ROUTING CONTROL

## INSTALLING DIAGRAM

### Samples Connection:

HDBaseT™ IR return (From Room) will follow the video source. In this example, the IR remote for the projector is connected to port#2 “IR To Room.” From the SB-6335R5 (PoH), the IR Output is connected to the projector. This allows remote operation of the projector from the SB-5669CKP. The IR control for source devices uses the same port number on “IR Source” as the source device connection. **In this example**, the Blu-Ray player is connected to Input port #5. Likewise, the IR to control the Blu-Ray player is connected to port #5.

IR source device control will follow the video source selected. Connect the IR emitter SB-101 or SB-101C to the corresponding port number as the source device, video Input port.

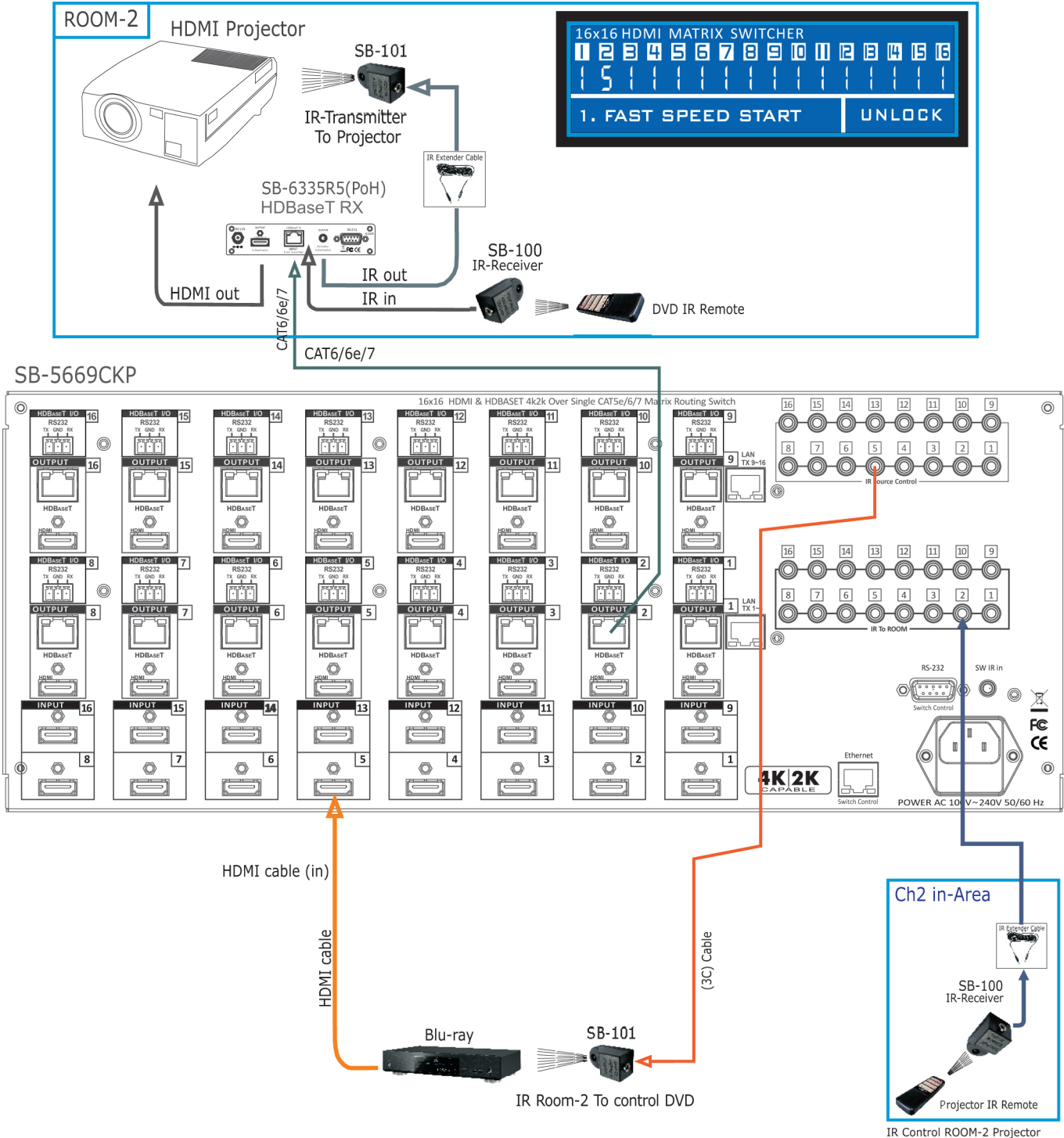

# TYPICAL APPLICATION - HDBASET™ CONTROL IR TO ROOM

## INSTALLING DIAGRAM

### Samples Connection:

Using HDBaseT™ to transmit the IR signal to control a room device via SB-5669CKP HDBaseT™ IR input (port #5) with an IR Receiver (SB-100) to transmit IR signal to the HDBaseT™ Receiver PoH (SB-6335R5) with IR Transmitters (SB-101) to control a room device display.

### NOTE:

1. IR Control Satellite Receiver Over HDBaseT™ Extender via CAT6/6a/7 cable:

- HDBaseT™ Transmitter with PoH: SB-5669CKP
- HDBaseT™ Receiver with PoH: SB-6335R5

2. IR Extender Transmitter (SB-101): Using SB-101 IR Transmitter to extend IR signal to a satellite receiver

\* HDBaseT™ extender uses a single category CAT6/6a/7 cable.

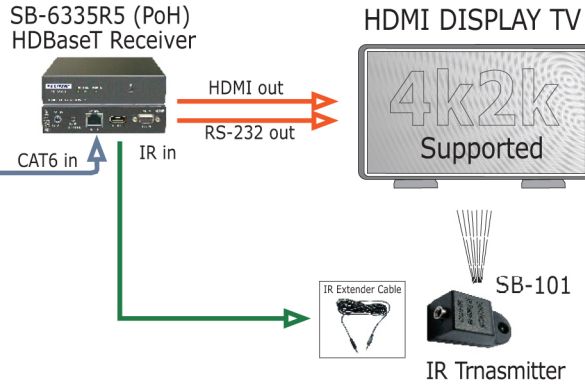

CATx(6/6a/7) Extension Cable Limited to ~328 feet (100M) Maximum.

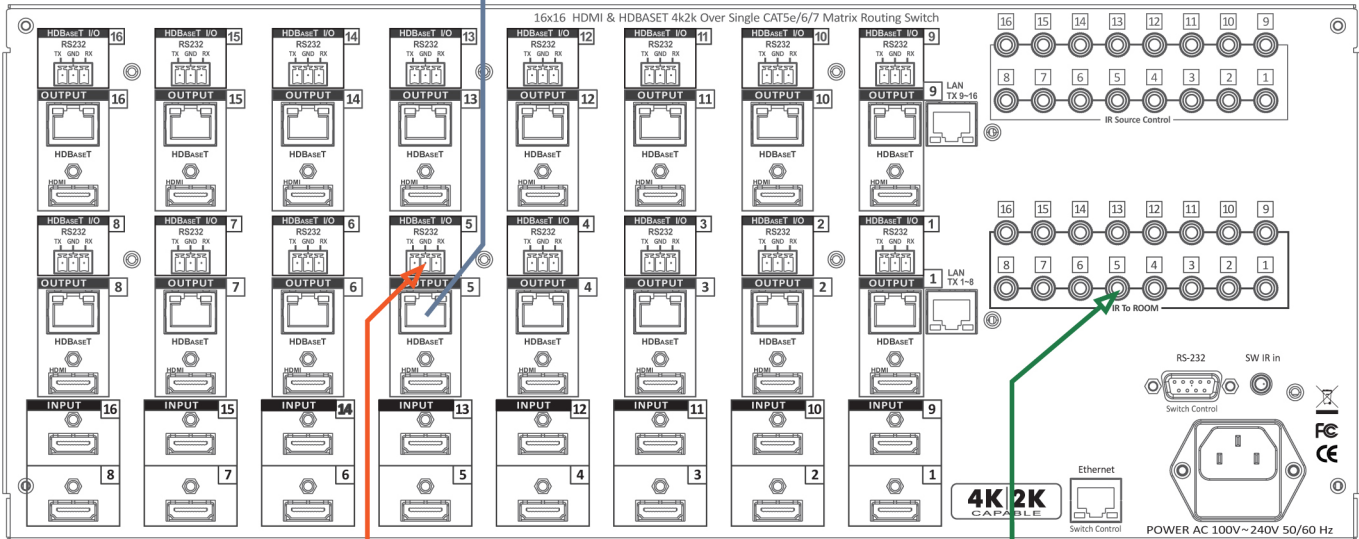

# TYPICAL APPLICATION - HDBASET™ CONTROL RS-232 & LAN

## INSTALLING DIAGRAM

### Samples Connection:

Using HDBaseT™ RS-232, HDBaseT™ to link LAN (HDBT #1~#8) and LAN (HDBT #9~#16) via the SB-5669CKP HDBaseT™ Transmitter (PoE) & HDBaseT™ Receiver PoE (SB-6335R) to control a projector or link LAN.

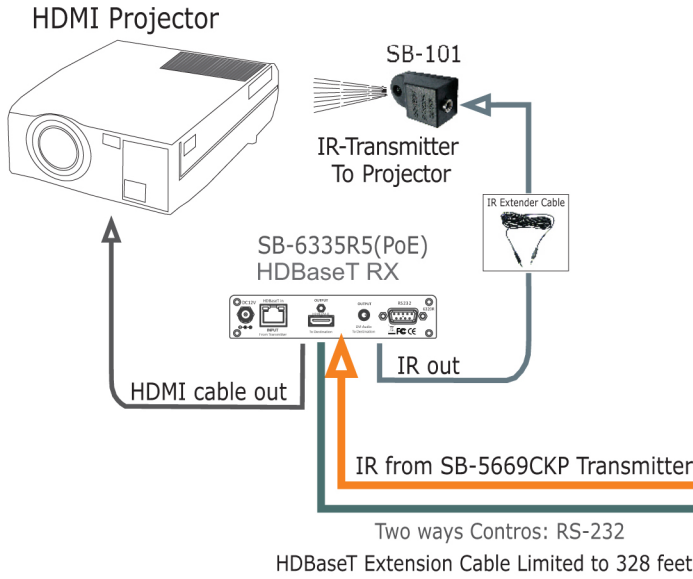

### NOTE:

1. IR Control Projector Over HDBaseT™ Extender:  
SB-5669CKP HDBaseT™ Transmitter (PoE)  
SB-6335R HDBaseT™ Receiver (PoE)
2. Projector RS-232 Control by a PC via HDBaseT™ Extender
3. Projector IR control via HDBaseT™ Receiver IR out
4. IR Extender Transmitter (SB-101): Use SB-101 IR Transmitter sends IR signal to the Projector

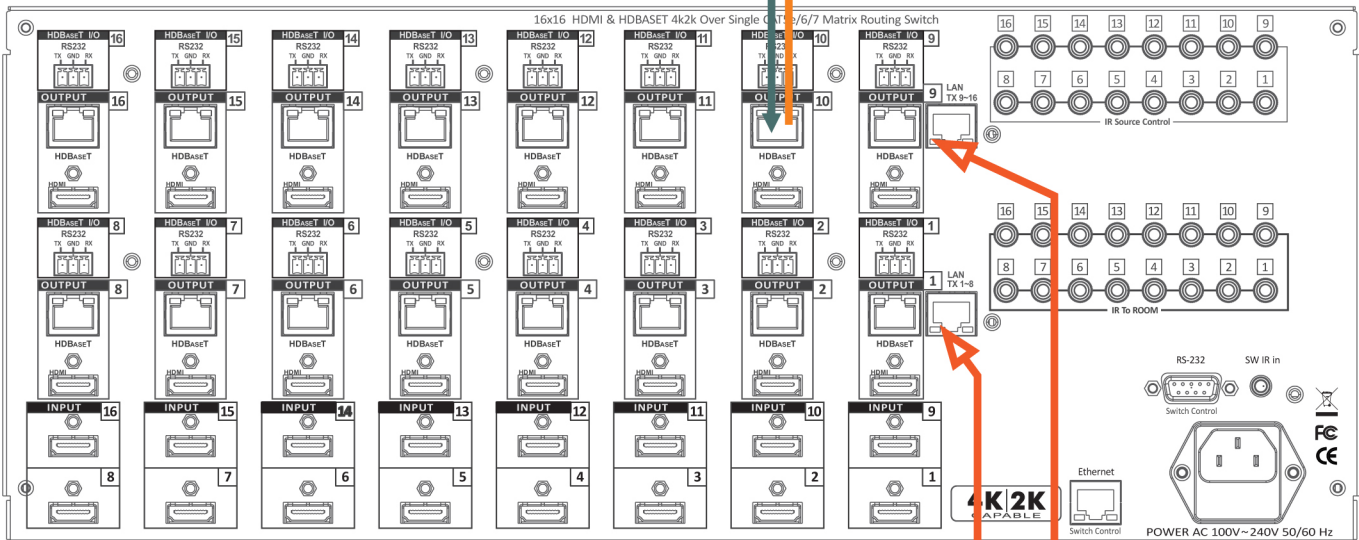

Two ways Contros: RS-232, IR in/out

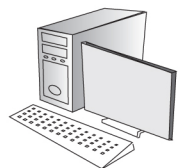

PC RS232 Control

LAN link : HDBaseT #1~#8 ports



PC connect to LAN

LAN link : HDBaseT #9~#16 ports



PC connect to LAN



# HDBASET™ APPLICATION - TRANSMITTER & RECEIVER

## APPLICATION

HDBaseT™ Matrix Switcher using HDBaseT™ Transmitters & Receiver (Sold separately).

### HDBaseT Transmitter with PoE

SB-6335T5 Distance:Max.100M



FRONT PANEL :

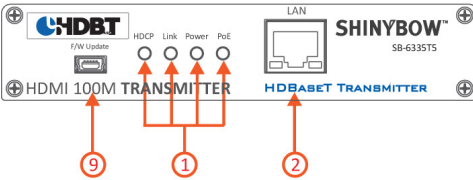

1. Status via LED Show out : HDCP, Link, Power & PoE.
2. 1x Ethernet path to HDBaseT Receiver.
3. DC input : 48V, with PoE Transmitter.
4. RJ-45 out : HDBaseT signal output to HDBaseT Receiver.

#### INPUTS:

1. 1x HDMI source.
2. 1x F/W update.

#### OUTPUTS:

1. 1x HDBaseT out (PoE 48VDC).

#### Controls:

1x RS-232, 1x IR in, 1x IR out, 1x LAN (Ethernet)

REAR PANEL :

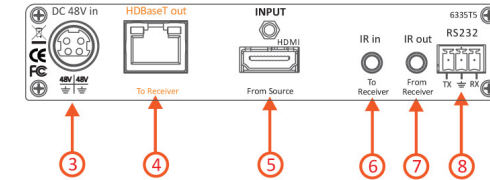

5. HDMI in : HDMI signal input from HDMI source device.
6. IR in : IR signal to HDBaseT Receiver.
7. IR out : IR signal from HDBaseT Receiver
8. RS-232 i/o : RS-232 series interface control via a PC.
9. USB in : F/W Update.

### HDBaseT Receiver with PoE

SB-6335R5 Distance:Max.100M



FRONT PANEL : HDBaseT 100M Receiver

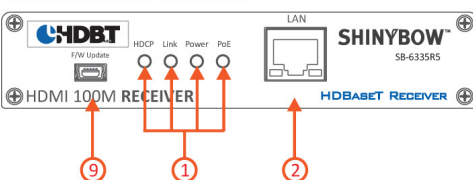

1. Status via LED Show out : HDCP, Link, Power & PoE.
2. 1x Ethernet path to HDBaseT Transmitter.
3. Extra DC input : 12V, Transmitter without support Power.
4. RJ-45 in : HDBaseT signal input from HDBaseT Transmitter.

#### INPUTS:

1. 1x HDBaseT in (PoE).
2. 1x F/W Update.

#### OUTPUTS:

1. 1x HDMI out.

#### Controls:

1x RS-232, 1x IR in, 1x IR out, 1x LAN (Ethernet)

REAR PANEL : HDBaseT 100M Receiver

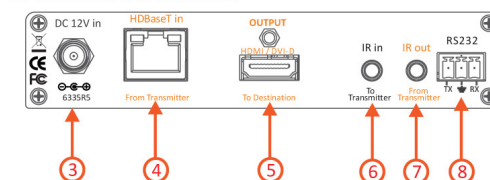

5. HDMI out : HDMI signal output to destination HDMI device.
6. IR in : IR signal to HDBaseT Transmitter.
7. IR out : IR signal from HDBaseT Transmitter.
8. RS-232 i/o : RS-232 series interface control via a PC.
9. USB in : F/W Update.

Supports HDBaseT™ Extender by Transmitter and Receiver via HDBaseT™ CAT6/6a/7 cable.



# HDBASET™ APPLICATION

## APPLICATION

### Optional 19 inch Rack Mount Bracket for SB-6335T and/or SB-6335R:

Complete 19 inch 4U rack mount of SB-6069  
**Install Application:** SB-6335T/R

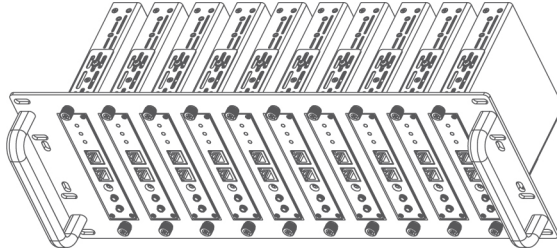

### SB-6069 (optional) SB-6335T/R 19 INCH 4U-10P RACK MOUNT

**Model No.:** #4U-10p-M130MM  
 SB-6335T/R 4U Ear mount pairs  
**Parts No.:** MEER6069ER13000

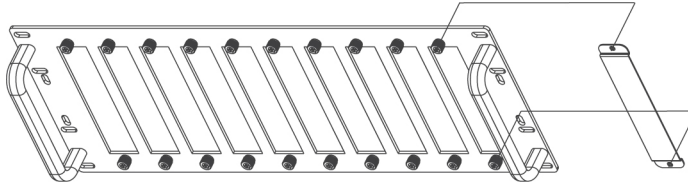

**Model No.:** #4U-10p-M130MM-COV  
 SB-6335T/R 4U Ear mount pairs  
**Parts No.:** MEER6069ER11000



### SB-6335T/R 19 INCH 4U-10P RACK MOUNT

**Model No.:** #WM-1INCH-130MM  
 SB-6335T/R 4U Ear mount pairs  
**Parts No.:** MEER6320ER11000

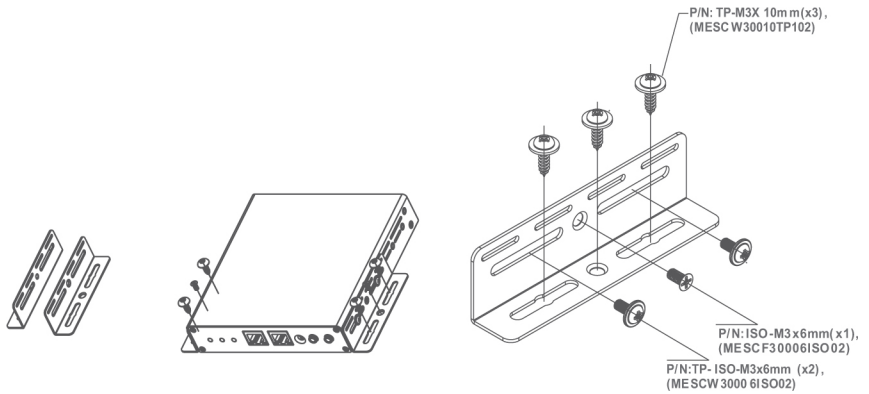

**Model No.:** #4U-10p-M130MM-EAR  
 SB-6335T/R 4U Ear mount pairs  
**Parts No.:** MEER6335ER11001

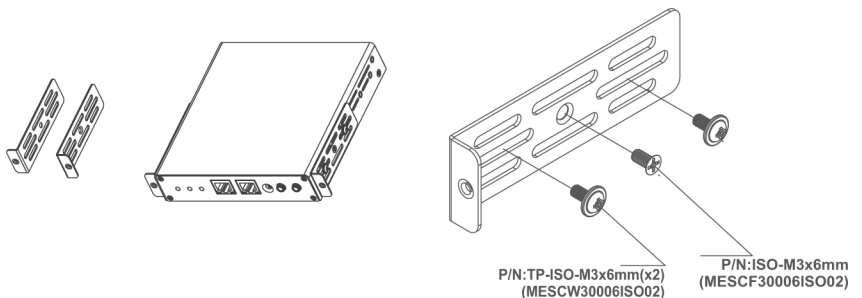

Supports HDBaseT™ Extender with Transmitter and Receiver via HDBaseT™ CAT6/6a/7 cable.

## RACKMOUNT (OPTIONAL)

---

**SB-6075A:** SB-6335T/R 19 INCH 1RU-1UNIT RACK MOUNT

**Model No.:** #1U-1p-L440-44MM



**SB-6075B:** SB-6335T/R 19 INCH 1RU-2UNIT RACK MOUNT

**Model No.:** #1U-2p-L440-44MM

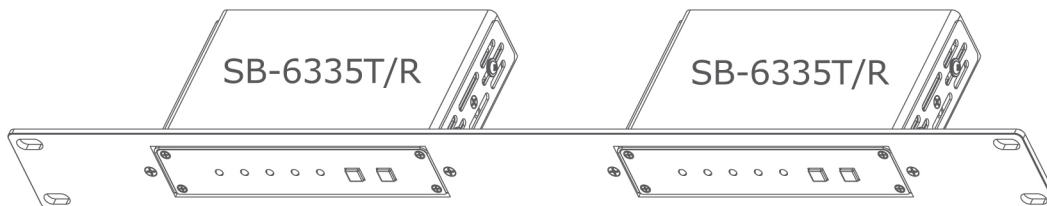

**SB-6069:** SB-6335T/R 19 INCH 4U-10P RACK MOUNT

**Model No.:** #4U-10p-L130MM

SB-6335T/R 4U Ear mount pairs

**Parts No.:** MEER6069ER13000

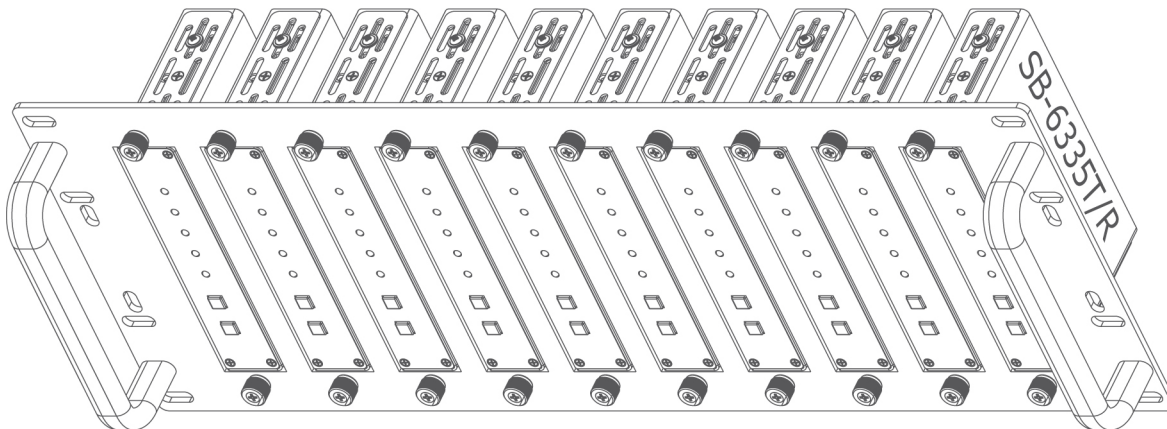

THIS PAGE IS INTENTIONALLY LEFT BLANK.

THIS PAGE IS INTENTIONALLY LEFT BLANK.

# LIMITED WARRANTY

PLEASE READ THE FOLLOWING TERMS AND CONDITIONS CAREFULLY BEFORE USING THIS HARDWARE, COMPONENTS AND SOFTWARE PROVIDED BY, THROUGH OR UNDER SHINYBOWUSA, INC (COLLECTIVELY, THE "PRODUCT"). By using installing or using the Product, you unconditionally signify your agreement to these Terms and Conditions. If you do not agree to these Terms and Conditions, do not use the Product and return the Product to SHINYBOWUSA, Inc. at the return address set forth on the Product's packing label at your expense. SHINYBOWUSA, Inc. may modify these Terms and Conditions at anytime, without notice to you.

## RESTRICTIONS ON USE OF THE PRODUCT

It is your responsibility to read and understand the installation and operation instructions, both verbal and in writing, provided to you with respect to the Product. You are authorized to use the Product solely in connection with such instructions. Any use of the Product not in accordance with such instructions shall void any warranty pertaining to the Product. Any and all damages that may occur in the use of the Product that is not strictly in accordance with such instructions shall be borne by you and you agree to indemnify and hold harmless SHINYBOWUSA, Inc. from and against any such damage.

The Product is protected by certain intellectual property rights owned by or licensed to SHINYBOWUSA. Any intellectual property rights pertaining to the Product are licensed to you by SHINYBOWUSA, Inc. and/or its affiliates, including any manufacturers or distributors of the Product (collectively, "SHINYBOWUSA") for your personal use only, provided that you do not change or delete any proprietary notices that may be provided with respect to the Product.

The Product is sold to you and any use of any associated intellectual property is deemed to be licensed to you by SHINYBOWUSA for your personal use only. SHINYBOWUSA does not transfer either the title or the intellectual property rights to the Product and SHINYBOWUSA retains full and complete title to the intellectual property rights therein. All trademarks and logos are owned by SHINYBOWUSA or its licensors and providers of the Product, and you may not copy or use them in any manner without the prior written consent of SHINYBOWUSA, which consent may be withheld at the sole discretion of SHINYBOWUSA.

The functionality and usability of the Product is controlled by SHINYBOWUSA, Inc. from its offices within the State of Texas, United States of America. SHINYBOWUSA makes no representation that materials pertaining to the Product are appropriate or available for use in other locations other than the shipping address you provided with respect thereto. You are advised that the Product may be subject to U.S. export controls.

## DISCLAIMERS AND LIMITATION OF LIABILITY

SHINYBOWUSA may change or modify the Product at any time, from time to time.

THE PRODUCT IS PROVIDED "AS IS" AND WITHOUT WARRANTIES OF ANY KIND EITHER EXPRESS OR IMPLIED. SHINYBOWUSA DOES NOT WARRANT OR MAKE ANY REPRESENTATIONS REGARDING THE USE OR THE RESULTS OF THE USE OF THE PRODUCT'S CORRECTNESS, ACCURACY, RELIABILITY, OR OTHERWISE.

SHINYBOWUSA has no duty or policy to update any information or statements pertaining to the Product and, therefore, such information or statements should not be relied upon as being current as of the date you use the Product. Moreover, any portion of the materials pertaining to the Product may include technical inaccuracies or typographical errors. Changes may be made from time to time without notice with respect to the Product.

TO THE FULLEST EXTENT PERMISSIBLE PURSUANT TO APPLICABLE LAW, SHINYBOWUSA DISCLAIMS ALL WARRANTIES, EXPRESS OR IMPLIED, INCLUDING, BUT NOT LIMITED TO IMPLIED WARRANTIES OF MERCHANTABILITY, FITNESS FOR A PARTICULAR PURPOSE AND NON-INFRINGEMENT. SHINYBOWUSA DOES NOT WARRANT THE ACCURACY, COMPLETENESS OR USEFULNESS OF ANY INFORMATION WITH RESPECT TO THE PRODUCT. SHINYBOWUSA DOES NOT WARRANT THAT THE FUNCTIONS PERTAINING TO THE PRODUCT WILL BE ERROR-FREE, THAT DEFECTS WITH RESPECT TO THE PRODUCT WILL BE CORRECTED, OR THAT THE MATERIALS PERTAINING THERETO ARE FREE OF DEFECTS OR OTHER HARMFUL COMPONENTS. SHINYBOWUSA WILL USE ITS REASONABLE EFFORTS TO CORRECT ANY DEFECTS IN THE PRODUCT UPON TIMELY WRITTEN NOTICE FROM YOU NOT TO EXCEED 10 BUSINESS DAYS AFTER RECEIPT BY YOU OF THE PRODUCT, BUT YOU (AND NOT SHINYBOWUSA) ASSUME THE ENTIRE COST OF ALL NECESSARY SERVICING, REPAIR AND CORRECTION THAT WAS CAUSED BY YOU UNLESS OTHERWISE AGREED TO IN A SEPARATE WRITING BY SHINYBOWUSA.

UNDER NO CIRCUMSTANCES, INCLUDING, BUT NOT LIMITED TO, NEGLIGENCE, SHALL SHINYBOWUSA BE LIABLE FOR ANY SPECIAL OR CONSEQUENTIAL DAMAGES THAT RESULT FROM THE USE OF, OR THE INABILITY TO USE THE PRODUCT IN ACCORDANCE WITH ITS SPECIFICATIONS, EVEN IF SHINYBOWUSA OR ITS REPRESENTATIVES HAVE BEEN ADVISED OF THE POSSIBILITY OF SUCH DAMAGES. IN NO EVENT SHALL SHINYBOWUSA'S TOTAL LIABILITY TO YOU FROM ALL DAMAGES, LOSSES, AND CAUSES OF ACTION (WHETHER IN CONTRACT, OR OTHERWISE) EXCEED THE AMOUNT YOU PAID TO SHINYBOWUSA, IF ANY, FOR THE PRODUCT.

**END OF DOCUMENT**



122 Rose Ln. Suite 303 | Frisco, Texas 75034

1-877-SHINY-USA

1-877-744-6987

1-972-377-2508

[sales@shinybowusa.com](mailto:sales@shinybowusa.com)

[www.shinybowusa.com](http://www.shinybowusa.com)

**SHINYBOW™ USA**  
MULTIMEDIA AUDIO AND VISUAL