

# UDX series

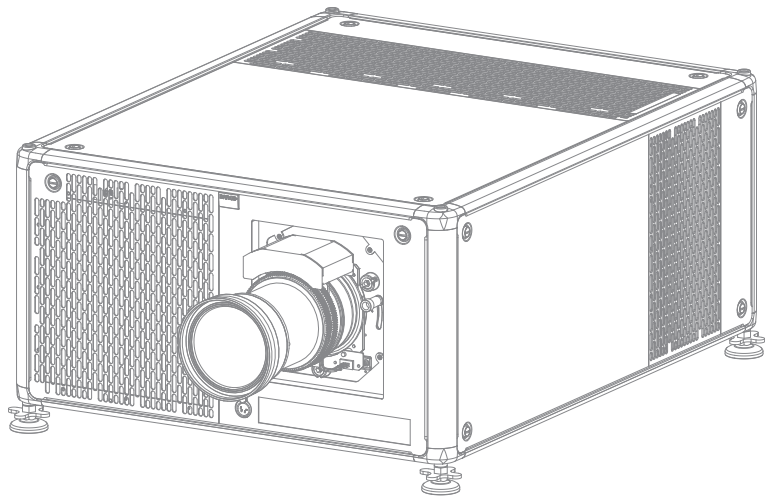

User Manual

## **Product revision**

Software Revision: 1.9.x

**Barco NV**  
Beneluxpark 21, 8500 Kortrijk, Belgium  
[www.barco.com/en/support](http://www.barco.com/en/support)  
[www.barco.com](http://www.barco.com)

## Copyright ©

All rights reserved. No part of this document may be copied, reproduced or translated. It shall not otherwise be recorded, transmitted or stored in a retrieval system without the prior written consent of Barco.

## Changes

Barco provides this manual 'as is' without warranty of any kind, either expressed or implied, including but not limited to the implied warranties or merchantability and fitness for a particular purpose. Barco may make improvements and/or changes to the product(s) and/or the program(s) described in this publication at any time without notice.

This publication could contain technical inaccuracies or typographical errors. Changes are periodically made to the information in this publication; these changes are incorporated in new editions of this publication.

The latest edition of Barco manuals can be downloaded from the Barco web site [www.barco.com](http://www.barco.com) or from the secured Barco web site <https://www.barco.com/en/signin>.

## Trademarks

Brand and product names mentioned in this manual may be trademarks, registered trademarks or copyrights of their respective holders. All brand and product names mentioned in this manual serve as comments or examples and are not to be understood as advertising for the products or their manufacturers.

## Product Security Incident Response

As a global technology leader, Barco is committed to deliver secure solutions and services to our customers, while protecting Barco's intellectual property. When product security concerns are received, the product security incident response process will be triggered immediately. To address specific security concerns or to report security issues with Barco products, please inform us via contact details mentioned on <https://www.barco.com/psirt>. To protect our customers, Barco does not publically disclose or confirm security vulnerabilities until Barco has conducted an analysis of the product and issued fixes and/or mitigations.

## Patent protection

Please refer to [www.barco.com/about-barco/legal/patents](http://www.barco.com/about-barco/legal/patents)

## Guarantee and Compensation

Barco provides a guarantee relating to perfect manufacturing as part of the legally stipulated terms of guarantee. On receipt, the purchaser must immediately inspect all delivered goods for damage incurred during transport, as well as for material and manufacturing faults Barco must be informed immediately in writing of any complaints.

The period of guarantee begins on the date of transfer of risks, in the case of special systems and software on the date of commissioning, at latest 30 days after the transfer of risks. In the event of justified notice of complaint, Barco can repair the fault or provide a replacement at its own discretion within an appropriate period. If this measure proves to be impossible or unsuccessful, the purchaser can demand a reduction in the purchase price or cancellation of the contract. All other claims, in particular those relating to compensation for direct or indirect damage, and also damage attributed to the operation of software as well as to other services provided by Barco, being a component of the system or independent service, will be deemed invalid provided the damage is not proven to be attributed to the absence of properties guaranteed in writing or due to the intent or gross negligence or part of Barco.

If the purchaser or a third party carries out modifications or repairs on goods delivered by Barco, or if the goods are handled incorrectly, in particular if the systems are operated incorrectly or if, after the transfer of risks, the goods are subject to influences not agreed upon in the contract, all guarantee claims of the purchaser will be rendered invalid. Not included in the guarantee coverage are system failures which are attributed to programs or special electronic circuitry provided by the purchaser, e.g. interfaces. Normal wear as well as normal maintenance are not subject to the guarantee provided by Barco either.

The environmental conditions as well as the servicing and maintenance regulations specified in this manual must be complied with by the customer.

## Federal Communications Commission (FCC Statement)

This equipment has been tested and found to comply with the limits for a class A digital device, pursuant to Part 15 of the FCC rules. These limits are designed to provide reasonable protection against harmful

interference when the equipment is operated in a commercial environment. This equipment generates, uses, and can radiate radio frequency energy and, if not installed and used in accordance with the instruction manual, may cause harmful interference to radio communications. Operation of this equipment in a residential area may cause harmful interference, in which case the user will be responsible for correcting any interference at his own expense

Changes or modifications not expressly approved by the party responsible for compliance could void the user's authority to operate the equipment

FCC responsible: Barco Inc.  
3059 Premiere Parkway Suite 400  
30097 Duluth GA, United States  
Tel: +1 678 475 8000

## **EMC notices**

### **EN55032/CISPR32 Class A MME (MultiMedia Equipment)**

**Warning :** This equipment is compliant with Class A of CISPR 32. In a residential environment this equipment may cause radio interference.

### **GB/T 9254 Class A ITE (Information Technology Equipment)**

**Warning :** This is a class A product. In a domestic environment this product may cause radio interference in which case the user may be required to take adequate measures.

### **BSMI Taiwan Class A statement:**

警告使用者：此為甲類資訊技術設備，於居住環境中使用，可能會造成射頻擾動，在此情況下，使用者會被要求採取某些適當的對策。

# Table of contents

<b>1 Safety</b>	<b>9</b>
1.1 General considerations	10
1.2 Important safety instructions	12
1.3 Product safety labels	16
1.4 High Brightness precautions: Hazard Distance (HD)	17
1.5 HD for fully enclosed projection systems	20
1.6 HD in function of modifying optics	21
<b>2 Pulse Remote Control Unit</b>	<b>23</b>
2.1 Remote control, battery installation	24
2.2 Remote control, protocol setup	26
2.3 Remote control, on/off button	27
2.4 Functionality overview	28
2.5 Functions of the “button pressed indicator”	29
2.6 Function of the RGB filter button	30
2.7 Displaying and Programming addresses into the RCU	31
2.8 Using the XLR connector of the RCU	32
2.9 Using the mini-jack connector of the RCU	33
2.10 Silicone protection sleeve for the RCU (optional)	34
<b>3 Input &amp; Communication</b>	<b>35</b>
3.1 Introduction	36
3.2 Local Keypad and LCD panel	37
3.3 Communication connections	38
3.4 Input source connections – Quad combo input Mark II	41
3.5 Input source connections – Quad combo input Mk I	46
3.6 Input source connections – Quad DP 1.2 Input board	50
3.7 Input source connections – SFP Input Board	52
3.8 LED and Button indication chart	56
3.9 Removal of an input board	57
3.10 Installation of an input board or a communication board	59
<b>4 Getting Started</b>	<b>61</b>
4.1 Power on projector	62
4.2 Switching to standby	64
4.3 Power off projector	65
4.4 Using the RCU	66
4.5 Projector Address	68
4.5.1 Controlling the projector	69
4.6 Quick setup via Direct access	70
4.7 Software update	72

<b>5</b>	<b>Graphic User Interface (GUI)</b>	<b>75</b>
5.1	Overview	76
5.2	Navigation	78
5.3	Test Patterns	80
<b>6</b>	<b>GUI – Source</b>	<b>81</b>
6.1	Displaying a single source	82
6.2	Displaying multiple sources: Stitched layouts	83
6.3	Connector Settings	85
<b>7</b>	<b>GUI – Image</b>	<b>87</b>
7.1	Setting image levels manually	88
7.2	Adjusting the sharpness	90
7.3	Adjusting the gamma correction	91
7.4	Setting the desired Gamma type	92
7.5	Digital Shift & Zoom	93
7.6	P7 Realcolor	96
7.7	Setting the output resolution	98
7.8	Displaying HDR content – Perceptual Quantizer (PQ)	99
<b>8</b>	<b>GUI – Installation</b>	<b>101</b>
8.1	Configuring the lens, optical zoom-focus	102
8.2	Configuring the lens, shift	103
8.3	Configuring the lens, Mid position	104
8.4	Laser ranging	105
8.5	Manipulating the rigging frame	107
8.6	Orientation	109
8.7	Warping	110
8.7.1	Warping – On/Off	111
8.7.2	Warping – Screen Size	112
8.7.3	Warping – 4 corners adjustment	114
8.7.4	Warping – Bow	116
8.7.5	Warping – Warp files	121
8.7.6	Warping – Latency control in a multi projector setup	123
8.8	Blending & masking	125
8.8.1	Blend & Mask	126
8.8.2	Blend Files	129
8.8.3	Basic black level adjustment	131
8.8.4	Black Level Files	133
8.8.5	RGB adjustment	134
8.9	Laser illumination	136
8.10	Setting up the external cooler	137
8.11	Scaling modes	138
8.12	3D projection	140
8.12.1	Active Stereo & Passive Stereo	141
8.12.2	Setup process 3D projection	142
8.12.3	Connection possibilities	143
8.12.4	Choosing the desired Display Setup	144
8.12.5	3D emitter Setup	146
<b>9</b>	<b>GUI – Macro's and projector profiles</b>	<b>147</b>
9.1	Saving the current projector settings in a profile	148
9.2	Assigning a created projector profile to a preset	150
9.3	Deleting a projector profile	152

<b>10 GUI – System Settings</b> .....	<b>153</b>
10.1 Communication, LAN setup .....	154
10.1.1 Introduction to a Network connection .....	155
10.1.2 Wired IP address set up .....	156
10.1.3 Wireless IP address set up .....	158
10.2 IR control .....	161
10.2.1 Broadcast address .....	162
10.2.2 Projector address .....	163
10.2.3 IR sensors .....	164
10.3 Setting a custom projector name .....	165
10.4 DMX .....	166
10.5 Front XLR output voltage control .....	168
10.6 GSM configuration .....	169
10.7 Themes .....	170
10.8 Setting the measurement system .....	171
10.9 Disabling Standby mode .....	172
10.10 Lens features .....	173
10.11 Controlling the backlight of the LCD Display .....	174
10.12 Reset .....	175
10.13 Lens Calibration .....	177
10.14 Flex brightness .....	178
10.15 Rigging frame Calibration .....	180
10.16 Electronic Convergence .....	181
10.17 Advanced Settings .....	183
10.17.1 Advanced Settings – Color .....	184
10.17.2 Advanced Settings – Statistics .....	185
10.17.3 Checking the status of the Laser Banks .....	186
<b>11 Status menu</b> .....	<b>189</b>
11.1 Status menu overview .....	190
<b>12 Maintenance</b> .....	<b>191</b>
12.1 Cleaning the lens .....	192
12.2 Cleaning the exterior of the projector .....	193
<b>A Specifications</b> .....	<b>195</b>
A.1 Specifications of the UDX-4K40 .....	196
A.2 Specifications of the UDX-4K32 .....	198
A.3 Specifications of the UDX-4K22 .....	200
A.4 Specifications of the UDX-W40 .....	202
A.5 Specifications of the UDX-W32 .....	204
A.6 Specifications of the UDX-W26 .....	206
A.7 Specifications of the UDX-W22 .....	208
A.8 Specifications of the UDX-U40 .....	210
A.9 Specifications of the UDX-U32 .....	212
A.10 Dimensions of a UDX .....	214
A.11 Dimensions of the rigging frame .....	215
A.12 Dimensions of the flight case .....	216
A.13 Technical Regulations .....	217
<b>B Environmental information</b> .....	<b>219</b>
B.1 Disposal information .....	220
B.2 Turkey RoHS compliance .....	221
B.3 Contact information .....	222

<b>C</b>	<b>Overview video timings for video interfaces .....</b>	<b>223</b>
C.1	Overview video timings .....	224
C.2	Overview video timings SDI Inputs .....	226
C.3	Overview video timings HDMI 2.0 inputs .....	227
C.4	Overview video timings DisplayPort 1.2 inputs .....	229
C.5	Overview video timings HDBaseT inputs .....	232
<b>D</b>	<b>DMX chart .....</b>	<b>235</b>
D.1	DMX chart input board positioning .....	236
D.2	DMX chart, Basic .....	237
D.3	DMX chart, Extended .....	238



# Safety

# 1

## About this document

Read this document attentively. It contains important information to prevent personal injury while installing and using the UDX projector. Furthermore, it includes several cautions to prevent damage to the UDX projector. Ensure that you understand and follow all safety guidelines, safety instructions and warnings mentioned in this chapter before installing the UDX projector.

## Clarification of the term “UDX” used in this document

When referring in this document to the term “UDX” means that the content is applicable for following Barco products:

- UDX 4K22
- UDX 4K26
- UDX 4K32
- UDX 4K40
- UDX U32
- UDX U40
- UDX W22
- UDX W26
- UDX W32
- UDX W40

## Model certification name

- UDX



Barco provides a guarantee relating to perfect manufacturing as part of the legally stipulated terms of guarantee. Observing the specification mentioned in this chapter is critical for projector performance. Neglecting this can result in loss of warranty.

## 1.1 General considerations



**WARNING:** Be aware of suspended loads.



**WARNING:** Wear a hard hat to reduce the risk of personal injury.



**WARNING:** Be careful while working with heavy loads.



**WARNING:** Mind your fingers while working with heavy loads.



**WARNING:** In case of optical radiation emergency, please disconnect the device from the mains current; this by employing the mains switch. In case the mains switch is not easily accessible, the projectors shall be disconnected by other means for example the mains junction box. It is advised to employ the shutter or select a black image on the projector in order to reduce the risk of the emergency.

### General safety instructions

- Before operating this equipment please read this manual thoroughly and retain it for future reference.
- Installation and preliminary adjustments should be performed by qualified Barco personnel or by authorized Barco service dealers.
- All warnings on the projector and in the documentation manuals should be adhered to.
- All instructions for operating and use of this equipment must be followed precisely.
- All local installation codes should be adhered to.

### Notice on safety

This equipment is built in accordance with the requirements of the international safety standards IEC60950-1, EN60950-1, UL60950-1 and CAN/CSA C22.2 No.60950-1, which are the safety standards of information technology equipment including electrical business equipment. These safety standards impose important requirements on the use of safety critical components, materials and insulation, in order to protect the user or operator against risk of electric shock and energy hazard and having access to live parts. Safety standards also impose limits to the internal and external temperature rises, radiation levels, mechanical stability and strength, enclosure construction and protection against the risk of fire. Simulated single fault condition testing ensures the safety of the equipment to the user even when the equipment's normal operation fails.

### Notice on optical radiation

This projector embeds extremely high brightness (radiance) lasers; this laser light is processed through the projector's optical path. Native laser light is not accessible by the end user in any use case. The light exiting the projection lens has been diffused within the optical path, representing a larger source and lower radiance value than native laser light. Nevertheless the projected light represents a significant risk for the human eye and skin when exposed directly within the beam. This risk is not specifically related to the characteristics of laser light but solely to the high thermal induced energy of the light source; which is equivalent with lamp based systems.

Thermal retinal eye injury is possible when exposed within the Hazard Distance (HD). The HD is defined from the projection lens surface towards the position of the projected beam where the irradiance equals the maximum permissible exposure as described in the chapter "Hazard Distance".



**WARNING:** No direct exposure to the beam within the hazard distance shall be permitted, RG3 (Risk Group 3) IEC EN 62471-5:2015



**CAUTION:** Use of controls or adjustments or performance of procedures other than those specified herein may result in hazardous radiation exposure.

## Notice on laser radiation

The laser distance meter that is optional equipment for this projector can emit a class 2 laser ranging beam of 0.95 mW / 638 nm. When installed correctly, this distance meter is located on the front side of the projector (see Image 1-1). The laser beam can be enabled by either pressing the button on the equipment, via the projector menu, or via the projector software. Thermal retinal eye injury is possible when staring into the laser ranging beam.

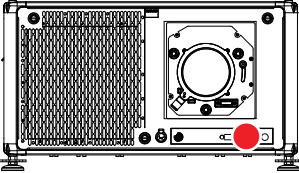

Image 1-1: Location of the laser distance meter



**WARNING:** Laser Radiation — Do not stare into laser ranging beam, Class 2 IEC EN 60825-1:2014

## Users definition

Throughout this manual, the term SERVICE PERSONNEL refers to persons having appropriate technical training and experience necessary to be knowledgeable of potential hazards to which they are exposed (including, but not limited to HIGH VOLTAGE ELECTRIC and ELECTRONIC CIRCUITRY and HIGH BRIGHTNESS PROJECTORS) in performing a task, and of measures to minimize the potential risk to themselves or other persons. The term USER and OPERATOR refers to any person other than SERVICE PERSONNEL, AUTHORIZED to operate professional projection systems.

The UDX projector is intended "FOR PROFESSIONAL USE ONLY" by AUTHORIZED PERSONNEL familiar with potential hazards associated with high voltage, high intensity light beams and high temperatures generated by the light source and associated circuits. Only qualified SERVICE PERSONNEL, knowledgeable of such risks, are allowed to perform service functions inside the product enclosure.

## 1.2 Important safety instructions

### To prevent the risk of electrical shock

- This product should be operated from a mono phase AC power source. Ensure that the mains voltage and capacity matches the projector electrical ratings (120-160V / 200-240V (+/- 10%), 20A, 50-60Hz). If you are unable to install the AC requirements, contact your electrician. Do not defeat the purpose of the grounding.
- This apparatus must be grounded (earthed) via the supplied 3 conductor AC power cable. If you are unable to insert the plug into the outlet, contact your electrician to replace your obsolete outlet. Do not defeat the purpose of the grounding-type plug.
- Do not allow anything to rest on the power cord. Do not locate this product where persons will walk on the cord. To disconnect the cord, pull it out by the plug. Never pull the cord itself.
- Use only the power cord supplied with your device. While appearing to be similar, other power cords have not been safety tested at the factory and may not be used to power the device. For a replacement power cord, contact your dealer.
- Do not operate the projector with a damaged cord. Replace the cord.
- Do not operate the projector if the projector has been dropped or damaged - until it has been examined and approved for operation by qualified service personnel.
- Position the cord so that it will not be tripped over, pulled, or contact hot surfaces.
- If an extension cord is necessary, a cord with a current rating at least equal to that of the projector should be used. A cord rated for less amperage than the projector may overheat.
- Never push objects of any kind into this product through cabinet slots as they may touch dangerous voltage points or short out parts that could result in a risk of fire or electrical shock.
- Do not expose this projector to rain or moisture.
- Do not immerse or expose this projector in water or other liquids.
- Do not spill liquid of any kind on this projector.
- Should any liquid or solid object fall into the cabinet, unplug the set and have it checked by qualified service personnel before resuming operations.
- Do not disassemble this projector, always take it to qualified service personnel when service or repair work is required.
- Do not use an accessory attachment which is not recommended by the manufacturer.
- Lightning - For added protection for this video product during a lightning storm, or when it is left unattended and unused for long periods of time, unplug it from the wall outlet. This will prevent damage to the device due to lightning and AC power-line surges.

### To prevent personal injury

- To prevent injury and physical damage, always read this manual and all labels on the system before powering the projector or adjusting the projector.
- To prevent injury, take note of the weight of the projector. Minimum 2 persons are needed to carry the projector. The projector weights about  $\pm 90$  kg ( $\pm 198$  lbs) without lens and rigging frame.
- To prevent injury, ensure that the lens and all covers are correctly installed. See installation procedures.
- **Warning:** high intensity light beam. NEVER look into the lens ! High luminance could result in damage to the eye.
- **Warning: extremely high brightness projector:** This projector embeds extremely high brightness (radiance) lasers; this laser light is processed through the projectors optical path. Native laser light is not accessible by the end user in any use case. The light exiting the projection lens has been diffused within the optical path, representing a larger source and lower radiance value than native laser light. Nevertheless the projected light represents a significant risk for the human eye when exposed directly within the beam. This risk is not specific related to the characteristics of laser light but solely to the high thermal induced energy of the light source; which is comparable with lamp based systems. Thermal retinal eye injury is possible when exposed within the Hazard Distance. The Hazard Distance (HD) is defined from the projection lens surface towards the position of the projected beam where the irradiance equals the maximum permissible exposure as described in the chapter "High Brightness precautions: Hazard Distance (HD)", page 17.
- High Brightness Warning: The projector light source may not be switched on or the shutter must be closed when no projection lens is installed.
- Based on international requirements, no person is allowed to enter the projected beam within the zone between the projection lens and the related Hazard Distance (HD). This shall be physically impossible by

creating sufficient separation height or by placing optional barriers. Within the restricted area operator training is considered sufficient. The applicable separation heights are discussed in “High Brightness precautions: Hazard Distance (HD)”, page 17.

- **Warning:** Laser radiation. Do not stare into laser ranging beam. Class 2 laser beam could result in damage to the eye.
- Don't put your hand in front of the beam.
- Before attempting to remove any of the projector's covers, you must turn off the projector and disconnect from the wall outlet.
- When required to switch off the projector, to access parts inside, always disconnect the power cord from the power net.
- **The power input at the projector side is considered as the disconnect device. When required to switch off the projector, to access parts inside, always disconnect the power cord at the projector side. In case the power input at the projector side is not accessible (e.g. ceiling mount), the socket outlet supplying the projector shall be installed nearby the projector and be easily accessible, or a readily accessible general disconnect device shall be incorporated in the fixed wiring.**
- Never stack more than 2 UDX projectors in a hanging configuration (truss) and never stack more than 3 UDX projectors in a base stand configuration (table mount).
- When using the projector in a hanging configuration, always mount 2 safety cables. See installation manual for the correct use of these cables.
- Do not place this equipment on an unstable cart, stand, or table. The product may fall, causing serious damage to it and possible injury to the user.
- It is hazardous to operate without lens or shield. Lenses or shields shall be changed if they have become visibly damaged to such an extent that their effectiveness is impaired. For example by cracks or deep scratches.
- **Cooling liquid circuit.** The projector contains a cooling circuit filled with Mono-ethylene glycol (1,2-ethane diol) and inhibitors in aqueous solution (34% active). When the cooling circuit leaks, switch off the device and contact qualified service personnel. The liquid is not for household use. Keep out of reach of children. Harmful by oral intake. Avoid exposure to pregnant women. Avoid contact with eyes, skin and clothing. Avoid inhale of the noxious fumes.
- Never point or allow light to be directed on people or reflective objects within the HD zone.
- All operators shall have received adequate training and be aware of the potential hazards.
- In case of using an external cooling system position the hoses of the cooling system so that they will not be tripped over, pulled, or contact hot surfaces.

## To prevent fire hazard

- Do not place flammable or combustible materials near the projector!
- Barco large screen projection products are designed and manufactured to meet the most stringent safety regulations. This projector radiates heat on its external surfaces and from ventilation ducts during normal operation, which is both normal and safe. Exposing flammable or combustible materials into close proximity of this projector could result in the spontaneous ignition of that material, resulting in a fire. For this reason, it is absolutely necessary to leave an “exclusion zone” around all external surfaces of the projector whereby no flammable or combustible materials are present. The exclusion zone must be not less than 40 cm (16”) for this projector.
- Do not place any object in the projection light path at close distance to the projection lens output. The concentrated light at the projection lens output may result in damage, fire or burn injuries.
- Ensure that the projector is solidly mounted so that the projection light path cannot be changed by accident.
- Do not cover the projector or the lens with any material while the projector is in operation. . Mount the projector in a well ventilated area away from sources of ignition and out of direct sun light. Never expose the projector to rain or moisture. In the event of fire, use sand, CO<sub>2</sub> or dry powder fire extinguishers. Never use water on an electrical fire. Always have service performed on this projector by authorized Barco service personnel. Always insist on genuine Barco replacement parts. Never use non-Barco replacement parts as they may degrade the safety of this projector.
- Slots and openings in this equipment are provided for ventilation. To ensure reliable operation of the projector and to protect it from overheating, these openings must not be blocked or covered. The openings should never be blocked by placing the projector too close to walls, or other similar surface. This projector should never be placed near or over a radiator or heat register. This projector should not be placed in a built-in installation or enclosure unless proper ventilation is provided.
- Projection rooms must be well ventilated or cooled in order to avoid build up of heat. It is necessary to vent hot exhaust air from projector and cooling system to the outside of the building.

- Let the projector cool completely before storing. Remove cord from the projector when storing.

### To prevent battery explosion

- Danger of explosion if battery is incorrectly installed.
- Replace only with the same or equivalent type recommended by the manufacturer.
- For disposal of used batteries, always consult federal, state, local and provincial hazardous waste disposal rules and regulations to ensure proper disposal.

### To prevent projector damage

- The air filters of the projector must be cleaned or replaced on a regular basis. Cleaning the booth area would be monthly-minimum. Neglecting this could result in disrupting the air flow inside the projector, causing overheating. Overheating may lead to the projector shutting down during operation.
- The projector must always be installed in a manner which ensures free flow of air into its air inlets.
- If more than one projector is installed in a common projection booth, the exhaust air flow requirements are valid for EACH individual projector system. Note that inadequate air extraction or cooling will result in decreased life expectancy of the projector as a whole as well as causing premature failure of the lasers.
- In order to ensure that correct airflow is maintained, and that the projector complies with Electromagnetic Compatibility (EMC) and safety requirements, it should always be operated with all of its covers in place.
- Slots and openings in the cabinet are provided for ventilation. To ensure reliable operation of the product and to protect it from overheating, these openings must not be blocked or covered. The openings should never be blocked by placing the product on a bed, sofa, rug, or other similar surface. This product should never be placed near or over a radiator or heat register. The device should not be placed in a built-in installation or enclosure unless proper ventilation is provided.
- Ensure that nothing can be spilled on, or dropped inside the projector. If this does happen, switch off and remove all power from the projector. Do not operate the projector again until it has been checked by qualified service personnel.
- Do not block the projector cooling fans or free air movement around the projector.
- Do not use this equipment near water.
- **Special care for Laser Beams:** Special care should be used when DLP projectors are used in the same room as high power laser equipment. Direct or indirect hitting of a laser beam on to the lens can severely damage the Digital Mirror Devices™ in which case there is a loss of warranty.
- Never place the projector in direct sunlight. Sunlight on the lens can severely damage the Digital Mirror Devices™ in which case there is a loss of warranty.
- Save the original shipping carton and packing material. They will come in handy if you ever have to ship your equipment. For maximum protection, repack your set as it was originally packed at the factory.
- Unplug this product from the wall outlet before cleaning. Do not use liquid cleaners or aerosol cleaners. Use a damp cloth for cleaning. Never use strong solvents, such as thinner or benzene, or abrasive cleaners, since these will damage the cabinet. Stubborn stains may be removed with a cloth lightly dampened with mild detergent solution.
- To ensure the highest optical performance and resolution, the projection lenses are specially treated with an anti-reflective coating, therefore, avoid touching the lens. To remove dust on the lens, use a soft dry cloth. For lens cleaning follow the instructions precisely as stipulated in the projector manual.
- Only use **zoom** lenses of the Barco TLD+ series on the 4k models of the UDX. Using other lenses will damage the internal optics. For suitable fixed TLD+ lenses contact Barco or see Barco website.
- Allowed ambient temperature range:  $t_a = 0^{\circ}\text{C}$  (32°F) to 40 °C (104 °F)
- Rated humidity = 0% RH to 80% RH Non-condensed.

### On servicing

- Do not attempt to service this product yourself, as opening or removing covers may expose you to dangerous voltage potentials and risk of electric shock.
- Refer all servicing to qualified service personnel.
- Attempts to alter the factory-set internal controls or to change other control settings not specially discussed in this manual can lead to permanent damage to the projector and cancellation of the warranty.
- Remove all power from the projector and refer servicing to qualified service technicians under the following conditions:
  - When the power cord or plug is damaged or frayed.
  - If liquid has been spilled into the equipment.
  - If the product has been exposed to rain or water.

- If the product does not operate normally when the operating instructions are followed. Adjust only those controls that are covered by the operating instructions since improper adjustment of the other controls may result in damage and will often require extensive work by a qualified technician to restore the product to normal operation.
- If the product has been dropped or the cabinet has been damaged.
- If the product exhibits a distinct change in performance, indicating a need for service.
- Replacement parts: When replacement parts are required, be sure the service technician has used original Barco replacement parts or authorized replacement parts which have the same characteristics as the Barco original part. Unauthorized substitutions may result in degraded performance and reliability, fire, electric shock or other hazards. Unauthorized substitutions may void warranty.
- Safety check: Upon completion of any service or repairs to this projector, ask the service technician to perform safety checks to determine that the product is in proper operating condition.

### **Stacking/transporting UDX rental flight cases**



- Stack maximum 2 rental flight cases high. Never higher.
- Surface on which flight case is standing must be level to ensure that the total load is evenly spread out among the four wheels. The surface must also be able to support the load safely.
- Before stacking or transporting flight cases, check the wheels and their fixation screws for wear or defects.
- Before stacking or transporting flight cases, check that the four lock handles on each flight case are in good working order and locked securely.
- When stacked, make sure the wheels of the upper flight case are precisely positioned in the stacking dishes of the flight case below.
- Stacked flight cases may not be moved. Before stacking, the lower flight case must already be in its final resting position before placing the second upon it.
- Never stack loaded flight cases in a truck or other transport medium, unless each flight case is rigidly strapped tight.
- In the event of a wheel breaking, flight cases must be rigidly strapped tight to prevent a stack collapsing.
- Use an appropriate forklift to raise flight cases and take the necessary precautions to avoid personnel injury.

### **Safety Data Sheets for Hazardous Chemicals**

For safe handling information on chemical products, consult the Safety Data Sheet (SDS). SDSs are available upon request via [safetydatasheets@barco.com](mailto:safetydatasheets@barco.com).

# 1.3 Product safety labels

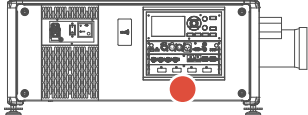
## Light beam related safety labels

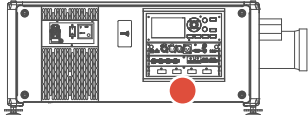
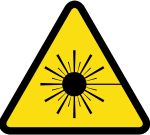
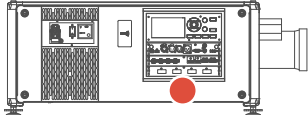
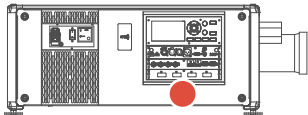
Label image	Label description	Label location
	Hazard RG3: not for household use symbol.	
	Hazard RG3: optical radiation warning symbol.	
	Hazard class 2: laser radiation warning symbol. 0.95mW 638nm	
<p><b>WARNING! DO NOT LOOK INTO THE BEAM. NO DIRECT EYE EXPOSURE TO THE PROJECTOR BEAM IS PERMITTED. LASER RADIATION - DO NOT STARE INTO LASER RANGING BEAM. RG3 IEC EN 62471-5:2015 CLASS 2 IEC EN 60825-1:2014. HAZARD DISTANCE: CONSULT SAFETY MANUAL.</b></p> <p>THIS PRODUCT IS IN CONFORMITY WITH PERFORMANCE STANDARDS FOR LASER PRODUCTS UNDER 21 CFR 1040, EXCEPT WITH RESPECT TO THOSE CHARACTERISTICS AUTHORIZED BY VARIANCE NUMBER 2016-V-0144 EFFECTIVE ON JUNE 7, 2017.</p> <p><b>警告! 嚴禁肉眼視線進入投影光域。眼睛請勿直接暴露在投影光域內。雷射光輻射 - 請勿凝視雷射光。RG3 IEC EN 62471-5 : 2015 CLASS 2 IEC EN 60825-1 : 2014. 危險距離:請參照安全手冊。</b></p> <p><b>警告! 勿觀看投影机光束。眼睛勿直接接觸可允許暴露的光束。激光輻射-勿直視激光範圍內光束。RG3 IEC EN 62471-5 : 2015 CLASS 2 IEC EN 60825-1 : 2014. 危害距離:請參考安全手冊。</b></p> <p><b>ATTENTION! NE PAS REGARDER LE FAISCEAU DU PROJECTEUR. EVITER TOUTE EXPOSITION DIRECTE DES YEUX AU FAISCEAU DU PROJECTEUR. RAYONNEMENT LASER - NE PAS REGARDER DANS LE FAISCEAU DU TELEMETRE. RG3 IEC EN 62471-5:2015 CLASS 2 IEC EN 60825-1:2014. DISTANCE DE SECURITE: CONSULTER LE MANUEL DE SECURITE.</b></p>		

**WARNING! DO NOT LOOK INTO THE LIGHT BEAM. NO DIRECT EYE EXPOSURE TO THE BEAM IS PERMITTED. LASER RADIATION - DO NOT STARE INTO LASER RANGING BEAM. RG3 IEC EN 62471-5:2015. CLASS 2 IEC EN 60825-1:2014. HAZARD DISTANCE: CONSULT SAFETY MANUAL.**

THIS PRODUCT IS IN CONFORMITY WITH PERFORMANCE STANDARDS FOR LASER PRODUCTS UNDER 21 CFR 1040, EXCEPT WITH RESPECT TO THOSE CHARACTERISTICS AUTHORIZED BY VARIANCE NUMBER 2016-V-0144 EFFECTIVE ON JUNE 07, 2017.

**警告! 嚴禁肉眼視線進入投影光域。眼睛請勿直接暴露在投影光域內。雷射光輻射 - 請勿凝視雷射光。RG3 IEC EN 62471-5 : 2015 CLASS 2 IEC EN 60825-1 : 2014. 危險距離:請參照安全手冊。**

**警告! 勿觀看投影机光束。眼睛勿直接接觸可允許暴露的光束。激光輻射-勿直視激光範圍內光束。RG3 IEC EN 62471-5 : 2015 CLASS 2 IEC EN 60825-1 : 2014. 危害距離:請參考安全手冊。**

**ATTENTION! NE PAS REGARDER LE FAISCEAU DU PROJECTEUR. EVITER TOUTE EXPOSITION DIRECTE DES YEUX AU FAISCEAU DU PROJECTEUR. RAYONNEMENT LASER - NE PAS REGARDER DANS LE FAISCEAU DU TELEMETRE. RG3 IEC EN 62471-5:2015. CLASS 2 IEC EN 60825-1:2014. DISTANCE DE SECURITE: CONSULTER LE MANUEL DE SECURITE.**



## 1.4 High Brightness precautions: Hazard Distance (HD)

### HD



Hazard Distance (HD) is the distance measured from the projection lens at which the intensity or the energy per surface unit becomes lower than the applicable exposure limit on the cornea or on the skin. The light beam is considered (to be) unsafe for exposure if the distance from a person to the light source is less than the HD.

### Restriction Zone (RZ) based on the HD

The HD depends on the amount of lumens produced by the projector and the type of lens installed. See chapter "HD in function of modifying optics", page 21.

To protect untrained end users (as cinema visitors, spectators) the installation shall comply with the following installation requirements: Operators shall control access to the beam within the hazard distance or install the product at the height that will prevent spectators' eyes from being in the hazard distance. Radiation levels in excess of the limits will not be permitted at any point less than 2.0 meter (SH) above any surface upon which persons other than operators, performers, or employees are permitted to stand or less than 1.0 meter (SW) lateral separation from any place where such persons are permitted to be. In environments where unrestrained behavior is reasonably foreseeable, the minimum separation height should be greater than or equal to 3.0 meter to prevent potential exposure, for example by an individual sitting on another individual's shoulders, within the HD.

These values are minimum values and are based on the guidance provided in IEC 62471-5:2015 section 6.6.3.5.

The installer and user must understand the risk and apply protective measures based upon the hazard distance as indicated on the label and in the user information. Installation method, separation height, barriers, detection system or other applicable control measure shall prevent hazardous eye access to the radiation within the hazard distance.

For example, projectors that have a HD greater than 1 m and emit light into an uncontrolled area where persons may be present should be positioned in accordance with "the fixed projector installation" parameters, resulting in a HD that does not extend into the audience area unless the beam is at least 2.0 meter above the floor level. In environments where unrestrained behavior is reasonably foreseeable, the minimum separation height should be greater than or equal to 3.0 meter to prevent potential exposure, for example by an individual sitting on another individual's shoulders, within the HD. Sufficiently large separation height may be achieved by mounting the image projector on the ceiling or through the use of physical barriers.

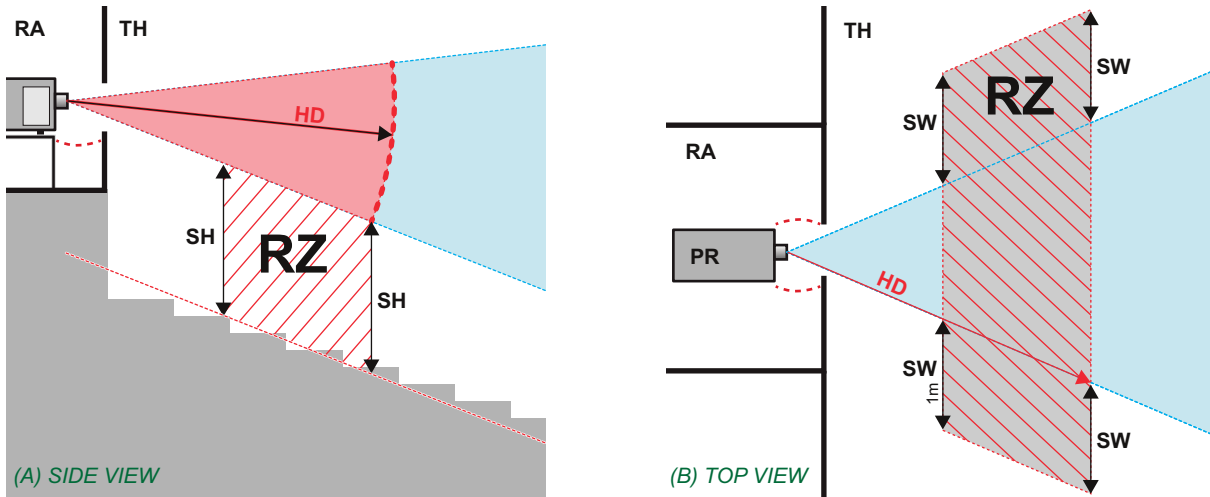

Image 1-2

- A** Side view.
- B** Top view.
- RA** Restricted Access location (boot area of projector).
- PR** Projector.
- TH** Theater.
- RZ** Restriction Zone in the theater.
- SH** Separation Height.
- SW** Separation Width.

Based on national requirements, no person is allowed to enter the projected beam within the zone between the projection lens and the related hazard distance (HD). This shall be physically impossible by creating sufficient separation height or by placing barriers. The minimum separation height takes into account the surface upon which persons other than operator, performers or employees are permitted to stand.

On Image 1-3 a typical setup is displayed. It must be verified if these minimum requirements are met. If required a restricted zone (RZ) in the theater must be established. This can be done by using physical barrier, like a red rope as illustrated in Image 1-3.

The restricted area sticker can be replaced by a sticker with only the symbol.

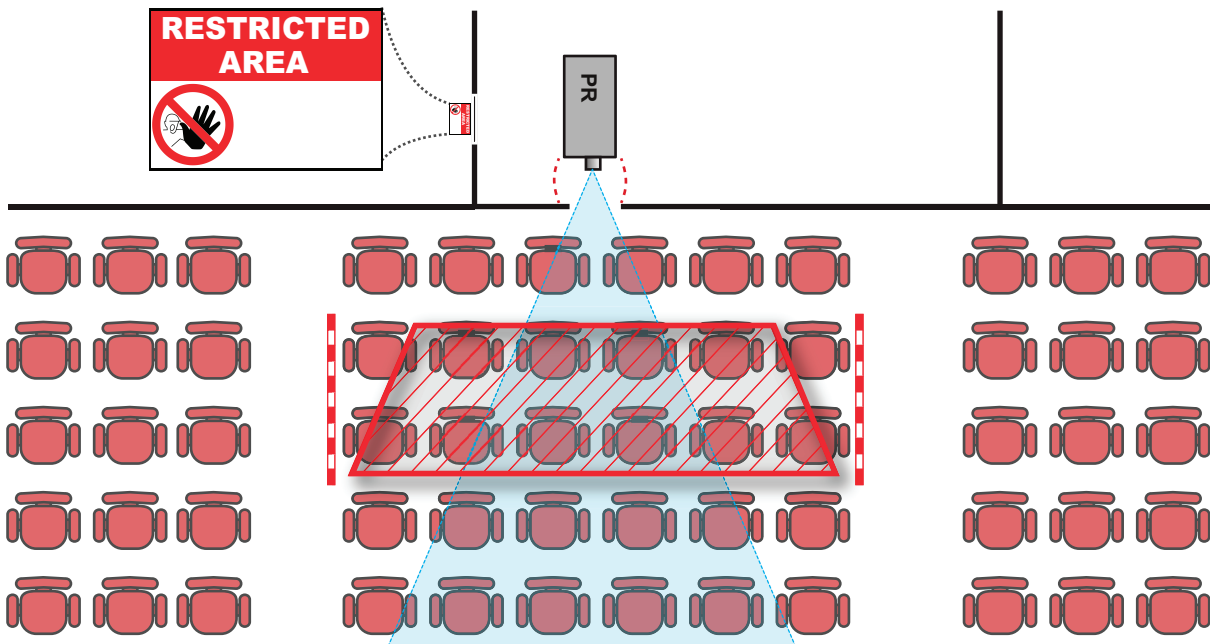

Image 1-3

**USA market (For FDA notice No 57)**

For LIPs (Laser Illuminated Projectors) installed in the USA market other restriction zone conditions apply.

LIPs for installation in restrained environment (cinema theaters) shall be installed at height vertically above the floor such that the bottom plane of the hazard distance zone shall be no lower than 2.5 meters above the floor. Horizontal clearance to the hazard distance zone shall be not less than 1 meter.

LIPs for installations in unrestrained environment (large venues,..) shall be installed at a height vertically above the floor such that the bottom plane of the Hazard distance Zone shall be no lower than 3 meters above the floor. Horizontal clearance to the hazard distance zone shall be not less than 2.5 meters. Any human access horizontally to the Hazard Zone, if applicable, shall be restricted by barriers. If human access is possible in an unsupervised environment, the horizontal or vertical clearances shall be increased to prevent exposure to the hazard distance zone.

In addition for temporary installations (e.g.: rental and staging, lease, events ...) the following requirements apply:

- This product can only be installed by Barco or sold or leased only to valid laser light show variance holders. In other words our installers are required to have an approved laser light show variance. Such installers may currently hold a valid variance for production of Class IIIb and IV laser light shows and/or for incorporation of the RG3 LIPs into their shows. Dealers and distributors are also required to obtain a valid laser light show variance.
- This product shall be located in such a way that all propagating beam paths within the Restriction Zone, and the audience can be directly observed at all times.
- Effects other than front or rear screen projections shall not be performed.
- Communication shall be maintained with other personnel assisting in surveillance of the LIP projection.
- In the event of any unsafe condition, immediately terminates (or designate the termination) of LIP projection light.

Install one or more readily accessible controls to immediately terminate LIP projection light. The power input at the projector side is considered as a reliable disconnect device. When required to switch off the projector, disconnect the power cord at the projector side. In case the power input at the projector side is not accessible (e.g. truss mount), the socket outlet supplying the projector shall be installed nearby the projector and be easily accessible, or a readily accessible general disconnect device shall be incorporated in the fixed wiring.

Laser light shows can be requested via the FDA online eSubmitter portal or via FDA Form FDA Form 3147 referencing to Barco's variance approval 2016-V-0144.

The installation checklist for laser illuminated RG3 projectors must be fully completed after the installation and sent to [pvg@barco.com](mailto:pvg@barco.com). This checklist can be downloaded from the Barco website. Only when the installer is a valid laser light show variance holder the checklist should not be sent to Barco.

## 1.5 HD for fully enclosed projection systems

### HD



Hazard Distance (HD) is the distance measured from the projection lens at which the intensity or the energy per surface unit becomes lower than the applicable exposure limit on the cornea or on the skin. The light beam is considered (to be) unsafe for exposure if the distance from a person to the light source is less than the HD.

### Restriction Zone (RZ) based on the HD

The projector is also suitable for rear projection applications; projecting a beam onto a diffuse coated projection screen. As displayed in Image 1-4 two areas should be considered: the restricted enclosed projection area (RA) and the observation area (TH).

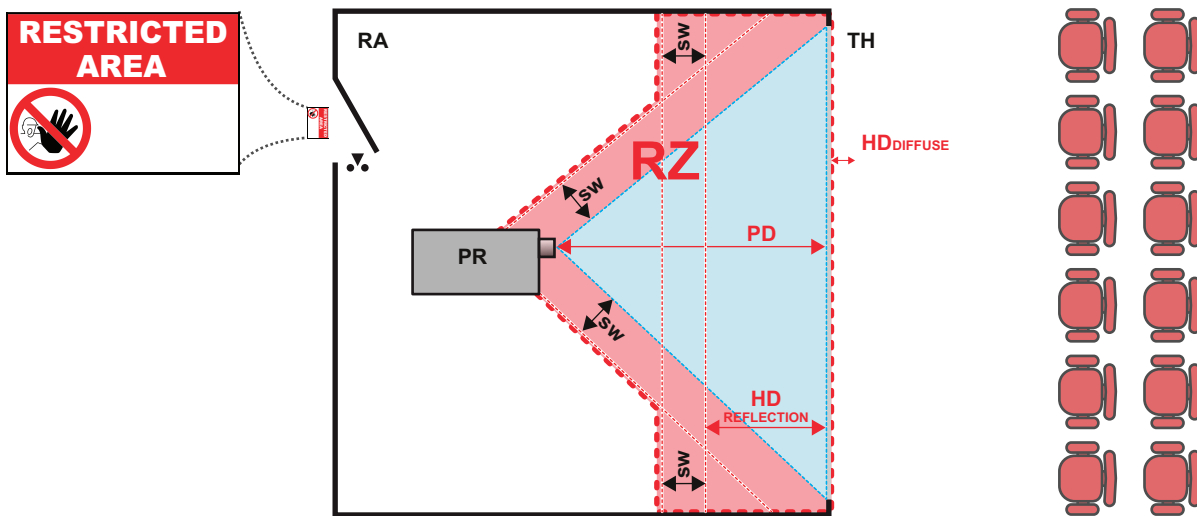

Image 1-4

**RA** Restricted Access location (enclosed projection area).

**PR** Projector.

**TH** Theater (observation area).

**RZ** Restriction Zone.

**PD** Projection Distance.

**SW** Separation Width. Must be minimum 1 meter.

For this type of setup 3 different HD shall be considered:

- HD as discussed in “High Brightness precautions: Hazard Distance (HD)”, page 17, relevant for intrabeam exposure.
- $HD_{\text{reflection}}$  : the distance that has to be kept restrictive related to the reflected light from the rear projection screen.
- $HD_{\text{diffuse}}$  : the relevant distance to be considered while observing the diffuse surface of the rear projection screen.

As described in “High Brightness precautions: Hazard Distance (HD)”, page 17, it is mandatory to create a restricted zone within the beam areas closer than any HD. In the enclosed projection area the combination of two restricted zones are relevant: The restricted zone of the projected beam toward the screen; taking into account 1 meter Separation Width (SW) from the beam onward. Combined with the restricted zone related to the rear reflection from the screen ( $HD_{\text{reflection}}$ ); also taking into account a 1 meter lateral separation.

The  $HD_{\text{reflection}}$  distance equals 25% of the difference between the determined HD distance and the projection distance to the rear projection screen. To determine the HD distance for the used lens and projector model see chapter “HD in function of modifying optics”, page 21.

$$HD_{\text{reflection}} = 25\% (HD - PD)$$

The light emitted from the screen within the observation shall never exceed the RG2 exposure limit, determined at 10 cm. The  $HD_{\text{diffuse}}$  can be neglected if the measured light at the screen surface is below 5000 cd/m<sup>2</sup> or 15000 LUX.

# 1.6 HD in function of modifying optics

## Hazard Distance

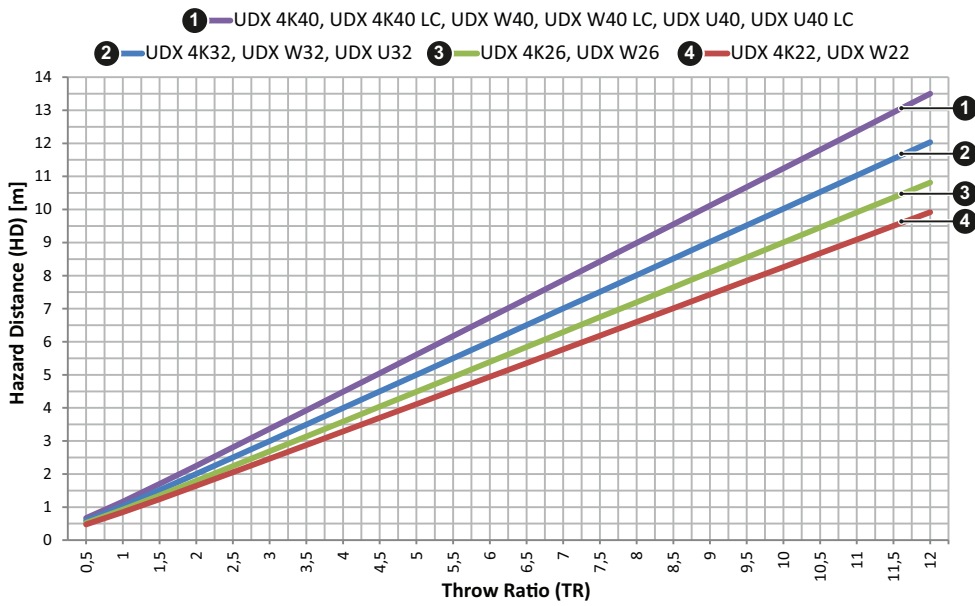

Image 1-5

**HD** Hazard Distance  
**TR** Throw Ratio



# Pulse Remote Control Unit

# 2

## Overview

- Remote control, battery installation
- Remote control, protocol setup
- Remote control, on/off button
- Functionality overview
- Functions of the “button pressed indicator”
- Function of the RGB filter button
- Displaying and Programming addresses into the RCU
- Using the XLR connector of the RCU
- Using the mini-jack connector of the RCU
- Silicone protection sleeve for the RCU (optional)

## 2.1 Remote control, battery installation

### Where to find the batteries for the remote control ?

The batteries are not placed in the remote control unit to avoid control operation in its package, resulting in a shorter battery life time. At delivery the batteries can be found in a separated bag attached to the remote control unit. Before using your remote control, install the batteries first.

### How to install

1. Push the battery cover tab with the fingernail a little backwards (1) and pull, at the same time, the cover upwards (2).

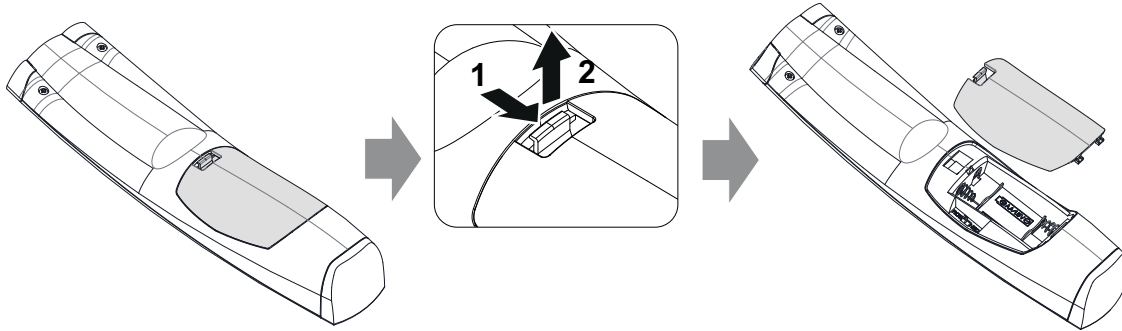

Image 2-1

2. Insert the two AA size batteries, making sure the polarities match the + and - marks inside the battery compartment.



*Tip:* Use alkaline batteries for optimum range and life time.

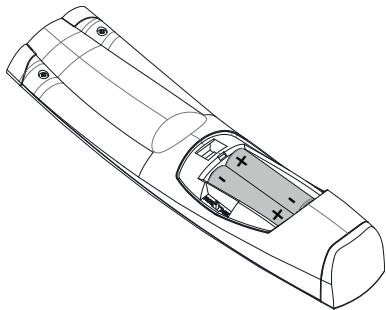

Image 2-2

3. Insert (1) both lower tabs of the battery cover in the gaps at the bottom of the remote control, and press (2) the cover until it clicks in place.

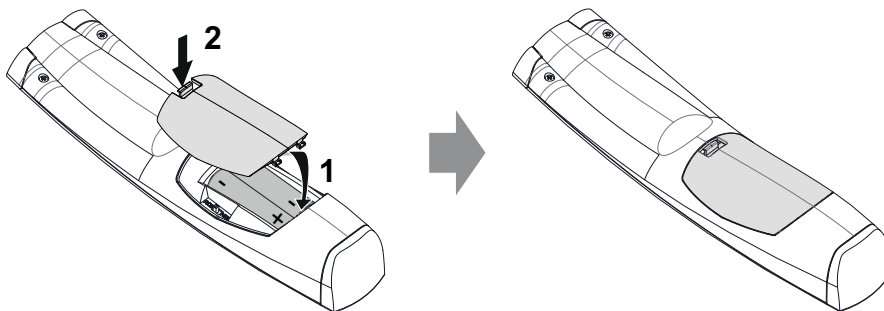

Image 2-3



When replacing batteries, the broadcast address of the RCU will be reset to its default value '0'.





**CAUTION:** Replace with the correct battery type. Use two AA size batteries. There is a risk of explosion if the battery is replaced with an incorrect type.



**CAUTION:** Replace the battery as explained above. There is a risk of explosion if the battery is incorrectly installed.

## 2.2 Remote control, protocol setup

### About the used protocol

The protocol is the code send out by the remote control when a button is pressed. Depending on this code, the projector can decode the signals. The remote control can be used with two different protocols: RC5 and NEC. Depending on the projector to control the remote control can be switched between these protocols.

### Which protocol to use

- The **NEC** protocol has to be used for Barco projectors based on the Pulse platform: F70, F80, F90, HDX 4K, UDX, XDL, etc.
- The **RC5** protocol has to be used all legacy Barco projectors: HDQ 2k40, HDF, HDX W, etc.

### How to set

1. Remove the cover. For more info on how to remove, see “Remote control, battery installation”, page 24.
2. Place the switch in the desired position.

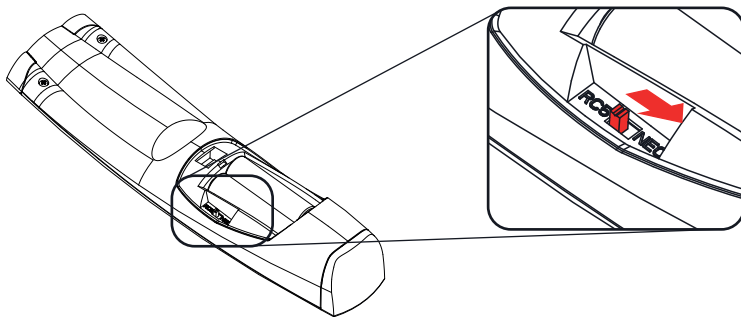

Image 2-4

### Remarks when using the RC5 protocol

Due to new or updated functionality not all buttons of the Pulse RCU are one-to-one compatible with the legacy Barco RCU and projectors. Take the following limitations into account:

- Buttons **Shutter open** and **Shutter close** emit the same code when in RC5 mode. This because the legacy RCU's only had 1 button for Shutter functionality.
- Buttons **Power on** and **Power off** emit the same code when in RC5 mode. This because the legacy RCU's only had 1 button for Power functionality.
- The **RGB filter** button is not supported.
- The **Input selection** button is not supported.
- The **Default value** button is not supported.
- The **Macro** button is not supported.

## 2.3 Remote control, on/off button

### Purpose of the remote control on/off button

The Pulse remote control unit has at the front side an on/off switch (reference 1 Image 2-5). Switching off the remote control prevents that unwanted commands are send due to an accidental key press. Furthermore, switching the RCU off will extend the battery life time of the remote control.

To activate the remote control press the on/off button.

To deactivate the remote control press the on/off button again.

Default when (re)placing batteries, is "ON".

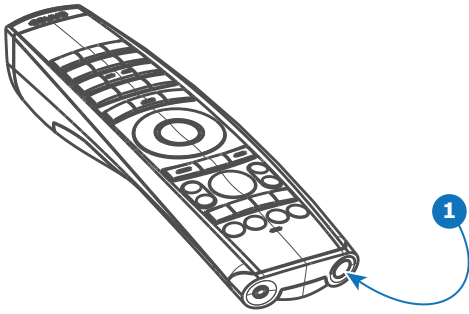

Image 2-5

## 2.4 Functionality overview

### Remote Control Unit buttons

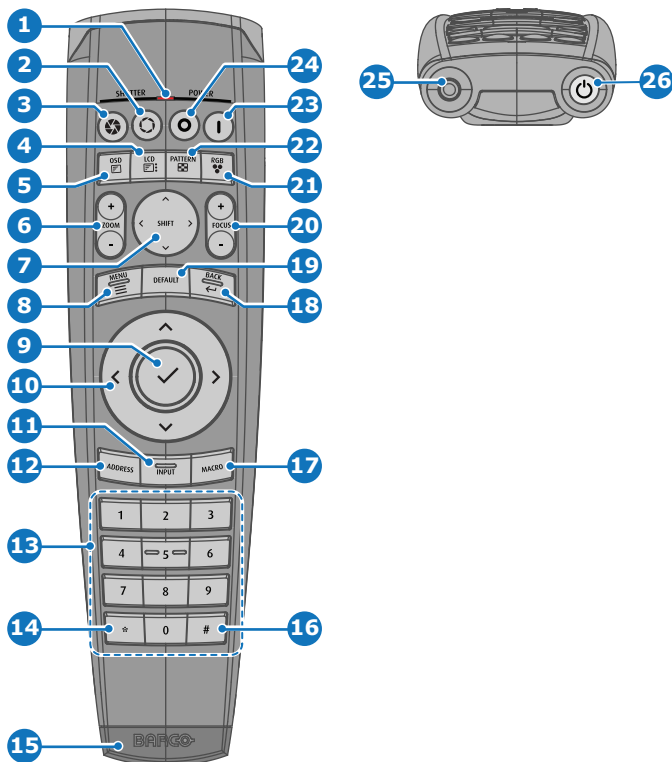

Image 2-6

- |                                    |  |
|------------------------------------|--|
| <b>1</b> Button pressed indicator  | <b>14</b> Backspace (while entering values)    |
| <b>2</b> Shutter open              | <b>15</b> XLR connector                        |
| <b>3</b> Shutter close             | <b>16</b> Decimal mark (while entering values) |
| <b>4</b> LCD panel on / off        | <b>17</b> Macro button                         |
| <b>5</b> Project OSD on / off      | <b>18</b> Menu back                            |
| <b>6</b> Lens zoom                 | <b>19</b> Default value button                 |
| <b>7</b> Lens shift                | <b>20</b> Lens focus                           |
| <b>8</b> Menu open / close         | <b>21</b> RGB filter                           |
| <b>9</b> Menu selection, OK button | <b>22</b> Test patterns                        |
| <b>10</b> Menu navigation          | <b>23</b> Power on                             |
| <b>11</b> Input selection          | <b>24</b> Power off                            |
| <b>12</b> Address button           | <b>25</b> 3.5 mm jack                          |
| <b>13</b> Numeric buttons          | <b>26</b> RCU on / off                         |

## 2.5 Functions of the “button pressed indicator”

### Functions button pressed indicator

- Rapidly flashes when commands are sent, this is the normal “button pressed” indication.
- 1 Short flash when remote control is switched ON by means of the on/off button.
- Continuously lit (up to 5 seconds) when address digits are expected after pressing the ADDR button.
- Slowly flashes (2 times a second) when the battery level is becoming low; typically when more than 85% of the useful life is past.

## 2.6 Function of the RGB filter button

### Filtering the color of the projected image

By pressing the RGB filter button on the RCU you can place a color filter on the output of the projector. This feature can be useful during the installation and configuration of a multi-projector or multi-channel setup. By having one projector project a red image and another project a green image, it is easier to spot and adjust the overlap section.

By pressing this button multiple times, you will have different active filters, in the following cycle:

- Red + Green + Blue (default)
- Red only
- Green only
- Blue only
- Red + Green
- Green + Blue
- Red + Blue
- Red + Green + Blue
- etc



After powering up, the colors will always revert back to full RGB.

## 2.7 Displaying and Programming addresses into the RCU

### Displaying the Projector Address on the Screen.

1. If the projector is on, press the menu key and navigate to the Status page. The projector address and the broadcast address can be seen under the Communication heading.

The projector's address is displayed on the LCD status screen and / or the OSD.

### How to Program an Address into the RCU?

1. Press the **Address** button until the *Button pressed indicator* lights up continuously (proximately 5 seconds).
2. Enter the address with the digit buttons within the time the indicator lights up (also proximately 5 seconds).

 **Note:** That address can be any value between 0 and 31.

*Tip:* A few examples:

To enter address 3, press "3" digit button on the RCU to set the RCU's address to 3 and wait until the *button pressed indicator* is out. Alternatively, you can also press "0" and "3". This way, the *button pressed indicator* goes out immediately.



To enter address 31, then press "3" and "1" on the digit button on the RCU and the *button pressed indicator* goes out immediately.

## 2.8 Using the XLR connector of the RCU



Connecting a cable with the XLR connector will reset the broadcast address of the RCU to its default value '0'.

### How to use the XLR connector

1. Remove the XLR cover by pulling it backwards.

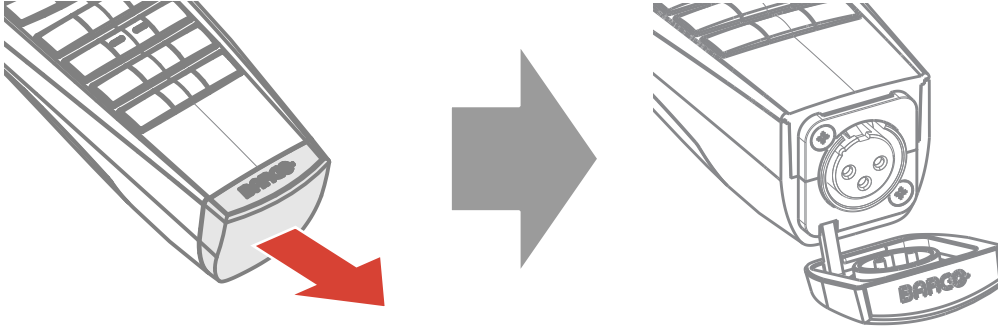

Image 2-7

2. Connect a cable with XLR plug into the XLR connector of the RCU.
3. Connect the other end of the cable with the XLR input of the projector.



*Note:* While the XLR cable is connected, the IR beam of the RCU is switched off.



## 2.9 Using the mini-jack connector of the RCU



Connecting a cable with the mini-jack connector will reset the broadcast address of the RCU to its default value '0'.

### How to use the mini-jack connector

1. Connect a cable with the mini-jack connector (reference 2 Image 2-8) of the RCU.
2. Connect the other end of the cable with the mini-jack input of the projector.

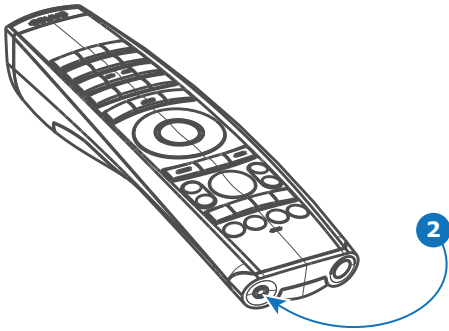

Image 2-8



**Note:** While the mini-jack cable is connected, the IR beam of the RCU is switched off.

## 2.10 Silicone protection sleeve for the RCU (optional)

### Introduction

Barco offers a silicone form fitting protection sleeve for the Pulse RCU. The silicone material keeps it comfortably, non slip and soft touch. All buttons and holes remain accessible. The sleeve is quick and easy installed. For ordering information see Barco website.

### How to install

1. Pull off the rubber XLR-lid from the RCU.



Image 2-9

2. Place back side (XLR side) of the RCU into the sleeve and pull the other side of the sleeve over the front side of the RCU.

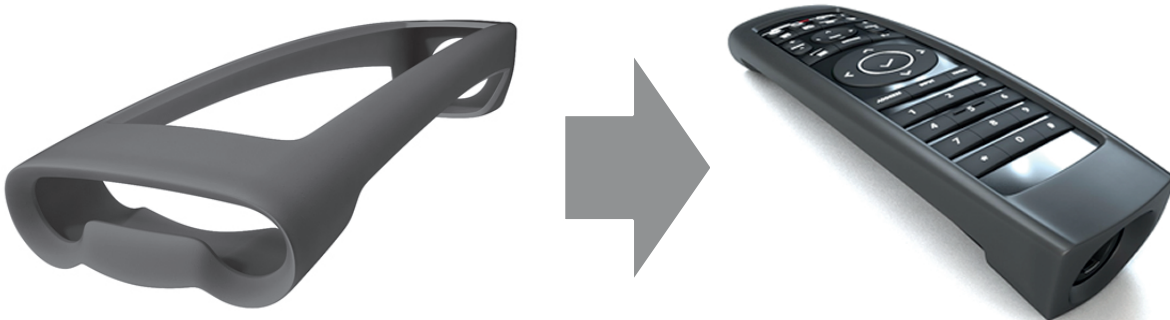

Image 2-10

# Input & Communication

# 3

## Overview

- Introduction
- Local Keypad and LCD panel
- Communication connections
- Input source connections – Quad combo input Mark II
- Input source connections – Quad combo input Mk I
- Input source connections – Quad DP 1.2 Input board
- Input source connections – SFP Input Board
- LED and Button indication chart
- Removal of an input board
- Installation of an input board or a communication board

## 3.1 Introduction

### General

The Input & Communication side of the projector consists of a local keypad (1), a communication panel (4) and a Quad Combo input board (5). The free input slot can be used for optional modules (e.g. the Quad DP 1.2 input board).

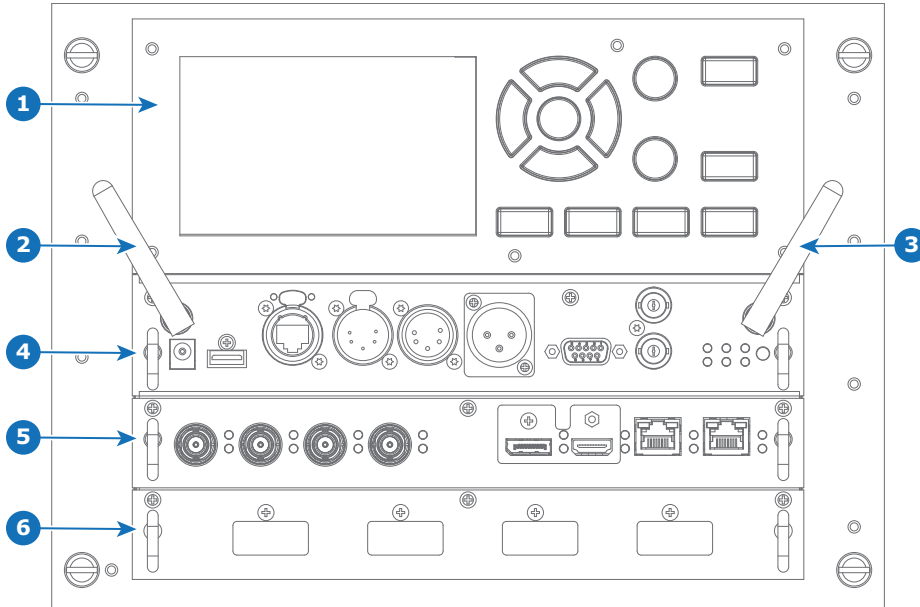

Image 3-1

- |   |   |
|---|---|
| <b>1</b> Local Keypad and LCD panel           | <b>4</b> Communication Panel  |
| <b>2</b> Optional antenna for WiFi connection | <b>5</b> Quad Combo Input board   |
| <b>3</b> Optional antenna for GSM             | <b>6</b> Free input slot (here filled with the Quad DP 1.2 Input board) |

## 3.2 Local Keypad and LCD panel

### Overview

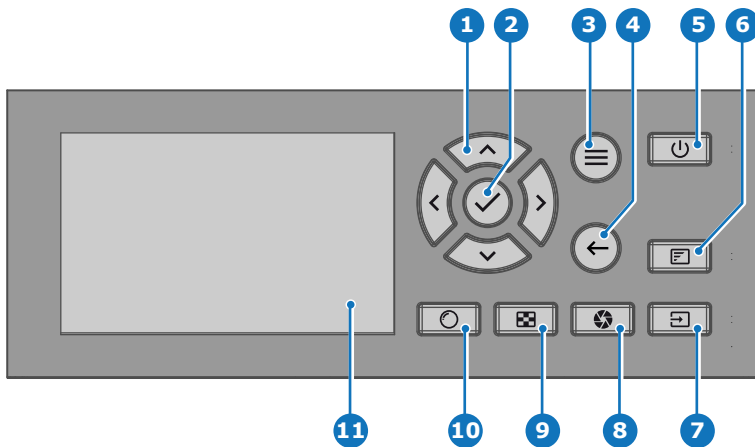

Image 3-2

- |                                       |                               |
|---------------------------------------|-------------------------------|
| <b>1</b> Menu navigation              | <b>7</b> Input selection      |
| <b>2</b> Menu confirmation, OK button | <b>8</b> Shutter open / close |
| <b>3</b> Menu open / close            | <b>9</b> Test patterns        |
| <b>4</b> Menu back                    | <b>10</b> Lens adjustment     |
| <b>5</b> Power on / off               | <b>11</b> LCD panel           |
| <b>6</b> Project OSD on / off         |                               |

### Local Keypad

The Keypad gives direct access to several functions, in addition to access to the menu system.

The keypad has a backlight that can be switched on and off manually. By default the light turns off after 5 minutes.

The Power button and Shutter buttons are equipped with white, blue and red backlit LEDs. The other keys are only equipped with white and blue backlit LEDs. The LEDs are controlled according to the features available.

### LCD panel

The LCD panel has two main functions:

1. Showing the menus, the adjustment information and also a mirror of the OSD, (On Screen Display) described in *User Interface* when this is enabled.
- Information regarding the status of the projector showing this data:
  - Projector status
  - Network address
  - Active source
  - Current firmware version
  - Operation Data
  - Active functions (Enabled Functions).

Toggle between the two indications by using the **Menu** button on the keypad, or on the remote control.

The LCD Display will fade out 30 seconds after the last key operation.

## 3.3 Communication connections

### Communication Panel

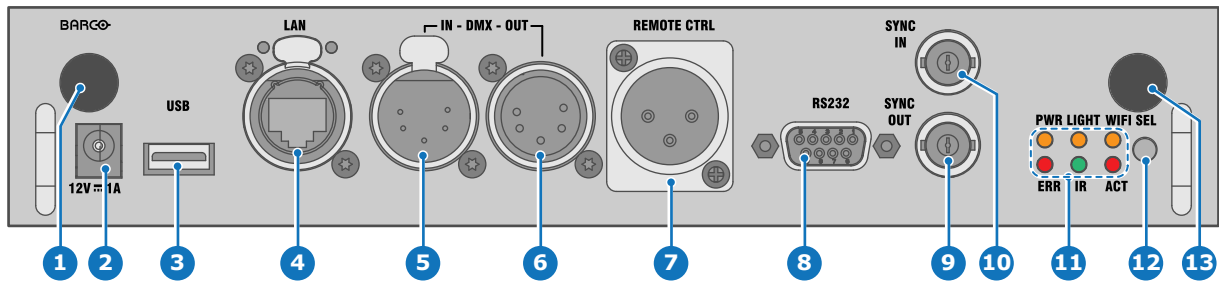

Image 3-3

- |   |  |    |                                |
|---|--|----|--------------------------------|
| 1 | WIFI antenna for wireless IP (optional)                | 8  | RS232 for serial communication |
| 2 | 12V 1A output  | 9  | Sync Out 3D                    |
| 3 | Firmware update / USB download log files               | 10 | Sync In 3D                     |
| 4 | 10/100 base-T for external control over IP and Art-Net | 11 | Status lights                  |
| 5 | DMX interface input                                    | 12 | IR receive sensor              |
| 6 | DMX interface output                                   | 13 | GSM antenna input (optional)   |
| 7 | XLR input for wired projector control                  |    |                                |

### 12 V output

12 V output, maximum 1 A, available when projector is not in stand by.

### DMX interface

DMX is used as communication bus between different devices in the light technic. Each device has an input and an output, so that the bus can be looped between the different devices. According the standard a five wire cable with XLR connector is used.

You can use the DMX input port to connect a DMX device (DMX console) to the projector. This way you can control the projector from that DMX device (console). The DMX output port can be connected with the next device in the loop.

Pin	Description
1	Earth
2	Cold
3	Hot
4	Return - (or not used)
5	Return + (or not used)



#### DMX

DMX-512 Lighting protocol over RS-485 interface. Carries information of 512 channels from a lighting controller to lighting devices. Standardized by USITT.

### RS232/RS422 input

The communication interface of the UDX series projector supports RS232 and RS422 serial communication on two different types of input connectors, a Sub-D connector and an USB connector acting as RS input when connected to an USB input of a PC.

You can use the RS232/RS422 input to connect a local PC to your UDX series projector. By this way you can configure and control your projector from your local PC.

Advantages of using RS232/RS422 serial communication:

- easy adjustment of the projector via PC (or MAC).
- allow storage of multiple projector configurations and set ups.
- wide range of control possibilities.
- address range from 0 to 255.
- sending data to the projector (update).
- copying data from the projector (backup).

### RS232/422 input (Sub-D) port

Pin	Description
1	DCD : Data Carrier Detect
2	RXD- : Receive Data
3	TXD- : Transmitted Data
4	DTR : Data Terminal Ready [RS232] TXD+ : Transmitted Data [RS422]
5	GND : Ground
6	DSR : Data Set Ready [RS232] RXD+ : Received Data [RS422]
7	— (not connected) —
8	CTS : Clear To Send
9	RI : Ring Indicator

#### RS232



An Electronic Industries Association (EIA) serial digital interface standard specifying the characteristics of the communication path between two devices using either D-SUB 9 pins or D-SUB 25 pins connectors. This standard is used for relatively short-range communications and does not specify balanced control lines. RS-232 is a serial control standard with a set number of conductors, data rate, word length and type of connector to be used. The standard specifies component connection standards with regard to computer interface. It is also called RS-232-C, which is the third version of the RS-232 standard, and is functionally identical to the CCITT V.24 standard. Logical '0' is  $> +3V$ , Logical '1' is  $< -3V$ . The range between  $-3V$  and  $+3V$  is the transition zone.

#### RS422



An EIA serial digital interface standard that specifies the electrical characteristics of balanced (differential) voltage, digital interface circuits. This standard is usable over longer distances than RS-232. This signal governs the asynchronous transmission of computer data at speeds of up to 920,000 bits per second. It is also used as the serial port standard for Macintosh computers. When the difference between the 2 lines is  $< -0.2V$  that equals with a logical '0'. When the difference is  $> +0.2V$  that equals to a logical '1'.

## USB port

The communication interface is equipped with a master USB port, type "A" connector. This USB port will simplify the service procedures for firmware updates or for downloading the log files without a network connection.

If the only file on the USB device is the firmware file (a "\*.fw" file), the projector will automatically start one of the following processes.

- **cornet<version nr>.fw**: The projector will upgrade or downgrade, depending on the version number.
- **LogExtractor.fw**: The log files will be downloaded.



Make sure that any used USB-stick is FAT32 compatible and contains no other files or folders.



## 3.4 Input source connections – Quad combo input Mark II

### About the Quad combo input Mark II

Due to demand from the market, Barco has created a second generation of the Input board to support 12G input and throughput on the SDI connectors. From the release of this board onward, the Quad combo input will be supported and will be the standard input board in every Input & Communication Unit, effectively replacing the Mark I variant.

The updates on this new board include the following compared to its predecessor:

- **SDI Input A** now also supports **12G** input signals.
- **SDI Input C** now also functions as a **loop-through output** for any signal placed on **Input A**.
- **SDI Input D** now also functions as a **loop-through output** for any signal placed on **Input B**.
- **HDBaseT Input 1** now also supports **network connectivity**.

### SDI Input & output – How does it work?

When connecting an SDI source to the projector and the signal is HD or 3G, you can choose any of the four input connectors.

When connecting multiple projectors with the same signal, you can connect the signal as follows:

- Connect the source signal to Input A or B of the first projector.
- If the source signal is connected to **Input A**, connect **Input/Output C** to the Input of the following projector.
- If the source signal is connected to **Input B**, connect **Input/Output D** to the Input of the following projector.
- Continue in the same fashion until all projectors are connected.

When connecting a 12G SDI source to the projector, you can only connect that source to input A.



Only Input A accepts 12G SDI signals . While it is technically possible to connect a 12G SDI source to Input B and connect that source to another projector in line (using Input/Output D), this first projector itself will not be able to process the 12G signal.

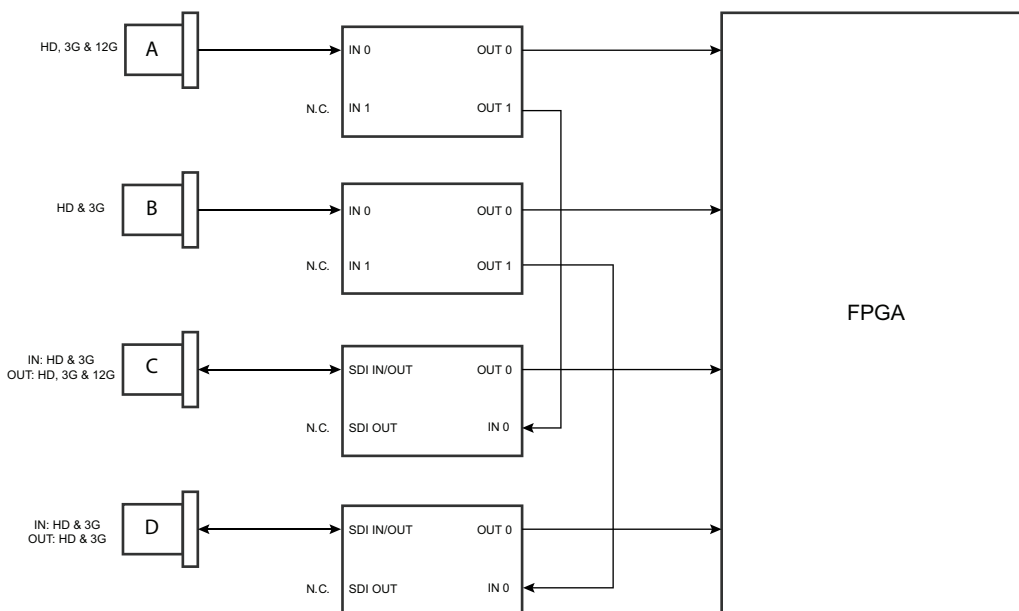

Image 3-4

### Spotting the difference between the Mark I and Mark II Input boards

Since there will be projectors in the field that have the Mark I Input Board and others that have the Mark II input board, it is important to know the difference between the two variants.

While there are several minor and barely noticeable differences between the two boards, there is one real visual aid to tell the two variants apart. There are visual markings added on the Mark II Input board, marking which connector supports 12G and which only supports 3G.

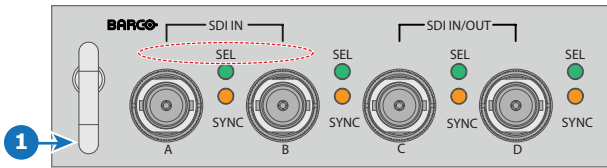

Image 3-5: Mark 1 Quad Combo input board, without markings above the SDI inputs

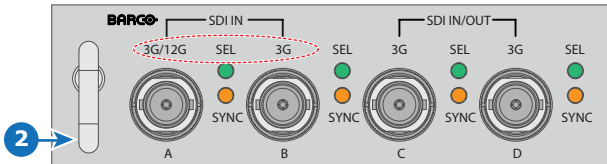

Image 3-6: Mark 2 Quad Combo input board, with 3G/12G markings above the SDI inputs/outputs.

### Overview Mark 2 Quad Combo Input board

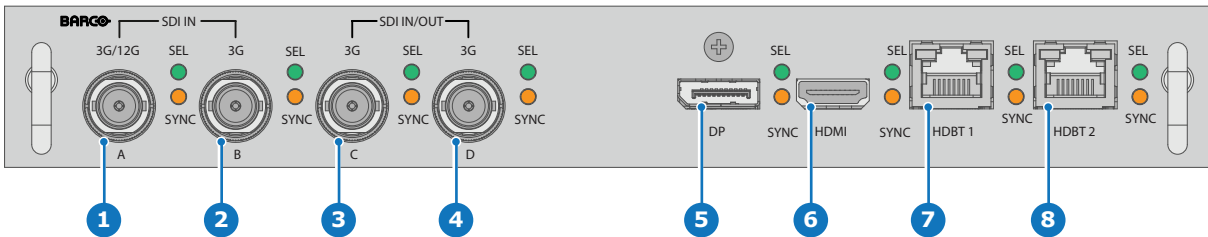

Image 3-7

- |   |   |
|---|---|
| <ul style="list-style-type: none"> <li>1 Quad SDI channel A: 3G/12G input</li> <li>2 Quad SDI channel B: 3G input</li> <li>3 Quad SDI channel C: 3G SDI input + 3G/12G output</li> <li>4 Quad SDI channel D: 3G SDI input / output</li> </ul> | <ul style="list-style-type: none"> <li>5 DisplayPort Input</li> <li>6 HDMI input</li> <li>7 HDBaseT input 1</li> <li>8 HDBaseT input 2</li> </ul> |
|---|---|



The yellow LED lights up when valid input sync is detected.  
 The green LED lights up when the input is selected.  
 The green LED lights blink when the input/output is selected and configured as output.

### Input specifications – SDI Inputs



For readability, the video timings listed are summarized. For the full list of video timings, refer to the appendices.



HD-SDI follows the SMPTE 292M standard  
 3G SDI follows the SMPTE 425M standard Level A  
 12G-SDI follows the SMPTE ST-2082-1 and ST-2082-10 standards.

<b>Color space</b>	YCbCr
<b>Color depth</b>	10 bpc
<b>Chroma sampling</b>	4:2:2
<b>Audio support</b>	not supported
<b>For future release</b>	<ul style="list-style-type: none"> <li>• 3D support</li> <li>• Interlaced support</li> </ul>

- Segmented frame support

Video timings progressive <sup>1</sup>	Type	Port type	Format
	HD-SDI	Single link Quad link	<ul style="list-style-type: none"> <li>• Up to 1920 x 1080 @24 Hz</li> <li>• Up to 1920 x 1080 @25 Hz</li> <li>• Up to 1920 x 1080 @30 Hz</li> <li>• Up to 1280 x 720 @50 Hz</li> <li>• Up to 1280 x 720 @60 Hz</li> </ul>
	3G-SDI "BarcoLink"	Single link Quad link	1920 x 1200 @50 Hz, @59.94 Hz and @60 Hz
	12G-SDI (Channel A only)	Single link	3840 x 2160 @50 Hz and @60 Hz 4096 x 2160 @50 Hz and @60 Hz
	12G-SDI "BarcoLink 4k" (Channel A only)	Single link	3840 x 2400 @50 Hz, @59.94 Hz and @60 Hz.

## Input specifications – HDMI Input



For readability, the video timings listed are summarized. For the full list of video timings, refer to the appendices.

<b>Pixel rate</b>	25 – 600 MHz pixel clock
<b>HDCP support</b>	<ul style="list-style-type: none"> <li>• HDCP 1.x</li> <li>• HDCP 2.2</li> <li>• RGB 4:4:4</li> </ul>
<b>Color space</b>	<ul style="list-style-type: none"> <li>• YCbCr 4:2:0</li> <li>• YCbCr 4:2:2</li> <li>• YCbCr 4:4:4</li> <li>• RGB 4:4:4</li> </ul>
<b>Color depth</b>	<ul style="list-style-type: none"> <li>• 24 bpp</li> <li>• 30 bpp</li> <li>• 36 bpp</li> </ul>
<b>3D support</b>	<ul style="list-style-type: none"> <li>• Field sequential 3D (Active 3D) <ul style="list-style-type: none"> <li>- Frame-packed</li> <li>- Top Bottom progressive</li> <li>- Side-by-side progressive</li> </ul> </li> <li>• Passive 3D <b>not</b> supported.</li> </ul>
<b>For future release</b>	<ul style="list-style-type: none"> <li>• Interlaced support</li> </ul>
<b>Audio</b>	Not supported
<b>Video timings<sup>1</sup></b>	<ul style="list-style-type: none"> <li>• Up to 4096 x 2160 @24 Hz</li> <li>• Up to 4096 x 2160 @25 Hz</li> <li>• Up to 4096 x 2160 @30 Hz</li> <li>• Up to 2048 x 1080 @48 Hz</li> <li>• Up to 4096 x 2160 @50 Hz</li> <li>• Up to 4096 x 2160 @60 Hz</li> </ul>
<b>Native video timings</b>	<ul style="list-style-type: none"> <li>• UDX-U-series: 1600 x 1200 @60 Hz</li> <li>• UDX-W-series: 1920 x 1200 @60 Hz</li> <li>• UDX-4k-series: 3840 x 2400 @60 Hz</li> </ul>

<sup>1</sup>: For the full list of video timings, see Appendix



**CAUTION:** The HDBaseT inputs can bridge a distance of 100 m but are sensitive to radiated electromagnetic interference: radiated electromagnetic interference (e.g. from GSM or switching inductive or capacitive loads) within the limits of electromagnetic compatibility requirements of 3 V/m can cause random flashes or temporary loss of the projected image. As such, shielded CAT-6 cables with metal RJ-45 connectors are recommended; choose cable length no longer than required and route HDBT cable optimally screened from possible sources of electromagnetic emission.

## Input specifications – HDBaseT inputs



For readability, the video timings listed are summarized. For the full list of video timings, refer to the appendices.

<b>Pixel rate</b>	25 – 297 MHz pixel clock	
<b>Color space</b>	<ul style="list-style-type: none"> <li>• YCbCr 4:2:2</li> <li>• YCbCr 4:4:4</li> <li>• RGB 4:4:4</li> </ul>	
<b>Color depth</b>	<ul style="list-style-type: none"> <li>• 24 bpp</li> <li>• 30 bpp</li> <li>• 36 bpp</li> </ul>	
<b>HDCP support</b>	HDCP 1.x supported on HDBaseT Input 1	
<b>Network support</b>	Yes, on HDBaseT Input 1	
<b>For future release</b>	<ul style="list-style-type: none"> <li>• 3D support</li> <li>• Interlaced support</li> </ul>	
<b>Audio</b>	not supported	
<b>Video timings progressive<sup>1</sup></b>	<b>Layout mode</b>	<b>Supported formats</b>
	Standard layout (1x1 layout)	<ul style="list-style-type: none"> <li>• Up to 4096 x 2160 @24 Hz</li> <li>• Up to 4096 x 2160 @25 Hz</li> <li>• Up to 4096 x 2160 @30 Hz</li> <li>• Up to 2048 x 1080 @48 Hz</li> <li>• Up to 2560 x 1600 @50 Hz</li> <li>• Up to 2560 x 1600 @60 Hz</li> </ul>
	2 Column mode (2x1 layout)	<ul style="list-style-type: none"> <li>• 1920 x 2160 @50 Hz</li> <li>• 1920 x 2160 @60 Hz</li> <li>• 2048 x 2160 @50 Hz</li> <li>• 2048 x 2400 @60 Hz</li> </ul>
<b>Native video timings</b>	<ul style="list-style-type: none"> <li>• UDX-U-series: 1600 x 1200 @60 Hz</li> <li>• UDX-W-series: 1920 x 1200 @60 Hz</li> <li>• UDX-4k-series: 3840 x 2160 @60 Hz</li> </ul>	



**CAUTION:** In order to display high resolution images (e.g.: 3840 x 2160 @60 Hz) via the DP1.2 input, the quality of the cable must be adequate, in addition the length of the cable can also influence the performance. In case there is an issue with one of these criteria the automatic link-training initiated by the DP-standard may decide to switch to a lower resolution.

## Input specifications – DisplayPort 1.2 input



For readability, the video timings listed are summarized. For the full list of video timings, refer to the appendices.

<b>Pixel rate</b>	Up to 600 MHz pixel clock
<b>Color space</b>	<ul style="list-style-type: none"> <li>• YCbCr 4:2:2</li> </ul>

	<ul style="list-style-type: none"> <li>• YCbCr 4:4:4</li> <li>• RGB 4:4:4</li> </ul>									
<b>Color depth</b>	<ul style="list-style-type: none"> <li>• 24 bpp</li> <li>• 30 bpp</li> <li>• 36 bpp</li> </ul>									
<b>Data rate support</b>	<ul style="list-style-type: none"> <li>• 1.62 Gbps: Reduced Bit Rate (RBR)</li> <li>• 2.7 Gbps: High Bit Rate (HBR)</li> <li>• 5.4 Gbps: High Bit Rate 2 (HBR2)</li> </ul>									
<b>HDCP support</b>	HDCP 1.4									
<b>For future release</b>	<ul style="list-style-type: none"> <li>• Interlaced support</li> </ul>									
<b>Audio</b>	not supported									
<b>3D support</b>	<ul style="list-style-type: none"> <li>• Field sequential 3D (Active 3D)</li> <li>• Passive 3D not supported on this board.</li> </ul>									
<b>Video timings progressive<sup>1</sup></b>	<table border="1"> <thead> <tr> <th>2D / 3D</th> <th>Layout Mode</th> <th>Supported formats</th> </tr> </thead> <tbody> <tr> <td>2D</td> <td>Standard layout (1x1 layout)</td> <td> <ul style="list-style-type: none"> <li>• Up to 4096 x 2160 @24 Hz</li> <li>• Up to 4096 x 2160 @30 Hz</li> <li>• Up to 2048 x 1080 @48 Hz</li> <li>• Up to 4096 x 2160 @50 Hz</li> <li>• Up to 4096 x 2160 @60 Hz</li> <li>• Up to 2560 x 1600 @120 Hz</li> </ul> </td> </tr> <tr> <td>Active 3D</td> <td>Standard layout (1x1 layout)</td> <td> <ul style="list-style-type: none"> <li>• 1600 x 1200 @120 Hz</li> <li>• 2560 x 1080 @120 Hz</li> <li>• 2560 x 1600 @120 Hz</li> </ul> </td> </tr> </tbody> </table>	2D / 3D	Layout Mode	Supported formats	2D	Standard layout (1x1 layout)	<ul style="list-style-type: none"> <li>• Up to 4096 x 2160 @24 Hz</li> <li>• Up to 4096 x 2160 @30 Hz</li> <li>• Up to 2048 x 1080 @48 Hz</li> <li>• Up to 4096 x 2160 @50 Hz</li> <li>• Up to 4096 x 2160 @60 Hz</li> <li>• Up to 2560 x 1600 @120 Hz</li> </ul>	Active 3D	Standard layout (1x1 layout)	<ul style="list-style-type: none"> <li>• 1600 x 1200 @120 Hz</li> <li>• 2560 x 1080 @120 Hz</li> <li>• 2560 x 1600 @120 Hz</li> </ul>
2D / 3D	Layout Mode	Supported formats								
2D	Standard layout (1x1 layout)	<ul style="list-style-type: none"> <li>• Up to 4096 x 2160 @24 Hz</li> <li>• Up to 4096 x 2160 @30 Hz</li> <li>• Up to 2048 x 1080 @48 Hz</li> <li>• Up to 4096 x 2160 @50 Hz</li> <li>• Up to 4096 x 2160 @60 Hz</li> <li>• Up to 2560 x 1600 @120 Hz</li> </ul>								
Active 3D	Standard layout (1x1 layout)	<ul style="list-style-type: none"> <li>• 1600 x 1200 @120 Hz</li> <li>• 2560 x 1080 @120 Hz</li> <li>• 2560 x 1600 @120 Hz</li> </ul>								
<b>Native video timings</b>	<ul style="list-style-type: none"> <li>• UDX-U-series: 1600 x 1200 @60 Hz</li> <li>• UDX-W-series: 1920 x 1200 @60 Hz</li> <li>• UDX-4k-series: 3840 x 2400 @60 Hz</li> </ul>									

## 3.5 Input source connections – Quad combo input Mk I

### Remark concerning the Mark 1 and Mark 2 boards

Due to mechanical and technical limitations of this input board, a new version of the Quad combo input board has been created (Mark 2, see also “Input source connections – Quad combo input Mark II”, page 41). Due to this, this board will miss functionality that has been implemented on the new board. These missing features include:

- **Loop-through** functionality
- **12G SDI** support
- Network connectivity on HDBaseT inputs

To upgrade your input board to the Mark 2 board, contact Barco.

### Overview Mark 1 Quad Combo Input board

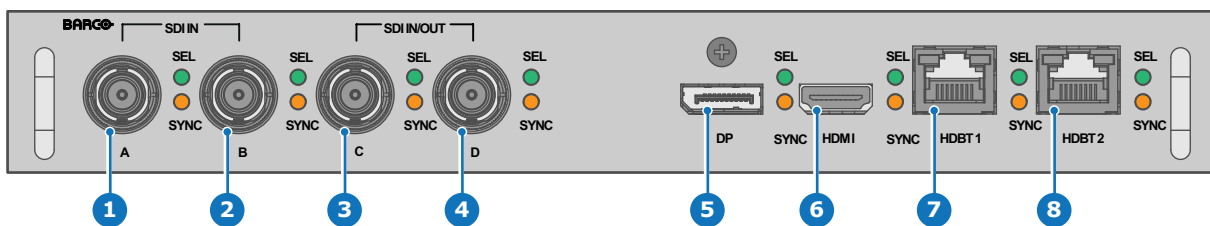

Image 3-8

- |                                       |                            |
|---------------------------------------|----------------------------|
| <b>1</b> Quad SDI channel A: 3G input | <b>5</b> DisplayPort Input |
| <b>2</b> Quad SDI channel B: 3G input | <b>6</b> HDMI input        |
| <b>3</b> Quad SDI channel C: 3G input | <b>7</b> HDBaseT input 1   |
| <b>4</b> Quad SDI channel D: 3G input | <b>8</b> HDBaseT input 2   |

The yellow LED lights up when valid input sync is detected.

The green LED lights up when the input is selected.

### Input specifications – SDI Inputs



For readability, the video timings listed are summarized. For the full list of video timings, refer to the appendices.



3G SDI follows the SMPTE 425M standard Level A  
HD-SDI follows the SMPTE 292M standard

<b>Color space</b>	YCbCr		
<b>Color depth</b>	10 bpc		
<b>Chroma sampling</b>	4:2:2		
<b>Not supported<sup>2</sup></b>	<ul style="list-style-type: none"> <li>• Audio support</li> <li>• 3D support</li> <li>• Interlaced support</li> <li>• Segmented frame support</li> <li>• Loop-through functionality</li> </ul>		
<b>Video timings progressive<sup>3</sup></b>	<b>Type</b>	<b>Port type</b>	<b>Format</b>
	HD-SDI	Single link Quad link	Up to 1920 x 1080 @24 Hz Up to 1920 x 1080 @25 Hz

2: The Mark II board has support for

3: For the full list of video timings, see Appendix

Up to 1920 x 1080 @30 Hz  
 Up to 1280 x 720 @50 Hz  
 Up to 1280 x 720 @60 Hz

3G-SDI Level A	Single link	Up to 2048 x 1080 @50 Hz
	Quad link	Up to 2048 x 1080 @60 Hz
3G-SDI "BarcoLink"	Single link	1920 x 1200 @50 Hz, @59.94 Hz and @60 Hz.
	Quad link	

## Input specifications – HDMI Input



For readability, the video timings listed are summarized. For the full list of video timings, refer to the appendices.

<b>Pixel rate</b>	25 – 600 MHz pixel clock
<b>HDCP support</b>	<ul style="list-style-type: none"> <li>• HDCP 1.x</li> <li>• HDCP 2.2</li> <li>• RGB 4:4:4</li> </ul>
<b>Color space</b>	<ul style="list-style-type: none"> <li>• YCbCr 4:2:0</li> <li>• YCbCr 4:2:2</li> <li>• YCbCr 4:4:4</li> <li>• RGB 4:4:4</li> </ul>
<b>Color depth</b>	<ul style="list-style-type: none"> <li>• 24 bpp</li> <li>• 30 bpp</li> <li>• 36 bpp</li> </ul>
<b>3D support</b>	<ul style="list-style-type: none"> <li>• Field sequential 3D (Active 3D)           <ul style="list-style-type: none"> <li>- Frame-packed</li> <li>- Top Bottom progressive</li> <li>- Side-by-side progressive</li> </ul> </li> <li>• Passive 3D <b>not</b> supported.</li> </ul>
<b>For future release</b>	<ul style="list-style-type: none"> <li>• Interlaced support</li> </ul>
<b>Audio</b>	not supported
<b>Video timings<sup>3</sup></b>	<ul style="list-style-type: none"> <li>• Up to 4096 x 2160 @24 Hz</li> <li>• Up to 4096 x 2160 @25 Hz</li> <li>• Up to 4096 x 2160 @30 Hz</li> <li>• Up to 2048 x 1080 @48 Hz</li> <li>• Up to 4096 x 2160 @50 Hz</li> <li>• Up to 4096 x 2160 @60 Hz</li> </ul>
<b>Native video timings</b>	<ul style="list-style-type: none"> <li>• UDX-U-series: 1600 x 1200 @60 Hz</li> <li>• UDX-W-series: 1920 x 1200 @60 Hz</li> <li>• UDX-4k-series: 3840 x 2400 @60 Hz</li> </ul>



**CAUTION:** The HDBaseT inputs can bridge a distance of 100 m but are sensitive to radiated electromagnetic interference: radiated electromagnetic interference (e.g. from GSM or switching inductive or capacitive loads) within the limits of electromagnetic compatibility requirements of 3 V/m can cause random flashes or temporary loss of the projected image. As such, shielded CAT-6 cables with metal RJ-45 connectors are recommended; choose cable length no longer than required and route HDBT cable optimally screened from possible sources of electromagnetic emission.

## Input specifications – HDBaseT inputs



For readability, the video timings listed are summarized. For the full list of video timings, refer to the appendices.

<b>Pixel rate</b>	25 – 297 MHz pixel clock	
<b>Color space</b>	<ul style="list-style-type: none"> <li>• YCbCr 4:2:2</li> <li>• YCbCr 4:4:4</li> <li>• RGB 4:4:4</li> </ul>	
<b>Color depth</b>	<ul style="list-style-type: none"> <li>• 24 bpp</li> <li>• 30 bpp</li> <li>• 36 bpp</li> </ul>	
<b>HDCP support</b>	HDCP 1.x supported on HDBaseT Input 1	
<b>Network support</b>	Yes, on HDBaseT Input 1	
<b>For future release</b>	<ul style="list-style-type: none"> <li>• 3D support</li> <li>• Interlaced support</li> </ul>	
<b>Audio</b>	not supported	
<b>Video timings progressive<sup>3</sup></b>	<b>Layout mode</b>	<b>Supported formats</b>
	Standard layout (1x1 layout)	<ul style="list-style-type: none"> <li>• Up to 4096 x 2160 @24 Hz</li> <li>• Up to 4096 x 2160 @25 Hz</li> <li>• Up to 4096 x 2160 @30 Hz</li> <li>• Up to 2048 x 1080 @48 Hz</li> <li>• Up to 2560 x 1600 @50 Hz</li> <li>• Up to 2560 x 1600 @60 Hz</li> </ul>
	2 Column mode (2x1 layout)	<ul style="list-style-type: none"> <li>• 1920 x 2160 @50 Hz</li> <li>• 1920 x 2160 @60 Hz</li> <li>• 2048 x 2160 @50 Hz</li> <li>• 2048 x 2400 @60 Hz</li> </ul>
<b>Native video timings</b>	<ul style="list-style-type: none"> <li>• UDX-U-series: 1600 x 1200 @60 Hz</li> <li>• UDX-W-series: 1920 x 1200 @60 Hz</li> <li>• UDX-4k-series: 3840 x 2160 @60 Hz</li> </ul>	



**CAUTION:** In order to display high resolution images (e.g.: 3840 x 2160 @60 Hz) via the DP1.2 input, the quality of the cable must be adequate, in addition the length of the cable can also influence the performance. In case there is an issue with one of these criteria the automatic link-training initiated by the DP-standard may decide to switch to a lower resolution.

## Input specifications – DisplayPort 1.2 input



For readability, the video timings listed are summarized. For the full list of video timings, refer to the appendices.

<b>Pixel rate</b>	Up to 600 MHz pixel clock
<b>Color space</b>	<ul style="list-style-type: none"> <li>• YCbCr 4:2:2</li> </ul>



	<ul style="list-style-type: none"> <li>• YCbCr 4:4:4</li> <li>• RGB 4:4:4</li> </ul>									
<b>Color depth</b>	<ul style="list-style-type: none"> <li>• 24 bpp</li> <li>• 30 bpp</li> <li>• 36 bpp</li> </ul>									
<b>Data rate support</b>	<ul style="list-style-type: none"> <li>• 1.62 Gbps: Reduced Bit Rate (RBR)</li> <li>• 2.7 Gbps: High Bit Rate (HBR)</li> <li>• 5.4 Gbps: High Bit Rate 2 (HBR2)</li> </ul>									
<b>HDCP support</b>	HDCP 1.4									
<b>For future release</b>	<ul style="list-style-type: none"> <li>• Interlaced support</li> </ul>									
<b>Audio</b>	not supported									
<b>3D support</b>	<ul style="list-style-type: none"> <li>• Field sequential 3D (Active 3D)</li> <li>• Passive 3D not supported on this board.</li> </ul>									
<b>Video timings progressive<sup>3</sup></b>	<table border="1"> <thead> <tr> <th>2D / 3D</th> <th>Layout Mode</th> <th>Supported formats</th> </tr> </thead> <tbody> <tr> <td>2D</td> <td>Standard layout (1x1 layout)</td> <td> <ul style="list-style-type: none"> <li>• Up to 4096 x 2160 @24 Hz</li> <li>• Up to 4096 x 2160 @30 Hz</li> <li>• Up to 2048 x 1080 @48 Hz</li> <li>• Up to 4096 x 2160 @50 Hz</li> <li>• Up to 4096 x 2160 @60 Hz</li> <li>• Up to 2560 x 1600 @120 Hz</li> </ul> </td> </tr> <tr> <td>Active 3D</td> <td>Standard layout (1x1 layout)</td> <td> <ul style="list-style-type: none"> <li>• 1600 x 1200 @120 Hz</li> <li>• 2560 x 1080 @120 Hz</li> <li>• 2560 x 1600 @120 Hz</li> </ul> </td> </tr> </tbody> </table>	2D / 3D	Layout Mode	Supported formats	2D	Standard layout (1x1 layout)	<ul style="list-style-type: none"> <li>• Up to 4096 x 2160 @24 Hz</li> <li>• Up to 4096 x 2160 @30 Hz</li> <li>• Up to 2048 x 1080 @48 Hz</li> <li>• Up to 4096 x 2160 @50 Hz</li> <li>• Up to 4096 x 2160 @60 Hz</li> <li>• Up to 2560 x 1600 @120 Hz</li> </ul>	Active 3D	Standard layout (1x1 layout)	<ul style="list-style-type: none"> <li>• 1600 x 1200 @120 Hz</li> <li>• 2560 x 1080 @120 Hz</li> <li>• 2560 x 1600 @120 Hz</li> </ul>
2D / 3D	Layout Mode	Supported formats								
2D	Standard layout (1x1 layout)	<ul style="list-style-type: none"> <li>• Up to 4096 x 2160 @24 Hz</li> <li>• Up to 4096 x 2160 @30 Hz</li> <li>• Up to 2048 x 1080 @48 Hz</li> <li>• Up to 4096 x 2160 @50 Hz</li> <li>• Up to 4096 x 2160 @60 Hz</li> <li>• Up to 2560 x 1600 @120 Hz</li> </ul>								
Active 3D	Standard layout (1x1 layout)	<ul style="list-style-type: none"> <li>• 1600 x 1200 @120 Hz</li> <li>• 2560 x 1080 @120 Hz</li> <li>• 2560 x 1600 @120 Hz</li> </ul>								
<b>Native video timings</b>	<ul style="list-style-type: none"> <li>• UDX-U-series: 1600 x 1200 @60 Hz</li> <li>• UDX-W-series: 1920 x 1200 @60 Hz</li> <li>• UDX-4k-series: 3840 x 2400 @60 Hz</li> </ul>									

## 3.6 Input source connections – Quad DP 1.2 Input board

### Quad DP 1.2 Input board

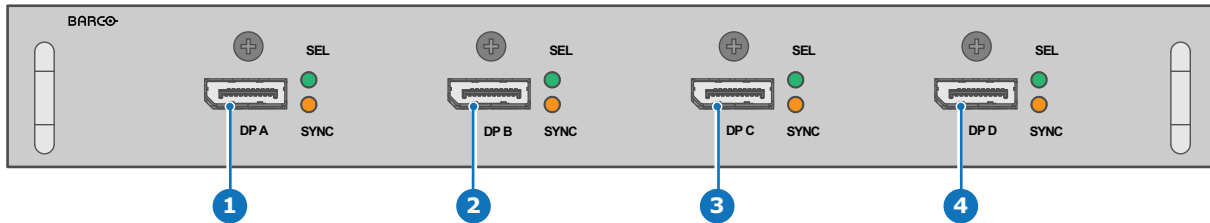

Image 3-9

- 1 Quad DisplayPort channel A input
- 2 Quad DisplayPort channel B input
- 3 Quad DisplayPort channel C input
- 4 Quad DisplayPort channel D input

The yellow LED lights up when valid input sync is detected.

The green LED lights up when the input is selected.

### Input specifications – DisplayPort 1.2 inputs



For readability, the video timings listed are summarized. For the full list of video timings, refer to the appendices.

<b>Pixel rate</b>	Up to 600 MHz pixel clock		
<b>Color space</b>	<ul style="list-style-type: none"> <li>• YCbCr 4:2:2</li> <li>• YCbCr 4:4:4</li> <li>• RGB 4:4:4</li> </ul>		
<b>Color depth</b>	<ul style="list-style-type: none"> <li>• 24 bpp</li> <li>• 30 bpp</li> <li>• 36 bpp</li> </ul>		
<b>Data rate support</b>	<ul style="list-style-type: none"> <li>• 1.62 Gbps: Reduced Bit Rate (RBR)</li> <li>• 2.7 Gbps: High Bit Rate (HBR)</li> <li>• 5.4 Gbps: High Bit Rate 2 (HBR2)</li> </ul>		
<b>For future release</b>	<ul style="list-style-type: none"> <li>• Interlaced support</li> <li>• HDCP 1.4</li> </ul>		
<b>Audio</b>	not supported		
<b>3D support</b>	<ul style="list-style-type: none"> <li>• Field sequential 3D (Active 3D)</li> <li>• Passive stereoscopic 3D (Passive stereo) converted to active 3D</li> </ul>		
<b>Video timings progressive<sup>4</sup></b>	<b>2D / 3D</b>	<b>Layout Mode</b>	<b>Supported formats</b>
	2D	Standard layout (1x1 layout)	<ul style="list-style-type: none"> <li>• Up to 4096 x 2160 @24 Hz</li> <li>• Up to 4096 x 2160 @30 Hz</li> <li>• Up to 2048 x 1080 @48 Hz</li> <li>• Up to 4096 x 2160 @50 Hz</li> <li>• Up to 4096 x 2160 @60 Hz</li> <li>• Up to 2560 x 1600 @120 Hz</li> </ul>

4: For the full list of video timings, see Appendix

2D	2 column mode (2x1 layout)	<ul style="list-style-type: none"> <li>• 1920 x 2160 @60 Hz</li> <li>• 1920 x 2160 @120 Hz</li> <li>• 1920 x 2400 @60 Hz</li> <li>• 2048 x 2160 @60 Hz</li> <li>• 2048 x 2160 @120 Hz</li> </ul>
2D	4 quadrant mode (2x2 layout)	<ul style="list-style-type: none"> <li>• 960 x 1080 @120 Hz</li> <li>• 960 x 1200 @120 Hz</li> <li>• 1280 x 1080 @60 Hz</li> <li>• 1280 x 1080 @120 Hz</li> <li>• 1280 x 1600 @60 Hz</li> <li>• 1280 x 1600 @120 Hz</li> <li>• 1920 x 1080 @120 Hz</li> <li>• 1920 x 1200 @120 Hz</li> <li>• 2048 x 1080 @120 Hz</li> </ul>
2D	4 column mode (4x1 layout)	<ul style="list-style-type: none"> <li>• 960 x 2160 @120 Hz</li> <li>• 960 x 2400 @120 Hz</li> <li>• 1024 x 2160 @60 Hz</li> </ul>
Active 3D	Standard layout (1x1 layout)	<ul style="list-style-type: none"> <li>• 1600 x 1200 @120 Hz</li> <li>• 2560 x 1080 @120 Hz</li> <li>• 2560 x 1600 @120 Hz</li> </ul>
Active 3D	2 column mode (2x1 layout)	1920 x 2160 @120 Hz
Active 3D	4 quadrant mode (2x2 layout)	<ul style="list-style-type: none"> <li>• 1920 x 1080 @120 Hz</li> <li>• 1920 x 1200 @120 Hz</li> <li>• 2048 x 1080 @120 Hz</li> </ul>
Active 3D	4 column mode (4x1 layout)	<ul style="list-style-type: none"> <li>• 960 x 2160 @120 Hz</li> <li>• 960 x 2400 @120 Hz</li> <li>• 1024 x 2160 @120 Hz</li> </ul>
Passive stereo	Standard layout (1x1 layout)	3840 x 2160 @60 Hz
Passive stereo	2 column mode (2x1 layout)	1920 x 2160 @60 Hz

**Native video timings**

- UDX-U-series: 1600 x 1200 @60 Hz
- UDX-W-series: 1920 x 1200 @60 Hz
- UDX-4k-series: 3840 x 2400 @60 Hz

## 3.7 Input source connections – SFP Input Board



The Barco SFP Input Board has been designed and tested to work alongside the Barco SFP Output Board.

However, it is possible that the SFP Input board can also work with other third-party devices that support 12G over fiber. Due to the many third-party options available on the market, the input board could not be tested for every option available.

### SFP input board

To connect 12G SDI over fiber.

The input board is delivered without any connector. It is up to the customer to buy the necessary connectors, transceivers and cables. These parts can be mounted on the indicated places on the front panel of the board.

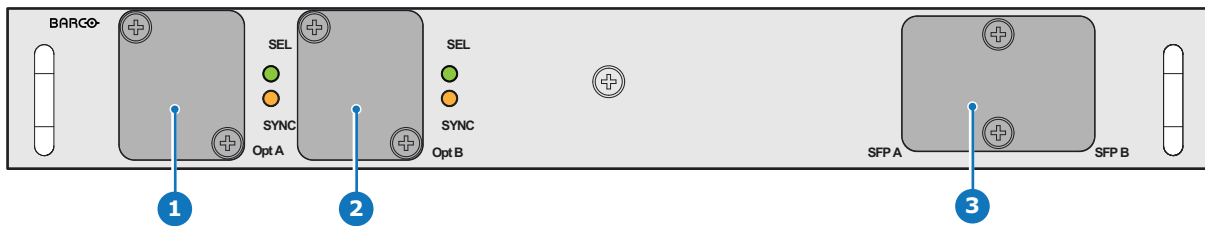

Image 3-10

- 1 Neutrik Duo optical connector or Neutrik Quad optical connector
- 2 Neutrik Duo optical connector or Neutrik Quad optical connector
- 3 2x12G SDI/10GE transceiver

### Input specifications



For readability, the video timings listed are summarized. For the full list of video timings, refer to the appendices.

<b>Color space</b>	YCbCr		
<b>Color depth</b>	10 bpc		
<b>Chroma sampling</b>	4:2:2		
<b>Audio support</b>	not supported		
<b>Video timings progressive<sup>5</sup></b>	<b>Type</b>	<b>Port type</b>	<b>Format</b>
	HD-SDI	Single link	<ul style="list-style-type: none"> <li>• Up to 1920 x 1080 @24 Hz</li> <li>• Up to 1920 x 1080 @25 Hz</li> <li>• Up to 1920 x 1080 @30 Hz</li> <li>• Up to 1280 x 720 @50 Hz</li> <li>• Up to 1280 x 720 @60 Hz</li> <li>• Up to 1280 x 720 @24 Hz</li> <li>• Up to 1280 x 720 @30 Hz</li> <li>• Up to 1280 x 720 @25 Hz</li> </ul>
	3G-SDI	Single link	1920 x 1080 @50 Hz and @60 Hz 1920 x 1200 @50 Hz, @59.94 Hz and @60 Hz. 2048 x 1080 @50 Hz and @60 Hz

5: For the full list of video timings, see Appendix

12G-SDI

Single link

3840 x 2160 @50 Hz and @60 Hz  
 4096 x 2160 @50 Hz and @60 Hz  
 3840 x 2400 @50 Hz, @59.94 and @60 Hz

### User case 1 : SFP+ transceiver + Fiber connection (integrated or separated)

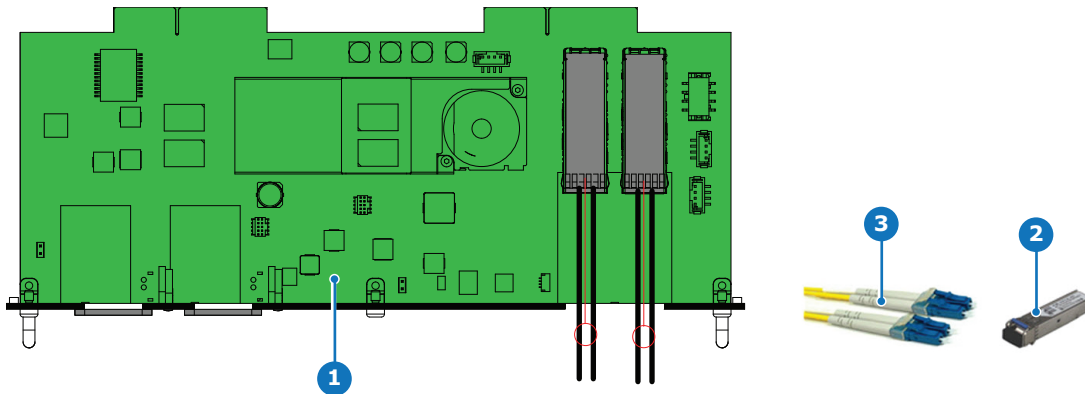

Image 3-11

- 1 SFP input board
- 2 SFP+ fiber transceiver
- 3 Optional breakout Optical adapter

Barco delivers only the Fiber-Network input board and SFP+ fiber transceivers.

The customer has to buy the SFP+ transceiver and the optional breakout adapter or the fiber integrated cable.

1. Remove the plate covering the access to the SFP cages.
2. Insert the SFP+ transceivers
3. Connect the breakout adapter.

### User case 2: Neutrik OpticalCon Duo + SFP+ transceiver + internal fiber

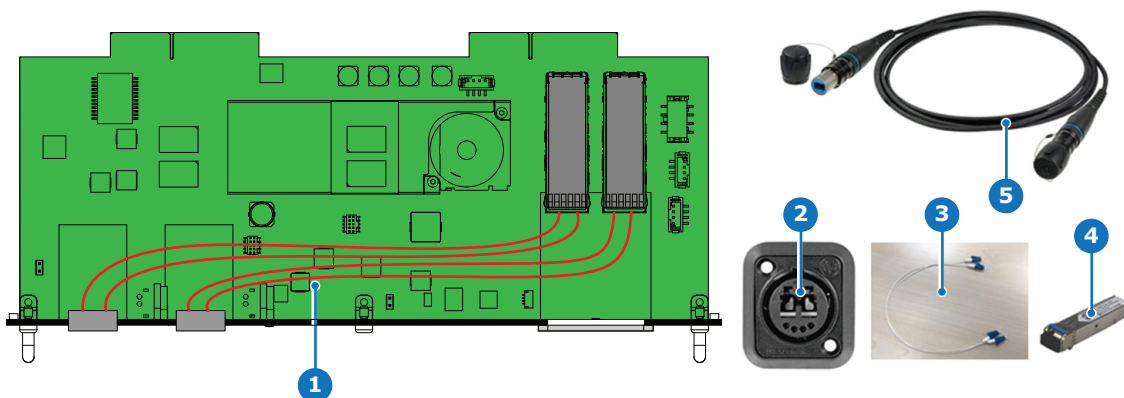

Image 3-12

- 1 SFP input board
- 2 Neutrik OpticalCon DUO
- 3 Internal fiber cable
- 4 SFP+ fiber transceiver
- 5 Cable

Barco delivers only the Fiber-Network input board and SFP+ fiber transceivers.

The customer has to buy the SFP+ transceiver, the Neutrik OpticalCon Duo, the internal cable and cable.

1. Remove both plates covering the access to the Neutrik connector locations.
2. Mount the Neutrik OpticalCon Duo connectors.
3. Remove the plate covering the access to the SFP cage and insert the SFP+ transceivers.  
Re-install the cover plate.

4. Mount the optical internal cables between the Neutrik connectors and the SFP+ transceivers.

### Use case 3: Neutrik OpticalCon Quad + SFP+ transceiver + internal fiber

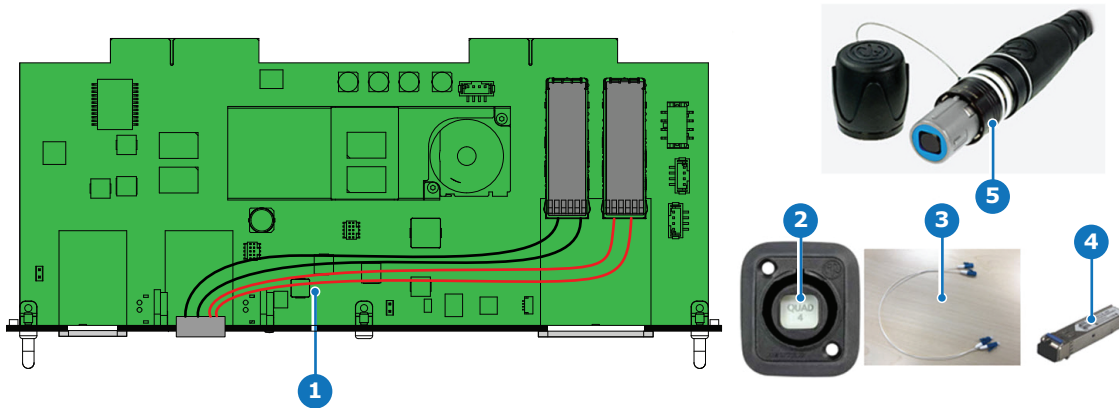

Image 3-13

- |                                  |                                 |
|----------------------------------|---------------------------------|
| <b>1</b> SFP input board         | <b>4</b> SFP+ fiber transceiver |
| <b>2</b> Neutrik OpticalCon Quad | <b>5</b> Advanced quad cable    |
| <b>3</b> Internal fiber cable    |                                 |

Barco delivers only the Fiber-Network input board and SFP+ fiber transceivers.

The customer has to buy the SFP+ transceiver, the Neutrik OpticalCon Quad, the internal cable and cable.

1. Remove one plate covering the access to a Neutrik connector location.
2. Mount the Neutrik OpticalCon Quad connector.
3. Remove the plate covering the access to the SFP cage and insert the SFP+ transceivers. Re-install the cover plate.
4. Mount the optical internal cables between the Neutrik connector and the SFP+ transceivers.

## Use case 4: Loop-through mode

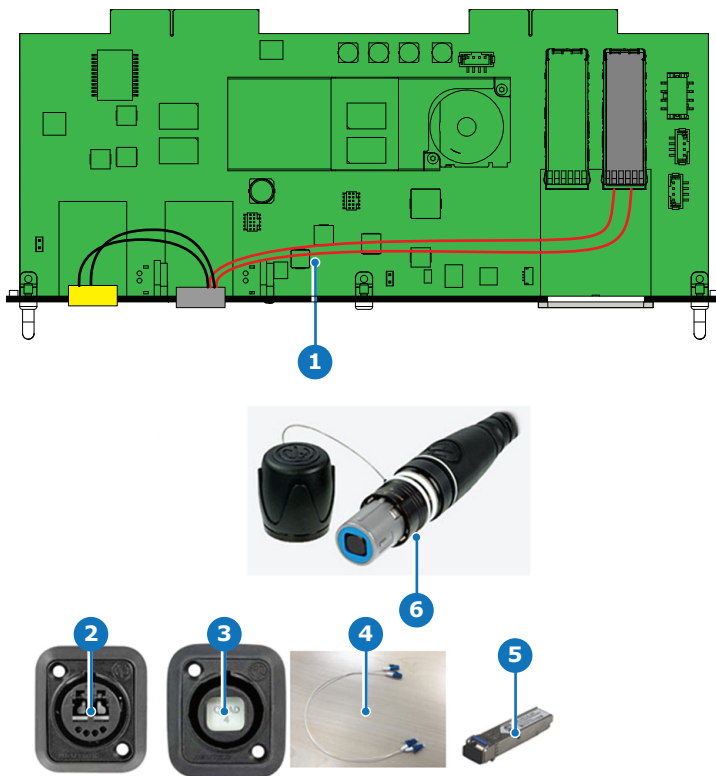

Image 3-14

- |                                  |                                 |
|----------------------------------|---------------------------------|
| <b>1</b> SFP input board         | <b>4</b> Internal fiber cable   |
| <b>2</b> Neutrik OpticalCon Duo  | <b>5</b> SFP+ fiber transceiver |
| <b>3</b> Neutrik OpticalCon Quad | <b>6</b> Advanced Quad cable    |



Barco delivers only the Fiber-Network input board and SFP+ fiber transceiver.

The customer has to buy the SFP+ transceivers, both Neutrik connectors, the internal cable and the cable.

1. Remove both plates covering the access to a Neutrik connector locations.
2. Mount the Neutrik OpticalCon Quad connector and the Neutrik OpticalCon Duo.
3. Remove the plate covering the access to the SFP cage and insert the SFP+ transceivers. Re-install the cover plate.
4. Mount the fiber internal cables between the Neutrik OpticalCon Quad and the SFP+ transceivers.
5. Mount the fiber internal cables between the Neutrik OpticalCon Quad and the Neutrik OpticalCon Duo.

## 3.8 LED and Button indication chart

### Button Backlight Status

Button	Color status	Description
<b>Standby button</b> 	Blinking WHITE (slow)	Projector starts up (booting)
	Blinking WHITE (fast)	Firmware upgrade
	Solid WHITE	Projector is in Standby mode
	Blinking BLUE	Projector goes to ON mode
	Solid BLUE	Projector is ON
	Blinking RED	Error condition
<b>Shutter button</b> 	Off (no color)	Projector is OFF, starts up, or is in Standby mode.
	Solid WHITE	Projector is ON, shutter is open
	Solid RED	Projector is ON, shutter is closed

### LED Status

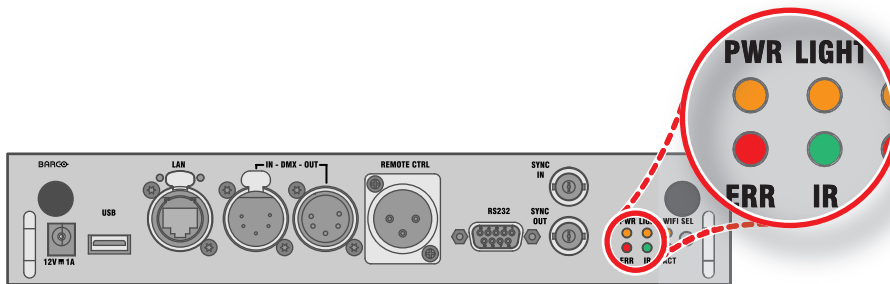

LED	Color status	Description
PWR (power LED)	Off	Projector powers up
	RED	Projector is in Standby
	ORANGE	Projector is Ready
	GREEN	Projector is on
LIGHT (Illumination LED)	Off	Light source is off
	RED	No light source detected
	ORANGE	Light source is on in ECO mode
	GREEN	Light source is on in normal mode
	GREEN-ORANGE	Light source is on in CLO mode
ERR (error LED)	Off	No error
	RED toggles on/off	Error
	ORANGE toggles on/off	Warning
IR	RED	IR signal received
	GREEN	IR signal acknowledged



## 3.9 Removal of an input board



**WARNING:** The procedures below may only be performed by Barco trained and qualified technicians.



**CAUTION:** Always wear a wrist band which is connected to the ground while handling the electrostatic discharge (ESD) sensitive parts.



The procedure below is applicable to all the input modules of the Input & Communication Unit of the projector.

### How to remove

1. Switch off the projector and unplug the power cord at the projector back side.
2. Release the 3 captive screws of the input module (4).

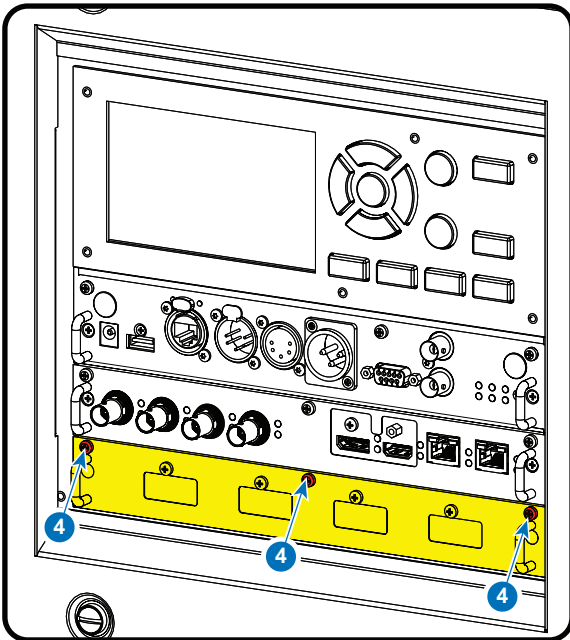

Image 3-15

3. Pull out the input module of the Input & Communication using the handles.

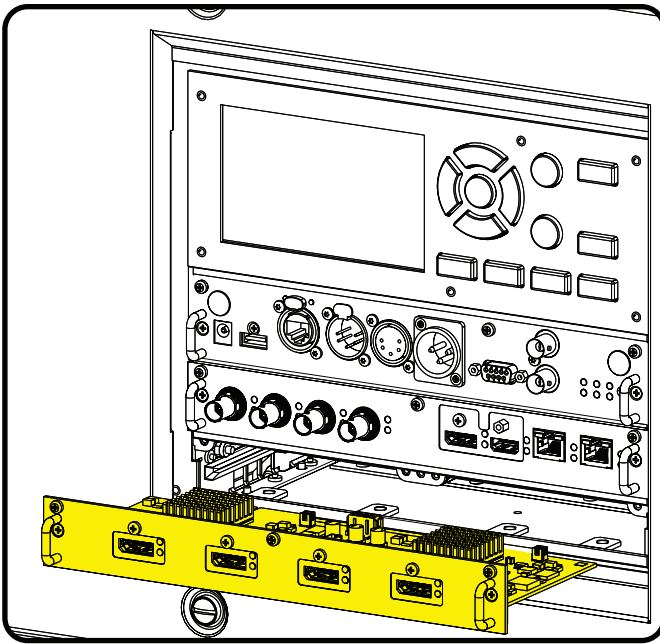

Image 3-16



**CAUTION:** Ensure that unused input slots of the Input & Communication Unit are always covered with a dummy front plate. After removing one of the input modules, immediately replace with an other one or install a dummy front plate on the unused input slot.

## 3.10 Installation of an input board or a communication board



**WARNING:** The procedures below may only be performed by Barco trained and qualified technicians.



**CAUTION:** Always wear a wrist band which is connected to the ground while handling the electrostatic discharge (ESD) sensitive parts.

### Required tools

Phillips screwdriver PH1



The procedure below is applicable to all the input modules of the Input & Communication Unit of the projector.

### How to install

1. Switch off the projector and unplug the power cord at the projector back side.
2. Push the input module in the Input & Communication Unit using the handles. Make sure the module seats in its sliders (2).

Pull in the module until the contacts (3) are fully inserted into the connectors.

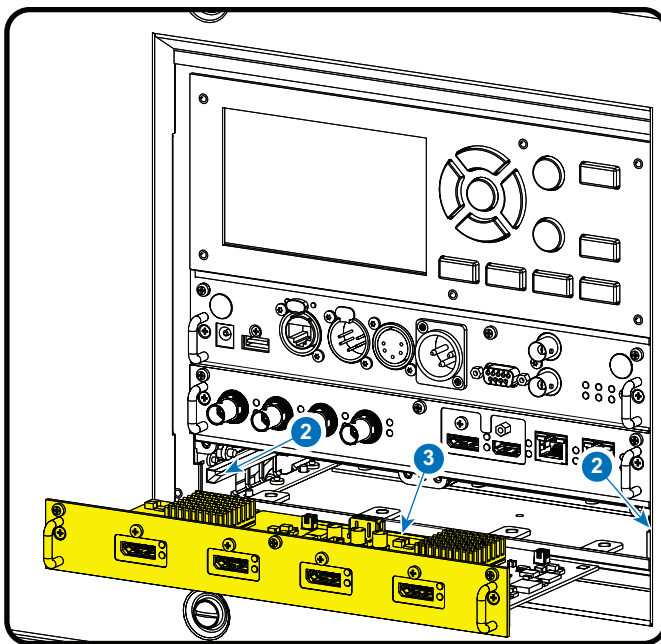

Image 3-17

3. Tighten the captive screws of the input module.

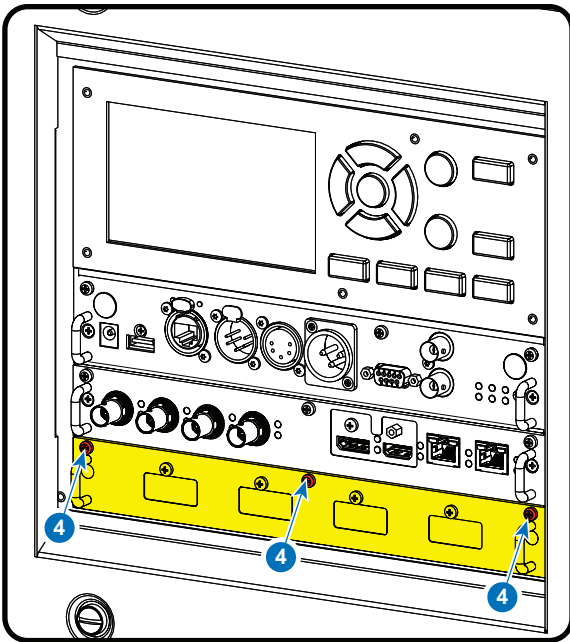

Image 3-18

4. Plug in the power cord at the projector back side.
5. **IMPORTANT LAST STEP** — Update the firmware of the installed module. Use the complete software package to install the firmware via Projector Toolset or USB stick.



*Tip:* When a complete new software image is placed on the projector, all programmable components will be updated with the latest version.

# Getting Started

# 4

## How to control the projector ?

The projector can be controlled by the local keypad, by the remote control unit or by browser application.

## Location of the local keypad ?

The local keypad is located on the input side of the projector.

## Remote control functions.

This remote control includes a battery powered infrared (IR) transmitter that allows the user to control the projector remotely. This remote control is used for source selection, control, adaptation and set up.

Other functions of the remote control are :

- switching between stand by and operational mode.
- switching to "pause" (blanked picture, full power for immediate restarting)
- direct access to all connected sources.

## Overview

- Power on projector
- Switching to standby
- Power off projector
- Using the RCU
- Projector Address
- Quick setup via Direct access
- Software update

## 4.1 Power on projector

### How to power on

1. Press the mains switch at the side of the projector to switch on this projector.

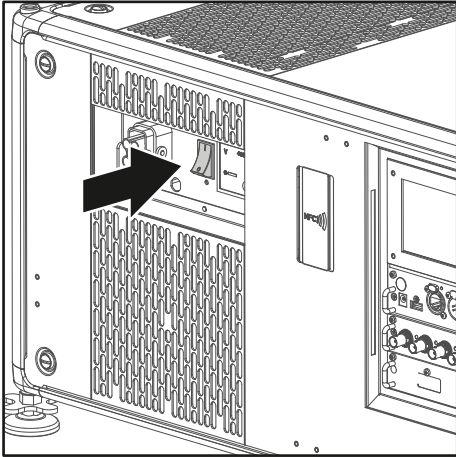

Image 4-1: Mains switch

- When '0' is pressed, the projector is switched off.
- When 'I' is pressed, the projector is switched on.

The projector starts up to standby mode. The **Power on/off** button will blink until standby mode is achieved. Once in standby mode, the Power on/off button will be lit WHITE, but the display will be off.

2. Press the **Power on/off** button on the projector, or the **Power On** button on the remote control.

The projector will continue to power on mode. The **Power on/off** button will blink until the projector is ready. Once the projector is ready, the Power button will be lit BLUE.

The start up screen is displayed on the touch panel and when fully started up, it changes to the overview screen.

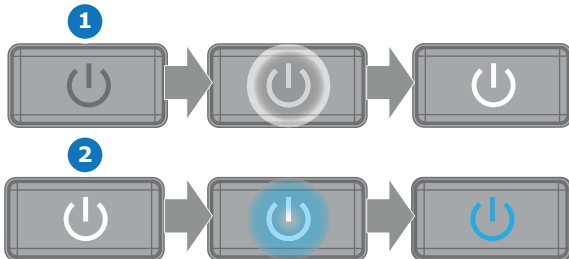

Image 4-2



The current mains input voltage is indicated on the voltmeter just above the power switch.



The background image of the startup screen and info screens can be changed with Projector Toolset with an installed UDX plug-in.

### Status overview

Once the projector is started, press **Status** to get an overview of parameters such as :

- Device serial number and article number
- Current firmware version and model name
- Current illumination (in percentage)
- Projector runtime in hours
- Uptime in hours

- Chosen source
- Current resolution and refresh rate
- Chosen communication method and IP address (if connected)
- Active functions

## Starting image projection

1. Make sure the available sources are connected to the appropriate input ports.

 *Tip:* If properly connected, the “SYNC” LED will light up ORANGE.

2. Press the **Input Selection** button on the keypad or on the remote control until:
  - the LED of the selected source (the “SEL” LED) lit up GREEN, and
  - the image of the selected source is projected.

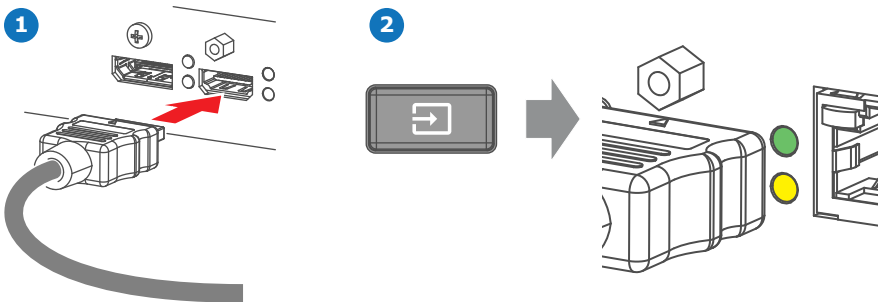

Image 4-3

## 4.2 Switching to standby

### How to switch to standby

1. Press and hold the **Power on/off** button for 3 seconds on the local keypad, or press the **Power Off** button on the remote control.

The projector goes to standby mode. The after-cooling cycle will start (about 30 seconds). During this period the Power on/off button will blink. Once the after-cooling cycle has ended, the projector will be in standby mode and the Power on/off button will be lit WHITE.

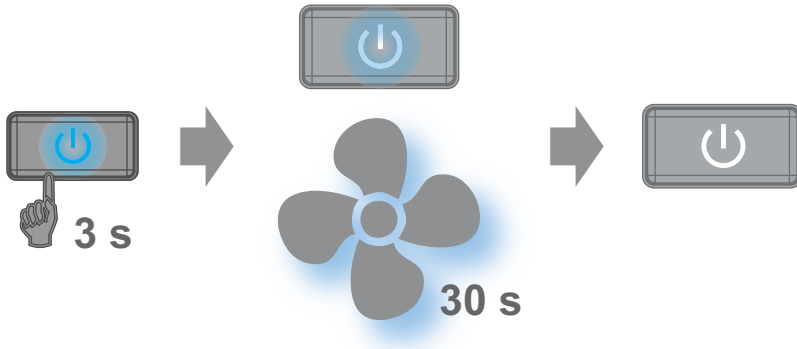

Image 4-4



## 4.3 Power off projector



**CAUTION:** This procedure assumes the projector is in **standby** mode.

### How to power off

1. Switch off the projector with the mains switch. '0' must be pressed.

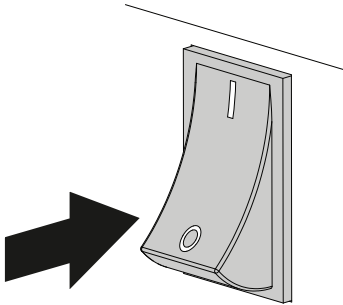

Image 4-5

2. Unplug the power cord from the projector.

## 4.4 Using the RCU

### Pointing to the reflective screen

1. Point the front of the RCU to the reflective screen surface.

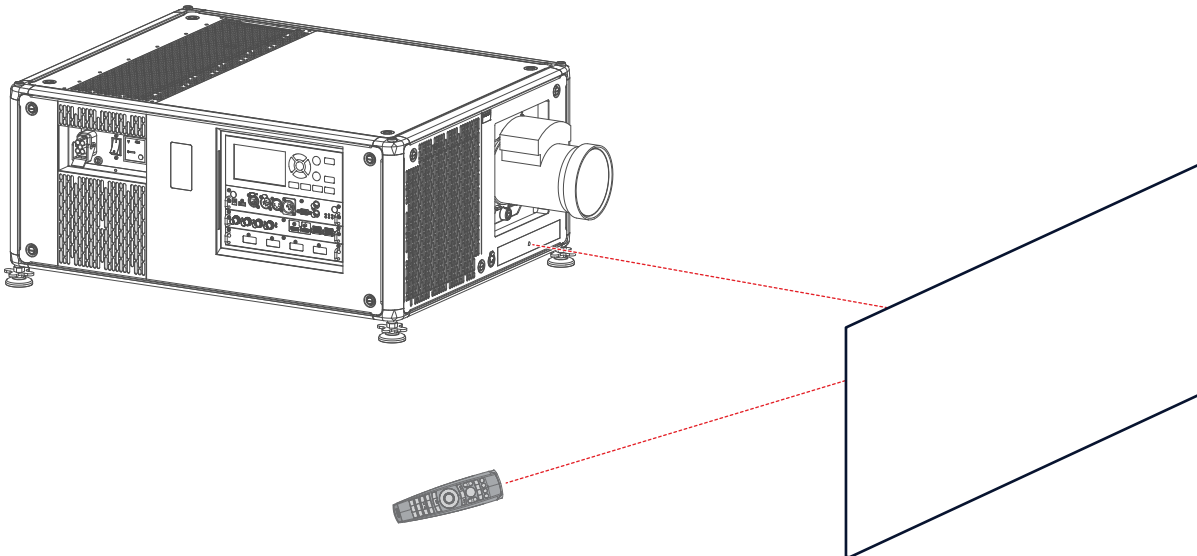

Image 4-6: IR control via reflective screen

### Hardwired to the XLR input

1. Plug one end of the remote cable in the connector on the bottom of the RCU.
2. Plug the other end in the big connector on the communication interface of the projector, labelled 'Remote CTRL'.



*Note:* Plugging the remote control will switch the broadcast address of the remote control to the default value '0'. This is the only broadcast address that will work when hardwired. If you want to change the broadcast address after disconnecting the remote control, see "Projector Address", page 68.

### Pointing directly to the IR sensor

When using the wireless remote control, make sure you are within the effective operating distance (30 m, 100 ft in a straight line). The remote control unit will not function properly if strong light strikes the sensor window or if there are obstacles between the remote control unit and the projector IR sensor.

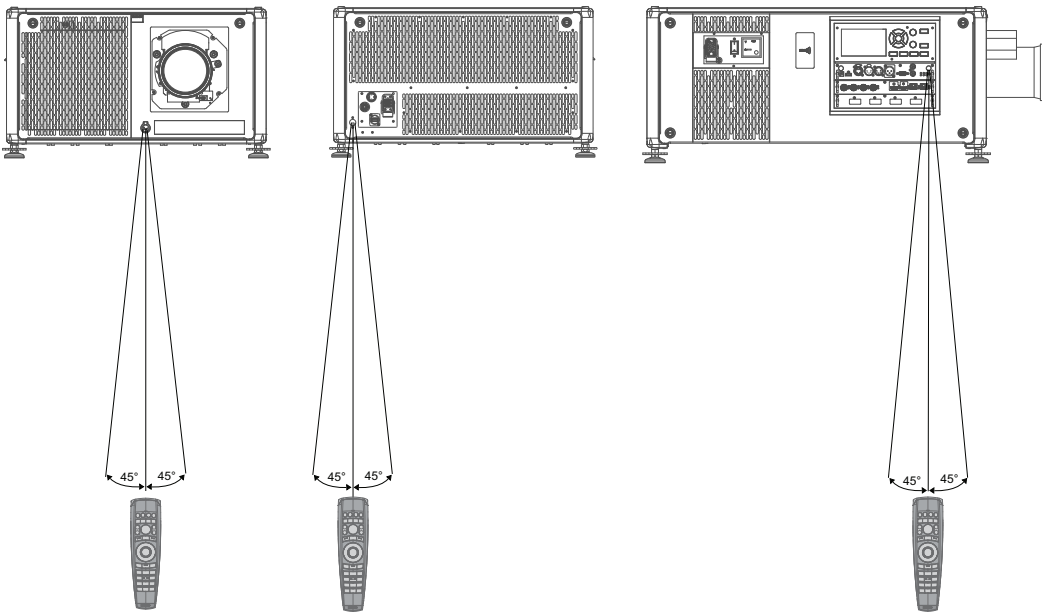

Image 4-7: RCU to one of the IR sensors

### Using the RCU in combination with a 3D emitter

When using a 3D emitter that radiates IR beams (e.g. the optional 3D emitter that Barco provides), the IR beams of the 3D emitter may interfere with the IR communication between projector and the RCU.

If such interference occurs, connect the RCU to the projector using the remote cable with XLR connector. It is also advised to turn the IR receivers of the projector off to avoid the 3D emitter interference. The IR receivers can be turned off in the GUI: *System Settings* → *Communication* → *IR Control*.

## 4.5 Projector Address



### **Projector address**

Address installed in the projector to be individually controlled.



### **Broadcast address**

Projector will always execute the command coming from a RCU programmed with that broadcast address.

## 4.5.1 Controlling the projector

### Why a projector address?

As more than one projector can be installed in a room, each projector should be separately addressable with an RCU or computer. Therefore each projector has its own address.

### Set up an individual Projector Address

The set up of a projector address can be done via the software.

### Projector controlling

When the address is set, the projector can be controlled now:

- with the RCU: only for addresses between 1 and 31.

### Broadcast Address

Every projector has a broadcast (common) address '0' or '1'. The default address is '0'.

The choice between '0' and '1' can be selected in the GUI: “*System Settings*” → “*Communication*” → “*IR Control*”



Placing new batteries in the remote control or plugging the remote to a projector via a cable will automatically reset the address back to its default value '0'.

## 4.6 Quick setup via Direct access

### Quick source selection

1. Press the **Input** button on the remote control or local keypad.

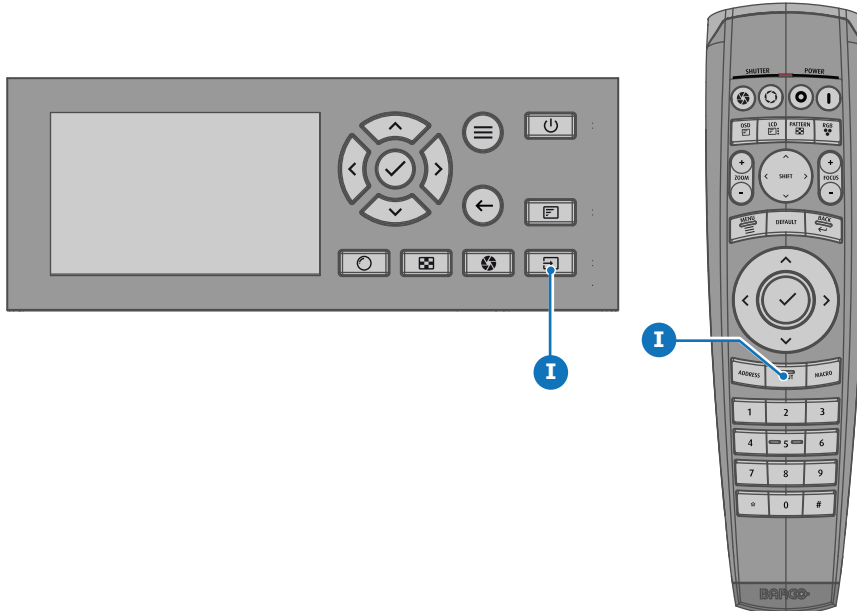

Image 4-8

The *Source selection* menu opens on the LCD display.

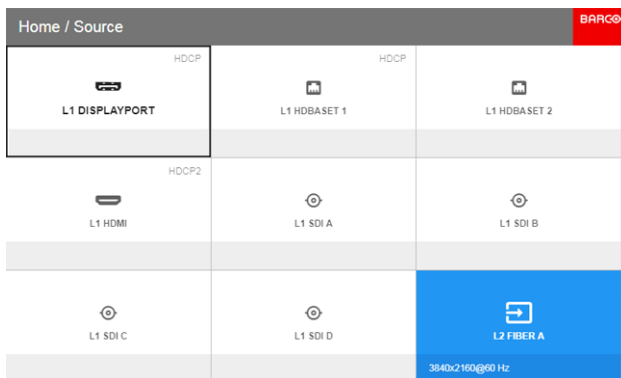

Image 4-9: Input selection

2. Use the arrow keys to select the desired source.

### Quick test pattern selection

1. Press the Test pattern button on the remote control or local keypad.

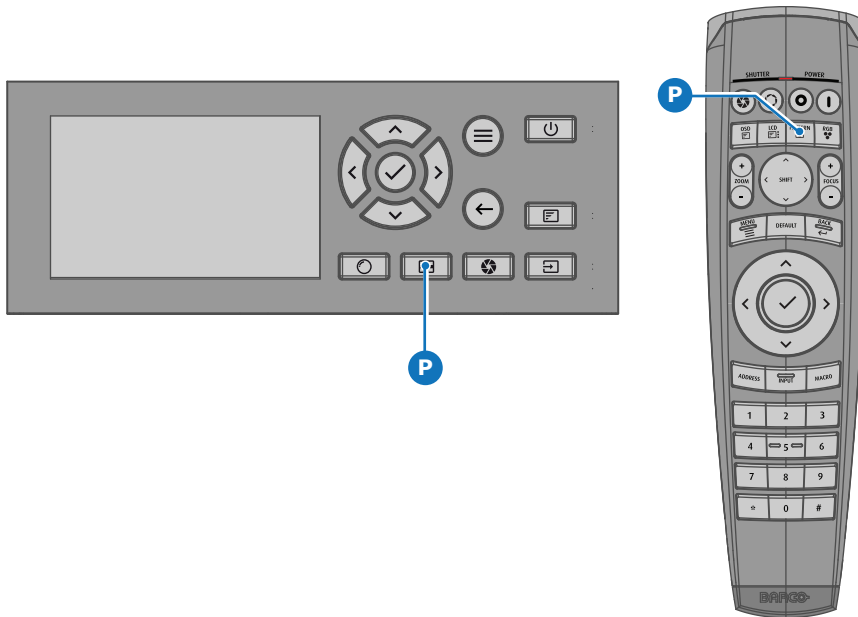

Image 4-10

The *Test pattern* menu opens on the LCD display.

2. Use the arrow keys to select the desired test pattern.

## 4.7 Software update



**CAUTION:** Make sure not to power off or unplug the projector while the software update is going on.

### How to update the software

1. Power on the projector. Wait until the **Power on/off** button is lit white or blue.
2. Download and install the latest version of Projector Toolset for Pulse. The program can be downloaded for free from Barco's website, (URL: <http://www.barco.com>). Click on *myBarco* and log in to get access to secured information. Registration is necessary.

If you are not yet registered, click on *New to myBarco* and follow the instructions. With the created login and password, it is possible to log in where you can download the software.

3. Download the latest firmware (format .fw) from Barco's website in the same way as for Projector Toolset.
4. Start Projector Toolset and make a connection with the projector. For more information, see the Projector Toolset user guide.
5. Select tab **Update settings**.
6. Fill out the path to the update file (1)

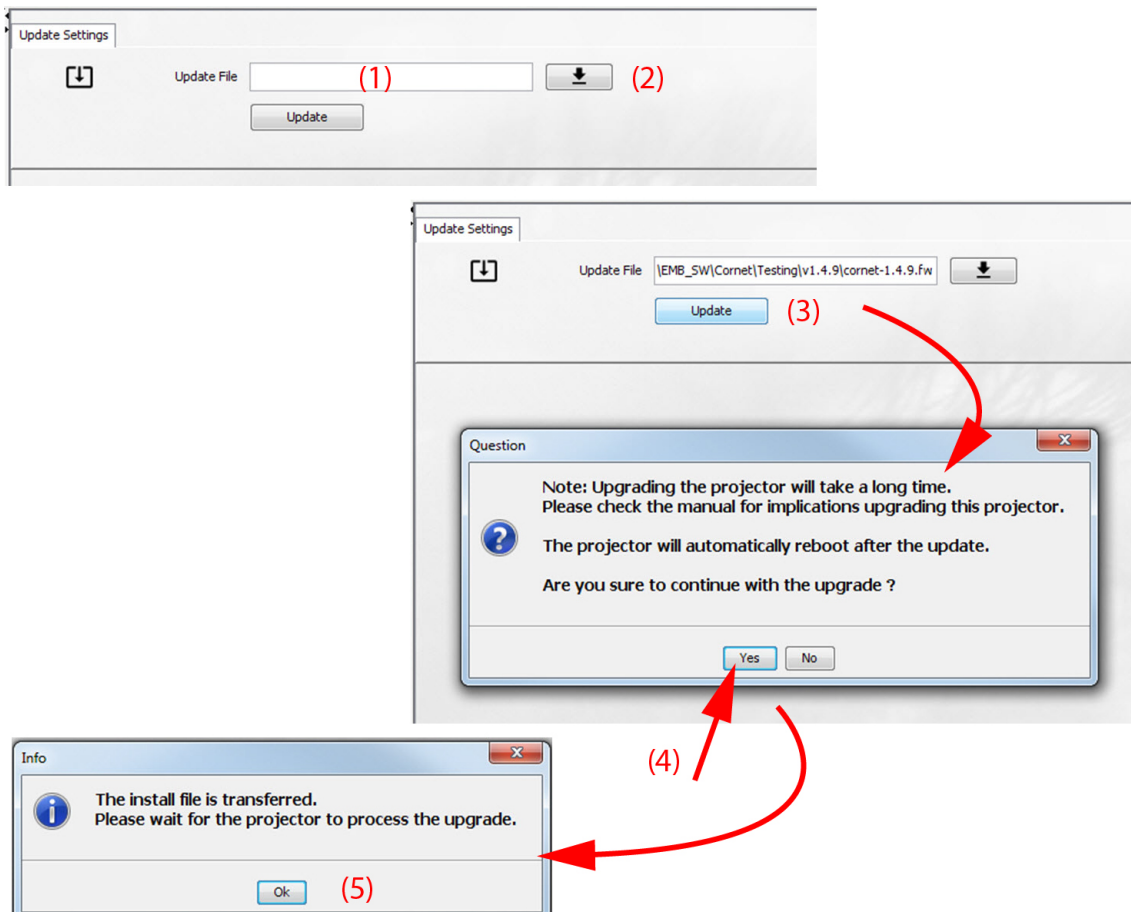

Image 4-11: Update Pulse projector

or  
click on the path selection icon (2) to open a browser window.

7. Browse to the desired update package (format .fw) and click **Select Update Package**.  
The path will be filled out in the input field next to *Update File*.



8. Click **Update** (3).

The update starts. This action can take a long time. A message is displayed.

9. Click **Yes** to continue (4).

The update file will be transferred to the projector and installed. The projector will reboot.

A message is displayed. Click Ok to clear the message.

### How to update the software if the projector isn't connected to the network

1. Power on the projector. Wait until the **Power on/off** button is either lit white or blue.

2. Download the latest firmware file ( format .fw) from Barco's website. The firmware can be downloaded for free from Barco's website, (URL: <http://www.barco.com>). Click on *myBarco* and log in to get access to secured information. Registration is necessary.

If you are not yet registered, click on *New to myBarco* and follow the instructions. With the created login and password, it is possible to log in where you can download the software.

3. Place the firmware file on a clean USB flash drive.



*Note:* Make sure the flash drive is FAT32 compatible & no other files are on the flash drive.

4. Plug the flash drive in the USB port on the Communication Panel.

The update file will be transferred to the projector and installed. The projector will reboot when completed.



Take note that the update process can take a long time to complete.



# Graphic User Interface (GUI)

# 5

## Overview

- Overview
- Navigation
- Test Patterns

## 5.1 Overview

### GUI – Status Screens

While the projector menu is not active, or the projector is Ready or Standby mode, the Status screen are visible. These screens give an overview of the state of the projector and can be navigated through using the left and right arrow keys. The status screens are the following:

- **Dashboard:** The main overview. This screen displays all the chosen options on the projector (chosen source, blending/masking, display mode, etc).
- **Notifications:** The error warning messages that are currently active.
- **About:** General info about the projector. This includes serial number, software version, mounted lens and light source runtime.
- **Preview:** A preview pane of the projected image. If no image is being projected, a test image is displayed instead.



Image 5-1: Example of a Dashboard status screen for the UDX 4k32

### GUI – Main Menu overview

The projector on screen display (OSD) is the primary user interface (UI). From here, you can review and adjust all projector and display settings.

The OSD interface uses tabs to display the main menu. Each main menu contains submenus.

The OSD can be disabled by pressing the OSD on/off button.

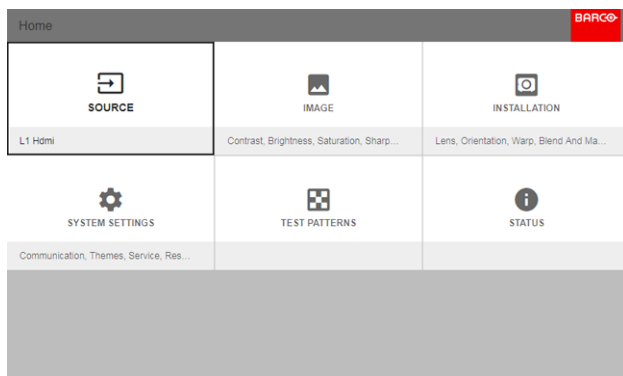

Image 5-2: Home menu

The projector's software platform uses access levels what each user can do. A standard user has access to all projector functionality. A certified service technician has also access to the service menu. This menu is password protected.

## 5.2 Navigation

### Navigation via the RCU or local keypad

Navigating the OSD can be done using the remote control or the local keypad.

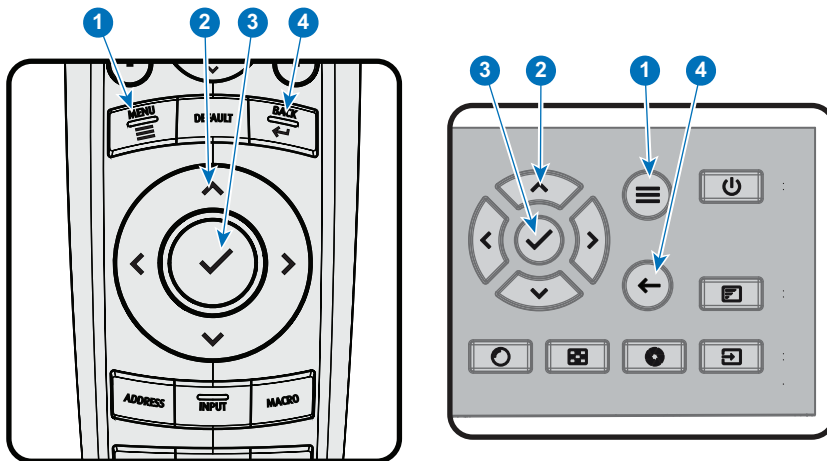

Image 5-3

To start up the menu structure, press **MENU** (1).

Use the arrow keys (**Menu Navigation** buttons) to navigate to the desired menu item (2). The background color changes to light blue.

Press the **Menu Selection** button (center key of the arrow keys), also called **OK** button, to activate that item and to jump one level deeper (3).

Use the numeral keys to enter values, or use the arrow keys to move the bar scale up or down.

Press the **Back** button to go up one level (4).

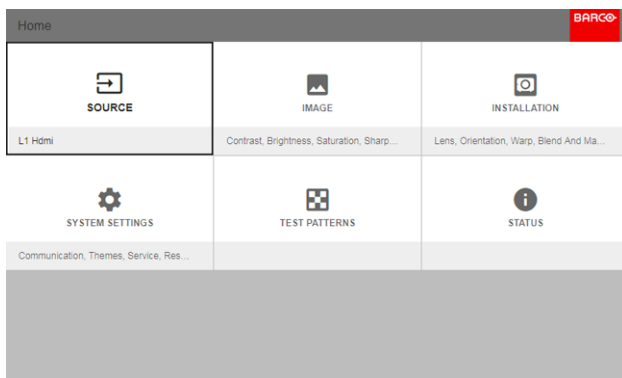

Image 5-4: Home menu

Remark: a blue slider bar on the right side of the window means that there are more items to show than those currently displayed.

### Define values

Menu settings are displayed using check boxes, bar scale sliders, and drop-down lists.

To set a value:

- Press **OK** to select or deselect a checkbox (turn a function ON or OFF).
- Use the arrow keys to move the bar scale slider up or down on the value line. For a bar scale 0-9, each step will equal 10% of the total value.
- To enter the value as a direct number, press **OK**, input the digit(s), and then press **OK** again to execute and exit cursor mode e.g. OK 79 OK.  
Within an input field, use the \* button as backspace button to remove an entered digit. Use the # button to enter a dot (.).

Changes to values are implemented dynamically.

To enter values with the local keyboard, use the arrow keys to select the first digit, press **OK**. Select the second digit and press **OK**. Continue until all digits are entered. Close the action by selecting the **enter** (↵) button and press **OK**. Select the **backspace** button and press **OK** to remove the last entered digit.

### **Menu memory**

The OSD menu remembers the last selected sub-item as long as the projector is running. The menu memory is reset when restarting the projector from standby.

## 5.3 Test Patterns

### How to use test patterns

1. In the main menu, select *Test Patterns*.

or

Push the *Test Patterns* button on the RC.

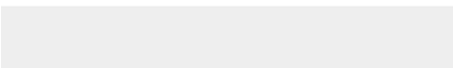

Image 5-5: Main menu, Test Patterns

2. In the Test Patterns menu, select either *Internal*, or *Output* test patterns.
3. In the chosen submenu, select the desired test pattern from the list.

You can select one of the following *Internal* test patterns:

- Color bars
- Checker board
- Blue / Green / Red / White
- Convergence
- Focus
- Aspect
- Scheimpflug White / Green
- Cross hatch
- Monoscope
- 3D Stereo

You can select one of the following *Output* test patterns:

- Blemish zone
- Checkerboard
- Color bars
- Convergence
- FIP
- Full screen black / white / blue / green / red / cyan / magenta / yellow
- Grid
- Horizontal Ramp
- Vertical Ramp
- MTF

4. To turn the test pattern off, return to the previous menu.



# GUI – Source

# 6

## About the Source menu

This menu is used to select, review and configure sources into the projector.

## Overview of features

- Displaying a single source
- Displaying multiple sources: Stitched layouts
- Connector Settings

## 6.1 Displaying a single source

### About selecting a source

Before a source can be projected, the source signal must be connected to the source input(s) of the device and a valid synchronization signal must be available along with the source signal on at least one of the input connectors.

### How to select?

1. Press **Menu** to activate the menus and select *Source*.

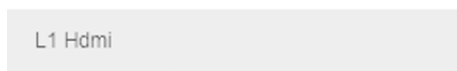

Image 6-1: Select Source

2. Press **OK**.

The *Select Source* menu is displayed with the actual available sources filled out.

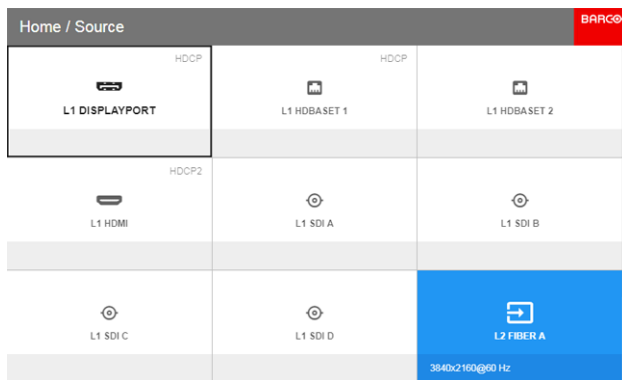

Image 6-2: Input selection

3. Select the desired input.

## 6.2 Displaying multiple sources: Stitched layouts

### About stitched layouts

The first time you use a selected single source, the source will be displayed in the projector's native resolution. If the resolution of the source is different to the projector's resolution, the image is stretched or shrunk.

It is however possible to configure and display two or four source signals to make up one single image in full native resolution. This is called a **Stitched Layout**: the sources are stitched together.

The following table lists which stitched layouts you can use, and in which display mode these layouts can be used.

The table below describes the different Stitch Layouts and scan directions.

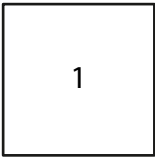
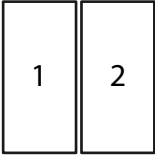
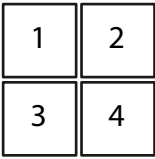
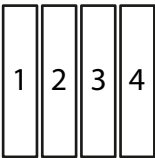
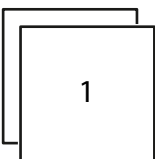
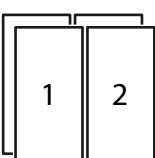
Type of layout	Description	Available connectors	Mode
 : Single	A single source is displayed in full screen	Quad Combo input: <ul style="list-style-type: none"> <li>• SDI (4x)</li> <li>• HDBaseT (2x)</li> <li>• DisplayPort</li> <li>• HDMI</li> </ul> Quad DP 1.2 Input: <ul style="list-style-type: none"> <li>• DisplayPort (4x)</li> </ul>	Mono / Active stereo
 : Dual 1 x 2	Two inputs are required. The sources are displayed next to each other.	Quad DP 1.2 Input: <ul style="list-style-type: none"> <li>• 2x DisplayPort</li> </ul>	Mono / Active stereo
 : Quad 2 x 2	Four inputs are required. The sources are displayed in four quadrants.	Quad Combo input: <ul style="list-style-type: none"> <li>• 4x SDI input</li> </ul> Quad DP 1.2 Input: <ul style="list-style-type: none"> <li>• 4x DisplayPort</li> </ul>	Mono / Active stereo
 : Quad 1 x 4	Four inputs are required. The sources are displayed next to each other.	Quad DP 1.2 Input: <ul style="list-style-type: none"> <li>• 4x DisplayPort</li> </ul>	Mono / Active stereo
 : 2 x single	Two inputs are required. The sources are displayed one above the other.	Quad DP 1.2 Input: <ul style="list-style-type: none"> <li>• 2 x DisplayPort</li> </ul>	Passive stereo
 : 2 x Dual 1 x 2	Four inputs are required. Two sources are displayed next to each other, while the other two are displayed above the first two	Quad DP 1.2 Input: <ul style="list-style-type: none"> <li>• 4x DisplayPort</li> </ul>	Passive stereo



Even if passive stereo sources are selected, the output of this projector can only be in either 2D or in Active Stereo. Advanced image processing will make sure a passive stereo image is properly converted to active stereo.

### How to select a stitched layout

1. Press **Menu** to activate the menus and select *Source*.

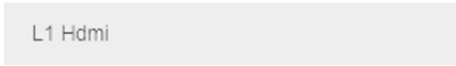

Image 6-3: Select Source

2. Press **OK**.

The *Select Source* menu is displayed with the actual available sources filled out, including all available stitched layout options.

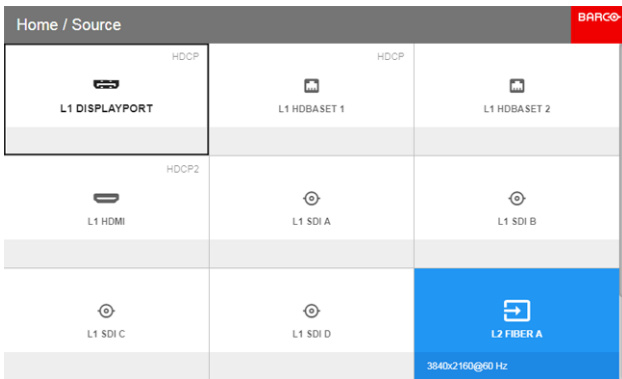

Image 6-4: Input selection menu

3. Select the desired stitched input.



*Tip:* If the V&AR board is installed, scroll all the way down the Input Selection menu for the stitched options on that board.

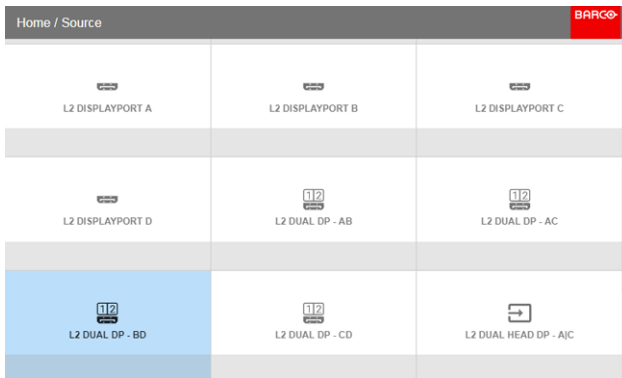

Image 6-5: Input Selection menu, stitched options

## 6.3 Connector Settings

### About Connector Settings

The Connector Settings menu allows you to change settings for each input connector of the projector.

By default all options for every connector are set to automatic, together with the native Extended Display Identification Data (EDID).

When entering the menu for each input connector, you can change the following:

- Color Space
- Signal Range
- EDID

### How to configure a connector

1. Press **Menu** to activate the menus and select *Source*.



SOURCE

L1 Hdmi

Image 6-6: Select Source

2. Press **OK**.

The *Select Source* menu is displayed with the actual available sources filled out.

3. Scroll down to the bottom of the list of available sources and select *Connector Settings*.



CONNECTOR SETTINGS

L1 Displayport, L1 Hdbaset 1, L1 Hdba...

Image 6-7: Source menu, Connector Settings

The available input connectors are displayed.

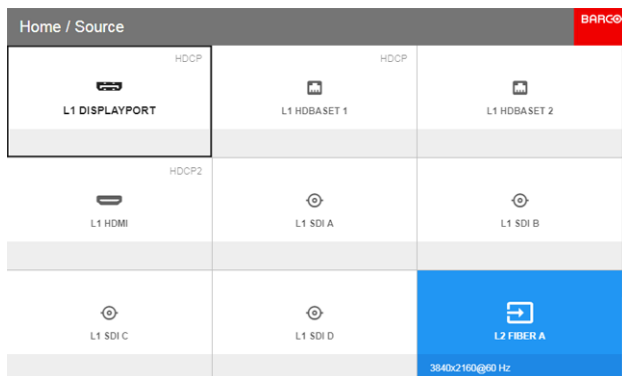

Image 6-8: Select source

4. Select the desired connector.

The **Connector Settings** menu for this connector will be displayed.

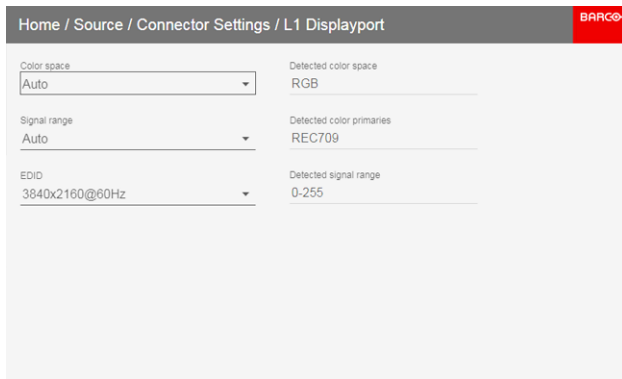



Image 6-9: Example of connector settings for an HDMI connector

5. You can change the following:

- To force a limit on the color space, select one of the available *color spaces*.
- To force a limit on the used signal range, select one of the available *signal ranges*.
- To set a video timing other than the one native for the connector, select one of the options under *EDID*.

 **Note:** You cannot change the EDID for SDI connectors.

# GUI – Image

# 7

## Overview of features

- Setting image levels manually
- Adjusting the sharpness
- Adjusting the gamma correction
- Setting the desired Gamma type
- Digital Shift & Zoom
- P7 Realcolor
- Setting the output resolution
- Displaying HDR content – Perceptual Quantizer (PQ)

## 7.1 Setting image levels manually

### Purpose

**Contrast:** Change the contrast of the complete output signal (main and PiP window together) of the projected image.

**Brightness:** Change the brightness of the complete output signal (main and PiP window together) of the projected image.

**Saturation:** Change the saturation of the complete output signal (main and PiP window together) of the projected image.

### How to set up Contrast

1. In the main menu, select *Image* → *Contrast*.



Image 7-1: Image menu — Contrast

2. Use the ◀ or ▶ key to change the contrast enhancement until the desired value is reached (adjustable between 0 and 2).

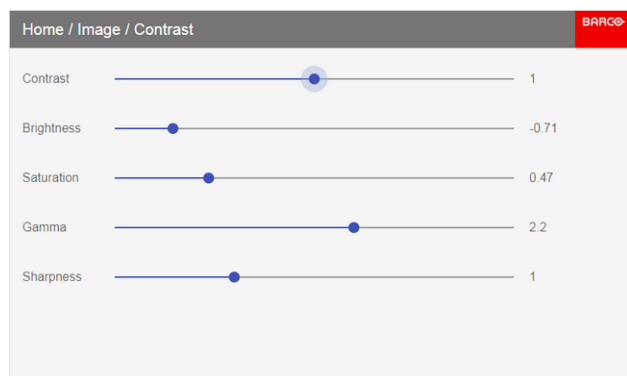

Image 7-2: Contrast slider

3. If necessary, use the ▲ or ▼ key to select the other image adjustment options.

### How to set up Brightness Level

1. In the main menu, select *Image* → *Brightness*.

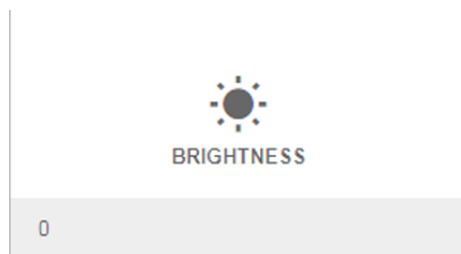

Image 7-3: Image menu — Brightness

2. Use the ◀ or ▶ key to change the brightness until the desired value is reached (adjustable between –1 and 1).





Image 7-4: Brightness slider

3. If necessary, use the ▲ or ▼ key to select the other image adjustment options.

## How to set up Saturation Level

1. In the main menu, select *Image* → *Saturation*.

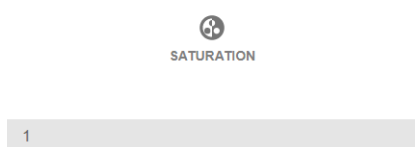

Image 7-5: Image menu — Saturation

2. Use the ◀ or ▶ key to change the saturation until the desired value is reached (adjustable between 0 and 2).

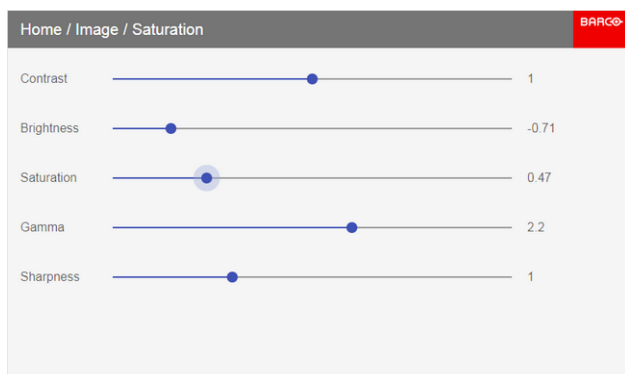

Image 7-6: Saturation slider

3. If necessary, use the ▲ or ▼ key to select the other image adjustment options.

## 7.2 Adjusting the sharpness

### About adjusting the sharpness

The sharpness adjustment amplifies the high frequency components in the picture. This means that by increase the sharpness, the picture will be perceived as sharper, and if decreased, the picture will be perceived as more blurry.

Increasing the sharpness will have the best effect in high contrast images, eg a table with text and borders.

In a natural picture, high sharpness can be perceived as noise, as all details in the picture will be amplified.

Available range: -2 to 8.

Default value: 0

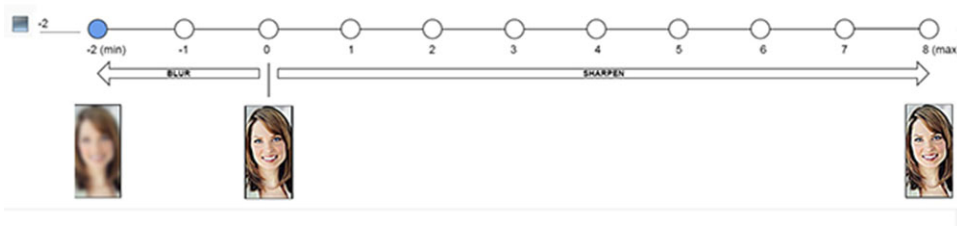

Image 7-7: Effect of sharpness adjust

### How to adjust

1. In the main menu, select *Image* → *Sharpness*.

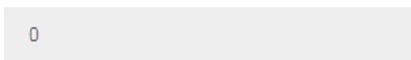
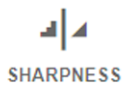

Image 7-8: Image menu — Sharpness

2. Use the ◀ or ▶ key to change the sharpness until the desired value is reached.

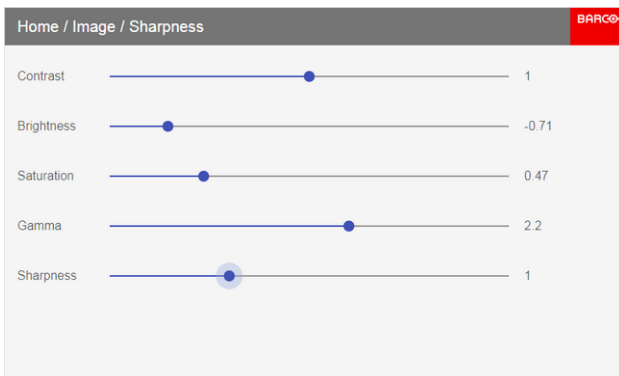

Image 7-9: Sharpness slider

3. If necessary, use the ▲ or ▼ key to select the other image adjustment options.

## 7.3 Adjusting the gamma correction

### About gamma correction

Gamma correction is an image quality enhancement function that offers a richer image by brightening the already darker portions of the image without altering the brightness of the brighter portions (contrast feeling enhanced).

### How to adjust

1. In the main menu, select *Image* → *Gamma*.



2.2

Image 7-10: Advanced menu – Gamma

2. Use the ◀ or ▶ key to change the gamma value between 1.0 and 2.8 . The default value is 2,2.

 **Tip:** The slider can be adjusted with a precision of 0.1.

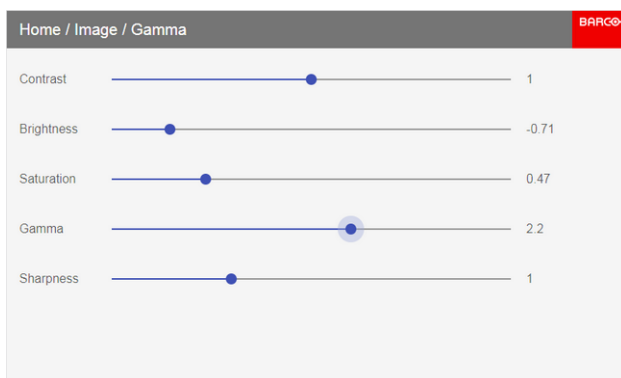

Image 7-11: Gamma slider

3. If necessary, use the ▲ or ▼ key to select the other image adjustment options.

## 7.4 Setting the desired Gamma type

### About the alternate gamma types

Next to the standard gamma correction, the projectors can be manipulated in a way to simulate gamma types for other devices or purposes. This includes sRGB (standard Red-Green-Blue), Power gamma and a number of DICOM gamma ranges.

DICOM gamma ranges are usually reserved for medical displays. While this projector is **not** a certified DICOM display, it can simulate certain specific DICOM gammas at a few selected max light outputs. The DICOM gamma assumes that both ambient light and the projector outputs black as 0 cd/m<sup>2</sup>. Then there will be a few predefined gamma curves at the following light outputs:

- DICOM 10: 10 cd/m<sup>2</sup>
- DICOM 60: 60 cd/m<sup>2</sup>
- DICOM 180: 180 cd/m<sup>2</sup>
- DICOM 250: 250 cd/m<sup>2</sup>
- DICOM 300: 300 cd/m<sup>2</sup>
- DICOM 400: 400 cd/m<sup>2</sup>



Take into account that the available DICOM gamma types may be more limited than this list, depend on your used projector type.



The only alternate gamma that can not be selected in this menu is PQ/HDR. Because the color output of HDR is dependant on extra factors such as screen luminance, a separate menu has been made available for this. For more info on PQ and HDR, refer to “Displaying HDR content – Perceptual Quantizer (PQ)”, page 99.

### How to adjust the gamma type?

1. In the main menu, select *Image* → *Gamma type*.



AUTO

Image 7-12: Image menu — Gamma type

The Gamma type menu is displayed

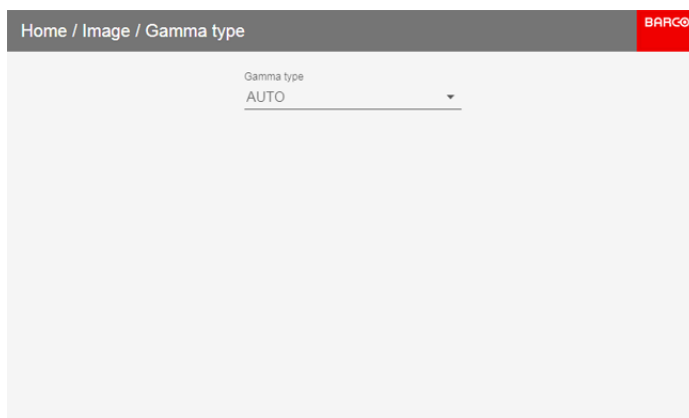

Image 7-13: Gamma type menu

2. Select the desired gamma type.



*Tip:* If not sure what gamma type to select, keep the default value AUTO selected. This will determine the used gamma type based on the incoming signal.

## 7.5 Digital Shift & Zoom

### What can be done?

The image can be optically shifted by using the vertical and horizontal lens shift.

If you want to reach a lens shift beyond what is possible with the optical shift, you can also perform a digital lens shift. This digital shift will occur on the DMD, rather than the lens holder. So take into account that this additional shift is minimal and restricted to the limits of the chip used.

For the optical zoom and lens shift, navigate to *Home* → *Installation* → *Lens*.



Lens shift is only possible when the used lens has been fully calibrated. To calibrate the current lens, navigate to *System Settings* → *Maintenance* → *Lens Calibration*.

### The effect of Digital Zoom

This function zooms in the picture digitally. When zooming in, the center of the image will increase in size. This means that the outer part of the picture will be outside the picture frame. When zooming out, the result is that the picture will be smaller than the projector's picture frame. The area outside the rendered picture will then be black.

For an example, see the following photos. The red lines in the figures represent the DMD outline.



Image 7-14: Originally picture, not digitally zoomed



Image 7-15: Picture digitally zoomed in

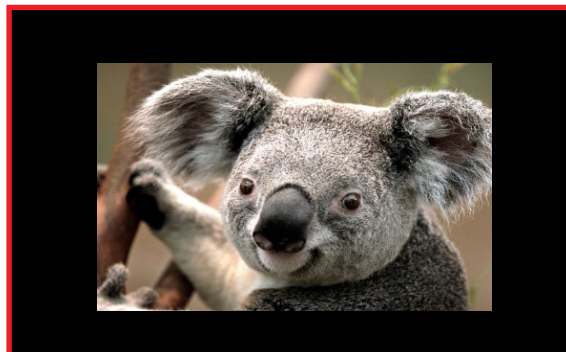

Image 7-16: Picture digitally zoomed out

## The effect of Digital Shift

This function will shift the picture digitally, meaning that the picture will be moved in any direction. As a result, some parts of the picture might be shifted outside the DMD range.

For an example, see the following pictures. The red lines in the figures represent the DMD outline



Image 7-17: Original Picture, not digitally shifted

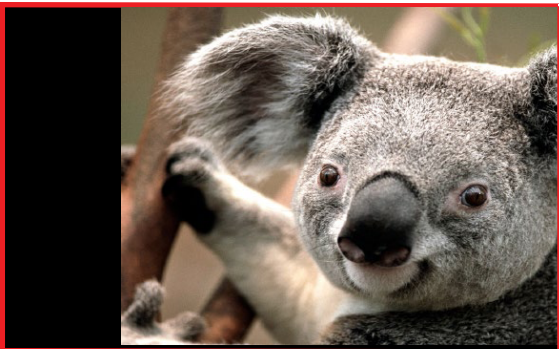

Image 7-18: Picture shifted horizontally

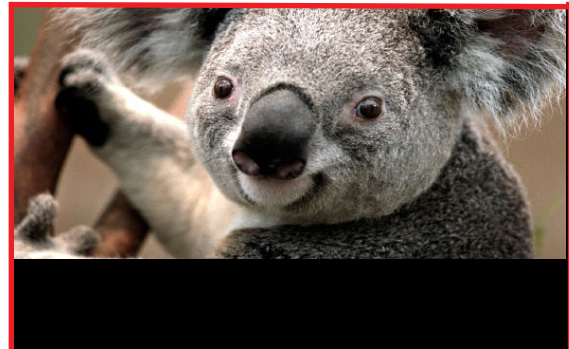

Image 7-19: Picture shifted vertically

## Digital Shift & Zoom

1. In the main menu, select *Image* → *Digital Zoom Shift*.

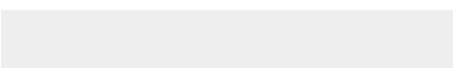
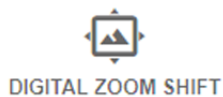

Image 7-20: Image menu, Digital Zoom Shift

The Digital Zoom Shift menu is displayed.

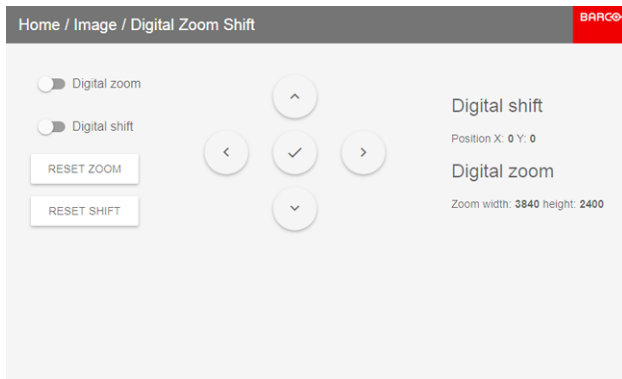

Image 7-21: Digital Zoom Shift menu

2. In order to optimize the digital zoom, enable **Digital Zoom**.

When enabled, you can do the following:

- Use the ▲ or ▼ key to zoom the lens in or out.
- Use the ◀ or ▶ key to focus the lens to far or near.

3. In order to optimize the digital shift, enable **Digital Shift**.

When enabled, you can do the following:

- Use the ◀ and ▶ keys to shift the lens (image) in horizontal direction.
- Use the ▲ and ▼ keys to shift the lens (image) in vertical direction.

## 7.6 P7 Realcolor

### Purpose

When blending images from multiple projectors, the measured color coordination of each projector can be altered to a desired common level. This so that the projected colors are identical over all projectors used.

Alternatively, if you are unfamiliar with how adjusting the Colors to a specific setting, there are also a certain number of presets available, which forces the color output to specific color standards.

### How to set custom P7 values

1. In the main menu, select *Image* → *Advanced* → *P7 Realcolor*.



Image 7-22: Advanced menu — P7 Realcolor

The P7 menu is displayed.

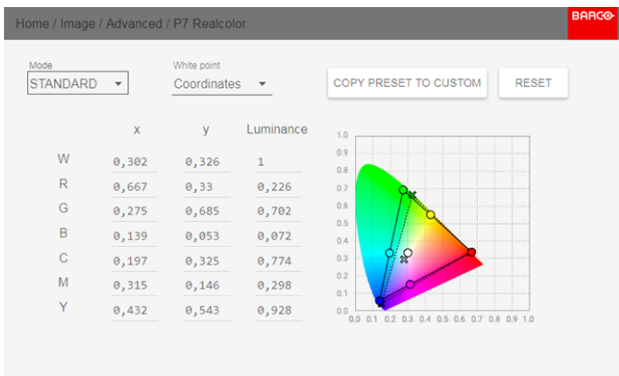

Image 7-23: P7 Realcolor menu

2. Select the desired *Mode*. Choose one of the following *custom* options:
  - **Custom RGB:** 3–point color configuration. In RGB mode, the C, M and Y coordinates will be calculated automatically based on the R, G and B coordinates.
  - **Custom RGBCMY:** 6–point color configuration (both RGB and CMY). In RGBCMY mode, each color can be given a specific coordinate within the measured color triangle.
  - **Custom WHITE:** Configure only the White temperature.

3. Define the coordinates for each available color.

Click on a coordinate value and select the current value. Enter the desired value with the numeric keys.



*Note:* You can only pick coordinates within the measured color triangle.

4. For **Custom White**, click on White point and choose one of the following:

- **Coordinates:** Configure the white point via specific coordinates. The white point is specified using an x, y coordinate in the CIE 1931 Chart.
- **Temperature:** Configure the white point via a color temperature slider. The white point is specified on a Kelvin scale between 3200K and 13000K tracking along the black body curve.





You can reset all coordinates to the default values (to native) by selecting Reset modes to native. Press **OK** button to reset.

## How to choose one of the P7 presets

1. In the main menu, select *Image* → *Advanced* → *P7 Realcolor*.



Image 7-24: Advanced menu — P7 Realcolor

The P7 menu is displayed.

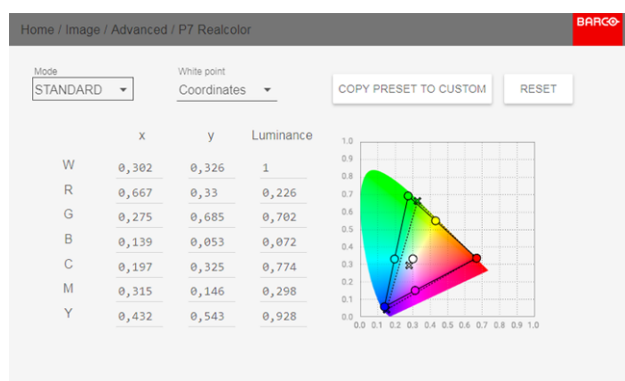

Image 7-25: P7 Realcolor menu

2. Choose one of the pre-defined presets:

- **Standard:** A color standard for all UDX projectors, which may be considered the new native settings for all UDX projectors. Default for UDX.
- **Native:** Projector native color settings.
- **DCI-P3:** Color standard for Cinema.
- **EBU:** European color standard for broadcasting.
- **SMPTE-C:** American color standard for broadcasting.
- **Rec. 709:** Color standard for high-definition televisions (HDTV).

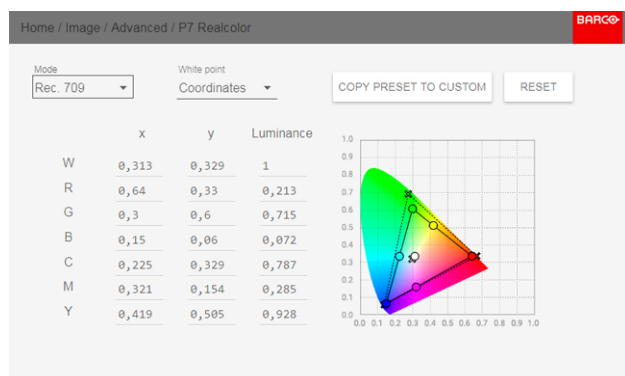

Image 7-26: Example of one of the presets: Rec. 709



**Note:** After choosing one of the presets, you can still alter the values of the coordinates to your own choosing, similarly to how you set custom P7 values. Use **Reset** to return to the default values of the chosen preset.

## 7.7 Setting the output resolution



This menu is only available on the 4k models, with an actuator included.

### How to choose the output resolution

1. In the main menu, select *Image* → *Advanced* → *Output resolution*.



Image 7-27: Advanced menu, Output resolution



*Tip:* The current active output resolution is indicated at the bottom of the selection button.

The Output resolution menu is displayed.

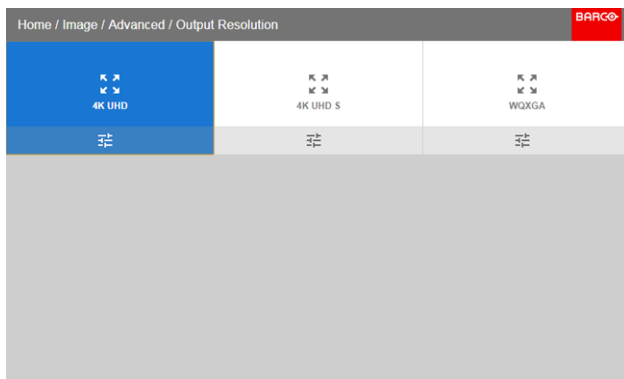

Image 7-28: Advanced menu — Output resolution

2. Select the desired output resolution.

Possible resolutions:

- 4K UHD: 4k images, using the actuator at normal frequency.
- 4K UHD S: 4k extra sharp images, using the actuator at a higher frequency
- WQXGA: 2k images. In this mode, the actuator is disabled.



If the main purpose of the projection is **image** (pictures, movie, or similar purpose), use the **4K UHD** output resolution for the best image at the highest light output.  
 If the main purpose of the projection is **text** (spreadsheets, presentations, or similar purposes), use the **4K UHD S** output resolution for the for the most stable and sharpest output.

## 7.8 Displaying HDR content – Perceptual Quantizer (PQ)

### About PQ

Perceptual Quantizer (PQ) is a non-linear electro-optical transfer function (EOTF) that allows for the display of High Dynamic Range (HDR) content with a luminance level of up to 10 000 cd/m<sup>2</sup> and can be used with the Rec. 2020 color space.

### How to properly display HDR content?

If your provided HDR content has been mastered with PQ (e.g. HDR10 and Dolby Vision), a few changes can be made in order to project the intended mastering on screen. These changes are necessary because HDR content has been mastered specifically for HDR capable displays that are watched in living rooms. These conditions are different from a non-HDR projector and darker cinema-like environments.

The projected HDR content depends on the following factors:

- **Mastering luminance:** This is content-specific and cannot be changed.
- **Screen luminance:** Every projection screen has a specific luminance (measured in nits or foot-lambert). Entering this luminance in the projector will adapt the content towards the intended HDR result.
- **HDR Boost:** A variable “booster” that may amplify or downplay the HDR output.

### How to set the PQ?

1. In the main menu, select *Image* → *Advanced* → *PQ*.



Image 7-29

The PQ menu is displayed.

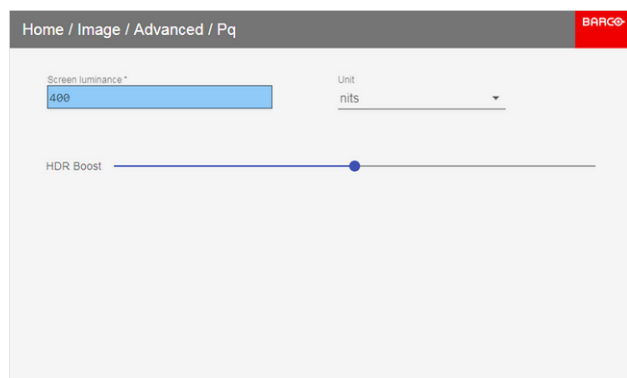

Image 7-30

2. Select the desired Unit (nits or foot-lambert).
3. Enter the Screen luminance (either in nits or foot-lambert).
4. Alter the HDR boost if necessary. You can modify this value to somewhere between 0.8 and 1.2.



# GUI – Installation

# 8

## Overview of features

- Configuring the lens, optical zoom-focus
- Configuring the lens, shift
- Configuring the lens, Mid position
- Laser ranging
- Manipulating the rigging frame
- Orientation
- Warping
- Blending & masking
- Laser illumination
- Setting up the external cooler
- Scaling modes
- 3D projection

## 8.1 Configuring the lens, optical zoom-focus

### What can be done?

Once a lens has been installed in the projector, you can fine-tune the projected image.

### Zoom - Focus

1. In the main menu, select *Installation* → *Lens* → *Zoom focus*.

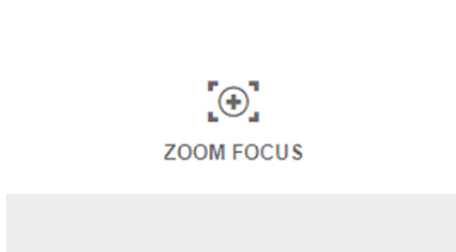

Image 8-1: Lens menu, Focus & Zoom

2. Use the ▲ or ▼ key to zoom the lens in or out.  
Use the ◀ or ▶ key to focus the lens to far or near.

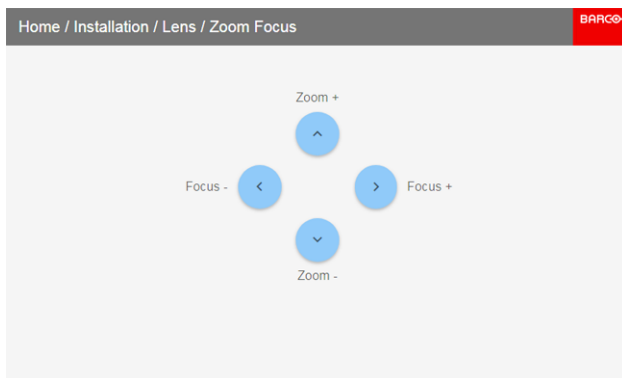

Image 8-2: Zoom and focus adjustment

## 8.2 Configuring the lens, shift

### What can be done?

The image can be optically shifted by using the vertical and horizontal lens shift.

If you want to reach a lens shift beyond what is possible with the optical shift, you can also perform a digital lens shift. This digital shift will occur on the DMD, rather than the lens holder. So take into account that this additional shift is minimal and restricted to the limits of the chip used.

For the digital zoom and shift, navigate to *Home* → *Image* → *Digital Zoom Shift*.



Optical lens shift is only possible when the used lens has been fully calibrated. To calibrate the lens, navigate to *System Settings* → *Maintenance* → *Lens Calibration*.

### Vertical and Horizontal Shift

1. In the main menu, select *Installation* → *Lens* → *Shift*.

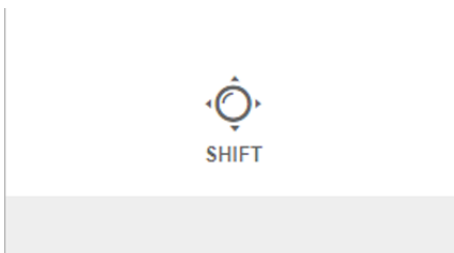

Image 8-3: Lens menu, Lens shift

The Lens shift menu is displayed.

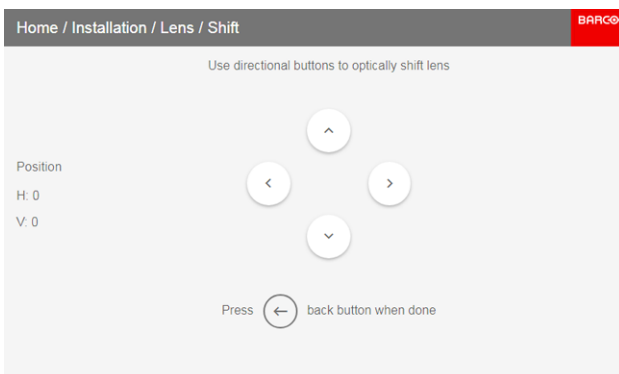

Image 8-4: Lens shift menu

2. Use the ◀ and ▶ keys to shift the lens (image) in horizontal direction.  
Use the ▲ and ▼ keys to shift the lens (image) in vertical direction.

## 8.3 Configuring the lens, Mid position

### What can be done?

The lens can be force back to the center position by selecting **MID LENS** and confirming.

### How force lens in Mid position

1. To force lens in Mid position, select *Installation* → *Lens* → *Shift to Center*.
2. Confirm by selecting **OK**.

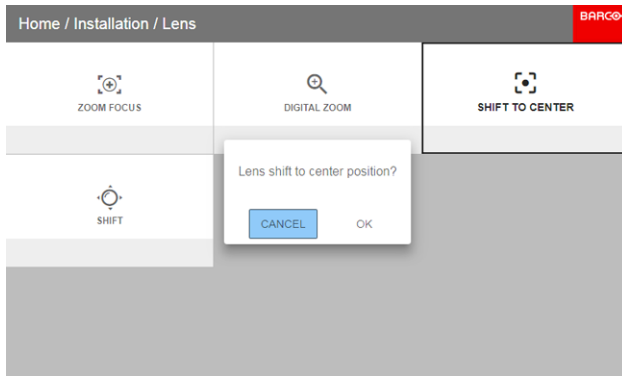

Image 8-5

The lens will calibrate itself and return to the center position.



## 8.4 Laser ranging

### What can be done?

When the optional laser range finder is installed on the projector, you can use the laser source to measure the distance between the front of the projector and the surface you are projecting on.

This can help you fine-tune the position of the projector.



Take into account that while a laser ranging session is active, the projected image will be off. This to have no interference between laser pointer and projected image. Instead, a red border will be projected giving the outline of where the projected image should be.

### How to manipulate the laser range finder?

1. In the main menu, select *Installation* → *Laser ranging*.



0m

Image 8-6: Installation menu, laser ranging

The Laser ranging menu is displayed.

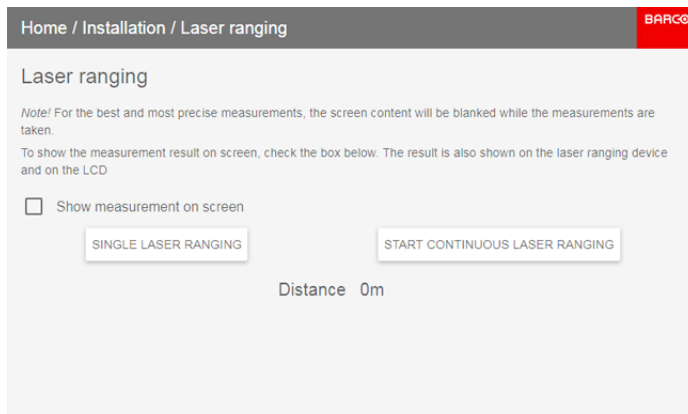

Image 8-7: Laser ranging menu

2. For a single laser ranging calculation, press *Single Laser ranging*. This will continue the laser for 30 seconds.
3. If you want a continued laser ranging (e.g. when fine-tuning the position of the projector), press *Start Continuous Laser Ranging*.
4. If you cannot see the display of the laser range finder while performing a laser ranging session, select *Show measurement on screen*. This way, the measurement will be projected alongside the laser dot and the red border.

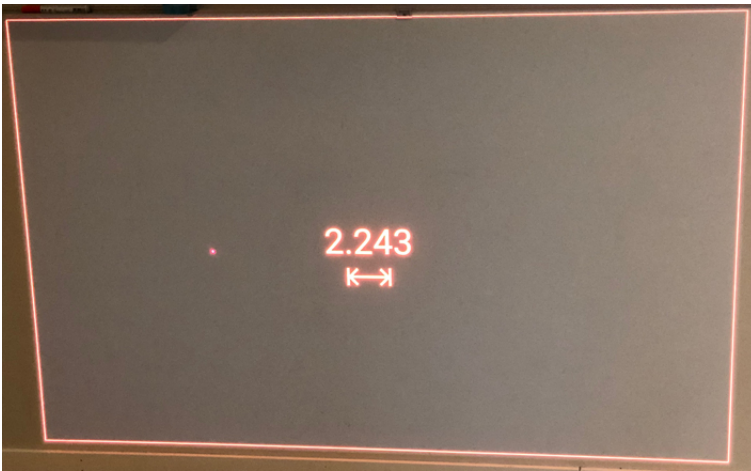

Image 8-8: Example of projected image during laser ranging session with measurement on screen



By default the measurement is in meters. If you want the distance projected in feet, you can change the measurement system in the System settings menu. For more info, refer to “Setting the measurement system”, page 171.

## 8.5 Manipulating the rigging frame

### When can you manipulate the rigging frame?

You can manipulate the rigging frame in the Pulse menu when:

- The projector is mounted in a motorized rigging frame.
- The wiring of the motorization is connected to the projector, including the XLR connector.
- The XLR connector is enabled and powered to 24V. For more info on how to power the XLR connector, see “Front XLR output voltage control”, page 168.

### How to manipulate the rigging frame?

1. In the main menu, select *Installation* → *Lens* → *Frame*.



Image 8-9: Lens menu – frame

The Frame shift menu is displayed.

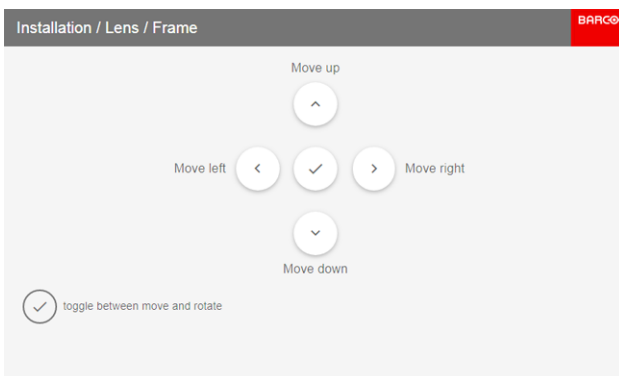

Image 8-10: Frame shift menu

2. Use the ▲ or ▼ button to shift the rigging frame (image) in vertical direction.  
Use the ◀ or ▶ button to shift the rigging frame (image) in horizontal direction.
3. Confirm with the OK button.

The frame rotation menu is displayed.

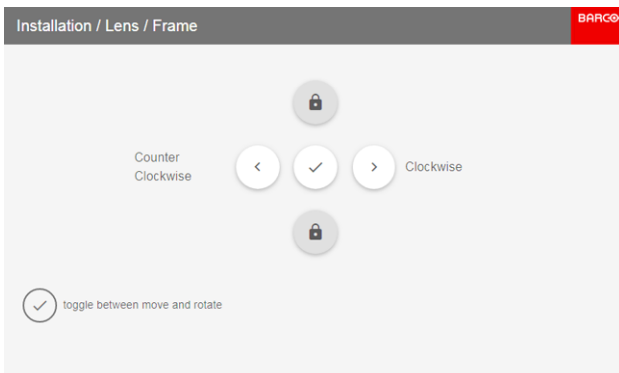

Image 8-11: Frame rotation menu

4. Use the ◀ or ▶ button to rotate the rigging frame (image) either clockwise or counterclockwise.
5. Confirm with the OK button to return to the frame shift menu, or use the Menu back button to return to the Lens menu.

## 8.6 Orientation

### What can be done?

The way of physical installation of the projector can be defined to the projector.

The following installation are possible:

- front/table
- front/ceiling
- rear/table
- rear/ceiling

### How to set the correct orientation

1. In the main menu, select *Installation* → *Orientation*.

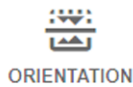

Image 8-12: Installation menu, Orientation

The Orientation menu is displayed.

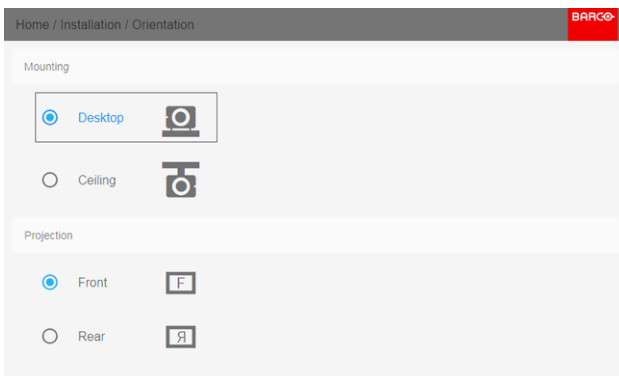

Image 8-13: Orientation menu

2. Use the ▲ or ▼ key to select the desired mounting position and press **OK** button to activate.  
Use the ▲ or ▼ key to select the desired projection position and press **OK** button to activate.

## 8.7 Warping

### About warping

Image warping is the process of digitally manipulating an image to compensate for the distortion of the screen. Consequently, it can also be used to generate an image with irregular shape.

While an image can be transformed in various ways, pure warping doesn't affect the colors.

### Overview

- Warping – On/Off
- Warping – Screen Size
- Warping – 4 corners adjustment
- Warping – Bow
- Warping – Warp files
- Warping – Latency control in a multi projector setup

## 8.7.1 Warping – On/Off

### About warping on/off

By toggling between on and off the warping functionality can be enabled or disabled.

### How to toggle

1. In the main menu, select *Installation* → *Warp*.



Warp, Screen Size, 4 Corners, Bow, Files

Image 8-14: Installation menu, Warp

The Warp menu is displayed.

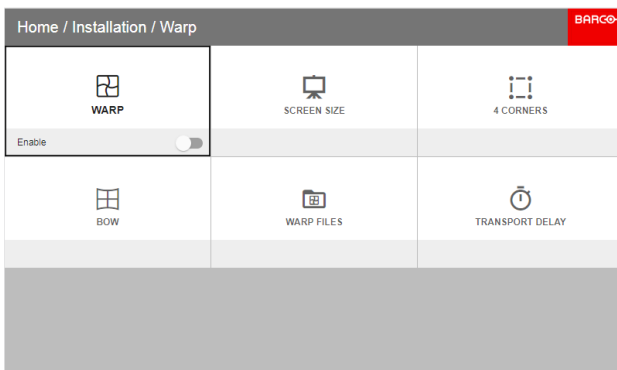

Image 8-15

2. In the Warp menu, click *Warp* to toggle between *On* and *Off*.



Image 8-16

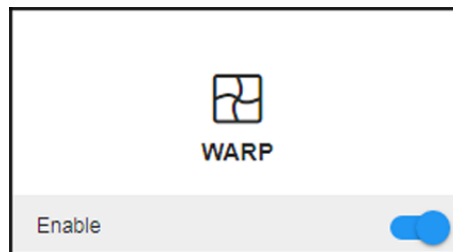

Image 8-17

## 8.7.2 Warping – Screen Size

### About (Warp) Screen Size adjustment

If the used source aspect ratio is different than the projector aspect ratio, e.g. source is 16:9 and projector is 16:10, then black bars will be projected. In the example case a black bar on top and bottom of the image will be projected. The warp area contains not only the image information but also the black bars. If we want to position e.g. the active left top corner exactly on the screen using 4 corner warp, then it is very hard to do that as we are moving the black left top corner and we do not have control over the exact position of image left top corner. By moving the outline of the warp screen size to the active image information, the corner points of the warp area are now exactly on the corner points of the active image information and makes warping much easier.



Image 8-18: Warp outline example

### How to adjust the image?

1. In the main menu, select *Installation* → *Warp* → *Screen Size*.



Image 8-19: Warp Menu, Screen Size

The Screen Size menu is displayed.



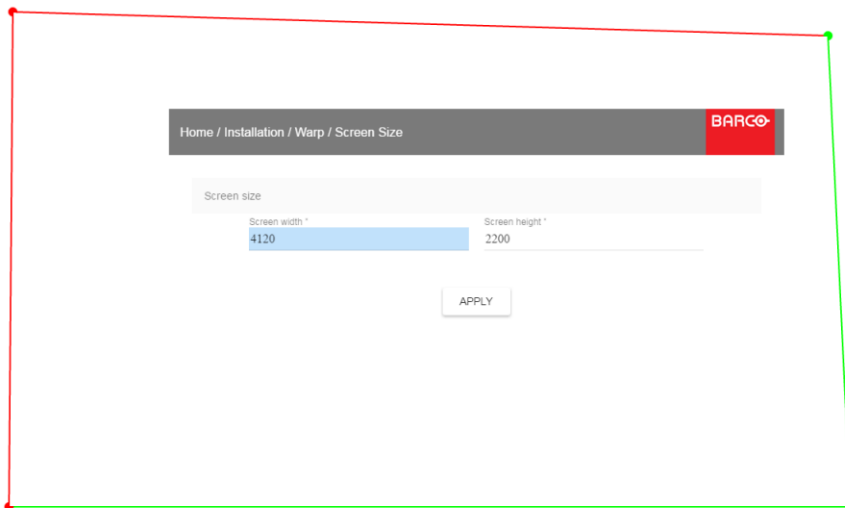



Image 8-20: Screen size

2. Select either *Screen width* or *Screen height*.
3. Set the new value to shrink either the width or height of the warp outline so that the outline is equal with the active source.
  -  *Tip:* A red border will be projected along with the current image. The border is a visual tool, showing the result of the adjusted outline.
  -  *Tip:* The value can also be entered by the numeric keys on the remote control. Press \* to delete existing numbers, and enter the new value by the numeric keys.
4. Click **Apply**.

## 8.7.3 Warping – 4 corners adjustment

### About 4 Corners adjustment

4 corner adjustment is typically used when the mechanical installation of the projector prevents it from pointing perpendicularly at the screen. For example, you can overshoot the screen and use 4 corner adjustment to pull your projected image corners back into the screen.

Some examples:



Image 8-21: 4 corner adjustment

### How to adjust the image?

1. In the main menu, select *Installation* → *Warp* → *4 Corners*.

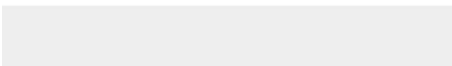

Image 8-22: Warp menu, 4 Corners

The 4 Corners menu is displayed.

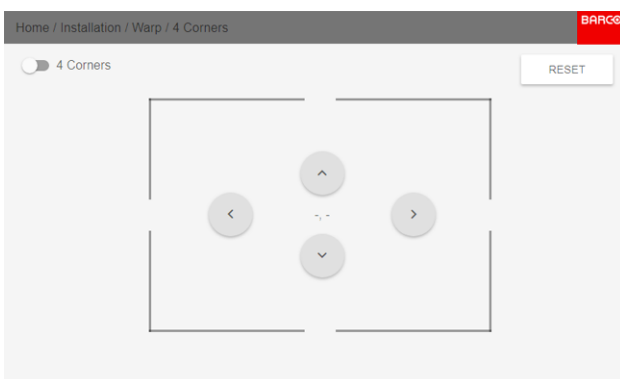

Image 8-23: 4 Corners Warping

2. To enable 4 Corners warping, make sure the *4 corners* slider is set to *On*.

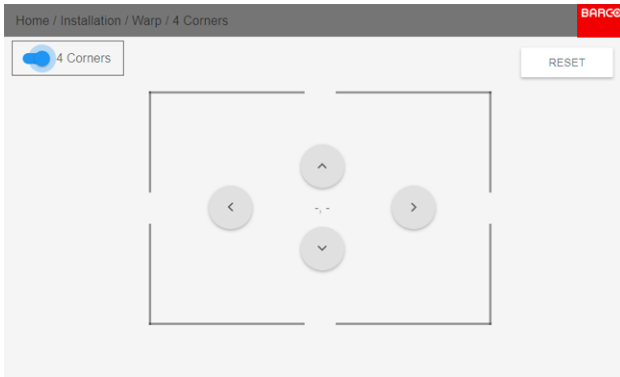

Image 8-24

The slider is enabled when set to the right and when it is colored blue.

3. Use the arrow keys to select the four corners and confirm. The corners will be colored blue.

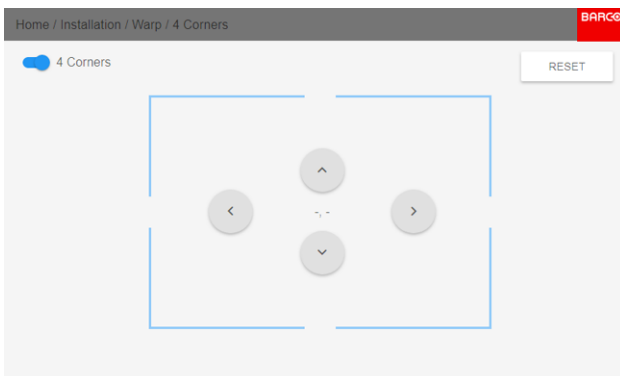

Image 8-25

4. To set warping on one of the four corners, select one of the four corners and confirm.
5. Set the desired X and Y coordinates for this corner, using the arrow keys, and confirm.

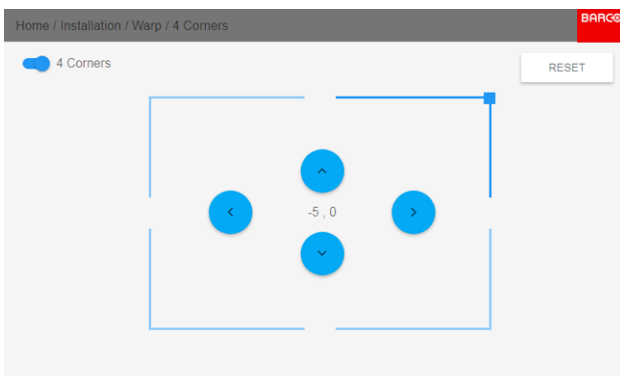



Image 8-26

 **Tip:** A red border corner will be projected along with the current image. The border is a visual aid, showing the result of the warped corners.

6. Repeat from for each corner, until all corners are warped in the desired position.

 To reset the 4 corner adjustments, select *Reset* and press the **OK** button.

## 8.7.4 Warping – Bow

### About bow adjustment

A bow distortion can be adjusted so that a normal image is displayed. Positive adjustments introduce more outside bow distortion. Negative adjustments introduce more inside bow distortion.

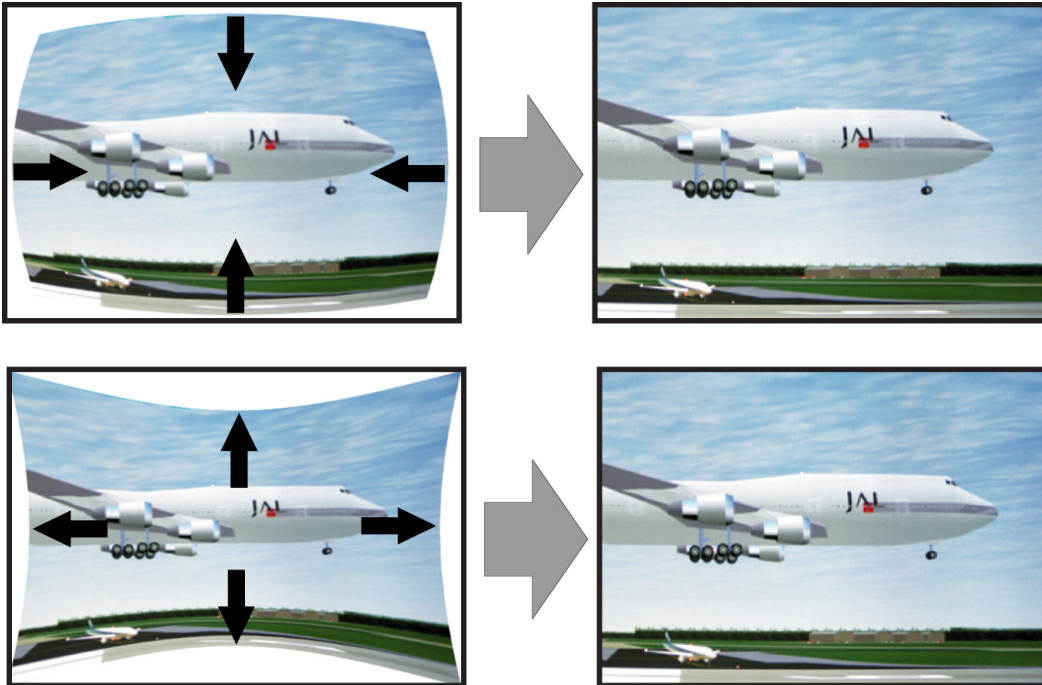

Image 8-27: Bow distortion

### Symmetric bow correction

1. In the main menu, select *Installation* → *Warp* → *Bow*.



Image 8-28: Warp menu, Bow

2. To enable Bow correction, make sure the *Bow* slider is enabled (visible by the blue highlight).
3. To perform a symmetric adjustment, make sure the *Symmetric* slider is set to *On* (visible by the blue highlight).

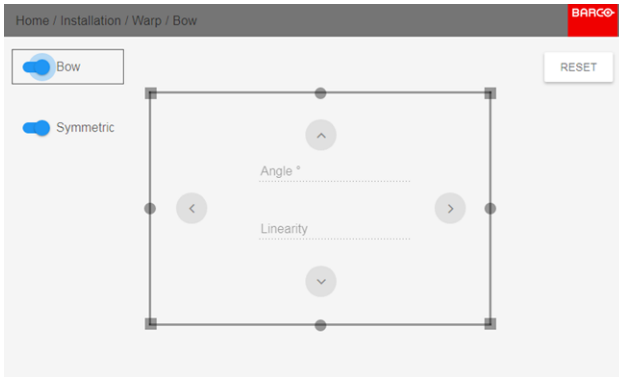

Image 8-29: Bow menu – both Bow and Symmetric sliders are set to On

4. Use the arrow keys to select the helping lines that represent the picture and confirm. The helping lines that represent the projected picture are now colored blue.

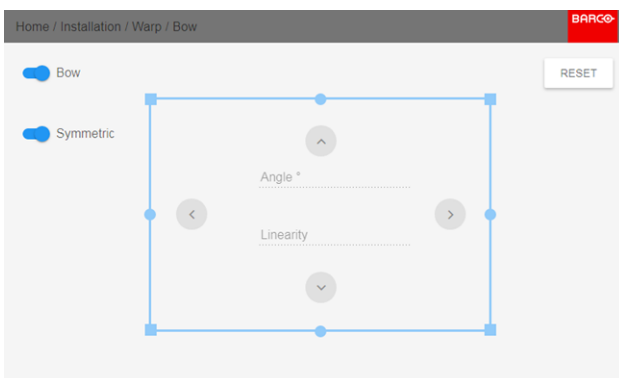

Image 8-30

5. Use the arrow keys to select the side of the picture that needs a correction and confirm.

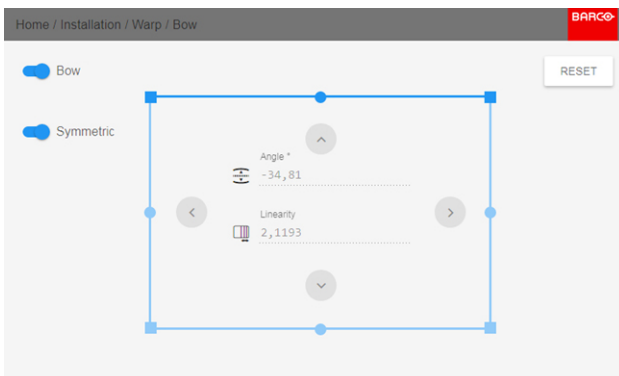



Image 8-31: Symmetric Bow correction.

6. Use the arrow keys to adjust the angle and linearity (length) of the vectors.

 **Tip:** The angle is adjusted by using the up and down arrow keys. The linearity is adjusted by using the left and right arrow keys.

The correction will occur symmetrically on each side of the center of the highlighted side.

7. Repeat this step for all sides of the picture that has to be corrected, until the desired transformation has been achieved.

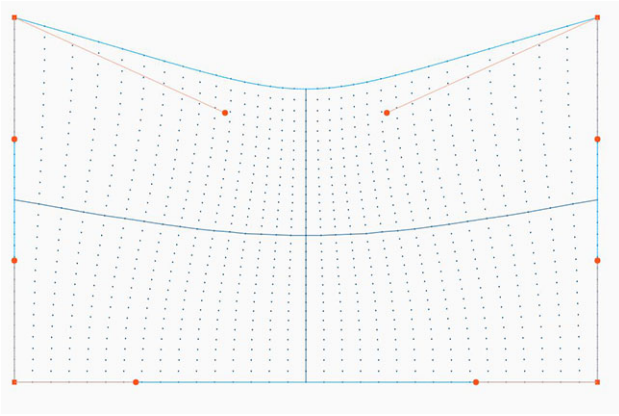

Image 8-32: Example of a symmetric bow correction

### Non symmetric bow correction

1. In the Bow menu, enable the Bow slider and disable the symmetric slider.

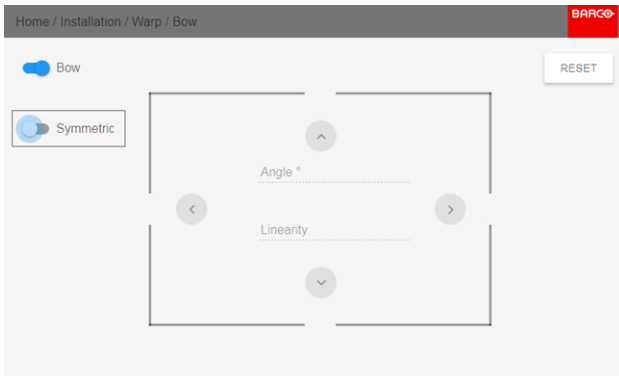

Image 8-33

There are now two vectors on each side of the picture that can be adjusted individually.

2. Select the desired slider and confirm.

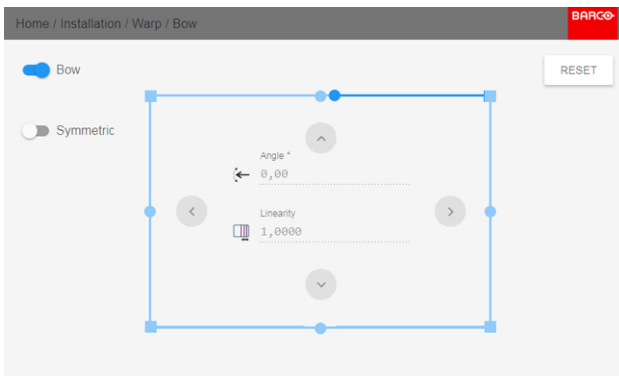

Image 8-34: Right vector of the upper side of the picture.

3. Adjust angle and linearity (length) individually to obtain the correct correction and confirm.



*Tip:* Adjust the angle by using the up and down arrow keys. Adjust the linearity by using the left and right arrow keys.

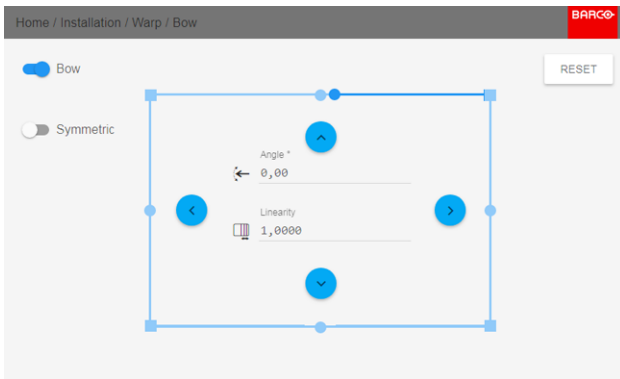

Image 8-35

- Repeat the step for each side of the picture that must be corrected.

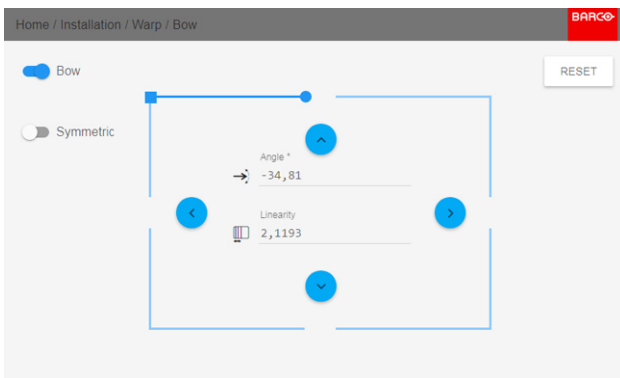

Image 8-36: Left vector of the upper side of the picture.

- When completed, a transformation will occur in a way similar to the following example. Observe that the upper side of the picture now has an asymmetric correction.

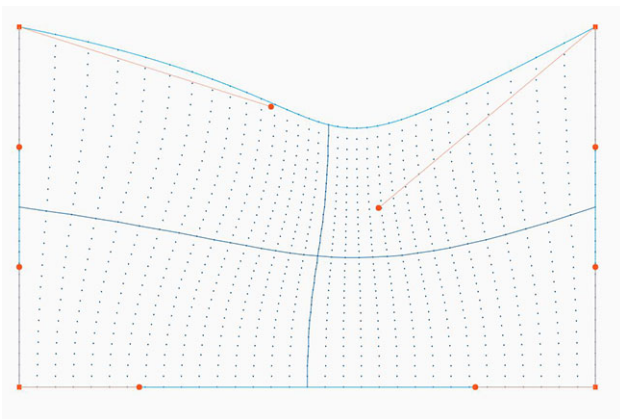

Image 8-37: Example of an asymmetric bow correction

## Definition of angle and linearity (length) in the bow warp procedure

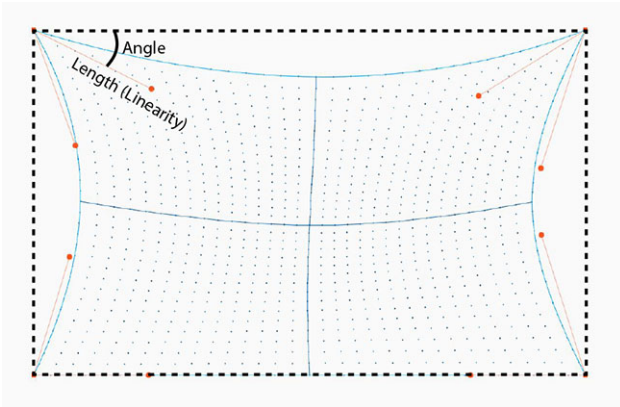

Image 8-38



To reset the bow adjustments, select *Reset* and confirm.



## 8.7.5 Warping – Warp files

### About custom Warp Files

Next to setting your specific warp configuration in the GUI, you can also upload or download a custom warp grid in XML format to/from the projector. This is a time-saving option when multiple projectors need an identical Warp configuration.

To upload or download warp files you can use Projector Toolset or Prospector tool to upload/download the warp grid in the format of an XML file. Alternatively, you can contact the “file endpoint” directly via the curl program or some other tool that supports http upload.

For more information on uploading/downloading Warp files using the Projector Toolset, refer to the Projector Toolset user manual.

For more information on uploading/downloading Warp files using curl or other tools that supports HTTP upload, refer to the Pulse API Reference Guide.



When uploading a warp file that is too big, or with warp parameters outside the limits of the projector, some irregularities can occur. It will show up in two ways:

1: No warp enabled, picture still unwarped.

2: Distortions and artifacts in the edges of the picture.

There will be no error messages or warnings in the display when this occurs. The above mentioned symptoms is the only indication of this case.

### How to activate an uploaded Warp grid?

1. In the main menu, select *Installation* → *Warp*.



WARP

Warp, Screen Size, 4 Corners, Bow, W...

Image 8-39: Installation menu, Warp

2. In the Warp menu, select *Files*.



WARP FILES

Image 8-40: Warp menu, Files

The Warp Files menu is displayed.



Image 8-41

3. If any custom Warp files are available, select the desired warp file.

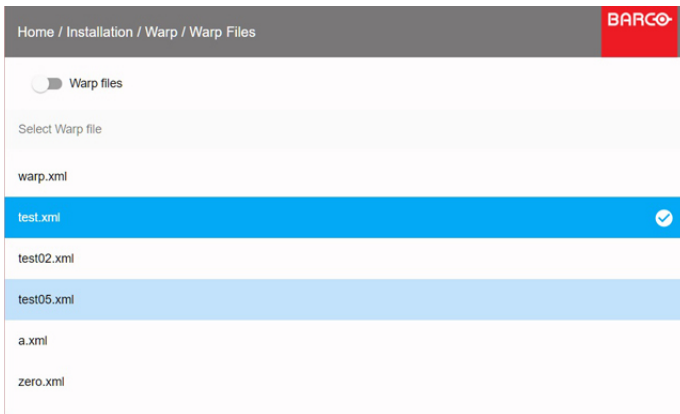

Image 8-42

4. Click on the on/off button on top to activate the selected warp file.



Image 8-43

## 8.7.6 Warping – Latency control in a multi projector setup



### Transport latency

The added delay in the image processing chain. The value is the number of lines relative to the output resolution.



### Latency

The total time from the first pixel is coming in on an input source, until the first light representing that pixel is visible on the screen. This includes the transport delay. The value is normally given in milliseconds.

### Functional description

Every projector in a multi-projector setup will have a different latency. This latency depends on the amount of warp and on the frequency of the projected image. In order to have no visible difference in the overall projected image, the user needs to be able to control the latency of each projector.

The latency value can be read out in the status menu for each individual projector.

### How to configure transport delay?

1. Read out and note the latency of each projector in the multi-projector setup. You can find this latency under **Transport delay** in the status menu for each projector.

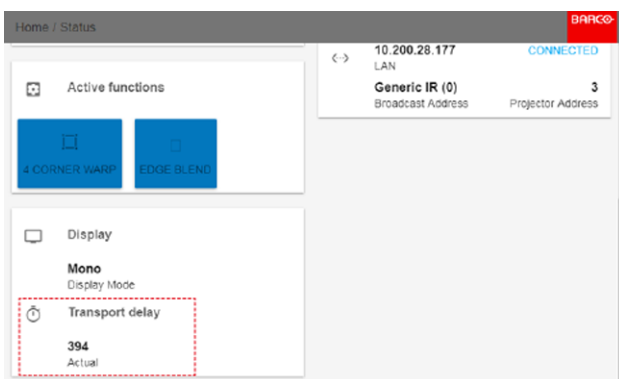

Image 8-44

2. Identify the projector with the longest delay.
3. For each projector in the setup, select *Installation* → *Warp* in the main menu.



WARP

Warp, Screen Size, 4 Corners, Bow, W...

Image 8-45: Installation menu, Warp

4. In the Warp menu, select *Transport Delay*.



Image 8-46: Warp menu, Transport delay

The Transport menu is displayed.

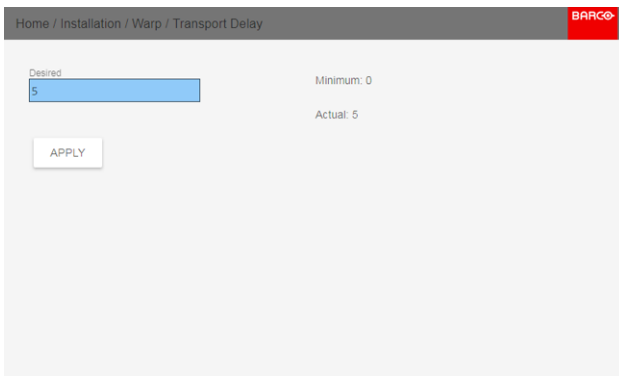

Image 8-47

5. Enter the value either by the arrow keys (one step at a time) or directly by the numeric keys on the remote control.
6. Enter “Apply” to confirm the value.
7. Repeat this process for every projector in the setup.

## 8.8 Blending & masking

### About Blending & Masking

Blending is used in multi channel installation to have a seamless transition between the channels. Image blending gives the appearance of a single view, thus achieving realistic immersion for the majority of wide screen applications.

The principle is that the light intensity in the blend zone from each projector will be adjusted individually, so that the rendering on the screen are perceived as from one projector.

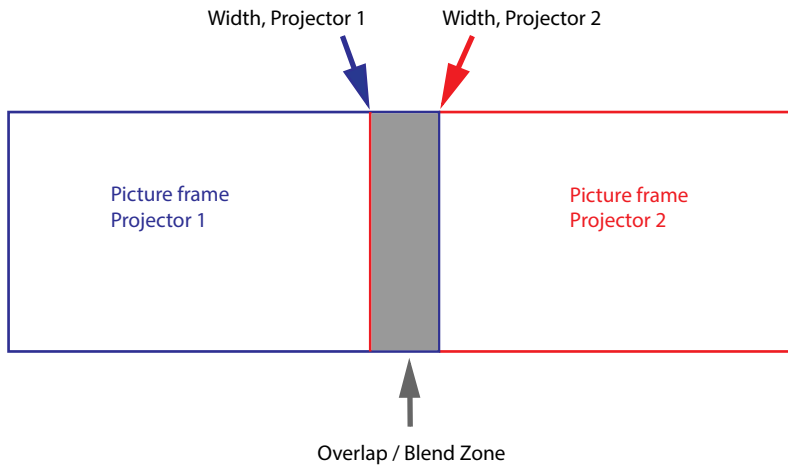

Image 8-48

From the start (mask) position, you can blend zone size per edge (left, top, right, bottom). For each edge there will be a drop-off curve for the blend zone.

### Overview

- Blend & Mask
- Blend Files
- Basic black level adjustment
- Black Level Files
- RGB adjustment

## 8.8.1 Blend & Mask

### About masking and blending width or height

Offset is used to clip the image on one or multiple sides (masking). This is used to hide parts of the picture that should not be shown on the screen. For example: if the source is a Windows PC, you can hide the menu bar using this method.

The larger the Mask value, the more the image is masked (by black bar) at the corresponding side. E.g. Top mask of 100 will blank the top 100 lines.

Height or width is used to create a blending zone with a smooth brightness drop off. This is used to compensate for the double brightness in overlap areas. The value is the size of the blended area in pixels.

### How to adjust blend zones?

1. In the main menu, select *Installation* → *Blend and Mask* → *Blend – Mask*.

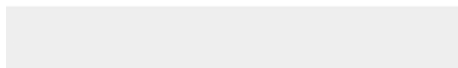

Image 8-49: Blend and Mask menu, Blend – Mask

The Blend – Mask menu is displayed.

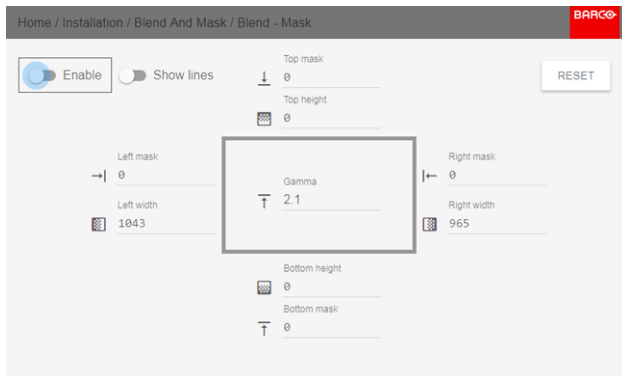

Image 8-50: Blend & Mask menu

2. To enable blending, put the **Enable** switch to the right. The color of the switch becomes blue when enabled.
3. To project masking lines on the screen, put the **Show lines** switch to the right. The color of the switch becomes blue when enabled.
4. Determine the start position of the mask (1) for the masking height and width, together with the desired size of the mask (2) to determine the width of the masked area.

When the blending lines are activated, you will get a visual indication of the screen of the installed blending area.

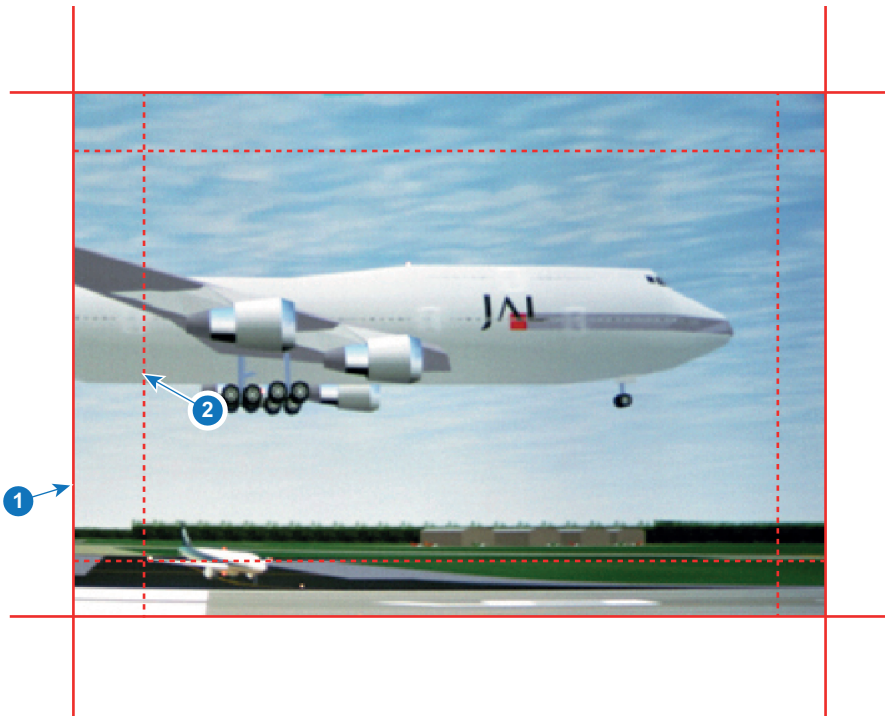

Image 8-51

- 1 Start position (mask)
- 2 Blending width

5. Select one of the four starting positions values with the arrow keys and confirm.
6. Use the arrow keys or remote digits to change the value of the mask and confirm.
7. Repeat this process for the desired width/height value.
8. Repeat this process for all other desired sides.



Do not forget to disable the **Show lines** button after you achieved the desired blend zone.

### Example of the use of blending

When projecting an image with 2 or more projectors, there is always an small overlap that should be corrected by using the blending function.



In order to obtain a satisfying result for the Blend function, the overlap / mask zone are recommended to be at least 10% of the picture width.

The basic principle is that the overlap setup in the source shall correspond with the mask width setup for the projector. That means that if the overlap zone for the source is set to 500 pixels, the width of the mask zone for the projector also must be set to 500 pixels.

First step is to align the image from the projectors as accurate as possible in a mechanical way, meaning without any optical corrections. At the same time, establish an overlap in the pictures between the two screens.

Then adjust the remaining irregularities by using the shift and warp features in the projectors to obtain the last fine tuning of the alignment.

Enable blending and activate Show lines.

First set the mask width for the right edge of the first projector. Enter a width value equal to the overlap area (width1).

Repeat for the left edge of the second projector.

Adjust the offset to cut the image on each side (masking).

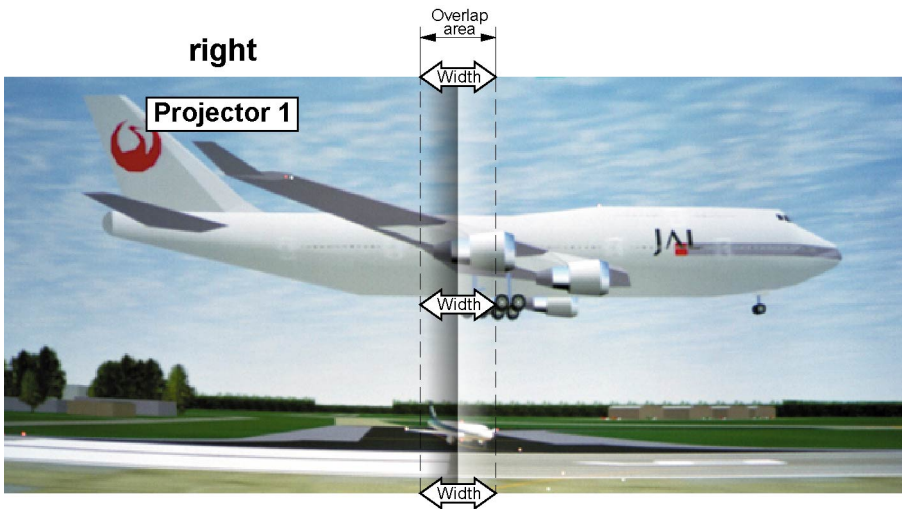

Image 8-52: Set up for projector 1

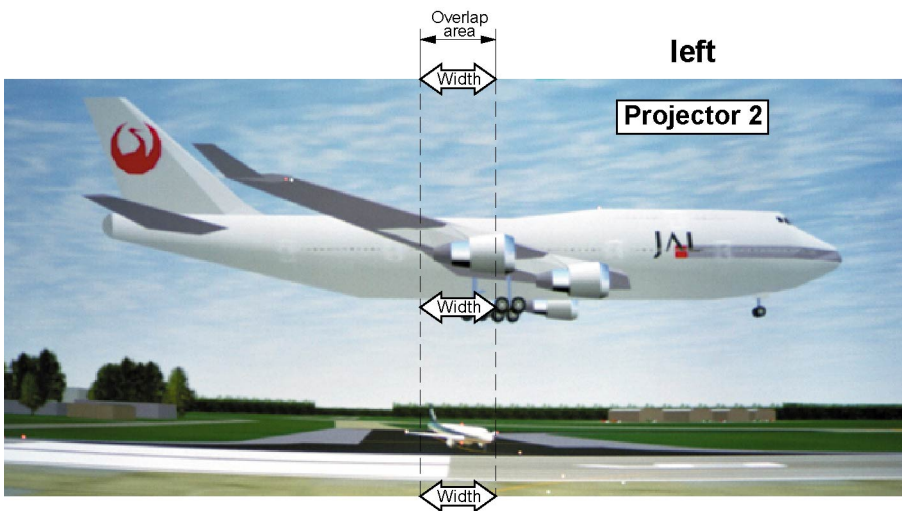

Image 8-53: Set up for projector 2



## 8.8.2 Blend Files

### About custom Blend Files

Next to setting your specific Blending configuration in the GUI, you can also upload or download a custom Blend configuration file in png, jpg or tiff format to/from the projector. This is a timesaving option when multiple projectors need an identical blending configuration.

To upload or download Blend configuration files you can use Projector Toolset or upload/download the Blend configuration file in the format of an xml file. Alternatively, you can contact the “file endpoint” directly via the curl program or some other tool that supports http upload.

For more information on uploading/downloading Blend files using the Projector Toolset, refer to the Projector Toolset user manual.

For more information on uploading/downloading Blend files using curl or other tools that supports HTTP upload, refer to the Pulse API Reference Guide.

### How to activate an uploaded Blend configuration file?

1. In the main menu, select *Installation* → *Blend and Mask* → *Blend Files*.



Image 8-54: Blend and Mask menu, Blend Files

The Blend Files menu is displayed.

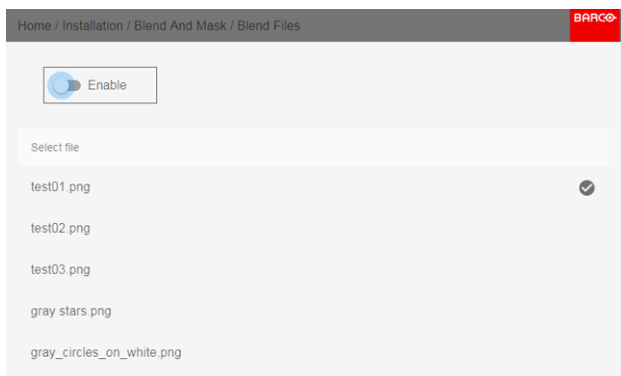

Image 8-55

2. If any custom Blend files are available, select the desired file.

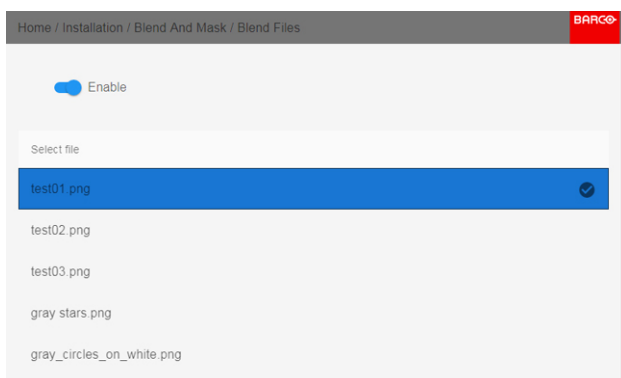

Image 8-56

3. Click on the *Enable* slider on top to activate the selected Blend file.

## 8.8.3 Basic black level adjustment

### About adjusting the black level

The purpose of the black level adjustment is to align the black levels in the overlapped regions with the black levels in the other regions.

This is needed because the black levels will be brighter in the blend zones, since multiple projectors will project on the same screen area.

The size of the black level area is calculated automatically from the blend zones. This is done by using the start position and size of each edge of the blend and adding an additional size of 8 pixels to reduce the effect known as "sea of mirrors".

You can also specify the offsets manually by turning off the automatic calculation. The black level value is adjusted in a 16-bit resolution from 0 to 65535.

The following figure shows how this occurs in a side by side configuration without any correction of the black level.



Image 8-57

### How to adjust the black level manually

1. In the main menu, select *Installation* → *Blend and Mask* → *Black Level* → *Basic Black Level*.

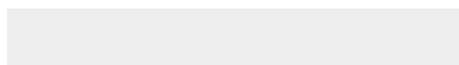

Image 8-58: Black Level menu — Basic Black Level

The Basic black level menu is displayed.

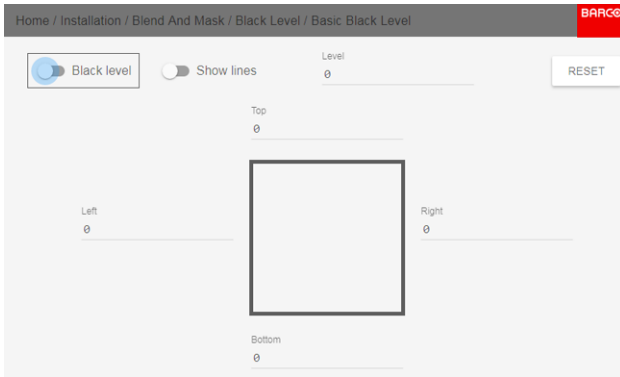



Image 8-59: Basic Black Level menu

2. Enable the **Black level** button. If you want a visual aid, enable the **Show lines** button as well.
  3. Move the cursor to the side where the overlapped area occurs (left/right/top/bottom) and press enter.
  4. Adjust the level with the arrow keys and press enter when the desired black level zone is reached.
- or
- enter the black level value with the numeric keys in the remote control.
5. Move the cursor to “Level”, press enter and adjust this level until the black level equals the level in the blend zone.  
This value can also be entered by the numeric keys on the remote control.
  6. Repeat the same procedure for any other projector connected to this projector, but on the opposite side.

 **Note:** Do not forget to disable the **Show lines** button after you achieved the desired blend zone.

## 8.8.4 Black Level Files

### About custom Black Level Files

Next to setting your specific Black Level Adjustment in the GUI, you can also upload or download a custom Black Level adjustment file in png, jpeg or tiff format to/from the projector.

To upload or download Black Level adjustment files you can use Projector Toolset or upload/download the Black Level adjustment file in the format of an XML file. Alternatively, you can contact the “file endpoint” directly via the curl program or some other tool that supports http upload.

For more information on uploading/downloading Black Level files using the Projector Toolset, refer to the Projector Toolset user manual.

For more information on uploading/downloading Black Level files using curl or other tools that supports HTTP upload, refer to the Pulse API Reference Guide.

### How to activate an uploaded Black Level adjustment file?

1. In the main menu, select *Installation* → *Blend and Mask* → *Black Level* → *Black Level Files*.

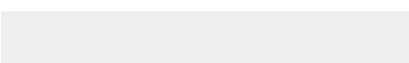

Image 8-60: Black Level menu, Black Level Files

The Black Level Files menu is displayed.

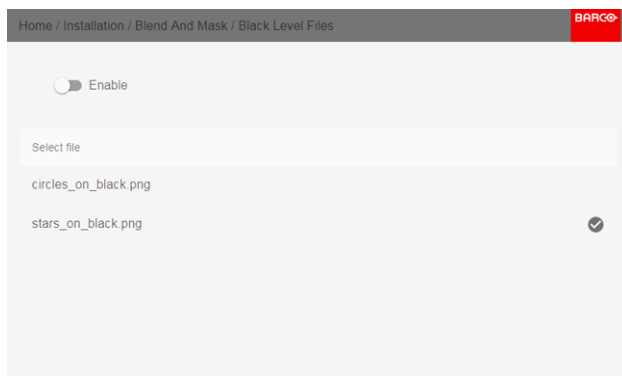

Image 8-61

2. If any custom Black Level adjustment files are available, select the desired file.

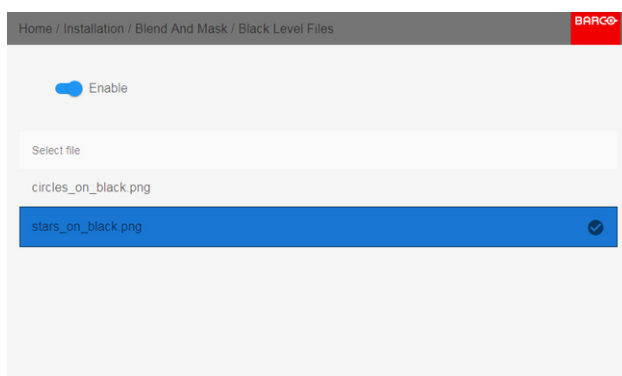

Image 8-62

3. Click on the *Enable* slider on top to activate the selected Black Level adjustment file.

## 8.8.5 RGB adjustment

### About RGB adjustment

The purpose of black level correction is to ensure a uniform black level in multi projector setups. Even when two projectors are of the same type, different projectors will output slightly different colors for black due to minor variations in their optical components. So if the projected image of the projectors overlap, there will be 3 different black levels: one for the zone where only the picture of the left projector (zone 1), one for the Blend zone (zone 2), and one for the zone where there is only the picture of the right projector (zone 3).



Image 8-63

The black levels for zone 1 and zone 3 are typically corrected by defining a black level mask, which is applied to the image of each projector. This system is already in place but the applied mask is monochrome.

Using the Basic Black Level menu, you can already specify the area of the mask and its contents. But by using the RGB Adjustment page, you can specify the multiplication factors (gains) for the Red, Green and Blue colors separately.

### How to perform an RGB adjustment

1. In the main menu, select *Installation* → *Blend and Mask* → *Black Level* → *RGB Adjustment*.

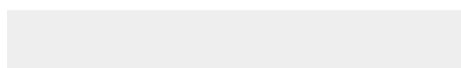

Image 8-64: Black Level menu, RGB Adjustment

The RGB Adjustment menu is displayed.

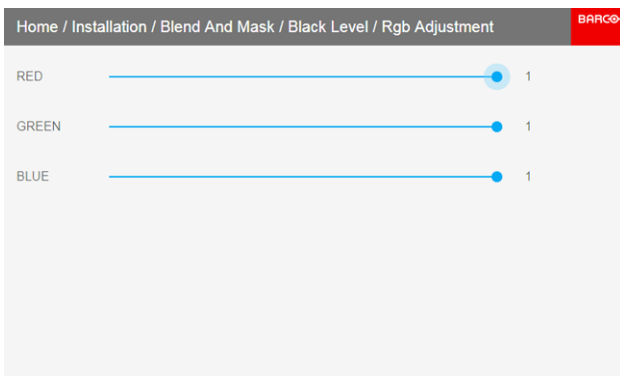

Image 8-65: RGB Adjustment menu

2. Select one of the three sliders.
3. Use the left and right arrow keys to modify the gain of the chosen color.
4. Repeat for every slider until the desired result is achieved on screen.

## 8.9 Laser illumination

### What can be done?

Within a certain percentage, the light output of the light source can be reduced by reducing the laser power.

Alternatively, you can enable CLO mode (Constant light output) for a constant light output over a longer period of time.



You can only change the power output when the shutter is opened.

### About CLO mode

All light sources naturally decrease their intensity over time. In order to prevent a decreasing output in a multi-projector setup, you can activate CLO mode to make sure that the light output remains constant.

CLO mode will ensure that the projector regulates its illumination power to maintain the same level of output light during the lifetime of the light source. This requires that the light source power is not set to 100% from the start, but to a lower value. The lower this value is set, the longer the projector will be able to maintain the output level.

### How to reduce the power

1. In the main menu, select *Installation* → *Illumination* → *Power*.

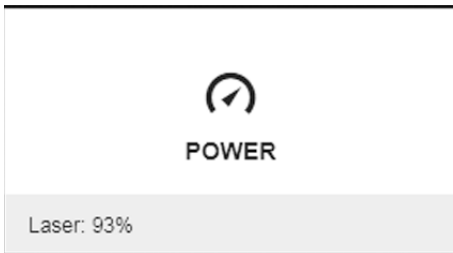

Image 8-66: Illumination menu, Power

The actual power setting is indicated at the bottom of the *Power* button.

2. Use the Slider to change the power value.

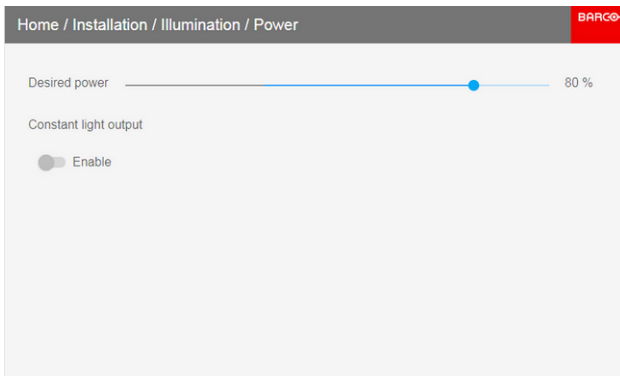

Image 8-67

3. If you want CLO mode to be active, click **Enable** underneath *Constant light output*.



## 8.10 Setting up the external cooler

### Using the external cooler

When the external cooler for the UDX projector is installed, the Cooling menu will be enabled and visible in the menu. For more info on installing the external cooler, refer to the installation manual of the UDX.

Using the Cooling menu, you can choose between the following cooling methods:

- **Internal:** Use only the internal cooling system of the UDX (default).
- **External:** Use only the external cooling system of the UDX. This method is preferred when the cooler is in a different location than the projector and you want the projector to operate in “silent mode”.
- **Mixed:** Use both the external and internal cooling. Can be used to extend the lifetime of the internal cooler

### How to set up the external cooler

1. In the main menu, select *Installation* → *Illumination* → *Cooling*.



Image 8-68: Illumination menu, Cooling

The Cooling menu is shown.

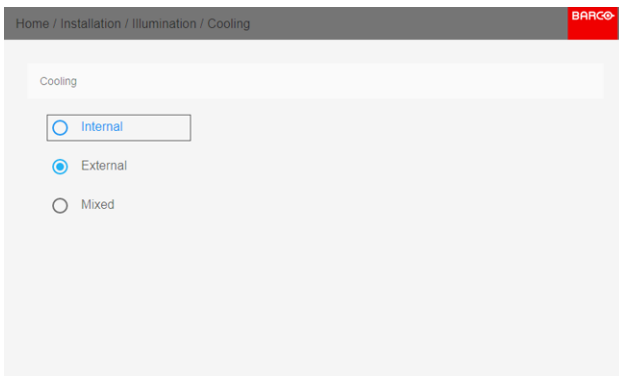

Image 8-69: Cooling menu

2. In the Cooling menu, select the desired cooling option.

## 8.11 Scaling modes

### About scaling modes

While the default mode of projection is to fill the screen while respecting the aspect ratio (fill aspect), it is also possible to stretch the image in a different way. You can choose from one of the following scaling methods:

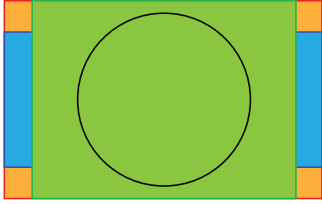
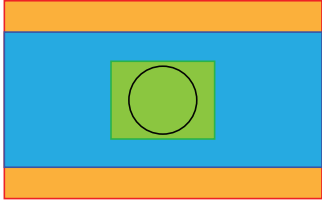
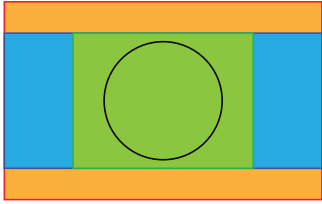
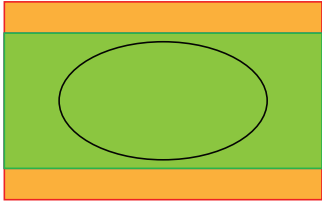
Scaling Mode	Explanation	Example image <sup>6</sup>
Fill aspect	<b>Default scaling mode.</b> Stretches the image to the native resolution of the DMD, while respecting the original aspect ratio.	
1:1	An exact rendering of the source signal, which may be smaller than the native resolution	
Fill screen	Fills the screen to the screen size defined in the Screen Size menu, while respecting the original aspect ratio. For more info on adjusting the Screen Size menu, see “Warping – Screen Size”, page 112.	
Stretch	This mode stretches the image to the screen size defined in the Screen Size menu, while ignoring the original aspect ratio. For more info on adjusting the Screen Size menu, see “Warping – Screen Size”, page 112.	

### Setting a scaling mode

1. In the main menu, select *Installation* → *Scaling*.



Image 8-70: Installation menu, Scaling

The Scaling menu is displayed.

<sup>6</sup>: Example using a screen of 2,35:1, an input signal of 4:3 and a projector with a native resolution of 3840 x 2400

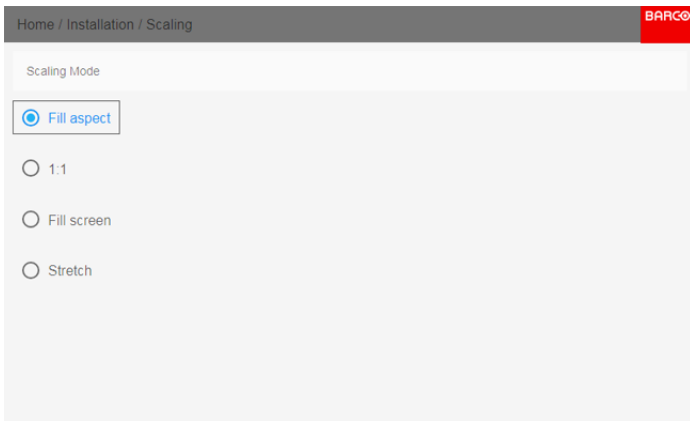

Image 8-71: Scaling Menu

2. In the Scaling menu, select the desired scaling mode and confirm.

## 8.12 3D projection

### 3D setup

The projector is capable of displaying 3D images and movies in active stereoscopic 3D.

Setup of a 3D installation requires an advanced understanding of 3D systems, both for the projector as well as for the system the signal source originates from. In a 3D setup it is crucial that the projected images are perfectly synchronized through the whole signal path, from the signal source to the picture viewed through the 3D goggles.

Regarding setting up the proper signal source, please refer to the user manual or online help for that graphic card. For example: when using NVIDIA Quadro cards, use the NVIDIA Control Panel to manage your 3D settings.

### Overview

- Active Stereo & Passive Stereo
- Setup process 3D projection
- Connection possibilities
- Choosing the desired Display Setup
- 3D emitter Setup

## 8.12.1 Active Stereo & Passive Stereo

### What is Passive Stereo?

Passive Stereoscopic 3D (also known as “Passive Stereo”) is the standard method of creating the illusion of depth in an image, by means of stereopsis for binocular vision.

To present stereoscopic pictures, two images are projected superimposed onto the same screen through polarizing filters or presented on a display with polarized filters. For Digital Cinema, a silver screen is used so that polarization is preserved. On most passive displays every other row of pixels are polarized for one eye or the other. This method is also known as interlacing.

The viewer wears glasses which contain a pair of opposite polarizing filters. As each filter only passes light which is similarly polarized and blocks the opposite polarized light, each eye only sees one of the images, and the effect is achieved.

### What is Active Stereo?

Field sequential 3D (also known as active 3D or “Active Stereo”) is a technique of displaying stereoscopic 3D images. It works by only presenting the image intended for the left eye while blocking the right eye's view, then presenting the right-eye image while blocking the left eye, and repeating this so rapidly that the interruptions do not interfere with the perceived fusion of the two images into a single 3D image.

This system setup uses liquid crystal shutter glasses (also known as active shutter glasses). Each eye's glass contains a liquid crystal layer which has the property of becoming opaque when voltage is applied, being otherwise transparent. The glasses are controlled by a timing signal that allows the glasses to alternately block one eye, and then the other, in synchronization with the refresh rate of the screen. The timing synchronization to the video equipment may be achieved via a wired signal or via wireless communication, this by using either an infrared or radio frequency (e.g. Bluetooth, DLP link) transmitter.

### Projection method used

This projector can only show active 3D images, used in combination with a 3D emitter and active shutter glasses. While it is allowed to connect passive stereo source signals, the image processing of the projector will convert those signals to an active 3D compatible image.

The options on the projector software allow you to fine-tune the 3D settings accordingly to the specifications of the 3D emitter.



If a 3D emitter is used that radiates IR beams, the IR beams may interfere with the IR communication between projector and the RCU. If such interference occurs, connect the RCU to the projector using the remote cable. It is also advised to turn the IR receivers on the projector off to avoid the 3D emitter interference. To turn off the IR receivers, see “Remote control, on/off button”, page 27.

## 8.12.2 Setup process 3D projection

### How to setup 3D projection?

1. Connect the proper source cables to the projector. For more info, see “Connection possibilities”, page 143.
2. Set up and connect your 3D emitter to the projector. For more info, refer to the user manual of your 3D emitter.
3. Power on the projector completely.
4. Select the correct stitched source Input in the Source menu. See “Displaying multiple sources: Stitched layouts”, page 83.
5. Select the desired Display format. For more info, see “Choosing the desired Display Setup”, page 144.
6. Depending on the chosen 3D emitter, correct the 3D setup. For more info, see “3D emitter Setup”, page 146.

### 8.12.3 Connection possibilities



At this moment, the only inputs supporting 3D on the Pulse input boards are the DisplayPort inputs and HDMI input. More inputs may support 3D in a future release.

#### Connecting with the quad combo input card

There is only one way of projecting Active stereoscopic 3D with the Combo input card, using the following setup:

- **Source:** Active Stereo (sequential L/R)
- **Layout mode:** Standard layout (1x1 layout)
- **Video Timing:** 2560 x 1600 (WQXGA) @120 Hz
- **Color depth:** 30 bpp
- **Connector:** DisplayPort 1.2 or HDMI

#### Connecting with the quad DP 1.2 Input card

You can use one of the following methods. The resulting image will always be an Active Stereo image.

Source	Layout mode	Video Timing / cable	Fixed configuration?	Color depth
Active Stereo (sequential L/R)	Standard layout (1x1 layout)	2560 x 1600 @120 Hz		30 bpp
Active Stereo (sequential L/R)	4 Column mode (4x1 layout)	960 x 2160 @120 Hz		30 bpp
Active Stereo (sequential L/R)	4 Quadrant mode (2x2 layout)	1920 x 1080 @120 Hz		30 bpp
Passive Stereo (separate L/R)	Standard layout (1x1 layout)	3840 x 2160 @60 Hz	<ul style="list-style-type: none"> <li>• Cable 1: left eye</li> <li>• Cable 2: right eye</li> </ul>	30 bpp
Passive Stereo (dual pipe L/R)	2 Column mode (2x1 layout)	1920 x 2160 @60 Hz	<ul style="list-style-type: none"> <li>• Cable 1: left eye, left column</li> <li>• Cable 2: left eye, right column</li> <li>• Cable 3: right eye, left column</li> <li>• Cable 4: right eye, right column</li> </ul>	30 bpp

## 8.12.4 Choosing the desired Display Setup

### Output modes

The following output modes are available:

- **AutoStereo**: Automatic mode (2D input = 2D output, 3D input = Active Stereo output).
- **Mono**: Forces all source signals to 2D output.
- **ActiveStereo**: Forces all source signals to Active Stereoscopic 3D.

Use the following table as an indicator of what display mode you require.

Source signal	AutoStereo	Mono	ActiveStereo
2D Source	Output is a 2D image	Output is a 2D image	Output is in Active Stereo
Active Stereo source	Output is in Active Stereo	Output is a 2D image	Output is in Active Stereo
Passive Stereo source	Output is in Active Stereo	Output is a 2D image	Output is in Active Stereo



When a different Display Mode is chosen compared to the source signal (e.g. Active Stereo source with Mono output), advanced image processing will make sure you a desirable image will be displayed.

### How to select the desired projection method?

1. In the main menu, select *Installation* → *Display Setup*.

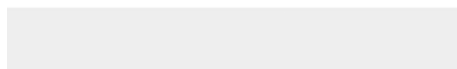

Image 8-72: Installation menu, Display setup

The Display setup menu is displayed.



Image 8-73: Display setup menu

2. Select the desired Display Mode:
  - AutoStereo (default value)
  - Mono
  - ActiveStereo



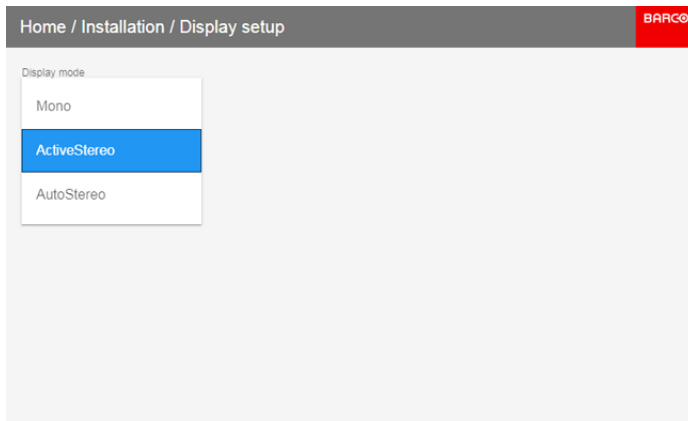

Image 8-74: Display Setup menu options

## 8.12.5 3D emitter Setup

### Why change the 3D setup?

While Barco can provide a 3D emitter and active shutter glasses as options to this projector, you are also free to use a 3D emitter and active shutter glasses of your own choice. Since glasses and emitter can have various specifications compared to the ones Barco can provide, the 3D setup menu allows you to configure the output image to the specifications of your glasses and emitter. The following can be configured:

- **Swap Eye:** You can choose to invert the stereo Sync output signal ( depending on the chosen 3D emitter and glasses).
- **Swap frame pair:** This setting allows you to correct the frame doubling sequence. If the frame rate of the projected moving 3D content doesn't look smooth, this option may help improve this.
- **Dark time:** You can select how much dark time the projected image will have between frames. You can choose one of the options between 1000  $\mu$ s and 2500  $\mu$ s.
- **Sync Delay:** You can increase or decrease the sync delay. The scale goes from -10 000  $\mu$ s to +10 000  $\mu$ s with a step of 100  $\mu$ s.



If a 3D emitter is used that radiates infrared beams (IR beams), the IR beams may interfere with the IR communication between projector and the RCU. If such interference occurs, connect the RCU to the projector using the remote cable. It is also advised to turn the IR receivers on the projector off to avoid the 3D emitter interference. To turn off the IR receivers, see "Remote control, on/off button", page 27.

### How to adjust the projector to the 3D emitter?

1. In the main menu, select *Installation* → *3D Setup*.



Image 8-75: Installation menu, 3D setup

The 3D setup menu is displayed

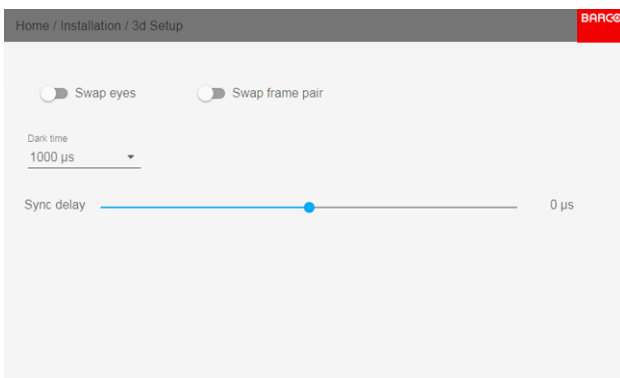

Image 8-76: 3D setup menu

2. Select the desired the stereo *Dark Time*.
3. Use the slider to set the desired stereo *Sync delay*.
4. If it is necessary to invert the stereo sync output, enable the *Swap eyes* option.
5. If the projected moving 3D content doesn't look smooth enough, enable the *Swap frame pair* option to help improve this.

# GUI – Macro's and projector profiles

# 9

## About macro's and projector profiles

Projectors can have different settings, depending on different environments (e.g. playing video games in a bright environment or playing a movie in a dark environment), or using different mediums (e.g. content from an old DVD versus an HDR-coded blu-ray). Using profiles you can now save the projector settings for each situation, making it easier to load these settings back up when entering a frequently recurring setup.

## Overview

- Saving the current projector settings in a profile
- Assigning a created projector profile to a preset
- Deleting a projector profile

## 9.1 Saving the current projector settings in a profile

### Which settings can be saved to a profile?

Profile setting name	Settings saved
Source	Active source selection
Image	<ul style="list-style-type: none"> <li>• All basic image settings: contrast, brightness, saturations, sharpness &amp; gamma</li> <li>• Used gamma type</li> <li>• Digital Zoom (width / height / factor)</li> <li>• Digital shift (x/y)</li> <li>• Output resolution</li> </ul>
PQ	Screen luminance & HDR boost value
P7 Realcolor	Color mode & coordinates
Installation	<ul style="list-style-type: none"> <li>• Lens parameters (lens zoom, focus &amp; shift)</li> <li>• Position of motorized frame (if used).</li> <li>• Shutter status (open or closed).</li> <li>• Orientation (mounting &amp; projection)</li> <li>• Scaling mode</li> </ul>
Warp	<ul style="list-style-type: none"> <li>• Warp status enabled / disabled</li> <li>• Screen size</li> <li>• Warp file selected</li> <li>• Transport Delay</li> </ul> <p><b>Note:</b> Bow and 4Corners warp cannot be saved.</p>
Blend	<ul style="list-style-type: none"> <li>• Blend mask enabled / disabled</li> <li>• All Masks (top / bottom / left / right) and heights (top / bottom / left / right)</li> <li>• Blend files enabled / disabled</li> <li>• Blend file selected</li> </ul>
Black level	<ul style="list-style-type: none"> <li>• Black level file enabled / disabled</li> <li>• Black Level file selected</li> <li>• Basic black level enabled / disabled</li> <li>• Black level settings (top / bottom / left / right)</li> </ul>
RGB Adjustment	Red, Green and Blue values
Illumination	<ul style="list-style-type: none"> <li>• Power setting</li> <li>• CLO enabled / disabled</li> <li>• CLO set point</li> </ul>
Cooling <sup>7</sup>	Selected Cooling mode
3D setup	<ul style="list-style-type: none"> <li>• Display mode used</li> <li>• Swap eyes on / off</li> <li>• Swap frame pair on / off</li> <li>• Dark time and sync delay values</li> </ul>

### How to save the current projector profile to a macro?

1. In the main menu, select *Profiles* → *New*.

<sup>7</sup>: Only if external cooler is installed



Image 9-1: Profile menu, new

The New Profile menu is displayed.

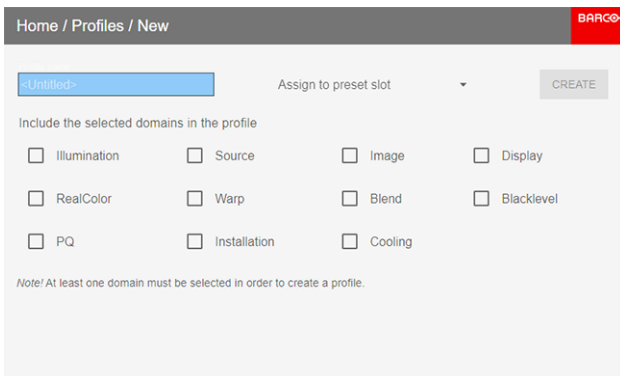

Image 9-2: New Profile menu

2. Press the Okay key in the top-left field to display a keyboard. Use the keyboard to enter a valid macro name. Confirm with the enter key once completed.
3. You can assign this macro to one of the available *preset slots*, by selecting a preset slot using the arrow keys. Confirm your selection.
4. Use the arrow keys the okay key to select any of the settings you wish to save in this macro.
5. Save your macro by pressing *Create*.

## 9.2 Assigning a created projector profile to a preset

### How to assign a projector profile to a preset

1. In the main menu, select *Profiles* → *Edit*.



Image 9-3: Profiles Menu, Edit

The edit menu is displayed.

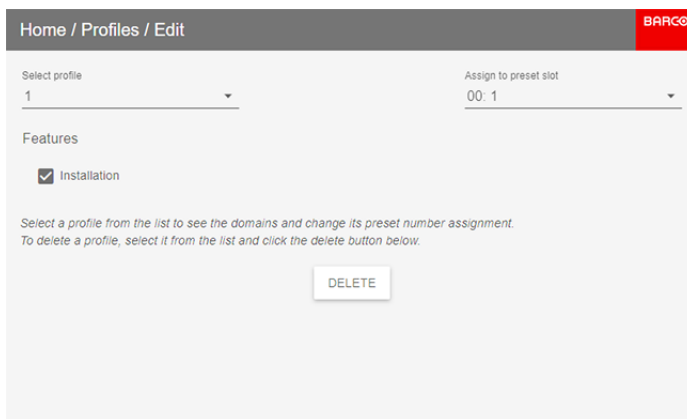

Image 9-4: Edit macro menu

2. Select the desired projector profile from the dropdown list.  
The details of the projector profile are displayed.

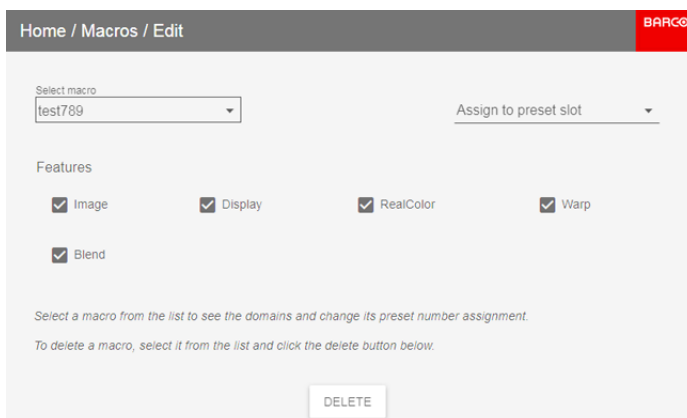

Image 9-5: Details of the profile

3. Use the arrow keys to select a preset slot and confirm with the okay key.



Image 9-6: Preset

## 9.3 Deleting a projector profile

### How to delete a profile

1. In the main menu, select *Profiles* → *Edit*.



Image 9-7: Profile Menu, Edit

The edit menu is displayed.

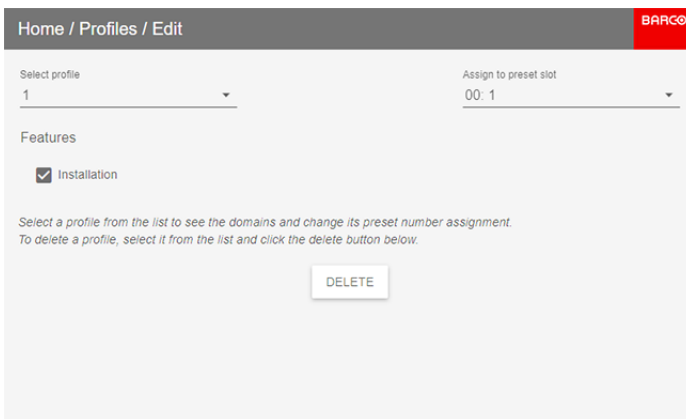

Image 9-8: Edit Profile menu

2. If not immediately visible, select the undesired profile from the dropdown list.

The details of the profile are displayed.

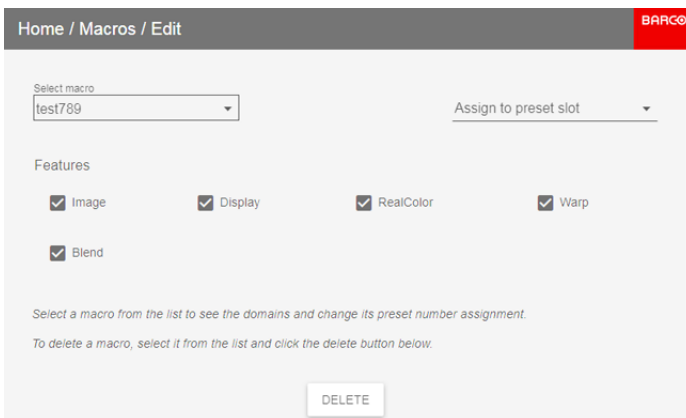

Image 9-9: Details of the macro

3. Press *Delete* and confirm your action.



# GUI – System Settings

# 10

## Overview of features

- Communication, LAN setup
- IR control
- Setting a custom projector name
- DMX
- Front XLR output voltage control
- GSM configuration
- Themes
- Setting the measurement system
- Disabling Standby mode
- Lens features
- Controlling the backlight of the LCD Display
- Reset
- Lens Calibration
- Flex brightness
- Rigging frame Calibration
- Electronic Convergence
- Advanced Settings

## 10.1 Communication, LAN setup

### About a network connection

A network connection can be made via a wired connection or via the optional wireless unit.

### Overview

- Introduction to a Network connection
- Wired IP address set up
- Wireless IP address set up

## 10.1.1 Introduction to a Network connection

### DHCP



Dynamic host configuration protocol. DHCP is a communications protocol that lets network administrators manage centrally and automate the assignment of IP addresses in an organization's network. Using the Internet Protocol, each machine that can connect to the Internet needs a unique IP address. When an organization sets up its computer users with a connection to the Internet, an IP address must be assigned to each machine. Without DHCP, the IP address must be entered manually at each computer and, if computers move to another location in another part of the network, a new IP address must be entered. DHCP lets a network administrator supervise and distribute IP addresses from a central point and automatically sends a new IP address when a computer is plugged into a different place in the network.



### IP

Internet Protocol. The network layer of TCP/IP. Required for communication with the internet.



### Subnet mask

A number that is used to identify a subnetwork so that IP addresses can be shared on a local area network.



### Default Gateway

A router that serves as an entry point into and exit point out of a network. For example, a local network (LAN) may need a gateway to connect it to a wide area network (WAN) or to the Internet.



### MAC address

Media Access Control address. Unique hardware number, used in combination with the IP-address to connect to the network (LAN or WAN).

## What should be set up for an Ethernet address?

Two ways can be used to assign an address:

- use the *Automatic* setting so that an automatic address will be assigned.
- Assign manually an IP address, Net-mask (subnet-mask), (default) gateway address.
  - Set the IP-Address field to the desired value. This must NOT be 0.0.0.0 for static IP-Address assignment. The IP address identifies a projector's location on the network in the same way a street address identifies a house on a city block. Just as a street address must identify a unique residence, an IP address must be globally unique and have a uniform format.
  - Set the Subnet-Mask as appropriate for the local subnet.
  - Set the Default-Gateway to the IP-Address of the local router (MUST be on the local subnet!) on the same network as this projector that is used to forward traffic to destinations beyond the local network. This must not be 0.0.0.0. If there is no router on the projector's local subnet then just set this field to any IP-Address on the subnet.

## 10.1.2 Wired IP address set up

### How to automatically set up the IP address

1. In the main menu, select *System Settings* → *Communication* → *LAN*.



10.200.28.177

Image 10-1: Communication menu, LAN

The LAN menu is displayed

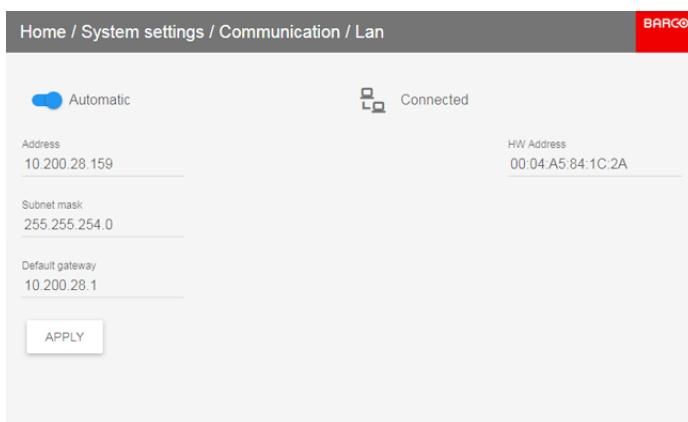

Image 10-2: LAN menu

2. To enable Automatic, put the switch to the right. The color of the switch becomes blue. An automatic IP is assigned. When connected, it is indicated with the connection symbol and the indication *Connected*.
3. Select **APPLY** and click **OK**.

### How to manually set up the IP address

1. In the main menu, select *System Settings* → *Communication* → *LAN*.



10.200.28.177

Image 10-3: Communication menu, LAN

The LAN menu is displayed

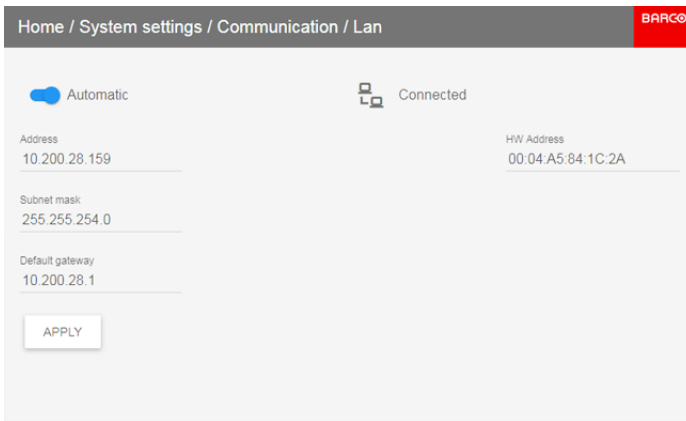

Image 10-4: LAN menu

2. Disable Automatic. Put the switch to the left. The switch becomes gray.
3. Use the ▲ or ▼ key to select *Address* and press **OK** button to activate the input box.
4. Use the ▲ or ▼ key to change the selected character.  
Use the ◀ or ▶ key to select another character.



*Note:* Digits can be entered with the digit keys on the remote control or the local keypad. When a digit is entered in that way, the next character will be selected automatically.

5. Repeat steps 4 and 5 for the Subnet mask and Default Gateway.
6. Select **APPLY** and click **OK** to confirm all changes.

When the connection is established, it is indicated with the connection symbol and the indication *Connected*.

### 10.1.3 Wireless IP address set up

#### When can the wireless IP address be used?

When the optional WiFi module has been installed on the projector, you can configure the projector in such a way it can access the network via WiFi instead of a LAN cable.

For more information on how to install the WiFi module, please refer to the installation manual.

#### How to connect to a wireless network?

1. In the main menu, select *System Settings* → *Communication* → *WiFi*.

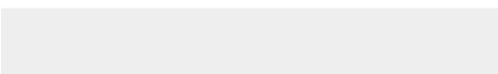

Image 10-5: Communication menu, WiFi

The WiFi menu is displayed.

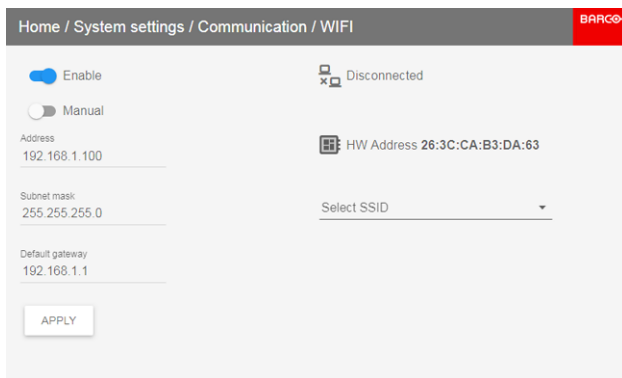

Image 10-6: WiFi menu

2. Put the upper switch to the right to enable the WiFi module. The color of the switch becomes blue.
3. Make sure the second switch is set to the right (automatic).

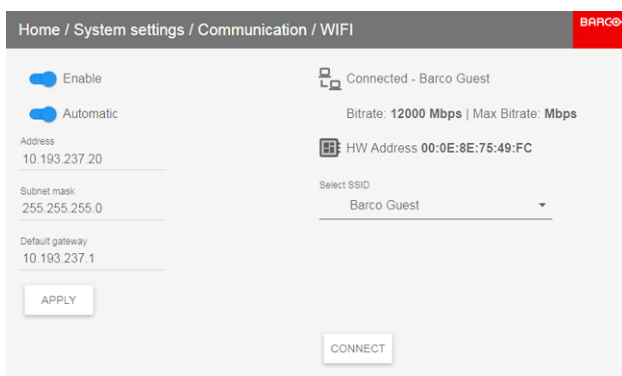

Image 10-7: Automatic assignment

4. Select the *Select SSID* dropdown menu and select the desired wireless network.



*Tip:* If the desired wireless network is not in the list or hidden by default, select “Add New SSID”. Fill in the details of the network.

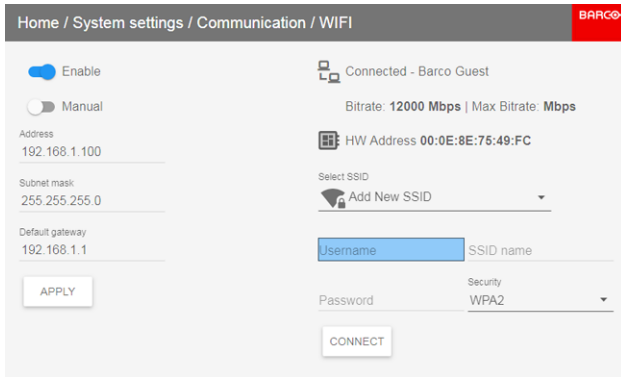

Image 10-8

5. If required by the chosen wireless network, fill in the username and password and confirm.



*Tip:* If you already connected to this network in the past using this projector, the software will remember the username and password, ensuring you do not have to fill this in again.

6. Press *Connect* to connect to the selected network.

An automatic IP address is assigned.

When connected to this network, it is indicated in the upper right corner of the menu with the term “connected”.

### How to manually set up the IP address

1. In the main menu, select *System Settings* → *Communication* → *WiFi*.



Image 10-9: Communication menu, WiFi

The WiFi menu is displayed.

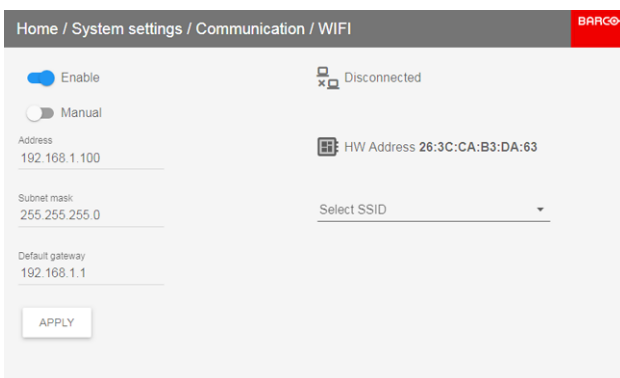

Image 10-10: WiFi menu

2. Disable Automatic. Put the lower switch to the left. The switch becomes gray and the label will read “Manual”.
3. Use the ▲ or ▼ key to select *Address* and press **OK** button to activate the input box.
4. Use the ▲ or ▼ key to change the selected character.  
Use the ◀ or ▶ key to select another character.



*Note:* Digits can be entered with the digit keys on the remote control or the local keypad. When a digit is entered in that way, the next character will be selected automatically.

5. Repeat steps 4 and 5 for the Subnet mask and Default Gateway.
6. Select **APPLY** and click **OK** to confirm all changes.
7. Select the *Select SSID* dropdown menu and select the desired wireless network.
8. Press *Connect* to connect to the selected network.
9. If required by the chosen wireless network, fill in the username and password and confirm.

An automatic IP address is assigned.

When connected to this network, it is indicated in the upper right corner of the menu with the term “connected”.



## 10.2 IR control

### Overview

- Broadcast address
- Projector address
- IR sensors

## 10.2.1 Broadcast address

### About broadcast address

Broadcast address is a common address that can be set on the projector. That can be “0” or “1”. Any command coming from a remote control programmed with that common address will be executed.

### How to the broadcast address

1. In the main menu, select *System Settings* → *Communication* → *IR Control*.



Image 10-11: Communication menu, IR control

The IR control menu is displayed.

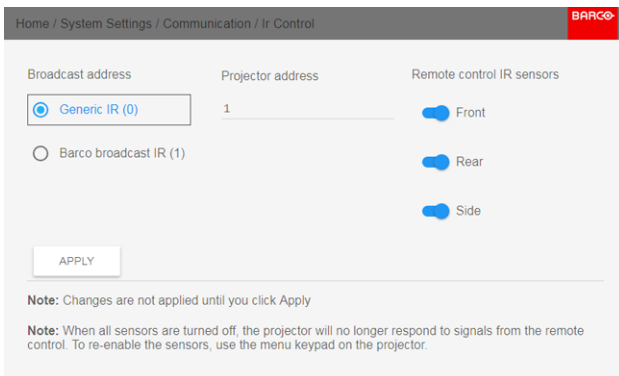

Image 10-12: IR control menu

2. To change the broadcast address select the radio button of your choice.

The following choices are possible:

- Generic IR (address 0)
- Barco broadcast IR (address 1)

3. Select **APPLY** and click **OK** to apply the changes.

## 10.2.2 Projector address

### About individual projector address

Before a projector, and only this projector, can be controlled via a remote control, an individual address must be entered in the projector.

This individual projector address can then be used to control the projector via remote control.

Next to an individual projector address, each projector has also a broadcast address for group control.

### How to change

1. In the main menu, select *System Settings* → *Communication* → *IR Control*.

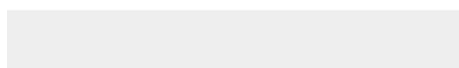

Image 10-13: Communication menu, IR control

The IR control menu is displayed.

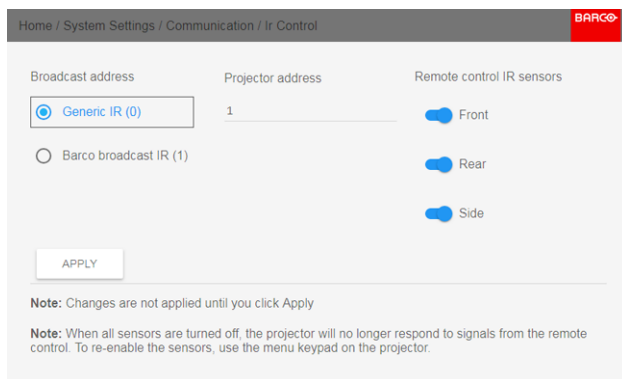

Image 10-14: IR control menu

2. Select the current projector address and enter a new address.
3. Select **APPLY** and click **OK** to apply the changes.

From now on the projector will only listen to this new address and to its broadcast address.

## 10.2.3 IR sensors

### What can be done?

Each IR sensor can be individually disabled or enabled.

When all sensors are turned off, the projector will no longer respond to signals from the remote control. To re-enable the sensors, use the menu keypad on the projector.

### How to disable

1. In the main menu, select *System Settings* → *Communication* → *IR Control*.

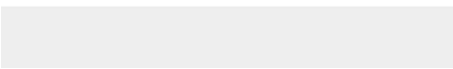

Image 10-15: Communication menu, IR control

The IR control menu is displayed.

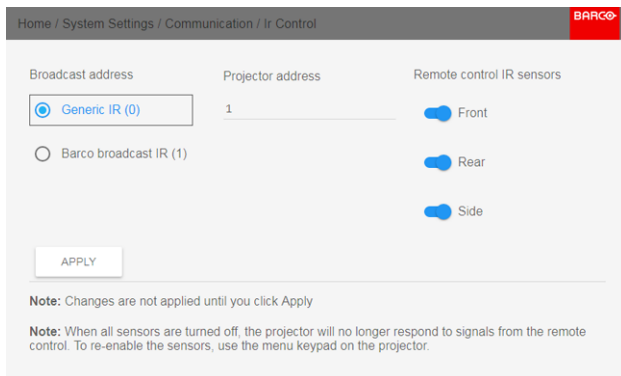

Image 10-16: IR control menu

2. To disable an IR sensor, select the slider and drag to the left.  
A blue slider means an active IR sensor.  
A gray slider means an inactive IR sensor.
3. Select **APPLY** and click **OK** to apply the changes.

## 10.3 Setting a custom projector name

### What can be done?

The default name of the projector is “Pulse”. However, you can change this name to make it easier to spot in a network with multiple devices or projectors

### How to set a different Hostname

1. In the main menu, select *System Settings* → *Communication* → *Hostname*.



Default

Image 10-17: System Settings, Hostname

The Hostname menu is displayed.

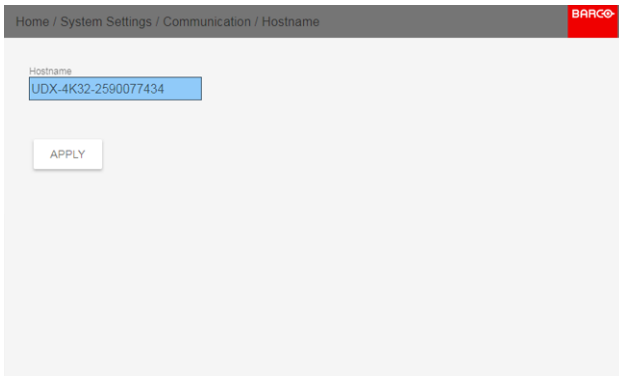

Image 10-18

2. In the Hostname menu, press confirm to edit the Hostname field.
3. Use the digital keyboard to change the Hostname to the desired custom name.

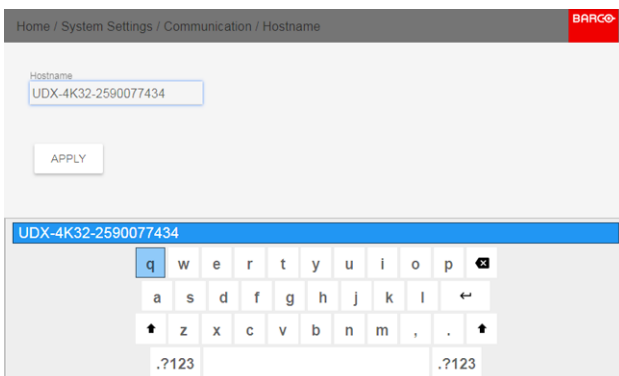

Image 10-19

4. Click *OK* to confirm the typed name and Click *Apply* to update the name.

## 10.4 DMX

### About the ways to control the projector via DMX

DMX signals can be connected to the DMX In port on the communicator interface when using a standard DMX cable equipped with XLR connector. The DMX out can be used to create a chain of DMX devices. One universe can control up to 512 channels.

If you are using a DMX console and other automated lighting products compatible with Art-Net, the Ethernet network can serve as the link for DMX control. All DMX controls can be sent over the Ethernet cable. Multiple universes are possible.

### About the DMX menu

DMX Feature	What can be done?
DMX Address	Before a projector can execute DMX commands, a unique address (named DMX address) should be given to the projector. This address can vary from 1 to 512.
DMX Mode	Two different modes for DMX are available. <ul style="list-style-type: none"> <li>• <b>Basic:</b> A basic configuration where 2 channels are implemented.</li> <li>• <b>Extended:</b> A full configuration, spread over 14 channels.</li> </ul> For the full mapping of each used channel, refer to the DMX chart in the appendices. See “DMX chart”, page 235.
DMX Monitor	If a DMX device is connected, the settings per channel can be displayed via the Monitor button.
Art-Net DMX	DMX can be sent via the Ethernet connector to the projector instead of the classic DMX connector. This function can be enabled or disabled. Art-Net is generally used when more than 512 addresses are used in your setup.
DMX Universe	<b>Note:</b> DMX Universe can only be used when Art-Net DMX is enabled. If Art-Net is enabled, you can specify which DMX universe this projector belongs to.
DMX auto power down	The projector can be forced to shut down after a certain time-out period (in minutes) if no DMX signals are available.
Front XLR connector	If available, the power of the XLR connector on the front side of the projector can be enabled and set to a desired value.

### How to set up DMX?

1. In the main menu, select *System Settings* → *Communication* → *DMX*.



Image 10-20: Communication menu, DMX

The DMX menu is displayed.

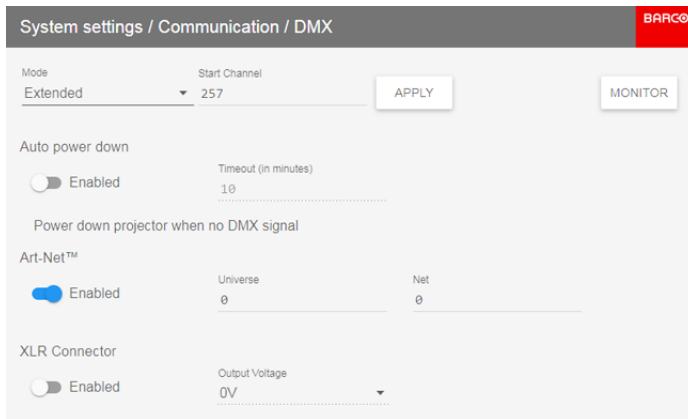

Image 10-21: DMX menu

2. Choose the desired DMX mode.
3. Choose the desired starting channel.
4. Choose whether or not you want the Auto power-down feature to be enabled. If enabled, determine the time-out.
5. If required, enable Art-Net. If enabled, determine the desired Art-Net Universe and Art-Net channel.
6. If a front XLR connector is available on your projector, you can enable the output voltage on this connector.

## 10.5 Front XLR output voltage control

### What can be done?

The output voltage on the front XLR connector can be enabled or disabled. If enabled, the output voltage level can be set to 0 V, 12 V or 24V.

The output voltage depends on the application or peripheral used. For example, the optional external mechanical shutter requires 12 V. The motorized rigging frame on the other end requires 24 V.

DMX Art-Net can also enable the output voltage on the front XLR connector. To avoid that per accident a voltage is activated via DMX Art-Net, set the power level to 0 V.

### Location of the XLR connector

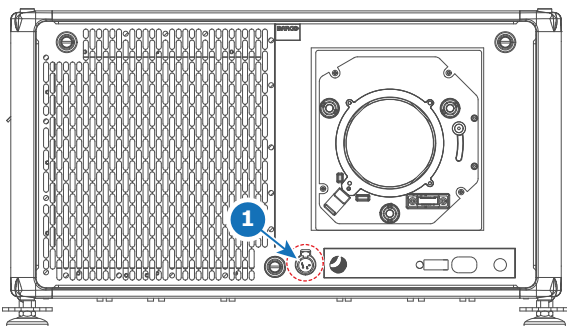

Image 10-22: Location of the XLR connector on the UDX

### How to enable or disable?

1. In the main menu, select *System Settings* → *Communication* → *DMX*.



Image 10-23: Communication menu, DMX

The DMX menu is displayed.

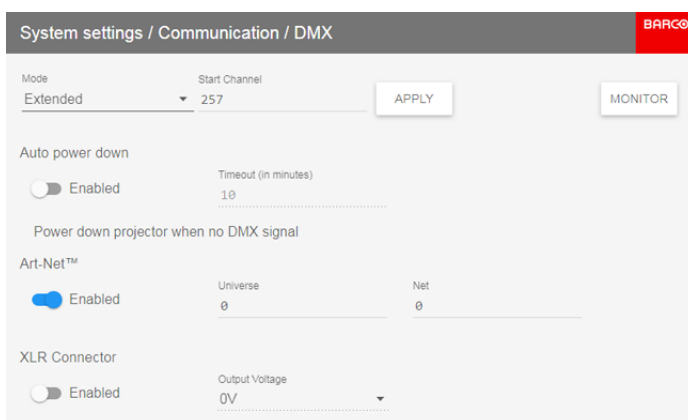

Image 10-24: DMX menu

2. On the bottom of the DMX menu, **Enable** the *XLR connector*.
3. Select the desired *Output Voltage*.



## 10.6 GSM configuration



Only possible when a GSM module with SIM card is installed in the projector.

### What can be done ?

To configure the projector software with the installed SIM card, a correct PIN code (4digits) must be entered.



As the PIN code cannot be checked with the one on the SIM card, ensure to enter the correct PIN code.



When your SIM card is blocked, you have to remove the SIM card from the GSM module and to insert the SIM card in a mobile phone so that you can enter the PUK code to unblock the SIM card.

### How to activate

1. In the main menu, select *System Settings* → *Communication* → *GSM*.



GSM

Image 10-25: Communication menu, GSM

The GSM pin code input menu is displayed. The current configured PIN code is indicated next to Pin input field. If the code is still the same, it is not necessary to enter the PIN code again. If it is a PIN code, continue with next step.



Image 10-26: Enter PIN code

2. Enter the 4 digits of the pin code and select **APPLY** and click **OK**.

## 10.7 Themes

### About Themes

Themes are used to apply a predefined functionality to the OSD display. There are two options: light or dark (default).



While the default theme is dark, all images in this manual are taken while using the light theme.

### How to select a different interface theme

1. In the main menu, select *System Settings* → *Themes*.

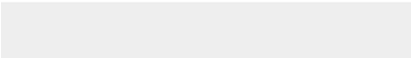

Image 10-27: System Settings Menu — Themes.

2. In the themes menu, select the desired *Theme*.  
You can choose one of the following: *Light*, or *Dark*.

## 10.8 Setting the measurement system

### About the measurement systems

You can use this menu to change the default measurement systems. By default the metric system is used. But you can choose between the following:

- Temperature: °C or °F
- Distance: meter, centimeter, feet or inch.

### How to set a different metric system

1. In the main menu, select *System Settings* → *Units*.



Image 10-28: System settings menu – Units

The Units menu is displayed.

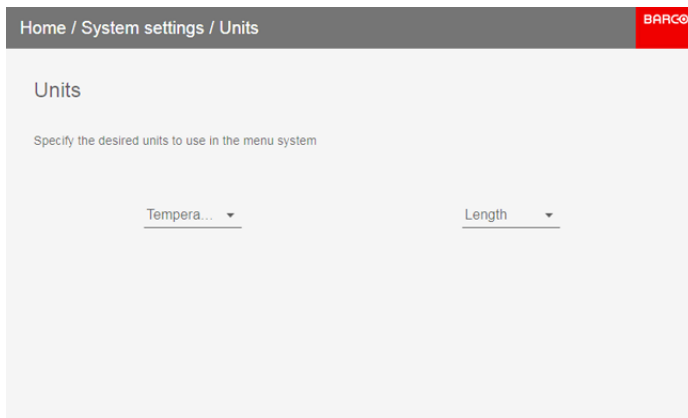

Image 10-29: Units menu

2. Set the desired *Temperature* unit and *Length* unit.

## 10.9 Disabling Standby mode

### When to disable standby mode

Until recently, it was not possible to navigate through the on-screen display (OSD) of the projector while in Ready mode. This feature has been implemented from software version 1.7 onward.

However, by default the projector will automatically go to standby mode after 15 minutes as a power-saving functionality. While in Standby mode, it is no longer possible to use the OSD for anything other than a status overview. In order to prevent the projector from transitioning to this power-saving mode, you can now disable Standby mode.

### How to disable/enable standby mode

1. In the main menu, select *System Settings*.
2. In the System Settings menu, select if you want to enable or disable Standby mode by using the slider underneath *Standby*.

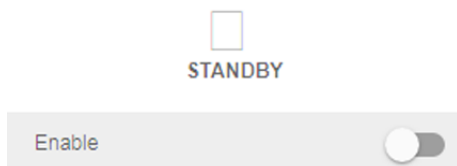

Image 10-30: System Settings Menu, Enable Standby mode

## 10.10 Lens features

### What can be done?

Some lens features can be disabled once they are correctly aligned so that a misalignment during a show is not possible.

### How to enable/disable

1. In the main menu, select *System Settings* → *Lens Features*.

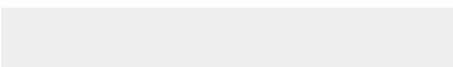

Image 10-31: System Settings menu, Lens Features

The Lens features menu is displayed.

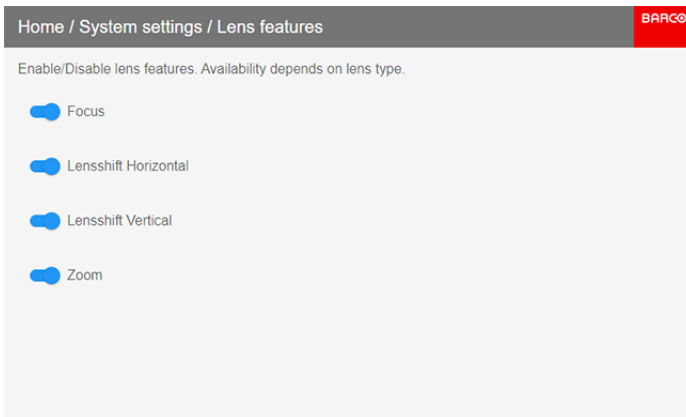

Image 10-32: Lens features menu

Depending on the lens type, different functions are available such as:

- Focus
- Horizontal lens shift
- Vertical lens shift
- Zoom

2. To enable/disable a feature, click on the slider and drag it to the left to disable the feature or the right to enable the feature.

When enabled, the slider becomes blue; when disabled, the slider is gray.

## 10.11 Controlling the backlight of the LCD Display

### What lighting can be controlled?

You can choose how quickly the backlight of the LCD turns off. You can select one of the default values, or enter a custom value.

### Stealth Mode

Alternatively, you can turn on **Stealth Mode** instead. By activating this mode, the backlight of the LCD, the backlight of all the buttons of the keypad and the indication LEDs for the LAN and HDbaseT inputs will be disabled

**Stealth Mode** is enabled and disabled by pressing the OSD button on the remote control for 3 seconds.

### How to set the backlight

1. In the main menu, *System Settings* → *Backlight*.

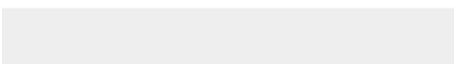

Image 10-33: System settings, Backlight

The Backlight menu will be displayed.

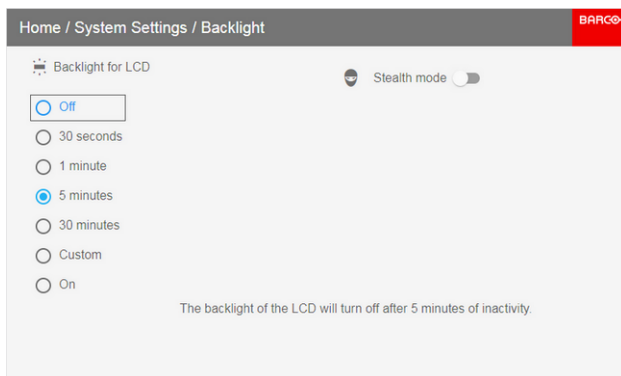

Image 10-34: Backlight menu

2. Choose the desired setting for the backlights. Select one of the predetermined options, or a custom value.

## 10.12 Reset

### What can be done?

All settings and values on the projector can be reset to its default values. This can be done for one or more settings separately, or all settings together (factory reset).

### Default settings

The following settings are default settings:

Option	Setting	Factory setting
DMX	DMX Mode	Basic
	Start Channel	1
Illumination	Power	100%
ImageBlend	Blend/Mask size Black Level	Disabled, all value to zero
	Black Level Files Blend Files	Disabled, all files deleted
ImageConnector	Color Space	auto
	Signal Range	auto
ImageConvergence	Electronic Convergence	All values to zero
ImageDisplay	Display mode	AutoStereo
ImageFeatures	Contrast	mid value
	Brightness	mid value
	Saturation	mid value
	Sharpness	mid value
	Gamma	mid value
	Cropping	Off
	Aspect Ratio	16:9
	Scaling	Fill Aspect ratio
ImageOrientation	Orientation	Table, Front
ImageRealColor	P7 Realcolor	all set to native
ImageResolution	Output Resolution (if applicable)	4K UHD
ImageSource	Source files	Standard
ImageStereo	Sync delay	0 $\mu$ s
	Swap eye	Off
	Dark time	lowest value available
ImageTestPattern	Test Pattern	Off, none selected
ImageWarp	Screen size	5120x3200 / 2560x1600
	4 corner Bow	Warp disabled, no warp
	Warp files	Disabled, all warp files deleted
Network	Communication	LAN, Automatic settings

Option	Setting	Factory setting
Optics	High Contrast	Off
Peripheral	Settings for External Cooler	Cooling mode set to internal.
	Settings for Motorized Frame	All values to mid value
Profile	Settings for projector profile and macro's	All profiles are deleted
Screen	Screen luminance - Unit	nits
System	Eco Mode / Standby Mode (depending on availability)	Enabled
	Ready Time-out	auto
User	User profiles	Only default users remain
UserInterface	Theme	Dark

### How to reset all projector settings

1. In the main menu, select *System Settings* → *Maintenance* → *Reset*.
2. In the Reset menu, select **RESET ALL** and click **OK**.

### How to reset one or more projector settings

1. In the main menu, select *System Settings* → *Maintenance* → *Reset*.

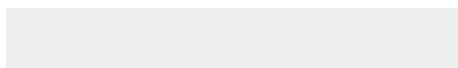

Image 10-35: System Settings menu, Reset

The Reset menu is displayed.

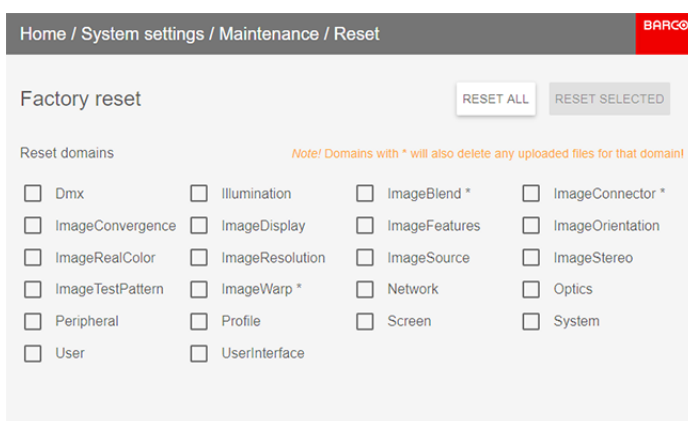

Image 10-36: Reset menu

2. Navigate to the checkbox next to the settings that need to be reset and press **OK**. Multiple selections are possible.
3. Select **RESET** and press **OK** to reset all selected settings.



## 10.13 Lens Calibration



Lens calibration is a time consuming operation.

### How to calibrate

1. In the main menu, *System Settings* → *Maintenance* → *Lens Calibration*.

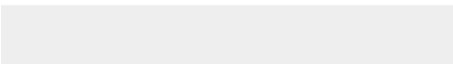

Image 10-37: Maintenance menu, Lens Calibration

The Lens Calibration menu is displayed.

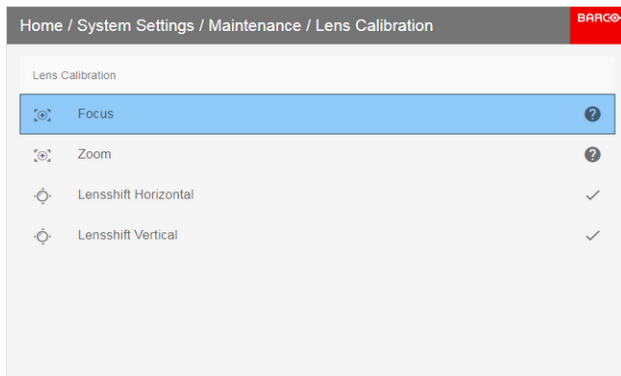

Image 10-38: Lens Calibration menu

2. In the Lens Calibration menu, select the desired calibration action and click **OK**.

You can select one of the following functions:

- Horizontal shift
- Vertical shift
- Focus
- Zoom

The text **Calibration in progress** will be displayed next to selected function until the calibration is completed.

When an error is detected, the message *Calibration Error* is displayed next to function.

## 10.14 Flex brightness

### Overview

With the FLEX technology the projector owners can lock the light output to different levels. The locking can be done via 3 different ways:

- Via Projector Toolset when connected via an Ethernet connection with the projector. See Projector Toolset's user guide, chapter ““FLEX, light output control””.
- Via the OSD menu of the projector itself
- Via an SMS message send to a projector equipped with an optional GSM board.

To lock to a specific value a 4 digit code is necessary; These codes can be created by the projector owner using Projector Toolset.

### Availability

The Flex brightness function is license protected. This license is already available in UDX 4k32, U32 and W32. To activate the Flex brightness a Flex code is necessary. This Flex code can be requested for free and uploaded via Projector Toolset. For more information about uploading this Flex code, see Projector Toolset's user guide, chapter ““FLEX, light output control””.

For other models, Flex brightness is an option. You can order and buy a license file. This license file is linked with the projector type and projector serial number. Once you received you license file, upload this file via Projector Toolset to your projector. Once the file is uploaded, the same file has to be used to upload the Flex code.

### Flex codes

Once your Flex code is correctly uploaded, the projector creates a number of flex codes, one for each possible maximum light output. These codes are used for rental activities when adapting the light output of the projector.

The created flex codes are only visible in Projector Toolset by the projector owner. To make these visible he will need his license for this typical projector.

### Maximum Light output setup via OSD menu

1. In the main menu, select *System Settings* → *Maintenance* → *Flex*.

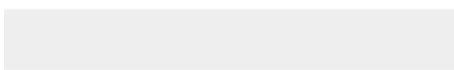

Image 10-39: Maintenance menu, Flex

The *Flex* menu is displayed.

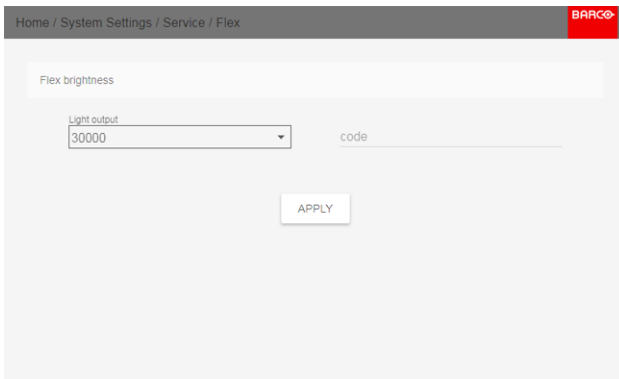

Image 10-40: Flex menu

2. Choose the desired Light output (in lumens) for which you have a code available.
3. Enter the code via the OSD menu and Select **APPLY** and click **OK**.

## 10.15 Rigging frame Calibration

### How to calibrate the Rigging frame

1. In the main menu, select *System Settings* → *Maintenance* → *Frame Calibration*.



Image 10-41: Maintenance menu, Frame Calibration

The Frame Calibration menu is displayed.

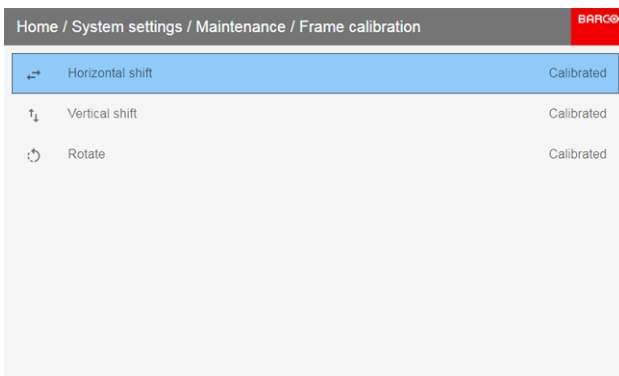

Image 10-42: Frame Calibration menu

2. In the Frame Calibration menu, select the desired calibration action and click **OK**.

You can select one of the following functions:

- Horizontal shift
- Vertical shift
- Rotate

The text **Calibration in progress** will be displayed next to selected function until the calibration is completed.

When an error is detected, the message *Calibration Error* is displayed next to function.

## 10.16 Electronic Convergence

### What can be done?

The convergence patterns can be used to check the convergence alignment of red, green and blue. If there is a misalignment of at least one 1 pixel, an electronic realignment is possible.

Mechanical realignment of the convergence can only be done by a qualified service technician.

### How to display the convergence settings

1. In the main menu, navigate to *System Settings* → *Maintenance* → *Electronic Convergence*.



Image 10-43: Maintenance menu, Electronic Convergence

The Electronic Convergence menu is displayed.

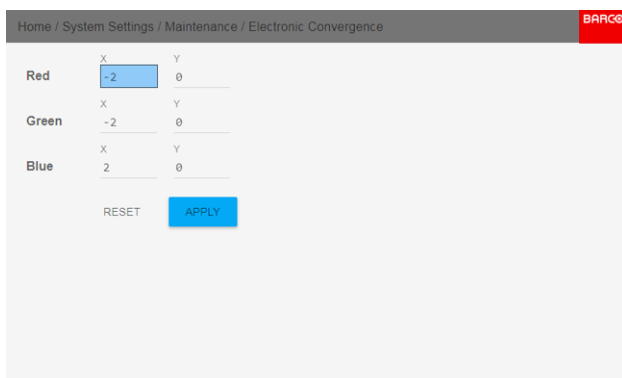

Image 10-44

2. Select the desired X or Y value for one of the three colors and confirm.
3. Use the arrow keys to raise or lower the value and confirm.
4. Confirm all changes by pressing **Apply**.

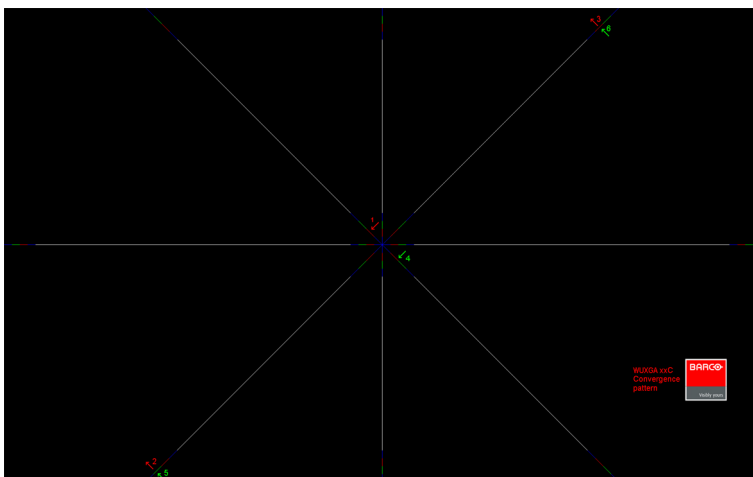

Image 10-45



*Tip:* Press **Reset** to return all values to the factory settings.

5. Repeat all steps until the desired alignment is achieved.

## 10.17 Advanced Settings

### About the Advanced Settings menu

The Advanced Settings menu is hidden by default for the regular user. you can only make this visible after entering a *Service code* with the remote control.

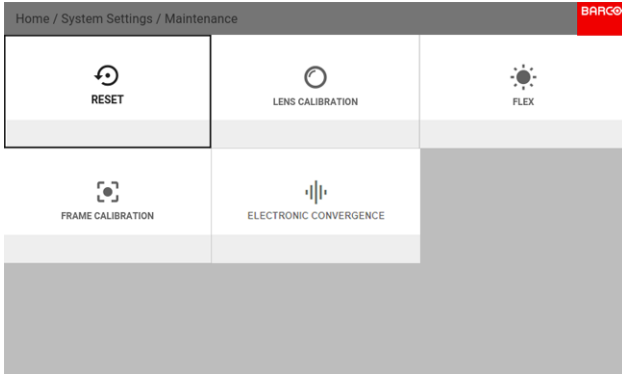

Image 10-46: Maintenance menu, with the Advanced Settings Hidden

If you have a service code, navigate to the Maintenance menu. Enter the code with the numeric keys. If entered correctly, the Advanced Settings option will become visible.



It doesn't matter what else you do or type with the remote. As long as you type in the service code in the correct order, the Advanced Settings option will become visible.



ADVANCED SETTINGS

Statistics, Color, Laser Banks

Image 10-47: Maintenance menu, Advanced Settings



The Advanced Settings menu item will remain visible until you leave the Maintenance menu.

### Overview

- Advanced Settings – Color
- Advanced Settings – Statistics
- Checking the status of the Laser Banks

## 10.17.1 Advanced Settings – Color



**CAUTION:** The native colors have been measured and set during factory production. Do not change them, unless parts of the optical path have been replaced due to servicing. If you need to change the native colors on the device, make sure to also perform a **P7 calibration**, using the Projector Toolset and a chroma meter. For more info on P7 calibration, refer to the Projector Toolset Reference guide.

### How to adjust the P7 native settings

1. In the main menu, navigate to *System Settings* → *Maintenance* → *Advanced Settings*.



Statistics, Color, Laser Banks

Image 10-48: Maintenance menu, Advanced Settings

2. In the Advanced Settings menu, select *Color*.



Image 10-49: Advanced Settings Menu, Color

The Color menu will be displayed.

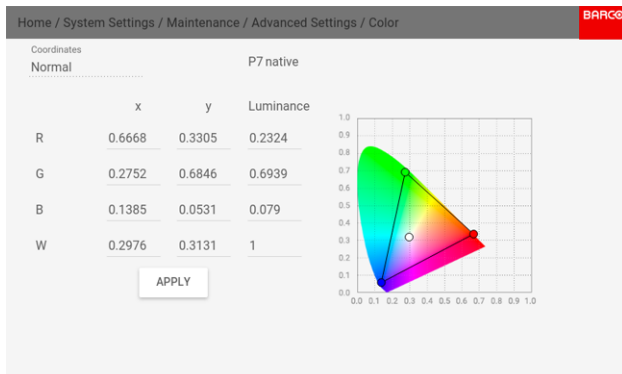

Image 10-50: Color menu

3. Select the desired value to change and confirm.
4. Change the values to the desired position, taking into account the color gamut values.
5. Select **APPLY** and click **OK**.



## 10.17.2 Advanced Settings – Statistics

### What can be seen?

The statistics screen shows the general information about the projector.

The following items will be displayed:

- Laser runtime
- Laser Strikes
- Projector Runtime
- System time
- Current Uptime

### How to display the statistics

1. In the main menu, navigate to *System Settings* → *Maintenance* → *Advanced Settings*.



Statistics, Color, Laser Banks

Image 10-51: Maintenance menu, Advanced Settings

2. In the Advanced Settings menu, select *Statistics*.



Image 10-52: Advanced Settings menu, Statistics

The Statistics will be displayed.

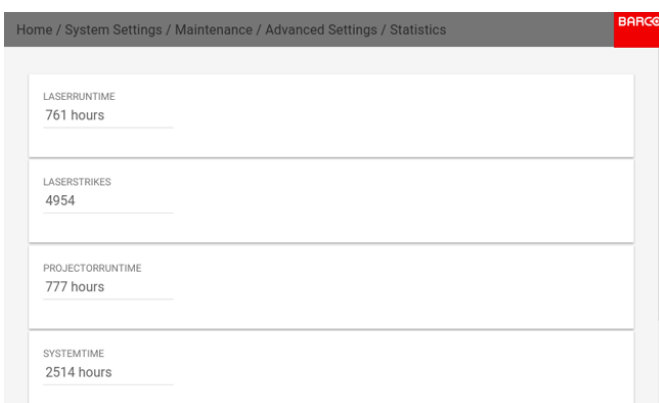

Image 10-53: Statistics menu

## 10.17.3 Checking the status of the Laser Banks

### About failing laser banks

The projector is powered by a laser light source, which has multiple laser banks. The light output and color performance is dependant on the number of active laser banks.

If one or more laser banks have failed of a certain type, you will notice a decreased light input and decrease in color performance. But the projector will keep on playing, unless too many banks of a certain color will have failed.



In order to disable a certain laser bank, or calibrate the projector after disabling one or more laser banks, please refer to the Projector Toolset User Manual.

### How to check the status of the Laser Banks

1. In the main menu, *System Settings* → *Service*.



Color, Statistics, Lens Calibration, Opti...

Image 10-54

2. Enter the service code.
3. In the *Service* menu, select *Laser Banks*.



Image 10-55: Service menu, Laser Banks

The Laser Banks menu is displayed.

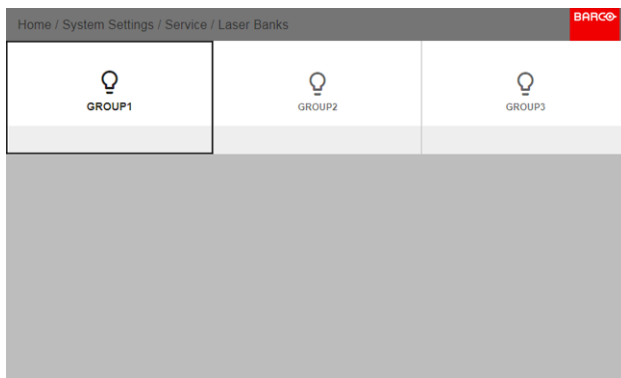

Image 10-56: Laser Banks menu

4. Select the desired laser group menu.
5. In the laser banks group page, you can see which laser banks are part of this specific group. You can also see which laser banks are operational and which have failed.

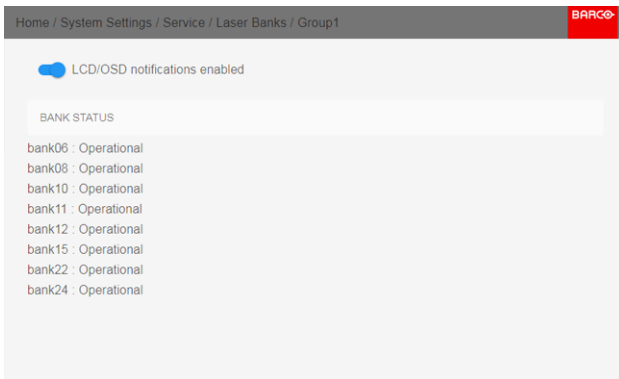

Image 10-57

6. If you want notifications to be disabled for a specific group of laser banks, disable the *LCD/OSD notifications enabled* button.



# Status menu

# 11



This is a status menu only. No changes can be made to settings from this menu.

## Overview

- Status menu overview

## 11.1 Status menu overview

### Status menu

While in the main menu, press Status.

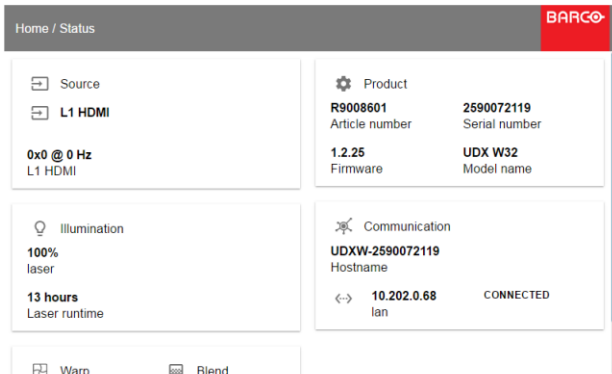

Image 11-1: Status overview

### Source status

Displays active source information

### Product

Displays active product information:

- Article number: Projector article / part number
- Serial number: Projector serial number
- Firmware: Projector software package version
- Model name: Projector model name

### Illumination

Shows the used light source power (in %) and runtime.

### Communication

Lists the projector network address, the remote control broadcast address and the remote control projector address.

### Warp

Displays the Warp status and type of warp used

### Blend

Displays the Warp status and type of Blend used

### Environment

Shows the ambient temperature.

### Display

Shows display settings

### Active Functions

Shows the active function enabled.

# Maintenance

# 12

## About this chapter

This chapter contains general maintenance procedures.

## Overview

- Cleaning the lens
- Cleaning the exterior of the projector

## 12.1 Cleaning the lens



To minimize the possibility of damage to optical coatings, or scratches to lens surfaces follow the cleaning procedure as described here precisely.

### Required tools

- Compressed air
- Clean micro fiber lens cleaning cloth (e.g. Toraysee® cloth(s))
- Clean cotton cloth
- Lens cleaner (e.g. ZEISS lens cleaner, Purosol™ or other water based lens cleaner products)

### How to clean the lens?

1. Blow off dust with clean compressed air (or pressurized air cans<sup>8</sup>).
2. Clean with lens cleaner together with a clean lens cleaning cloth to remove the dust and contamination. Use big wipes in one single direction.
  -  **Warning:** Do not wipe back and forwards across the lens surface as this tends to grind dirt into the coating.
3. Use a dry lens cleaning cloth to remove left liquid or stripes. Polish with small circles.
4. If there are still fingerprints on the surface, wipe them off with lens cleaner together with a clean lens cleaning cloth. Polish again with a dry one.



If smears occur when cleaning lenses, replace the cloth. Smears are the first indication of a dirty cloth.

8: Pressurized air cans are not efficient if there is too much dust on the surface, the pressure is too low



## 12.2 Cleaning the exterior of the projector

### How to clean the exterior of the projector ?

1. Switch off the projector and unplug the projector from the mains power net.
2. Clean the housing of the projector with a damp cloth. Stubborn stains may be removed with a cloth lightly dampened with a mild detergent solution.



# Specifications

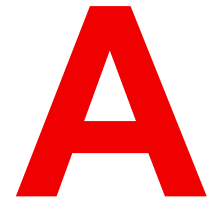

## About this chapter

This chapter gives an overview of the specification of the UDX projector as well as the dimensions and the center of gravity.

## Overview

- Specifications of the UDX-4K40
- Specifications of the UDX-4K32
- Specifications of the UDX-4K22
- Specifications of the UDX-W40
- Specifications of the UDX-W32
- Specifications of the UDX-W26
- Specifications of the UDX-W22
- Specifications of the UDX-U40
- Specifications of the UDX-U32
- Dimensions of a UDX
- Dimensions of the rigging frame
- Dimensions of the flight case
- Technical Regulations

## A.1 Specifications of the UDX-4K40

### Specifications

<b>Projector type</b>	4K UHD 3-chip DLP digital projector
<b>Technology</b>	0.9 DMD™ x3
<b>Resolution</b>	3,840 x 2,400 (4K UHD) / 2,560 x 1,600 (native) / 5,120 x 3,200 (processing)
<b>Brightness</b>	37,500 (WQ)/36,500 (4K UHD) center lumens // 36,500 (WQ)/35,500 (4K UHD) ansi lumen // 40,000 ISO
<b>Contrast ratio</b>	2,000:1
<b>Brightness uniformity</b>	95%
<b>Aspect ratio</b>	16:10
<b>ScenergiX</b>	Horizontal and vertical edge blending
<b>Lenses</b>	TLD+ 0.37, 0.65-0.85, 0.8-1.16:1 ; 1.25-1.6:1 ; 1.5-2.0:1 ; 2.0-2.8:1 ; 2.8-4.5:1 ; 4.5-7.5:1 ; 7.5-11.5:1
<b>Optical lens shift</b>	Vertical between -100% to +130%, depending on lens Horizontal up to +/- 40%, depending on lens Motorized zoom and focus (with lens memory on TLD lenses) Motorized lens shift (with position memory on all lenses)
<b>Color correction</b>	P7
<b>Light source</b>	laser phosphor with inorganic phosphor wheel
<b>Light source lifetime</b>	20,000 hrs
<b>Optical dowser</b>	Digital
<b>Picture-in-picture</b>	Two sources simultaneously
<b>Orientation</b>	360°
<b>Sealed DLP™ core</b>	standard
<b>DMX 512</b>	standard
<b>WARP</b>	Direct adjust OSD + toolset
<b>Image processing</b>	Embedded warp & blend
<b>Keystone correction</b>	Yes
<b>Integrated web server</b>	Yes
<b>CLO (constant light output)</b>	Standard
<b>3D</b>	Active eye wear (optional), passive circular (optional); 2 flash up to 240Hz*
<b>Inputs</b>	Single HDBaseT; HDMI2.0 (HDCP2.2, HDR10); DP 1.2 (HDCP 1.3); Quad 3G/12G SDI / BarcoLink Ultra
<b>Optional Inputs</b>	Quad DP1.2, Fiber SFP input
<b>Input resolutions</b>	From NTSC up to 4K (4,096 x 2,160) refresh rates: 24hz to 120hz 4K/4KUHD (4096 x 2160/ 3860 x 2400) to 240hz WQXGA (2560 x 1600)
<b>Max. pixel clock</b>	600 MHz

<b>Software tools</b>	Projector Toolset + Android** app + iOS** app
<b>Control</b>	XLR wired + IR, RS232, Wifi** (opt), GSM** (opt)
<b>Network connection</b>	10/100 base-T, RJ-45 connection, Wifi** (optional)
<b>Power requirements</b>	120-160 V (reduced power) / 200-240V (+/- 10%), 20A, 50-60Hz
<b>Max. power consumption</b>	3750W
<b>Noise level (typical at 25°C/ 77°F)</b>	58dB(A)
<b>Operational ambient temperature</b>	0-40°C / 32°-104°F (reduce power >35°C)
<b>Operational humidity</b>	0-80% (non condens)
<b>Dissipation BTU</b>	Max. 12,795 BTU/h
<b>Dimensions (WxLxH)</b>	660 x 830 x 350 mm / 25.98 x 32.67 x 13.77 inches
<b>Shipping Dimensions</b>	(WxLxH) 800 x 1,200 x 685 mm / 31.49 x 47.24 x 26.96 inches
<b>Weight</b>	92kg (202 lbs)/shipping weight from factory: 110kg (242 lbs)
<b>Standard accessories</b>	Power cord, wireless/XLR wired rugged remote control
<b>Certifications</b>	Compliant with UL60950-1 and EN60950-1 complies with FCC rules & regulations, part 15 Class A and CE EN55032 Class A, Rohs
<b>Warranty</b>	3 years

## A.2 Specifications of the UDX-4K32

### Specifications

<b>Projector type</b>	4K UHD 3-chip DLP digital projector
<b>Technology</b>	0.9" DMD™ x3
<b>Resolution</b>	3,840 x 2,400 (4K UHD) / 2,560 x 1,600 (native) / 5,120 x 3,200 (processing)
<b>Brightness</b>	31,000 (WQ)/30,000 (4K UHD) center lumens* // 30,000 (WQ)/29,000 (4K UHD) ansi lumens // 33,000 ISO
<b>Contrast ratio</b>	2,000:1
<b>Brightness uniformity</b>	95%
<b>Aspect ratio</b>	16:10
<b>ScenergiX</b>	Horizontal and vertical edge blending
<b>Lenses</b>	TLD+ 0.37, 0.65-0.85, 0.8-1.16:1 ; 1.25-1.6:1 ; 1.5-2.0:1 ; 2.0-2.8:1 ; 2.8-4.5:1 ; 4.5-7.5:1 ; 7.5-11.5:1
<b>Optical lens shift</b>	Vertical between -100% to +130%, depending on lens Horizontal up to +/- 40%, depending on lens Motorized zoom and focus (with lens memory on TLD lenses) Motorized lens shift (with position memory on all lenses)
<b>Color correction</b>	P7
<b>Light source</b>	laser phosphor with inorganic phosphor wheel
<b>Light source lifetime</b>	25,000 hrs
<b>Optical dowser</b>	Digital
<b>Picture-in-picture</b>	Two sources simultaneously
<b>Orientation</b>	360°
<b>Sealed DLP™ core</b>	standard
<b>DMX 512</b>	standard
<b>WARP</b>	Direct adjust OSD + toolset
<b>Image processing</b>	Embedded warp & blend
<b>Keystone correction</b>	Yes
<b>Integrated web server</b>	Yes
<b>CLO (constant light output)</b>	Standard
<b>3D</b>	Active eye wear (optional), passive circular (optional); 2 flash up to 200Hz*
<b>Inputs</b>	Single HDBaseT; HDMI2.0 (HDCP2.2, HDR10); DP 1.2 (HDCP 1.3); Quad 3G/12G SDI / BarcoLink
<b>Optional Inputs</b>	Quad DP1.2
<b>Input resolutions</b>	From NTSC up to 4K (4,096 x 2,160) refresh rates: 24hz to 120hz 4K/4KUHD (4096 x 2160/ 3860 x 2400) to 240hz WQXGA (2560 x 1600)
<b>Max. pixel clock</b>	600 MHz

<b>Software tools</b>	Projector Toolset + Android** app + iOS** app
<b>Control</b>	XLR wired + IR, RS232, Wifi** (opt), GSM** (opt)
<b>Network connection</b>	10/100 base-T, RJ-45 connection, Wifi** (optional)
<b>Power requirements</b>	120-160 V (reduced power) / 200-240V (+/- 10%), 20A, 50-60Hz
<b>Max. power consumption</b>	2,900W nom/3,100W max / STBY less than 10W
<b>Noise level (typical at 25°C/ 77°F)</b>	52dB(A)
<b>Operational ambient temperature</b>	0-40°C / 32°-104°F
<b>Operational humidity</b>	0-80% (non condens)
<b>Dissipation BTU</b>	Max. 9,895 BTU/h
<b>Dimensions (WxLxH)</b>	660 x 830 x 350 mm / 25.98 x 32.67 x 13.77 inches
<b>Shipping Dimensions</b>	(WxLxH) 800 x 1,200 x 685 mm / 31.49 x 47.24 x 26.96 inches
<b>Weight</b>	92kg (202 lbs)/shipping weight from factory: 110kg (242 lbs)
<b>Standard accessories</b>	Power cord, wireless/XLR wired rugged remote control
<b>Certifications</b>	Compliant with UL60950-1 and EN60950-1 complies with FCC rules & regulations, part 15 Class A and CE EN55032 Class A, Rohs
<b>Warranty</b>	3 years
*	+/- 10%

## A.3 Specifications of the UDX-4K22

### Specifications

<b>Projector type</b>	4K UHD 3-chip DLP digital projector
<b>Technology</b>	0.9" DMD™ x3
<b>Resolution</b>	3,840 x 2,400 (4K UHD) / 2,560 x 1,600 (native) / 5,120 x 3,200 (processing)
<b>Brightness</b>	20,000 (WQ)/19,000 (4K UHD) center lumens* // 19,000 (WQ)/18,000 (4K UHD) ansi lumens // 21,500 ISO
<b>Contrast ratio</b>	2,000:1
<b>Brightness uniformity</b>	95%
<b>Aspect ratio</b>	16:10
<b>ScenergiX</b>	Horizontal and vertical edge blending
<b>Lenses</b>	TLD+ 0.37, 0.65-0.85, 0.8-1.16 ; 1.25-1.6:1 ; 1.5-2.0:1 ; 2.0-2.8:1 ; 2.8-4.5:1 ; 4.5-7.5:1 ; 7.5-11.5:1
<b>Optical lens shift</b>	Vertical between -100% to +130%, depending on lens Horizontal up to +/- 40%, depending on lens Motorized zoom and focus (with lens memory on TLD lenses) Motorized lens shift (with position memory on all lenses)
<b>Color correction</b>	P7
<b>Light source</b>	Laser phosphor with inorganic phosphor wheel
<b>Light source lifetime</b>	25,000 hrs
<b>Optical dowser</b>	Digital
<b>Picture-in-picture</b>	Two sources simultaneously
<b>Sealed DLP™ core</b>	Standard
<b>Orientation</b>	360°
<b>DMX 512</b>	standard
<b>WARP</b>	Direct adjust OSD + toolset
<b>Image processing</b>	Embedded warp & blend
<b>Keystone correction</b>	Yes
<b>Integrated web server</b>	Yes
<b>CLO (constant light output)</b>	Standard
<b>3D</b>	Active eye wear (optional), passive circular (optional); 2 flash up to 200Hz*
<b>Inputs</b>	Single HDBaseT; HDMI2.0 (HDCP2.2, HDR10); DP 1.2 (HDCP 1.3); Quad 3G/12G SDI / BarcoLink
<b>Optional Inputs</b>	Quad DP1.2
<b>Input resolutions</b>	From NTSC up to 4K (4,096 x 2,160) refresh rates: 24hz to 120hz 4K/4KUHD (4096 x 2160/ 3860 x 2400) to 240hz WQXGA (2560 x 1600)
<b>Max. pixel clock</b>	600 Mhz



<b>Software tools</b>	Projector Toolset + Android* app + iOS* app
<b>Control</b>	XLR wired + IR, RS232, Wifi* (opt), GSM* (opt)
<b>Network connection</b>	10/100 base-T, RJ-45 connection, Wifi* (optional)
<b>Power requirements</b>	120-160 V(reduced power) / 200-240 V (+/- 10%), 20 A, 50-60 Hz
<b>Max. power consumption</b>	1,900W @ 230 volts STBY<10W
<b>Noise level (typical at 25°C/ 77°F)</b>	49 dB(A)
<b>Operational ambient temperature</b>	0°-40°C/ 32°-104°F (45°C reduced power)
<b>Operational humidity</b>	0-80% (non condens)
<b>Dissipation BTU</b>	Max. 6,600 BTU/h
<b>Dimensions (WxLxH)</b>	660 x 830 x 350 mm (25.98 x 32.67 x 13.77")
<b>Shipping Dimensions</b>	(WxLxH) 980 x 1,200 x 760 mm (38.58 x 47.24 x 29.92")
<b>Weight</b>	87.5 kg (193 lbs)/shipping weight from factory: 105 kg (231 lbs)
<b>Standard accessories</b>	Power cord, wireless/XLR wired rugged remote control
<b>Certifications</b>	Compliant with UL60950-1 and EN60950-1, complies with FCC rules & regulations, part 15 Class A and CE EN55032 Class A, Rohs
<b>Warranty</b>	3 years
*	Software upgradeable. Check with your local authorized Barco sales representative for full details.

## A.4 Specifications of the UDX-W40

### Specifications

<b>Projector type</b>	WUXGA 3-chip DLP digital projector
<b>Resolution</b>	1920 x 1200
<b>Technology</b>	0.98 DMD™ x3
<b>Brightness</b>	40,000 center lumen/ 39,000 ansi lumen / 43,000 ISO
<b>Contrast ratio</b>	2,000:1
<b>Brightness uniformity</b>	95%
<b>Aspect ratio</b>	16:10
<b>ScenergiX</b>	Horizontal and vertical edge blending
<b>Lenses</b>	TLD+ 0.37, 0.65-0.85, 0.8-1.16:1 ; 1.25-1.6:1 ; 1.5-2.0:1 ; 2.0-2.8:1 ; 2.8-4.5:1 ; 4.5-7.5:1 ; 7.5-11.5:1
<b>Optical lens shift</b>	Vertical between -100% to +130%, depending on lens Horizontal up to +/- 40%, depending on lens Motorized zoom and focus (with lens memory on TLD lenses) Motorized lens shift (with position memory on all lenses)
<b>Color correction</b>	P7
<b>Light source</b>	laser phosphor with inorganic phosphor wheel
<b>Light source lifetime</b>	20,000 hrs
<b>Optical dowser</b>	Digital
<b>Picture-in-picture</b>	Two sources simultaneously
<b>Orientation</b>	360°
<b>Sealed DLP™ core</b>	standard
<b>DMX 512</b>	standard
<b>WARP</b>	Direct adjust OSD + toolset
<b>Image processing</b>	Embedded warp & blend
<b>Keystone correction</b>	Yes
<b>Integrated web server</b>	Yes
<b>CLO (constant light output)</b>	Standard
<b>3D</b>	Active eye wear (optional), passive circular (optional); 2 flash up to 200Hz*
<b>Inputs</b>	Single HDBaseT; HDMI2.0 (HDCP2.2, HDR10); DP 1.2 (HDCP 1.3); Quad 3G/12G SDI / BarcoLink Ultra
<b>Optional Inputs</b>	Quad DP1.2, Fiber SFP input
<b>Input resolutions</b>	From NTSC up to 4K (4,096 x 2,160) refresh rates: 24hz to 120hz 4K/4KUHD (4096 x 2160/ 3860 x 2400) to 240hz WQXGA (2560 x 1600)
<b>Max. pixel clock</b>	600 MHz
<b>Software tools</b>	Projector Toolset + Android** app + iOS** app

<b>Control</b>	XLR wired + IR, RS232, Wifi** (opt), GSM** (opt)
<b>Network connection</b>	10/100 base-T, RJ-45 connection, Wifi** (optional)
<b>Power requirements</b>	120-160 V (reduced power) / 200-240V (+/- 10%), 20A, 50-60Hz
<b>Max. power consumption</b>	3750W
<b>Noise level (typical at 25°C/ 77°F)</b>	58dB(A)
<b>Operational ambient temperature</b>	0-40°C / 32°-104°F (reduce power >35°C)
<b>Operational humidity</b>	0-80% (non condens)
<b>Dissipation BTU</b>	Max. 12,795 BTU/h
<b>Dimensions (WxLxH)</b>	660 x 830 x 350 mm / 25.98 x 32.67 x 13.77 inches
<b>Shipping Dimensions</b>	(WxLxH) 800 x 1,200 x 685 mm / 31.49 x 47.24 x 26.96 inches
<b>Weight</b>	92kg (202 lbs)/shipping weight from factory: 110kg (242 lbs)
<b>Standard accessories</b>	Power cord, wireless/XLR wired rugged remote control
<b>Certifications</b>	Compliant with UL60950-1 and EN60950-1 complies with FCC rules & regulations, part 15 Class A and CE EN55032 Class A, Rohs
<b>Warranty</b>	3 years

## A.5 Specifications of the UDX-W32

### Specifications

<b>Projector type</b>	WUXGA 3-chip DLP digital projector
<b>Technology</b>	0.96" DMD™ x3
<b>Resolution</b>	1,920 x 1,200
<b>Brightness</b>	32,000 center lumens* / 31,000 ansi lumen / 34,000 ISO
<b>Contrast ratio</b>	2,000:1
<b>Brightness uniformity</b>	95%
<b>Aspect ratio</b>	16:10
<b>ScenergiX</b>	Horizontal and vertical edge blending
<b>Lenses</b>	TLD+ 0.37, 0.65-0.85, 0.73:1 ; 1.2:1 ; 0.8-1.16 ; 1.25 -1.6:1 ; 1.5-2.0:1 ; 2.0-2.8:1 ; 2.8-4.5:1 ; 4.5-7.5:1 ; 7.5-11.5:1
<b>Optical lens shift</b>	Vertical between -100% to +130%, depending on lens Horizontal up to +/- 40%, depending on lens Motorized zoom and focus (with lens memory on TLD lenses) Motorized lens shift (with position memory on all lenses)
<b>Color correction</b>	P7
<b>Light source</b>	laser phosphor with inorganic phosphor wheel
<b>Light source lifetime</b>	25,000 hrs
<b>Optical dowser</b>	Digital
<b>Picture-in-picture</b>	Two sources simultaneously
<b>Sealed DLP™ core</b>	Standard
<b>Orientation</b>	360°
<b>DMX 512</b>	Standard
<b>WARP</b>	Direct adjust OSD + toolset
<b>Image processing</b>	Embedded warp & blend
<b>Keystone correction</b>	Yes
<b>Integrated web server</b>	Yes
<b>CLO (constant light output)</b>	Standard
<b>3D</b>	Active eye wear (optional), passive circular (optional); 2 flash up to 200Hz*
<b>Inputs</b>	Single HDBaseT; HDMI2.0 (HDCP2.2, HDR10); DP 1.2 (HDCP 1.3); Quad 3G/12G SDI / BarcoLink
<b>Optional Inputs</b>	Quad DP1.2
<b>Input resolutions</b>	From NTSC up to 4K (4,096 x 2,160) refresh rates: 24hz to 120hz 4K/4KUHD (4096 x 2160/ 3860 x 2400) to 240hz WQXGA (2560 x 1600)
<b>Max. pixel clock</b>	600 MHz
<b>Software tools</b>	Projector Toolset + Android** app + iOS** app

<b>Control</b>	XLR wired + IR, RS232, Wifi** (opt), GSM** (opt)
<b>Network connection</b>	10/100 base-T, RJ-45 connection, Wifi** (optional)
<b>Power requirements</b>	120-160V (reduced power) / 200-240V (+/- 10%), 20A, 50-60Hz
<b>Max. power consumption</b>	2,900 W nom / 3,100 W max. / STBY less than 10 W
<b>Noise level (typical at 25°C/ 77°F)</b>	52dB(A)
<b>Operational ambient temperature</b>	0-40°C / 32°-104°F
<b>Operational humidity</b>	0-80% (non condens)
<b>Dissipation BTU</b>	Max. 9,895 BTU/h
<b>Dimensions (WxLxH)</b>	660 x 830 x 350 mm / 25.95 x 32.7 x 13.78 inches
<b>Shipping Dimensions</b>	(WxLxH) 800 x 1200 x 685 mm / 31.49 x 47.24 x 26.96 inches
<b>Weight</b>	92kg (202 lbs)/shipping weight from factory: 110kg (242 lbs)
<b>Standard accessories</b>	Power cord, wireless/XLR wired rugged remote control
<b>Certifications</b>	Compliant with UL60950-1 and EN60950-1 complies with FCC rules & regulations, part 15 Class A and CE EN55032 Class A, Rohs
<b>Warranty</b>	3 years
*	+/- 10%

## A.6 Specifications of the UDX-W26

### Specifications

<b>Projector type</b>	WUXGA 3-chip DLP digital projector
<b>Technology</b>	0.96" DMD™ x3
<b>Resolution</b>	1,920 x 1,200
<b>Brightness</b>	26,000 center lumens* / 25,000 ansi lumens / 28,000 ISO
<b>Contrast ratio</b>	2,000:1
<b>Brightness uniformity</b>	95%
<b>Aspect ratio</b>	16:10
<b>ScenergiX</b>	Horizontal and vertical edge blending
<b>Lenses</b>	TLD+ 0.37:1 ; 0.65:1 ; 0.73:1 ; 0.85:1 ; 1.2:1 ; 1.25 -1.6:1 ; 1.5-2.0:1 ; 2.0-2.8:1 ; 2.8-4.5:1 ; 4.5-7.5:1 ; 7.5-11.5:1
<b>Optical lens shift</b>	Vertical between -100% to +130%, depending on lens Horizontal up to +/- 40%, depending on lens Motorized zoom and focus (with lens memory on TLD lenses) Motorized lens shift (with position memory on all lenses)
<b>Color correction</b>	P7
<b>Light source</b>	Laser phosphor with inorganic phosphor wheel
<b>Light source lifetime</b>	40,000 hrs
<b>Optical dowser</b>	Digital
<b>Picture-in-picture</b>	Two sources simultaneously
<b>Sealed DLP™ core</b>	standard
<b>Orientation</b>	360°
<b>DMX 512</b>	standard
<b>WARP</b>	Direct adjust OSD + toolset
<b>Image processing</b>	Embedded warp & blend
<b>Keystone correction</b>	Yes
<b>Integrated web server</b>	Yes
<b>CLO (constant light output)</b>	Standard
<b>3D</b>	Active eye wear (optional), passive circular (optional); 2 flash up to 200Hz*
<b>Inputs</b>	Single HDBt; HDMI2.0 (HDCP2.2, HDR10); DP 1.2 (HDCP 1.3); Quad 3G/12G SDI / BarcoLink
<b>Optional Inputs</b>	Quad DP1.2
<b>Input resolutions</b>	From NTSC up to 4K (4,096 x 2,560) refresh rates: 24hz to 120hz 4K/4KUHD (4096 x 2160/ 3860 x 2400) to 240hz WQXGA (2560 x 1600)
<b>Max. pixel clock</b>	600 Mhz
<b>Software tools</b>	Projector Toolset + Android app* + iOS app*

<b>Control</b>	XLR wired + IR, RS232, Wifi (opt), GSM (opt)
<b>Network connection</b>	10/100 base-T, RJ-45 connection, Wifi (optional)*
<b>Power requirements</b>	120-160V (reduced power)/ 200-240V (+/- 10%), 20A, 50-60Hz (reduced power on 110v)
<b>Max. power consumption</b>	2,450W nom/2,650W max. / STBY less than 10W
<b>Noise level (typical at 25°C/ 77°F)</b>	52dB(A)
<b>Operational ambient temperature</b>	0°-40°C/ 32°-104°F (45°C reduced power)
<b>Operational humidity</b>	0-80% (non condens)
<b>Dissipation BTU</b>	Max. 8,342 BTU/h
<b>Dimensions (WxLxH)</b>	660 x 830 x 350 mm (25.98 x 32.67 x 13.77")
<b>Shipping Dimensions</b>	(WxLxH) 800 x 1,200 x 685 mm (31.49 x 47.24 x 26.96")
<b>Weight</b>	92kg (202 lbs)/shipping weight from factory: 110kg (242 lbs)
<b>Standard accessories</b>	Power cord, wireless/XLR wired rugged remote control
<b>Certifications</b>	TBD
<b>Warranty</b>	3 years
<b>*</b>	Software upgradeable, please contact your local authorized Barco sales representative

## A.7 Specifications of the UDX-W22

### Specifications

<b>Projector type</b>	WUXGA 3-chip DLP digital projector
<b>Technology</b>	0.96" DMD™ x3
<b>Resolution</b>	1,920 x 1,200
<b>Brightness</b>	21,000 center lumens* / 20,000 ansi lumens / 22,500 ISO
<b>Contrast ratio</b>	2,000:1
<b>Brightness uniformity</b>	95%
<b>Aspect ratio</b>	16:10
<b>ScenergiX</b>	Horizontal and vertical edge blending
<b>Lenses</b>	TLD+ 0.37:1 ; 0.65:1 ; 0.73:1 ; 0.85:1 ; 1.2:1 ; 1.25 -1.6:1 ; 1.5-2.0:1 ; 2.0-2.8:1 ; 2.8-4.5:1 ; 4.5-7.5:1 ; 7.5-11.5:1
<b>Optical lens shift</b>	Vertical between -100% to +130%, depending on lens Horizontal up to +/- 40%, depending on lens Motorized zoom and focus (with lens memory on TLD lenses) Motorized lens shift (with position memory on all lenses)
<b>Color correction</b>	P7
<b>Light source</b>	Laser phosphor with inorganic phosphor wheel
<b>Light source lifetime</b>	25,000 hrs
<b>Optical dower</b>	Mechanical
<b>Picture-in-picture</b>	Two sources simultaneously
<b>Sealed DLP™ core</b>	standard
<b>Orientation</b>	360°
<b>DMX 512</b>	standard
<b>WARP</b>	Direct adjust OSD + toolset
<b>Image processing</b>	Embedded warp & blend
<b>Keystone correction</b>	Yes
<b>Integrated web server</b>	Yes
<b>CLO (constant light output)</b>	Standard
<b>3D</b>	Active eye wear (optional), passive circular (optional); 2 flash up to 200Hz*
<b>Inputs</b>	Single HDBt; HDMI2.0 (HDCP2.2, HDR10); DP 1.2 (HDCP 1.3); Quad 3G/12G SDI / BarcoLink
<b>Optional Inputs</b>	Quad DP1.2
<b>Input resolutions</b>	From NTSC up to 4K (4,096 x 2,560) refresh rates: 24hz to 120hz 4K/4KUHD (4096 x 2160/ 3860 x 2400) to 240hz WQXGA (2560 x 1600)
<b>Max. pixel clock</b>	600 Mhz
<b>Software tools</b>	Projector Toolset + Android app* + iOS app*



<b>Control</b>	XLR wired + IR, RS232, Wifi (opt)*, GSM (opt)*
<b>Network connection</b>	10/100 base-T, RJ-45 connection, Wifi (optional)*
<b>Power requirements</b>	120-160V (reduced power)/ 200-240V (+/- 10%), 20A, 50-60Hz (reduced power on 110v)
<b>Max. power consumption</b>	1,900 W @ 230 volts/ STBY less than 10W
<b>Noise level (typical at 25°C/ 77°F)</b>	49 dB(A)
<b>Operational ambient temperature</b>	0°-40°C/ 32°-104°F (45°C reduced power)
<b>Operational humidity</b>	0-80% (non condens)
<b>Dissipation BTU</b>	Max. 6,600 BTU/h
<b>Dimensions (WxLxH)</b>	660 x 830 x 350 mm (25.98 x 32.67 x 13.77")
<b>Shipping Dimensions</b>	(WxLxH) 800 x 1,200 x 685 mm / 31.49 x 47.24 x 26.96 inches
<b>Weight</b>	87.5kg (193 lbs)/shipping weight from factory: 105kg (231 lbs)
<b>Standard accessories</b>	Power cord, wireless/XLR wired rugged remote control
<b>Certifications</b>	Compliant with UL60950-1 and EN60950-1 complies with FCC rules & regulations, part 15 Class A and CE EN55032 Class A, Rohs
<b>Warranty</b>	3 years
<b>*</b>	Software upgradeable, please contact your local authorized Barco sales representative

## A.8 Specifications of the UDX-U40

### Specifications

<b>Projector type</b>	UXGA 3-chip DLP digital projector
<b>Technology</b>	0.98 DMD™ x3
<b>Resolution</b>	1600 x 1200
<b>Brightness</b>	37,500 center lumen*/ 36,500 ansi lumens / 40,000 ISO
<b>Contrast ratio</b>	2,000:1
<b>Brightness uniformity</b>	95%
<b>Aspect ratio</b>	4:3
<b>ScenergiX</b>	Horizontal and vertical edge blending
<b>Lenses</b>	TLD+ 0.37, 0.65-0.85, 0.8-1.16:1 ; 1.25-1.6:1 ; 1.5-2.0:1 ; 2.0-2.8:1 ; 2.8-4.5:1 ; 4.5-7.5:1 ; 7.5-11.5:1
<b>Optical lens shift</b>	Vertical between -100% to +130%, depending on lens Horizontal up to +/- 40%, depending on lens Motorized zoom and focus (with lens memory on TLD lenses) Motorized lens shift (with position memory on all lenses)
<b>Color correction</b>	P7
<b>Light source</b>	laser phosphor with inorganic phosphor wheel
<b>Light source lifetime</b>	20,000 hrs
<b>Optical dowser</b>	Digital
<b>Picture-in-picture</b>	Two sources simultaneously
<b>Orientation</b>	360°
<b>Sealed DLP™ core</b>	standard
<b>DMX 512</b>	standard
<b>WARP</b>	Direct adjust OSD + toolset
<b>Image processing</b>	Embedded warp & blend
<b>Keystone correction</b>	Yes
<b>Integrated web server</b>	Yes
<b>CLO (constant light output)</b>	Standard
<b>3D</b>	Active eye wear (optional), passive circular (optional); 2 flash up to 200Hz*
<b>Inputs</b>	Single HDBaseT; HDMI2.0 (HDCP2.2, HDR10); DP 1.2 (HDCP 1.3); Quad 3G/12G SDI / BarcoLink Ultra
<b>Optional Inputs</b>	Quad DP1.2, Fiber SFP input
<b>Input resolutions</b>	From NTSC up to 4K (4,096 x 2,160) refresh rates: 24hz to 120hz 4K/4KUHD (4096 x 2160/ 3860 x 2400) to 240hz WQXGA (2560 x 1600)
<b>Max. pixel clock</b>	600 MHz
<b>Software tools</b>	Projector Toolset + Android** app + iOS** app

<b>Control</b>	XLR wired + IR, RS232, Wifi** (opt), GSM** (opt)
<b>Network connection</b>	10/100 base-T, RJ-45 connection, Wifi** (optional)
<b>Power requirements</b>	120-160 V (reduced power) / 200-240V (+/- 10%), 20A, 50-60Hz
<b>Max. power consumption</b>	3750W
<b>Noise level (typical at 25°C/ 77°F)</b>	58dB(A)
<b>Operational ambient temperature</b>	0-40°C / 32°-104°F (reduce power >35°C)
<b>Operational humidity</b>	0-80% (non condens)
<b>Dissipation BTU</b>	12,795
<b>Dimensions (WxLxH)</b>	660 x 830 x 350 mm / 25.98 x 32.67 x 13.77 inches
<b>Shipping Dimensions</b>	(WxLxH) 800 x 1,200 x 685 mm / 31.49 x 47.24 x 26.96 inches
<b>Weight</b>	92kg (202 lbs)/shipping weight from factory: 110kg (242 lbs)
<b>Standard accessories</b>	Power cord, wireless/XLR wired rugged remote control
<b>Certifications</b>	Compliant with UL60950-1 and EN60950-1 complies with FCC rules & regulations, part 15 Class A and CE EN55032 Class A, Rohs
<b>Warranty</b>	3 years

## A.9 Specifications of the UDX-U32

### Specifications

<b>Projector type</b>	UXGA 3-chip DLP digital projector
<b>Technology</b>	0.96" DMD™ x3
<b>Resolution</b>	1,600 x 1,200
<b>Brightness</b>	30,000 center lumens* / 29,000 ansi lumen / 32,000 ISO
<b>Contrast ratio</b>	2,000:1
<b>Brightness uniformity</b>	95%
<b>Aspect ratio</b>	4:3
<b>ScenergiX</b>	Horizontal and vertical edge blending
<b>Lenses</b>	TLD+ 0.37, 0.65-0.85, 0.73:1 ; 1.2:1 ; 0.8-1.16 ; 1.25-1.6:1 ; 1.5-2.0:1 ; 2.0-2.8:1 ; 2.8-4.5:1 ; 4.5-7.5:1 ; 7.5-11.5:1
<b>Optical lens shift</b>	Vertical between -100% to +130%, depending on lens Horizontal up to +/- 40%, depending on lens Motorized zoom and focus (with lens memory on TLD lenses) Motorized lens shift (with position memory on all lenses)
<b>Color correction</b>	P7
<b>Light source</b>	laser phosphor with inorganic phosphor wheel
<b>Light source lifetime</b>	25,000 hrs
<b>Optical dowser</b>	Digital
<b>Picture-in-picture</b>	Two sources simultaneously
<b>Sealed DLP™ core</b>	standard
<b>Orientation</b>	360°
<b>DMX 512</b>	standard
<b>WARP</b>	Direct adjust OSD + toolset
<b>Image processing</b>	Embedded warp & blend engine
<b>Keystone correction</b>	Yes
<b>Integrated web server</b>	Yes
<b>CLO (constant light output)</b>	Standard
<b>3D</b>	Active eye wear (optional), passive circular (optional); 2 flash up to 200Hz*
<b>Inputs</b>	Single HDBaseT; HDMI2.0 (HDCP2.2, HDR10); DP 1.2 (HDCP 1.3); Quad 3G/12G SDI / BarcoLink
<b>Optional Inputs</b>	Quad DP1.2
<b>Input resolutions</b>	From NTSC up to 4K (4,096 x 2,160) refresh rates: 24hz to 120hz 4K/4KUHD (4096 x 2160/ 3860 x 2400) to 240hz WQXGA (2560 x 1600)
<b>Max. pixel clock</b>	600 MHz
<b>Software tools</b>	Projector Toolset + Android** app + iOS** app

<b>Control</b>	XLR wired + IR, RS232, Wifi** (opt), GSM** (opt)
<b>Network connection</b>	10/100 base-T, RJ-45 connection, Wifi** (optional)
<b>Power requirements</b>	120-160V (reduced power) / 200-240V (+/- 10%), 20A, 50-60Hz
<b>Max. power consumption</b>	2,900W nom/3,100W max / STBY less than 10W
<b>Noise level (typical at 25°C/ 77°F)</b>	52dB(A)
<b>Operational ambient temperature</b>	0-40°C / 32°-104°F
<b>Operational humidity</b>	0-80% (non condens)
<b>Dissipation BTU</b>	Max. 9,895 BTU/h
<b>Dimensions (WxLxH)</b>	660 x 830 x 350 mm / 25.98 x 32.7 x 13.78 inches
<b>Shipping Dimensions</b>	(WxLxH) 800 x 1,200 x 685 mm / 31.49 x 47.24 x 26.96 inches
<b>Weight</b>	92 kg (202 lbs)/shipping weight from factory: 110 kg (242 lbs)
<b>Standard accessories</b>	Power cord, wireless/XLR wired rugged remote control, bottom rigging kit/ clamps
<b>Certifications</b>	Compliant with UL60950-1 and EN60950-1, complies with FCC rules & regulations, part 15 Class A and CE EN55032 Class A, Rohs
<b>Warranty</b>	3 years
<b>*</b>	+/- 10%

## A.10 Dimensions of a UDX

### Overview

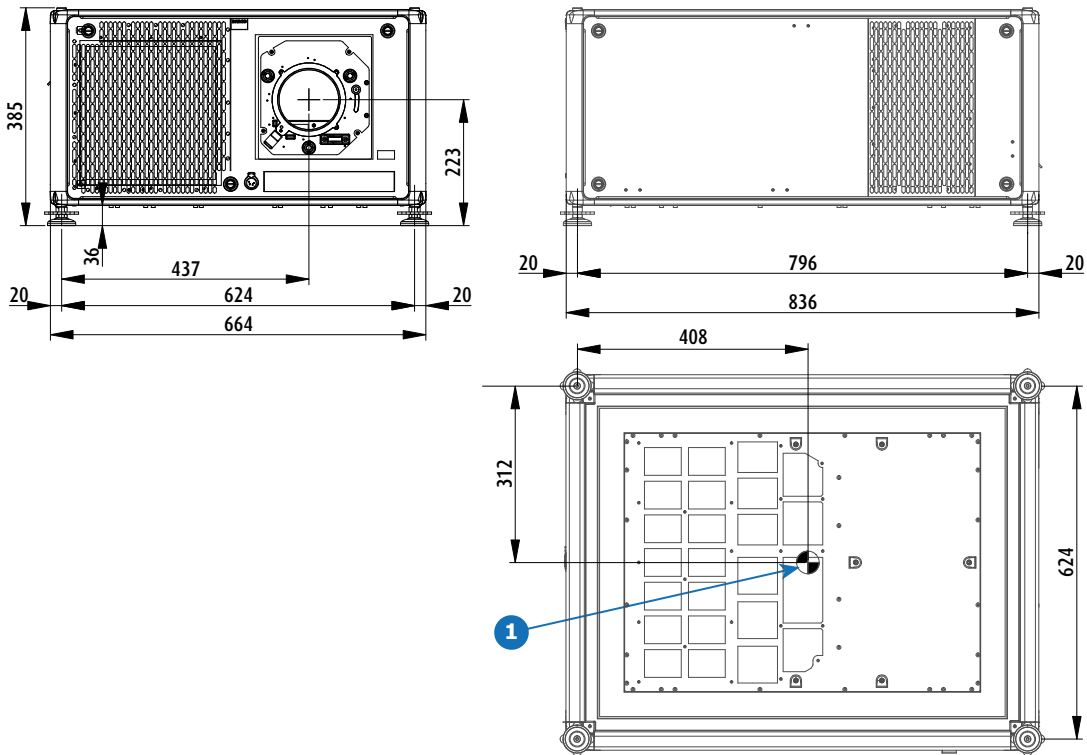

Image A-1: Dimensions, in mm

1 Geometrical centre

# A.11 Dimensions of the rigging frame

## Overview

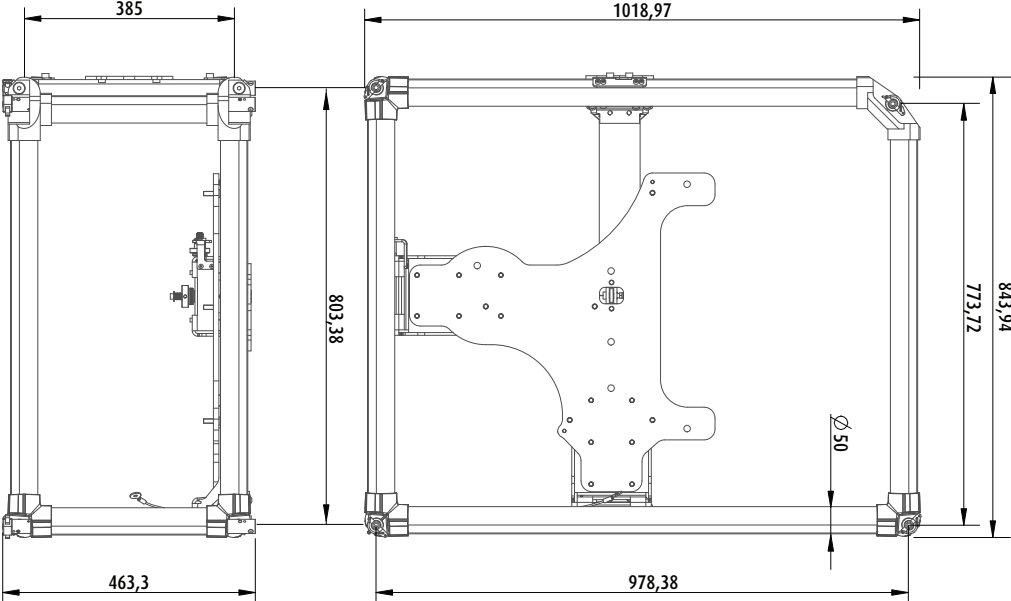

Image A-2: Dimensions, in mm

## A.12 Dimensions of the flight case

### Overview

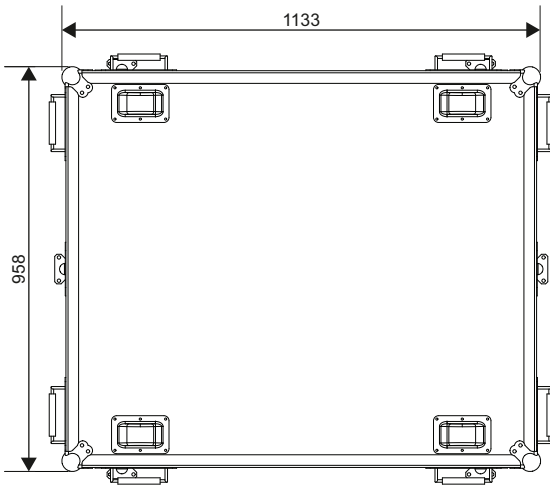
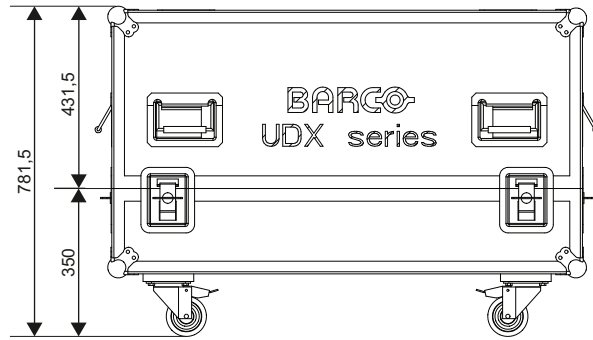

Image A-3: Dimensions, in mm





## A.13 Technical Regulations

### Certificates



Image A-4:  
EAC mark



Image A-5: CE  
mark



Image A-6:  
CCC mark



Image A-7:  
CEBEC  
mark



Image A-8: FCC  
label



Image A-9:  
RCM mark



Image A-10:  
SGS mark



# Environmental information

# B

## Overview

- Disposal information
- Turkey RoHS compliance
- Contact information

## B.1 Disposal information

### Disposal Information

Waste Electrical and Electronic Equipment



■ This symbol on the product indicates that, under the European Directive 2012/19/EU governing waste from electrical and electronic equipment, this product must not be disposed of with other municipal waste. Please dispose of your waste equipment by handing it over to a designated collection point for the recycling of waste electrical and electronic equipment. To prevent possible harm to the environment or human health from uncontrolled waste disposal, please separate these items from other types of waste and recycle them responsibly to promote the sustainable reuse of material resources.

For more information about recycling of this product, please contact your local city office or your municipal waste disposal service.

For details, please visit the Barco website at: <http://www.barco.com/AboutBarco/weee>

### Disposal of batteries in the product



This product contains batteries covered by the Directive 2006/66/EC which must be collected and disposed of separately from municipal waste.

If the battery contains more than the specified values of lead (Pb), mercury (Hg) or cadmium (Cd), these chemical symbols will appear below the crossed-out wheeled bin symbol.

By participating in separate collection of batteries, you will help to ensure proper disposal and to prevent potential negative effects on the environment and human health.

## B.2 Turkey RoHS compliance

### Turkey RoHS compliance



■ Türkiye Cumhuriyeti: AEEE Yönetmeliğine Uygundur.

[Republic of Turkey: In conformity with the WEEE Regulation]

## B.3 Contact information

### **Barco contact information**

Registered office address: President Kennedypark 35, 8500 Kortrijk, Belgium

Contact address: Beneluxpark 21, 8500 Kortrijk, Belgium

### **Importers contact information**

To find your local importer, contact Barco directly or one of Barco's regional offices via the contact information given on Barco's web site, [www.barco.com](http://www.barco.com).

# Overview video timings for video interfaces



## Overview

- Overview video timings
- Overview video timings SDI Inputs
- Overview video timings HDMI 2.0 inputs
- Overview video timings DisplayPort 1.2 inputs
- Overview video timings HDBaseT inputs

## C.1 Overview video timings

### List of compatible signals

The following table specifies the video signals that the projector can project. Barco Events projectors supports the signal with “X” in the Compatible signals column.

**Note:** Support for refresh rates 24.00, 30.00, 60.00 Hz automatically includes support of 1/1.001 x those refresh rates.

Resolution	Vertical refresh rate (Hz)	Compatible signal				
		HDMI 2.0 Inputs	12G SDI Input on Mk II Input board & Fiber Network Inputs	3G SDI Inputs	DisplayPort 1.2 Inputs	HDBaseT & HDMI 1.4 Inputs
640 x 480	60	X	—	—	X	X
720 x 480	60	X	—	—	—	X
720 x 576	50	X	—	—	—	X
800 x 600	60	X	—	—	X	X
1024 x 768	60	X	—	—	X	X
1280 x 720	24	—	X	X	—	—
1280 x 720	25	—	X	X	—	—
1280 x 720	30	—	X	X	—	—
1280 x 720	50	X	X	X	X	X
1280 x 720	60	X	X	X	X	X
1280 x 800	60	X	—	—	X	X
1280 x 960	60	X	—	—	X	X
1280 x 1024	60	X	—	—	X	X
1400 x 1050	60	X	—	—	X	X
1600 x 1200	60	X	—	—	X	X
1600 x 1200	120	—	—	—	X	—
1920 x 1080	24	X	X	X	X	X
1920 x 1080	25	X	X	X	—	X
1920 x 1080	30	X	X	X	—	X
1920 x 1080	50	X	X	X	X	X
1920 x 1080	60	X	X	X	X	X
1920 x 1080	120	—	—	—	X	—
1920 x 1200	50	X	X	X	X	X
1920 x 1200	60	X	X	X	X	X
1920 x 1200	120	—	—	—	X	—
2048 x 1080	24	X	—	—	X	X
2048 x 1080	25	X	—	—	X	X
2048 x 1080	30	X	—	—	X	X



Resolution	Vertical refresh rate (Hz)	Compatible signal				
		HDMI 2.0 Inputs	12G SDI Input on Mk II Input board & Fiber Network Inputs	3G SDI Inputs	DisplayPort 1.2 Inputs	HDBaseT & HDMI 1.4 Inputs
2048 x 1080	48	X	—	—	X	X
2048 x 1080	50	X	X	X	X	X
2048 x 1080	60	X	X	X	X	X
2048 x 1080	120	—	—	—	X	—
2560 x 1600	50	X	—	—	X	X
2560 x 1600	60	X	—	—	X	X
2560 x 1600	120	—	—	—	X	—
3840 x 2160	24	X	—	—	X	X
3840 x 2160	25	X	—	—	X	X
3840 x 2160	30	X	—	—	X	X
3840 x 2160	50	X	X	—	X	—
3840 x 2160	60	X	X	—	X	—
3840 x 2400	50	X	—	—	X	—
3840 x 2400	60	X	—	—	X	—
4096 x 2160	24	X	—	—	X	X
4096 x 2160	25	X	—	—	X	X
4096 x 2160	30	X	—	—	X	X
4096 x 2160	50	X	X	—	X	—
4096 x 2160	60	X	X	—	X	—

## C.2 Overview video timings SDI Inputs

### Overview

The following standard video formats are available for the projector.

Video timing (active pixels x active lines)	Vertical refresh rate (Hz) <sup>9</sup>	Type	Port Type
1280 x 720	24	HD-SDI	Single Link & Quad Link
1280 x 720	25	HD-SDI	Single Link & Quad Link
1280 x 720	30	HD-SDI	Single Link & Quad Link
1280 x 720	50	HD-SDI	Single Link & Quad Link
1280 x 720	60	HD-SDI	Single Link & Quad Link
1920 x 1080	24	HD-SDI	Single Link & Quad Link
1920 x 1080	25	HD-SDI	Single Link & Quad Link
1920 x 1080	30	HD-SDI	Single Link & Quad Link
1920 x 1080	50	3G-SDI	Single Link & Quad Link
1920 x 1080	60	3G-SDI	Single Link & Quad Link
1920 x 1200	50	3G-SDI "BarcoLink"	Single Link & Quad Link
1920 x 1200	59.94	3G-SDI "BarcoLink"	Single Link & Quad Link
1920 x 1200	60	3G-SDI "BarcoLink"	Single Link & Quad Link
2048 x 1080	50	3G-SDI	Single Link & Quad Link
2048 x 1080	60	3G-SDI	Single Link & Quad Link
3840 x 2160	50	12G-SDI <sup>10</sup>	Single Link
3840 x 2160	60	12G-SDI <sup>10</sup>	Single Link
3840 x 2400	50	12G-SDI "BarcoLink 4k" <sup>10</sup>	Single Link
3840 x 2400	59.94	12G-SDI "BarcoLink 4k" <sup>10</sup>	Single Link
3840 x 2400	60	12G-SDI "BarcoLink 4k" <sup>10</sup>	Single Link
4096 x 2160	50	12G-SDI <sup>10</sup>	Single Link
4096 x 2160	60	12G-SDI <sup>10</sup>	Single Link

9: Support for refresh rates 24.00, 30.00 and 60.00 Hz automatically includes support of 1/1.001 x those refresh rates.

10: 12G SDI board only, and only on Channel A

## C.3 Overview video timings HDMI 2.0 inputs

### Overview

The following standard video formats are available for the projector.

**Note:** support for refresh rates 24.00, 30.00, 60.00 Hz automatically includes support of 1/1.001 x those refresh rates

Video timing (active pixels x active lines)	Vertical refresh rate (Hz)	3D support?
640 x 480	60	
720 x 480	60	
720 x 576	50	
800 x 600	60	
1024 x 768	60	
1280 x 720	50	Frame packing Top – bottom
1280 x 720	60	Frame packing Top – bottom
1280 x 800	60	
1280 x 960	60	
1280 x 1024	60	
1400 x 1050	60	
1600 x 1200	60	
1920 x 1080	24	Frame packing Top – bottom
1920 x 1080	25	
1920 x 1080	30	
1920 x 1080	50	Side by Side (SbS) progressive
1920 x 1080	60	Side by Side (SbS) progressive
1920 x 1200	50	
1920 x 1200	60	
2048 x 1080	24	
2048 x 1080	25	
2048 x 1080	30	
2048 x 1080	48	
2048 x 1080	50	
2048 x 1080	60	
2560 x 1600	50	
2560 x 1600	60	
3840 x 2160	24	
3840 x 2160	25	
3840 x 2160	30	

<b>Video timing (active pixels x active lines)</b>	<b>Vertical refresh rate (Hz)</b>	<b>3D support?</b>
3840 x 2160	50	
3840 x 2160	60	
3840 x 2400	50	
3840 x 2400	60	
4096 x 2160	24	
4096 x 2160	25	
4096 x 2160	30	
4096 x 2160	50	
4096 x 2160	60	

## C.4 Overview video timings DisplayPort 1.2 inputs

### Overview

The following standard video formats are available for the projector.

**Note:** support for refresh rates 24.00, 30.00, 60.00 Hz automatically includes support of 1/1.001 x those refresh rates

Video timing (active pixels x active lines)	Vertical refresh rate (Hz)	Available layout modes, other than standard layout (1 x 1 layout) <sup>11</sup>	Support for 3D?
640 x 480	60		
800 x 600	60		
960 x 1080	120	4 Quadrant mode (2 x 2 layout)	Active 3D
960 x 1200	120	4 Quadrant mode (2 x 2 layout)	Active 3D
960 x 2160	120	4 Column mode (4 x 1 layout)	Active 3D
960 x 2400	120	4 Column mode (4 x 1 layout)	Active 3D
1024x 768	60		
1024 x 2160	60	4 Column mode (4 x 1 layout)	
1024 x 2160	120	4 Column mode (4 x 1 layout)	Active 3D
1280 x 720	50		
1280 x 720	60		
1280 x 800	60		
1280 x 960	60		
1280 x 1024	60		
1280 x 1080	60	4 Quadrant mode (2 x 2 layout)	
1280 x 1080	120	4 Quadrant mode (2 x 2 layout)	Active 3D
1280 x 1600	60	4 Quadrant mode (2 x 2 layout)	
1280 x 1600	120	4 Quadrant mode (2 x 2 layout)	Active 3D
1400 x 1050	60		
1600 x 1200	60		
1600 x 1200	120		Active 3D
1920 x 1080	50		
1920 x 1080	60		

<sup>11</sup>: Other layout modes are only available on Input boards that have multiple DP inputs.

<b>Video timing (active pixels x active lines)</b>	<b>Vertical refresh rate (Hz)</b>	<b>Available layout modes, other than standard layout (1 x 1 layout)<sup>11</sup></b>	<b>Support for 3D?</b>
1920 x 1080	120	4 Quadrant mode (2 x 2 layout)	Active 3D
1920 x 1200	50		
1920 x 1200	60		
1920 x 1200	120	4 Quadrant mode (2 x 2 layout)	Active 3D
1920 x 2160	60	2 Column mode (2 x 1 layout)	Passive stereo
1920 x 2160	120	2 Column mode (2 x 1 layout)	Active 3D
1920 x 2400	60	2 Column mode (2 x 1 layout)	
2048 x 1080	24		
2048 x 1080	25		
2048 x 1080	30		
2048 x 1080	48		
2048 x 1080	50		
2048 x 1080	60		
2048 x 1080	120	4 Quadrant mode (2 x 2 layout)	Active 3D
2048 x 2160	60	2 Column mode (2 x 1 layout)	
2048 x 2160	120	2 Column mode (2 x 1 layout)	Active 3D
2560 x 1080	120		Active 3D
2560 x 1440	120		Active 3D
2560 x 1600	50		
2560 x 1600	60		
2560 x 1600	120		
3840 x 2160	24		
3840 x 2160	25		
3840 x 2160	30		
3840 x 2160	50		
3840 x 2160	60		Passive Stereo
3840 x 2400	50		
3840 x 2400	60		
4096 x 2160	24		
4096 x 2160	25		

<sup>11</sup>: Other layout modes are only available on Input boards that have multiple DP inputs.

<b>Video timing (active pixels x active lines)</b>	<b>Vertical refresh rate (Hz)</b>	<b>Available layout modes, other than standard layout (1 x 1 layout)<sup>11</sup></b>	<b>Support for 3D?</b>
4096 x 2160	30		
4096 x 2160	50		
4096 x 2160	60		

11: Other layout modes are only available on Input boards that have multiple DP inputs.

## C.5 Overview video timings HDBaseT inputs

### Overview

The following standard video formats are available for the projector.

**Note:** support for refresh rates 24.00, 30.00, 60.00 Hz automatically includes support of 1/1.001 x those refresh rates.

<b>Video timing (active pixels x active lines)</b>	<b>Vertical refresh rate (Hz)</b>	<b>Available layout modes, other than standard layout (1 x 1 layout)</b>
640 x 480	60	
720 x 480	60	
720 x 576	50	
800 x 600	60	
1024 x 768	60	
1280 x 720	50	
1280 x 720	60	
1280 x 800	60	
1280 x 960	60	
1280 x 1024	60	
1400 x 1050	60	
1600 x 1200	60	
1920 x 1080	24	
1920 x 1080	25	
1920 x 1080	30	
1920 x 1080	50	
1920 x 1080	60	
1920 x 1200	50	
1920 x 1200	60	
1920 x 2160	50	2 Column mode (2 x 1 layout)
1920 x 2160	60	2 Column mode (2 x 1 layout)
2048 x 1080	24	
2048 x 1080	25	
2048 x 1080	30	
2048 x 1080	48	
2048 x 1080	50	
2048 x 1080	60	
2048 x 2160	50	2 Column mode (2 x 1 layout)
2048 x 2160	60	2 Column mode (2 x 1 layout)
2560 x 1600	50	
2560 x 1600	60	
3840 x 2160	24	



<b>Video timing (active pixels x active lines)</b>	<b>Vertical refresh rate (Hz)</b>	<b>Available layout modes, other than standard layout (1 x 1 layout)</b>
3840 x 2160	25	
3840 x 2160	30	
4096 x 2160	24	
4096 x 2160	25	
4096 x 2160	30	



# DMX chart

# D

## Overview

- DMX chart input board positioning
- DMX chart, Basic
- DMX chart, Extended

## D.1 DMX chart input board positioning

### About the input boards

6 Input selection ranges are reserved in the DMX chart per input board location (named L1 and L2). With the current version of DMX support, it is important to take into account to keep the input boards in their original slots.

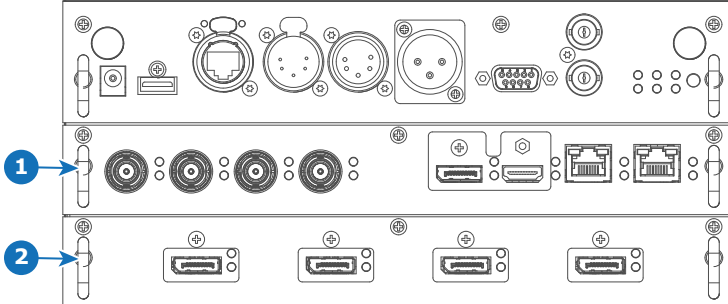

Image D-1

- 1 Slot L1, here filled with the Quad combo Input board
- 2 Slot L2, here filled with the Quad DP 1.2 Input board

## D.2 DMX chart, Basic

### Overview

Channel	Function	Value	Default	Action
1	Shutter + Intensity	0 - 7	255	Close shutter
		8 - 255		Adjust intensity
2	Function select	0 - 7	0	No function
		8 - 15		Activate first profile preset (If held for 1 second)
		16 - 23		Activate second profile preset (If held for 1 second)
		24 - 31		Activate third profile preset (If held for 1 second)
		32 - 39		Activate fourth profile preset (If held for 1 second)
		40 - 47		Activate fifth profile preset (If held for 1 second)
		48 - 55		Activate sixth profile preset (If held for 1 second)
		56 - 63		Activate seventh profile preset (If held for 1 second)
		64 - 71		Activate eighth profile preset (If held for 1 second)
		72 - 79		Activate ninth profile preset (If held for 1 second)
		80 - 87		Activate tenth profile preset (If held for 1 second)
		88 - 95		Select input 1: HDMI Input (If held for 1 second) <sup>12</sup>
		96 - 103		Select input 2: DisplayPort Input (If held for 1 second) <sup>12</sup>
		104 - 111		Select input 3: SDI Input A (If held for 1 second) <sup>12</sup>
		112 - 119		Select input 4: SDI Input B (If held for 1 second) <sup>12</sup>
		120 - 127		Select input 5: HDBaseT Input 1 (if held for 1 second) <sup>12</sup>
		128 - 135		Select input 6: Quad SDI input (if held for 1 second) <sup>12</sup>
		136 - 143		Select input 7: Quad DP board Input A (if held for 1 second) <sup>13</sup>
		144 - 151		Select input 8: Quad DP board Input B (if held for 1 second) <sup>13</sup>
		152 - 159		Select input 9: Quad DP board Input C (if held for 1 second) <sup>13</sup>
		160 - 167		Select input 10: Quad DP board Input D (if held for 1 second) <sup>13</sup>
		168 - 175		Select input 11: Quad DP board Inputs A-B (if held for 1 second) <sup>13</sup>
176 - 183	Select input 12: Quad DP board quad column mode (if held for 1 second) <sup>13</sup>			
184 - 207	Reserved for future functionality			
208 - 115	Power on / Light source on (If held for 5 seconds)			
216 - 223	Power down / Light source off (if held for 5 seconds)			
224 - 255	Reserved for future functionality			

12: Only when the Quad Combo input board is installed in slot L1

13: Only when the Quad DisplayPort input board is installed in slot L2

## D.3 DMX chart, Extended

### Overview

Channel	Function	Value	Default	Actions
1	Shutter + Intensity	0 - 7	255	Close shutter
		8 - 255		Adjust intensity
2	Brightness	0 - 255	128	Adjusts the brightness between 0 and 100% on input.
3	Contrast	0 - 255	128	Adjusts the contrast between 0 and 100% on input
4	Input selection	0 - 7	0	No function
		8 - 15		Activate first profile preset (If held for 1 second)
		16 - 23		Activate second profile preset (If held for 1 second)
		24 - 31		Activate third profile preset (If held for 1 second)
		32 - 39		Activate fourth profile preset (If held for 1 second)
		40 - 47		Activate fifth profile preset (If held for 1 second)
		48 - 55		Activate sixth profile preset (If held for 1 second)
		56 - 63		Activate seventh profile preset (If held for 1 second)
		64 - 71		Activate eighth profile preset (If held for 1 second)
		72 - 79		Activate ninth profile preset (If held for 1 second)
		80 - 87		Activate tenth profile preset (If held for 1 second)
		88 - 95		Select input 1: HDMI Input (If held for 1 second) <sup>12</sup>
		96 - 103		Select input 2: DisplayPort Input (If held for 1 second) <sup>12</sup>
		104 - 111		Select input 3: SDI Input A (If held for 1 second) <sup>12</sup>
		112 - 119		Select input 4: SDI Input B (If held for 1 second) <sup>12</sup>
		120 - 127		Select input 5: HDBaseT Input 1 (if held for 1 second) <sup>12</sup>
		128 - 135		Select input 6: Quad SDI input (if held for 1 second) <sup>12</sup>
		136 - 143		Select input 7: Quad DP board Input A (if held for 1 second) <sup>13</sup>
		144 - 151		Select input 8: Quad DP board Input B (if held for 1 second) <sup>13</sup>
		152 - 159		Select input 9: Quad DP board Input C (if held for 1 second) <sup>13</sup>
160 - 167	Select input 10: Quad DP board Input D (if held for 1 second) <sup>13</sup>			
168 - 175	Select input 11: Quad DP board Inputs A-B (if held for 1 second) <sup>13</sup>			
176 - 183	Select input 12: Quad DP board quad column mode (if held for 1 second) <sup>13</sup>			
184 - 255	Reserved for future functionality			
5	Focus (MSB)	0 - 255	128	Set coarse lens focus adjustment <sup>14</sup>
6	Focus (LSB)	0 - 255	128	Set fine lens focus adjustment <sup>14</sup>
7	Zoom (MSB)	0 - 255	128	Set coarse lens zoom adjustment <sup>14</sup>
8	Zoom (LSB)	0 - 255	128	Set fine lens zoom adjustment <sup>14</sup>
9	Lens shift vertical (MSB)	0 - 255	128	Set coarse lens shift in vertical direction
10	Lens shift vertical (LSB)	0 - 255	128	Set fine lens shift in vertical direction
11	Lens shift horizontal (MSB)	0 - 255	128	Set coarse lens shift in horizontal direction
12	Lens shift horizontal (LSB)	0 - 255	128	Set fine lens shift in horizontal direction

<sup>14</sup>: Only when lens has been calibrated

Channel	Function	Value	Default	Actions
13	Light Source Power <sup>15</sup>	0 - 3	0	Set light source to 100%
		4 - 7		Set light source to 95%
		8 - 11		Set light source to 90%
		12 - 15		Set light source to 85%
		16 - 20		Set light source to 80%
		21 - 23		Set light source to 75%
		24 - 27		Set light source to 70%
		28 - 31		Set light source to 65%
		32 - 35		Set light source to 60%
		36 - 39		Set light source to 55%
		40 - 43		Set light source to 50%
		44 - 47		Set light source to 45%
		48 - 51		Set light source to 40%
		52 - 55		Set light source to 35%
		56 - 59		Set light source to 30%
		60 - 63		Set light source to 25%
		64 - 67		Set light source to 20%
		68 - 71		Set light source to 15%
		72 - 75		Set light source to 10%
		76 - 79		Reserved for future functionality
80 - 87	Power on / Light source on (If held for 5 seconds)			
88 - 95	Power down / Light source off (if held for 5 seconds)			
96 - 255	Reserved for future functionality			
14	Various	0 - 7	0	Reserved for future functionality
		8 - 15		Calibrate lens zoom & focus (if held for 5 seconds)
		16 - 23		Calibrate lens horizontal and vertical shift (if held for 5 seconds)
		24 - 31		Calibrate lens (zoom, focus and shift)
		32 - 255		Reserved for future functionality

15: If the Light Source is forced to a output below its minimum value, it will remain at its minimum output value

