

## USER MANUAL

### MODEL:

VS-88UT

8x8 HDMI/HDBT Matrix Switcher

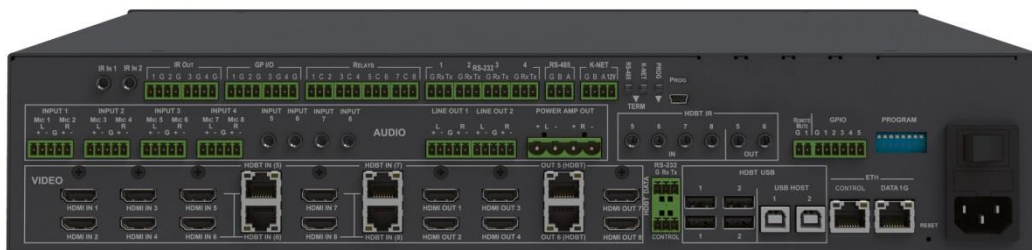
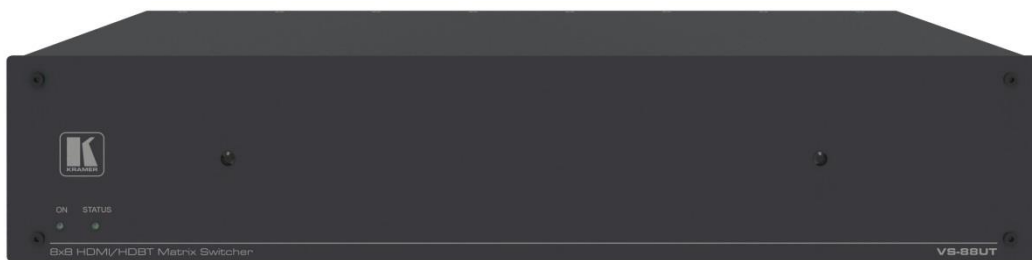

# Contents

<b>Introduction</b>	<b>1</b>
Getting Started	1
Overview	2
Typical Applications	4
Controlling your VS-88UT	4
<b>Defining the VS-88UT 8x8 HDMI/HDBT Matrix Switcher</b>	<b>5</b>
<b>Installing in a Rack</b>	<b>8</b>
<b>Connecting the VS-88UT</b>	<b>9</b>
Connect the Matrix Ports	9
Connect the Controller Ports	11
Connecting the Audio Inputs and Outputs	12
Connecting to VS-88UT via RS-232	13
Connecting VS-88UT via the Ethernet Port	13
<b>Using the Web Pages</b>	<b>17</b>
<b>Global Mute Feature</b>	<b>19</b>
<b>Defining General Settings</b>	<b>20</b>
<b>Routing VS-88UT Ports</b>	<b>23</b>
Defining Port Settings	24
<b>Controlling Devices via the Controller</b>	<b>54</b>
Room Controller Configuration via K-Config 3	55
Controlling Devices	57
Activating Macros	62
Scheduling Macros	63
Setting the Date and Time	65
<b>Managing EDID</b>	<b>66</b>
<b>Changing the Device Settings</b>	<b>70</b>
Resetting to Factory Default Parameters	70
Performing Firmware Upgrade	71
Setting Authentication	72
<b>Setting Network Parameters</b>	<b>74</b>
Changing the Ethernet Settings	74
<b>Viewing the About Page</b>	<b>76</b>
<b>Technical Specifications</b>	<b>77</b>
Default Communication Parameters	79
<b>Protocol 3000</b>	<b>80</b>
Understanding Protocol 3000	81
Kramer Protocol 3000 Syntax	81
Extended Protocol 3000	82
Other Rules	85
Protocol 3000 Commands	86

# Introduction

Welcome to Kramer Electronics! Since 1981, Kramer Electronics has been providing a world of unique, creative, and affordable solutions to the vast range of problems that confront the video, audio, presentation, and broadcasting professional on a daily basis. In recent years, we have redesigned and upgraded most of our line, making the best even better!

Our 1,000-plus different models now appear in 14 groups that are clearly defined by function: GROUP 1: Distribution Amplifiers; GROUP 2: Switchers and Routers; GROUP 3: Control Systems; GROUP 4: Format/Standards Converters; GROUP 5: Range Extenders and Repeaters; GROUP 6: Specialty AV Products; GROUP 7: Scan Converters and Scalers; GROUP 8: Cables and Connectors; GROUP 9: Room Connectivity; GROUP 10: Accessories and Rack Adapters; GROUP 11: Sierra Video Products; GROUP 12: Digital Signage; GROUP 13: Audio; and GROUP 14: Collaboration.

---

## Getting Started

We recommend that you:

- Unpack the equipment carefully and save the original box and packaging materials for possible future shipment.
- Review the contents of this user manual.



Go to [www.kramerav.com/downloads/VS-88UT](http://www.kramerav.com/downloads/VS-88UT) to check for up-to-date user manuals, application programs, and to check if firmware upgrades are available (where appropriate).

## Achieving the Best Performance

- Use only good quality connection cables (we recommend Kramer high-performance, high-resolution cables) to avoid interference, deterioration in signal quality due to poor matching, and elevated noise levels (often associated with low quality cables).
- Do not secure the cables in tight bundles or roll the slack into tight coils.
- Avoid interference from neighbouring electrical appliances that may adversely influence signal quality.
- Position your Kramer **VS-88UT** away from moisture, excessive sunlight and dust.



This equipment is to be used only inside a building. It may only be connected to other equipment that is installed inside a building.

## Safety Instructions



- Caution: There are no operator serviceable parts inside the unit.
- Warning: Use only the power cord that is supplied with the unit.
- Warning: Do not open the unit. High voltages can cause electrical shock! Servicing by qualified personnel only.
- Warning: Disconnect the power and unplug the unit from the wall before installing.

## Recycling Kramer Products

The Waste Electrical and Electronic Equipment (WEEE) Directive 2002/96/EC aims to reduce the amount of WEEE sent for disposal to landfill or incineration by requiring it to be collected and recycled. To comply with the WEEE Directive, Kramer Electronics has made arrangements with the European Advanced Recycling Network (EARN) and will cover any costs of treatment, recycling and recovery of waste Kramer Electronics branded equipment on arrival at the EARN facility. For details of Kramer's recycling arrangements in your particular country go to our recycling pages at [www.kramerav.com/support/recycling](http://www.kramerav.com/support/recycling).

---

## Overview

Congratulations on purchasing your Kramer **VS-88UT 8x8 HDMI/HDBT Matrix Switcher**.

**VS-88UT** is a high-performance 4K@60Hz (4:2:0) Audio-Video presentation system with integrated range extension and an integrated control system master. The unit switches the video, embeds the audio and outputs the signal to both HDMI and HDBaseT 2.0 with USB extension and PoE on the output ports. Outstanding audio support includes balanced stereo audio, unbalanced stereo audio and embedded audio sources that output to embedded audio, balanced stereo audio as well as a power amplified audio output.

**VS-88UT** includes a master room controller that can operate over Ethernet (LAN) with control ports that include: one bidirectional RS-485, four RS-232, four IR, four GPI/O, and eight relays to control a wide variety of AV devices. It includes a KNET™ connector interface that enables access to the master controller from auxiliary room controllers such as control keypads. The unit can also provide power to auxiliary room controllers via the KNET™ connectors. The **VS-88UT** includes an Ethernet gateway to control and manage remote I/O ports.

The **VS-88UT** provides exceptional quality, advanced and user-friendly operation, and flexible control.

## Exceptional Quality

- Max. Data Rate – 10.2Gbps (3.4Gbps per graphic channel).
- Max. Resolution – 4K@60Hz (4:2:0).
- Audio Level control.
- HDMI, HDCP and DVI compliance.

- HDBaseT certified – V2.0 support.
- HDBaseT Extension Reach – Up to 100m at 4K @60Hz (4:2:0), up to 130m (430ft) at full HD (1080p @60Hz 36bpp), up to 180m (590ft) at ultra-mode and full HD (1080p @60Hz 24bpp).
- USB Support – USB 1.1 and USB 2.0 (up to 127Mbps) channelled through HDBaseT.
- HDMI Support – Deep color, 3D, ARC, 7.1 PCM.
- Kramer reKlocking™ and equalization technology – Rebuilds the digital signal to travel longer distances.

## Advanced and User-friendly Operation

- Advanced EDID management per input.
- Active source and acceptor detection.
- Control options – RS-232 serial commands transmitted by a PC, touch screen system or other serial controller, Ethernet port via LAN.
- Kramer K-Config™ Compatible – Windows®-based control program for easy configuration and upload to room controller over customer IP network.
- Kramer Network Compatible – Remote control and management over customer IP network.
- Simultaneous IP control communication – With up to 15 IP control clients.
- Auto-switching and auto-scanning of inputs.
- Audio breakaway and AFV (audio-follow-video) operation support.
- Global mute for both video and audio outputs – Allowing easy integration of the audio system with a public announcement audio system in case of an emergency event.
- Firmware Upgrade – Ethernet-based, via a user-friendly software upgrade tool.
- Kramer protocol 3000 support.
- Advanced EDID management per input.
- Includes non-volatile memory that retains the last settings after switching the power off and then on again.

## Flexible Connectivity

- 4 HDMI and 4 HDMI/HDBT (selectable) inputs.
- 4 balanced stereo audio inputs or 8 microphone inputs (selectable) as well as 4 unbalanced stereo inputs.
- 6 HDMI and 2 HDBT outputs.
- 2 line-out balanced stereo audio outputs and one audio amplified output.
- 2 USB type-A hubs and 2 USB Type-B ports.
- 6 IR ports for HDBT tunnelling.
- 1 Ethernet port – Connects to control gateways for I/O port extending, and controls IP-enabled controlled devices.

- 1G Ethernet port – For tunnelling data via HDBT ports
- 1 K-NET™ connector – Carrying both power and control communication; connects to room control system, either master room controller, or auxiliary control keypads.
- 1 RS-485 and 2 RS-232 bidirectional control ports – Control devices via bidirectional serial control protocols.
- 4 IR emitter control ports – Control devices via IR control protocols.
- 4 GPI/O control ports – Control devices via general purpose I/O ports, individually configurable as digital input, digital output or analog input interface for controlling sensors, door-locks, audio volume and light dim level, or lighting control devices.
- 8 Relay control ports – Control devices via relay contact closure, such as scrolling up and down screens, drapes, shades, and blinds.
- IR Sensor and IR input ports – Learn commands from IR remotes.

---

## Typical Applications

The VS-88UT is ideal for the following typical applications:

- Projection systems in conference rooms, boardrooms, hotels and churches.
- Divisible conference rooms in hotels.
- Classroom, lecture theatres and education applications.

---

## Controlling your VS-88UT

Control your VS-88UT via:

- By RS-232 serial commands transmitted by a touch screen system, PC, or other serial controller (see [Connecting to VS-88UT via RS-232](#) on page [13](#)).
- Ethernet using built-in user-friendly Web pages (see [Using the Web Pages](#) on page [17](#)).

# Defining the VS-88UT 8x8 HDMI/HDBT Matrix Switcher

This section defines the VS-88UT.

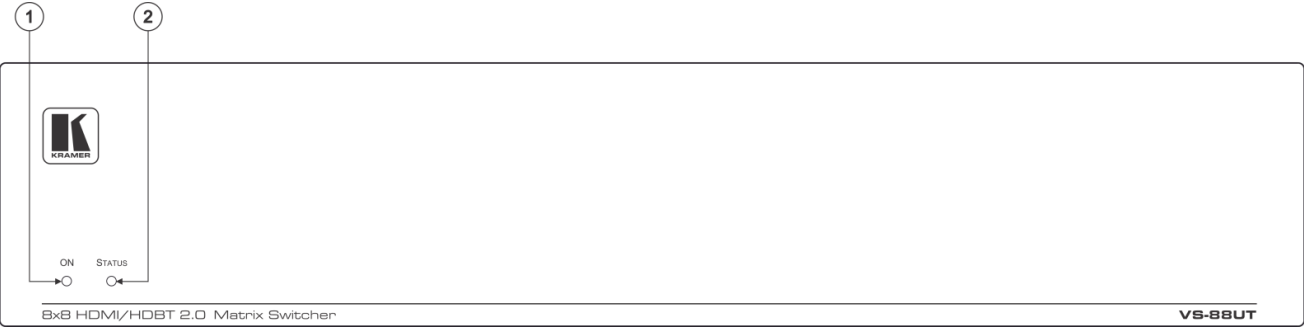

Figure 1: VS-88UT 8x8 HDMI/HDBT Matrix Switcher Front Panel

#	Feature	Function
1	ON LED	Lights when receiving power.
2	STATUS LED	Multi-color LED lights upon startup, flashes green upon boot and lights green when ready to use. The LED lights red to indicate internal errors.

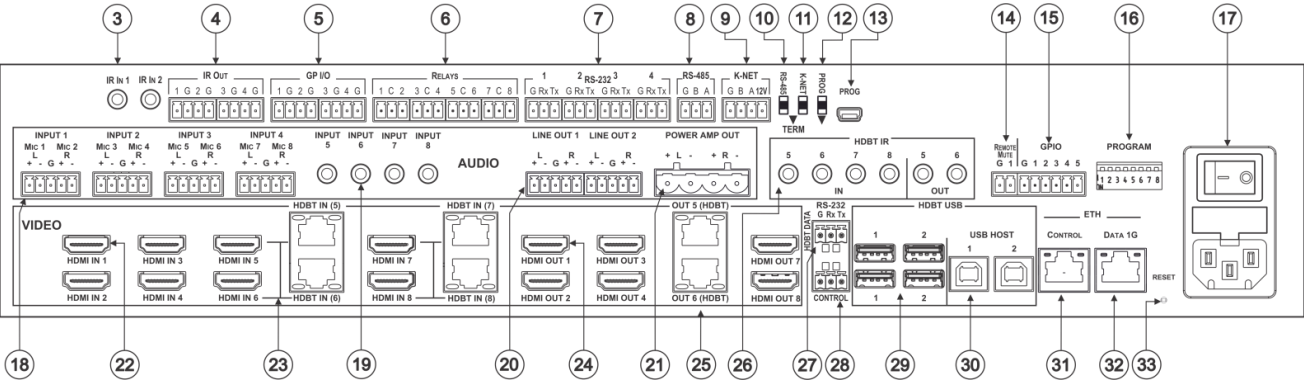

Figure 2: VS-88UT 8x8 HDMI/HDBT Matrix Switcher Rear Panel

#	Feature	Function
<b>Room Controller Functionality</b>		
3	IR IN 1 3.5mm Mini Jack	Connect to an external IR receiver (1 and 2).
4	IR OUT Terminal Block Connectors	Connect to IR emitter cables (from 1 to 4).
5	GPI/O Terminal Block Connectors	Connect to various analog and digital sensors (from 1 to 4).
6	RELAYS Terminal Block Connectors	Connect to low-voltage relay-driven devices (from 1 to 8).
7	RS-232 Terminal Block Connectors	Connect to RS-232 controlled devices (from 1 to 4).
8	RS-485 Terminal Block Connector	Connect to the RS-485 detachable terminal block on a switcher or PC. Pins B (-) and A (+) are for RS-485; Pin G may be connected to the shield (if required).
9	K-NET Terminal Block Connector	Use with the K-Config control system. PIN GND is for the Ground connection; PIN B (-) and PIN A (+) are for RS-485, and PIN +12V is for powering other devices.

#	Feature	Function	
⑩	RS-485 TERM Switch	Slide down for RS-485 termination with 120Ω; slide up for no RS-485 line termination. The first and the last units on the RS-485 line should be terminated (ON). Other units should not be terminated (OFF).	
⑪	K-NET TERM Switch	Use with the K-Config control system. Slide down (in the direction of the arrow) for K-NET termination; slide up for bus to not be terminated. The last physical device on a K-NET bus must be terminated.	
⑫	PROG Switch	For factory use only.	
⑬	PROG Mini USB Connector	For factory use only.	
<b>Matrix Functionality</b>			
⑭	REMOTE MUTE 2-pin Terminal Block Connector	Remote switch to mute all video and audio signals. Enables easy integration of the audio system with a PA systems, usually used for alarms or other public audio messages.	
⑮	GPIO Terminal Block Connectors	For future use.	
⑯	PROGRAM DIP-switches	For future use.	
⑰	Power Connector with Switch and Fuse	AC connector, enabling power supply to the unit. Power switch for turning the unit on or off.	
⑱	AUDIO INPUT (MIC/line) 5-pin Terminal Block Connectors	Connect to stereo audio balanced sources (from 1 to 4) and/or microphone inputs (from 1 to 8).	
⑲	INPUT 3.5mm Mini Jack	Connect to an unbalanced audio source (from 5 to 8).	
⑳	LINE OUT 5-pin Terminal Block Connectors	Connect to a stereo balanced audio acceptor (1 and 2).	
㉑	POWER AMP OUT 4-pin Terminal Block Connectors	Connect to a pair of loudspeakers.	
㉒	VIDEO HDMI IN Connector	Connect to an HDMI source (from 1 to 4).	
㉓	HDMI IN—HDBT IN Connectors	Connect a source to the HDMI IN 5 and/or HDMI IN 6 inputs, or connect a transmitter to the HDBT IN (5) and/or HDBT IN (6) inputs. The same applies to the HDMI IN 7/8 and HDBT IN (7)/(8) pairs. For each input pair (HDMI or HDBT), only one type of connector can be enabled (via the Routing Settings Web page); by default, the HDBT pair is active. The HDBT Transmitter (for example, the Kramer <b>TP-590Txr</b> ) can pass audio and video signals as well as USB, Ethernet, power and serial commands.	
㉔	HDMI OUT Connectors	Connect to an HDMI acceptor (1, 2, 3, 4, 7 and 8).	
㉕	OUT (HDBT) RJ-45 Connectors	Connect OUT 5 and/or OUT 6 to HDBT receivers (for example, the Kramer <b>TP-590Rxr</b> ) to pass audio and video signals as well as USB, Ethernet, power and serial commands.	
㉖	HDBT IR 3.5mm Mini Jack	IN	Connect to an external IR sensor to send IR signals (5, 6, 7 and 8) via HDBT inputs 5, 6, 7 and 8 respectively.
		OUT	Connect to an external IR emitter to receive IR signals (5 and 6) via HDBT outputs 5 and 6, respectively.
㉗	RS-232 HDBT DATA Terminal Block Connectors (G, Rx, Tx)	Connect to the PC or the remote controller and pass data between this RS-232 port and the HDBT OUT ports or one of the HDBT IN ports.	
㉘	RS-232 CONTROL Port Terminal Block Connectors (G, Rx, Tx)	Connect to the PC or the remote controller to control the <b>VS-88UT</b> via Protocol 3000 commands.	



#	Feature	Function	
29	HDBT USB Device Port Pairs	Connect up to two USB clients to each pair (1 and 2) to pass data via the HDBT inputs or outputs.	
30	HDBT USB HOST Ports	Connect to a USB host (1 and 2) to pass data via the HDBT inputs or outputs.	
31	ETH RJ-45 Ports	CONTROL	Connect to the PC or other controller through computer networking.
32		DATA 1G	Connect to The PC or other controller via the Ethernet to pass data between HDBT ports and the controller.
33	RESET Recessed Button	Press briefly to restart the system. Press for about 5 seconds to reset settings to factory default values and restart the system.	

# Installing in a Rack

This section provides instructions for rack mounting the **VS-88UT**. Before installing in a rack, verify that the environment is within the recommended range:

- Operation temperature – 0° to 40°C (32 to 104°F).
- Storage temperature – -40° to +70°C (-40 to +158°F).
- Humidity – 10% to 90%, RHL non-condensing.



**When installing on a 19" rack, avoid hazards by taking care that:**

- It is located within recommended environmental conditions. Operating ambient temperature of a closed or multi-unit rack assembly may exceed ambient room temperature.
- Once rack mounted, there is enough air still flow around the **VS-88UT**.
- The **VS-88UT** is placed upright in the correct horizontal position.
- You do not overload the circuit(s). When connecting the **VS-88UT** to the supply circuit, overloading the circuits may have a detrimental effect on overcurrent protection and supply wiring. Refer to the appropriate nameplate ratings for information. For example, for fuse replacement, see the value printed on the product label.
- The **VS-88UT** is earthed (grounded) and connected only to an electricity socket with grounding. Pay particular attention when electricity is supplied indirectly (for example, when the power cord is not plugged directly into the wall socket but to an extension cable or power strip). Use only the supplied power cord.

**To rack-mount the VS-88UT:**

1. Attach both rack ears to the **VS-88UT**:  
Remove the screws from each side of the **VS-88UT** (5 on each side), and replace them through the rack ears.
2. Place the rack ears of the **VS-88UT** against the rack rails and insert the appropriate screws (not provided) through each of the four holes in the rack ears.

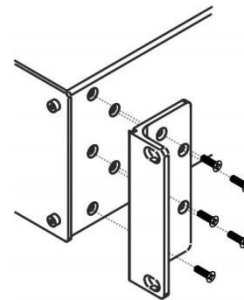

Some models, may feature built-in rack ears:

- Detachable rack ears can be removed for desktop use.
- Always mount the **VS-88UT** in the rack before connecting any cables or power.
- If you are using a Kramer rack adapter kit (for a machine that is not 19"), see the Rack Adapters user manual for installation instructions available from our Web site [www.kramerav.com/downloads/VS-88UT](http://www.kramerav.com/downloads/VS-88UT).

# Connecting the VS-88UT

This section describes how to:

- [Connect the Matrix Ports](#) on page [9](#).
- [Connect the Controller Ports](#) on page [11](#).



Always switch off the power to each device before connecting it to your **VS-88UT**. After connecting your **VS-88UT**, connect its power and then switch on the power to each device.



Note that not all the ports are connected in the following example.

---

## Connect the Matrix Ports

To connect the **VS-88UT** Matrix as illustrated in the example in [Figure 3](#):

1. Connect the HDMI and HDBT sources:

- An HDMI source (for example, a laptop) to the HDMI 1 IN connector [\(22\)](#).  
Alternatively, you can connect the DVI connector on the DVD player to the HDMI connector on the **VS-88UT** via a DVI-HDMI adapter.
- An HDMI source (for example, a Blu-ray player) to the HDMI 4 IN connector [\(22\)](#).
- An HDMI source (for example, a Blu-ray player) to the HDMI IN 8 HDMI connector [\(23\)](#).
- A transmitter (for example, the Kramer **TP-590Txr**) to the HDBT IN (8) RJ-45 port [\(23\)](#).



You can enable one of each HDMI and HDBT input pair (5, 6, 7 and 8) via the embedded web pages, see [Setting Input HDBT/HDMI Port Parameters](#) on page [33](#).

2. Connect the audio sources:

- An audio source (for example, the laptop audio output signal) to the AUDIO INPUT 1 balanced stereo analog audio 5-pin terminal block connector (1 to 4) [\(18\)](#).
- A microphone to the AUDIO MIC 4 balanced audio 3-pin terminal block connector (1 to 8) [\(18\)](#).



You can connect each AUDIO analog input 5-pin terminal block connector to either a balanced stereo audio analog source or to up to two microphones via the web pages, [Setting Analog Audio Input Port Parameters](#) on page [39](#).

- An audio source (for example, an MP3 player) to the AUDIO INPUT 5 analog audio 3.5mm mini jack connector (5 to 8) [\(19\)](#).

## 3. Connect the HDMI and HDBT outputs:

- The HDMI OUT 3 HDMI connector (1 to 4, 7 and 8) (24), to an HDMI acceptor (for example, a display).
- The OUT 6 (HDBT) RJ-45 port (5 to 6) (25) to a receiver (for example, the Kramer **TP-590Rxr**).

## 4. Connect the audio outputs:

- The AUDIO LINE OUT (1 to 2) Terminal Block connector (16) to a balanced audio acceptor (for example, active speakers).
- The POWER AMP OUT block connector (21) to a pair of loudspeakers, by connecting the left loudspeaker to the “L+” and the “L-” terminal block connectors, and the right loudspeaker to the “R+” and the “R-” terminal block connectors.



Do not ground the loudspeakers.

## 5. Connect the IR ports:

- HDBT IR IN 8 (5 to 8) 3.5mm mini jack (26) to a room controller (for example, the Kramer **RC-74DL**) to control a peripheral device, such as Blu-ray player that connects to the transmitter that is connected to HDBT IN (8).
- HDBT IR OUT 6 (5 to 6) 3.5mm mini jack (26) to an IR controlled device (for example, a Blu-ray player) So that it can be controlled by a controller that is connected to a receiver that connects to the OUT 6 (HDBT) port.

## 6. Connect the USB ports:

- A keyboard and a mouse to HDBT USB 2 ports (29).  
The USB signal passes via HDBT IN to a transmitter (for example TP-590Txr) where a laptop can be controlled.
- A laptop to USB HOST 1 port (30).  
A receiver (for example **TP-590Rxr**) connected to HDBT OUT controls this connected laptop.

## 7. Connect RS-232 3-pin terminal blocks:

- RS-232 HDBT DATA (27) – Connect to a laptop to control peripheral devices that are connected to transmitters/receivers that connect to the HDBT IN / HDBT OUT ports.
- RS-232 CONTROL (28) – Connect to a laptop to control **VS-88UT**.

## 8. Connect ETH ports:

- CONTROL (31) – Connect to a laptop to control **VS-88UT**.
- DATA 1G (32) – Connect to the Ethernet to pass data via the cloud.

## Connect the Controller Ports

To connect the VS-88UT Controller as illustrated in the example in [Figure 3](#):

1. Connect an IR sensor to IR IN 1 3.5mm mini jack (1 to 2) ③.  
For example, point an IR remote controller to the IR sensor to control a device that is connected to a controller port.
2. Connect the IR OUT 2-pin terminal block connector (1 to 4) ④ to an IR emitter and attach the emitter to a controlled device (for example, a display).
3. Connect the GPI/O 2-pin terminal block connector (1 to 4) ⑤ to an input/output device (for example, a motion detector).
4. Connect the RELAY 2-pin terminal block connector (1 to 8) ⑥ to a relay port (for example, a controlled screen).
5. Connect the RS-232 3-pin terminal block connector (1 to 4) ⑦ to a serially controlled device (for example, a projector).
6. Connect the RS-485 3-pin terminal block connector ⑧ to a controlled system (for example, a lighting system).
7. Connect the K-NET 4-pin terminal block connector ⑨ to a room controller (for example, the Kramer **RC-63DLN**).  
The room controller is powered via the 12V pin.
8. Set the TERM switches:
  - RS-485 TERM ⑩ – Slide down for termination.  
The first and the last units on the RS-485 line should be terminated (ON). Other units should not be terminated (OFF).
  - K-NET TERM ⑪ – Slide down for K-NET termination.  
The last physical device on a K-NET bus must be terminated.
9. Connect the power cord ⑰.  
We recommend that you use only the power cord that is supplied with this machine.

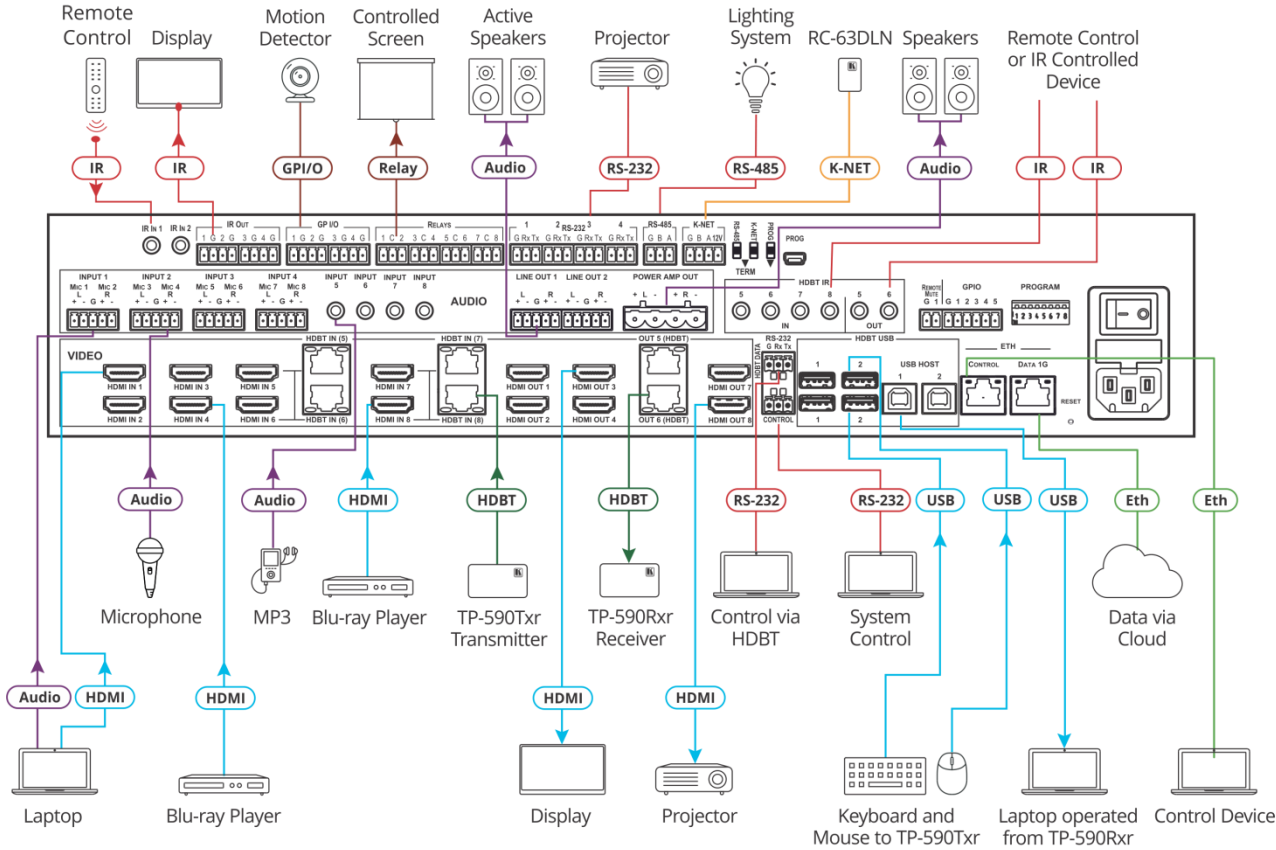

Figure 3: Connecting to the VS-88UT Rear Panel

## Connecting the Audio Inputs and Outputs

The following are the pinouts for connecting balanced or unbalanced stereo audio sources to the audio inputs:

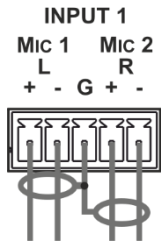

Figure 4: Connecting a Balanced Stereo Audio Source to the Input



Figure 5: Connecting an Unbalanced Stereo Audio Source to the Input

The following are the pinouts for connecting the audio outputs to balanced or unbalanced stereo audio acceptors:

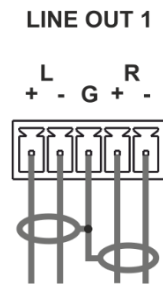

Figure 6: Connecting the Output to a Balanced Stereo Audio Acceptor

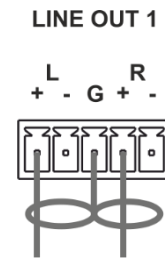

Figure 7: Connecting the Output to an Unbalanced Stereo Audio Acceptor

## Connecting to VS-88UT via RS-232

You can connect to the VS-88UT via an RS-232 connection (28) using, for example, a PC.

Connect the RS-232 terminal block on the rear panel of the VS-88UT to a PC/controller, as follows (see [Figure 8](#)):

- TX pin to Pin 2
- RX pin to Pin 3
- GND pin to Pin 5

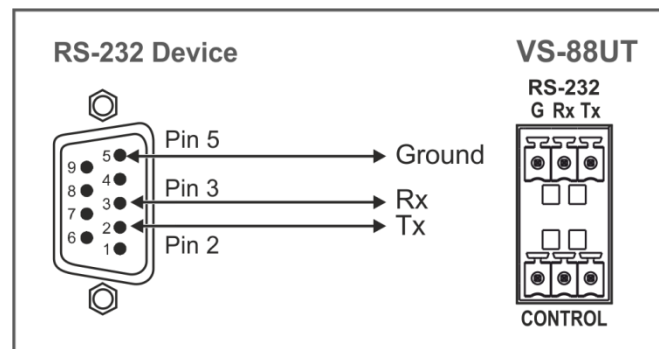

Figure 8: RS-232 Connection

## Connecting VS-88UT via the Ethernet Port

You can connect to the VS-88UT via Ethernet using either of the following methods:

- Directly to the PC using a crossover cable (see [Connecting the Ethernet Port Directly to a PC](#) on page [14](#)).
- Via a network hub, switch, or router, using a straight-through cable (see [Connecting the Ethernet Port via a Network Hub or Switch](#) on page [16](#)).



If you want to connect via a router and your IT system is based on IPv6, speak to your IT department for specific installation instructions

## Connecting the Ethernet Port Directly to a PC

You can connect the Ethernet port of the **VS-88UT** directly to the Ethernet port on your PC using a crossover cable with RJ-45 connectors.

 This type of connection is recommended for identifying the **VS-88UT** with the factory configured default IP address.

After connecting the **VS-88UT** to the Ethernet port, configure your PC as follows:

1. Click **Start > Control Panel > Network and Sharing Center**.
2. Click **Change Adapter Settings**.
3. Highlight the network adapter you want to use to connect to the device and click **Change settings of this connection**.

The Local Area Connection Properties window for the selected network adapter appears as shown in [Figure 9](#).

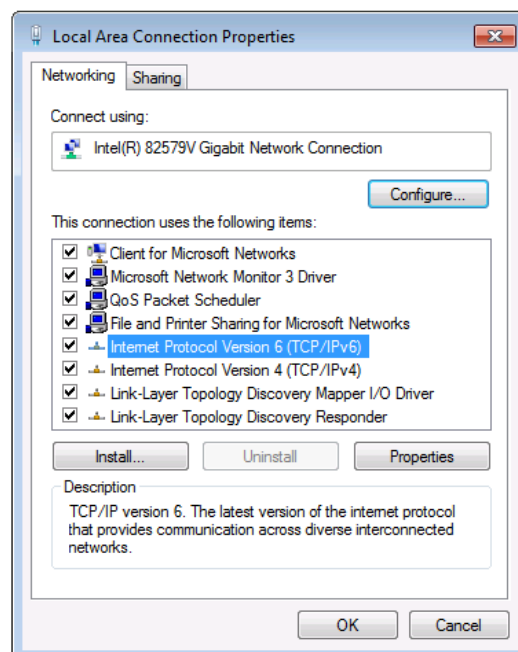

Figure 9: Local Area Connection Properties Window

4. Highlight either **Internet Protocol Version 6 (TCP/IPv6)** or **Internet Protocol Version 4 (TCP/IPv4)** depending on the requirements of your IT system.



5. Click **Properties**.

The Internet Protocol Properties window relevant to your IT system appears as shown in [Figure 10](#) or [Figure 11](#).

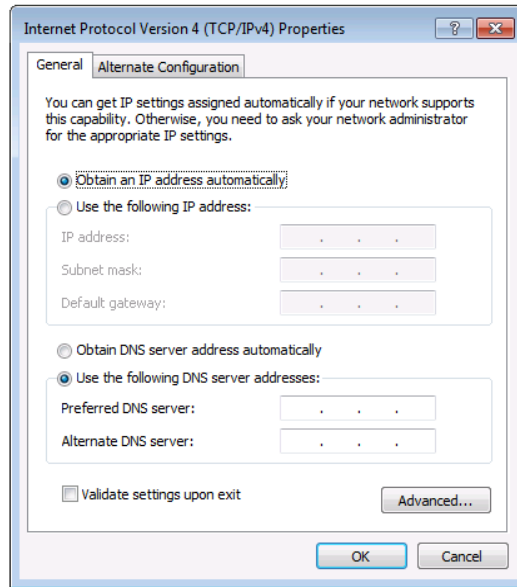

Figure 10: Internet Protocol Version 4 Properties Window

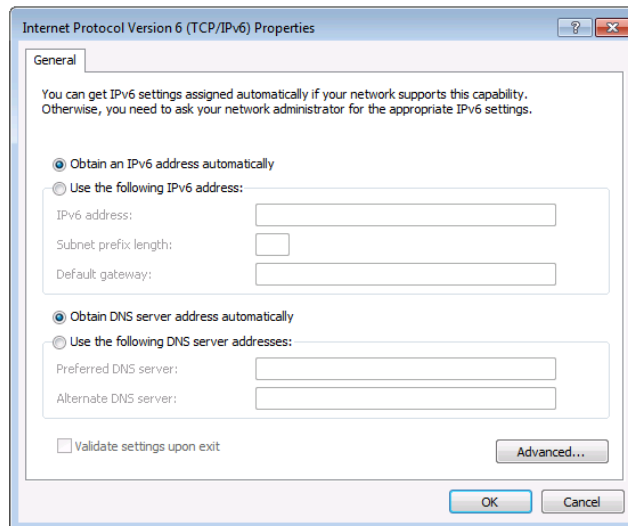

Figure 11: Internet Protocol Version 6 Properties Window

6. Select **Use the following IP Address** for static IP addressing and fill in the details as shown in [Figure 12](#).

For TCP/IPv4 you can use any IP address in the range 192.168.1.1 to 192.168.1.255 (excluding 192.168.1.39) that is provided by your IT department.

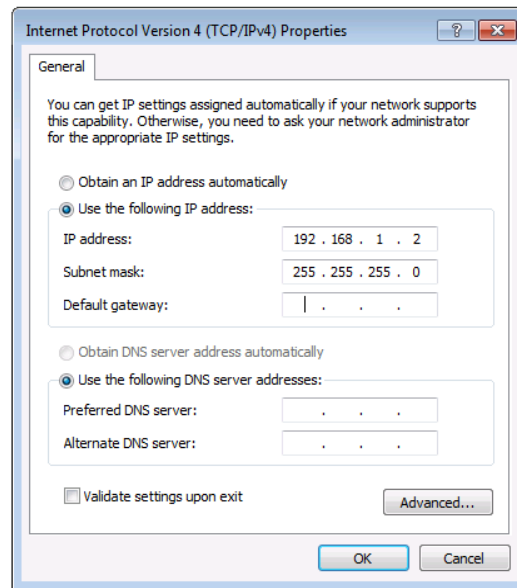

Figure 12: Internet Protocol Properties Window

7. Click **OK**.
8. Click **Close**.

## Connecting the Ethernet Port via a Network Hub or Switch

You can connect the Ethernet port of the VS-88UT to the Ethernet port on a network hub or using a straight-through cable with RJ-45 connectors.

## Control Configuration via the Ethernet Port

To control several units via Ethernet, connect the Master unit (Device 1) via the Ethernet port to the Ethernet port of your PC. Use your PC provide initial configuration of the settings (see [Connecting VS-88UT via the Ethernet Port](#) on page 13).

# Using the Web Pages

The Web pages let you control the **VS-88UT** via the Ethernet.

Before attempting to connect:

- Perform the procedures in [Connecting VS-88UT via the Ethernet Port](#) on page [13](#).
- Ensure that your browser is supported.

The supported operating systems and Web browsers are specified in the [Technical Specifications](#) on page [77](#).

The **VS-88UT** Web pages enable performing the following:

- [Global Mute Feature](#) on page [19](#).
- [Defining General Settings](#) on page [20](#).
- [Routing VS-88UT Ports](#) on page [23](#).
- [Controlling Devices via the Controller](#) on page [54](#).
- [Managing EDID](#) on page [66](#).
- [Changing the Device Settings](#) on page [70](#).
- [Setting Network Parameters](#) on page [74](#).
- [Viewing the About Page](#) on page [76](#).

**To browse the VS-88UT Web pages:**

1. Open your Internet browser.
2. Type the IP address of the device in the address bar of your browser. For example, the default IP address:



Figure 13: Using the Embedded Web pages – Default IP Address

The Authentication window appears: Admin

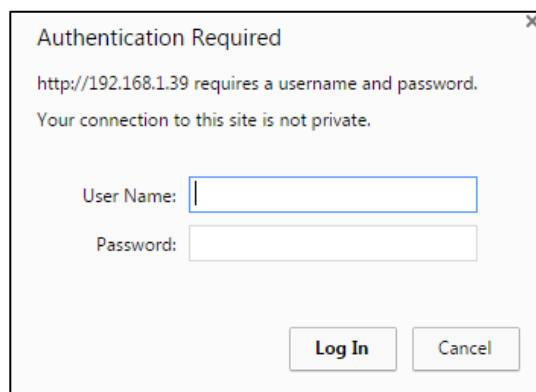

Figure 14: Using the Embedded Web Pages – Authentication Window

3. Enter the **User Name** and **Password** (Admin, Admin by-default) and click **OK**.  
The Routing Settings page appears.

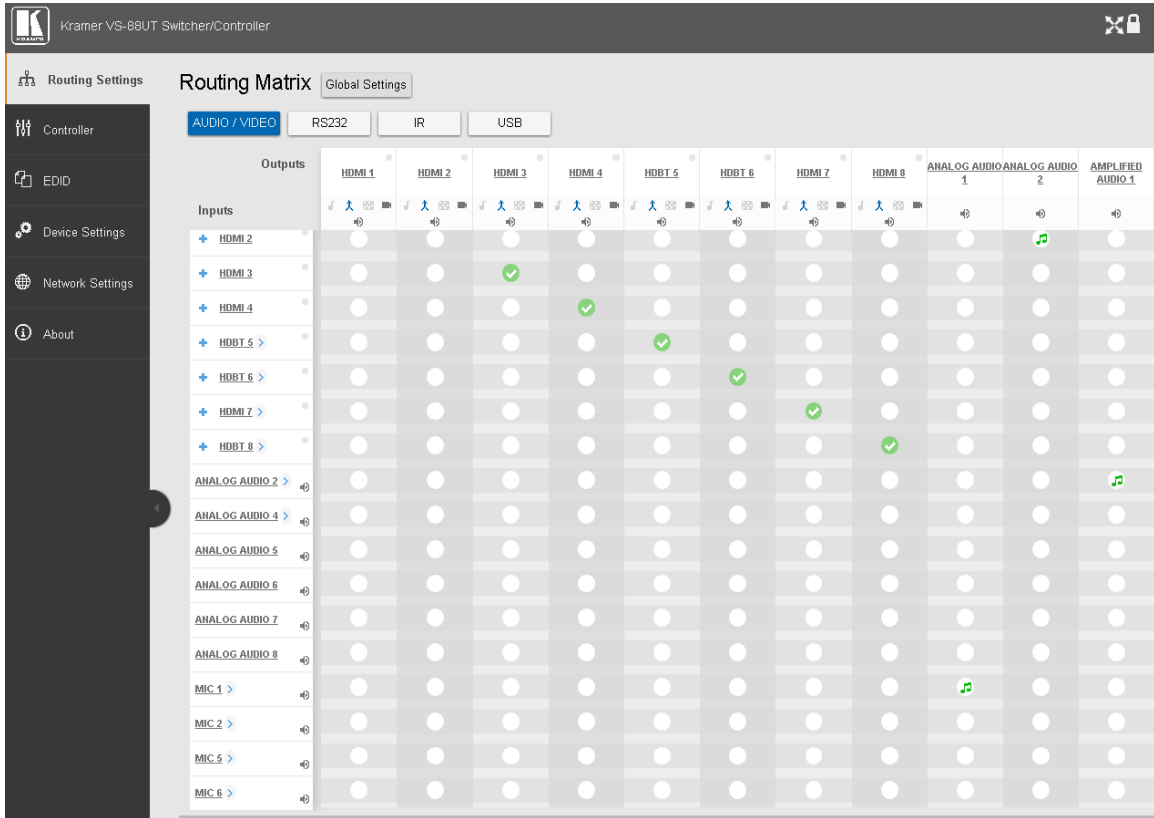

Figure 15: Routing Settings Page with Navigation List on Left

4. Click the desired Web page or click the arrow to hide the navigation list.

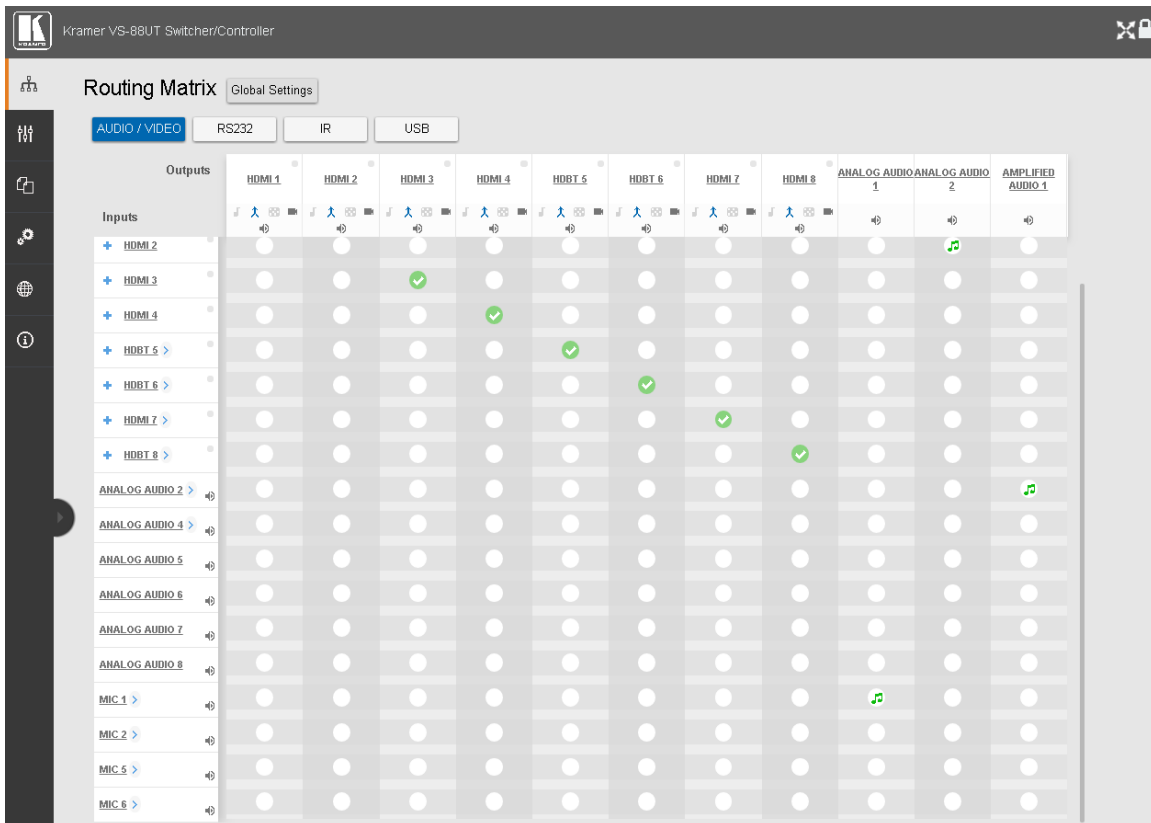

Figure 16: Routing Settings Page – Navigation List Hidden

# Global Mute Feature

The Global Mute system is a unique feature that mutes all the video and audio signals to enable easy integration of the audio system with public alarm systems used for alarms or other public messages.

When global mute is triggered via the “REMOTE MUTE” terminal block port (14), all HDMI/HDBT and analog outputs are globally muted and a warning note immediately appears on the web pages heading:

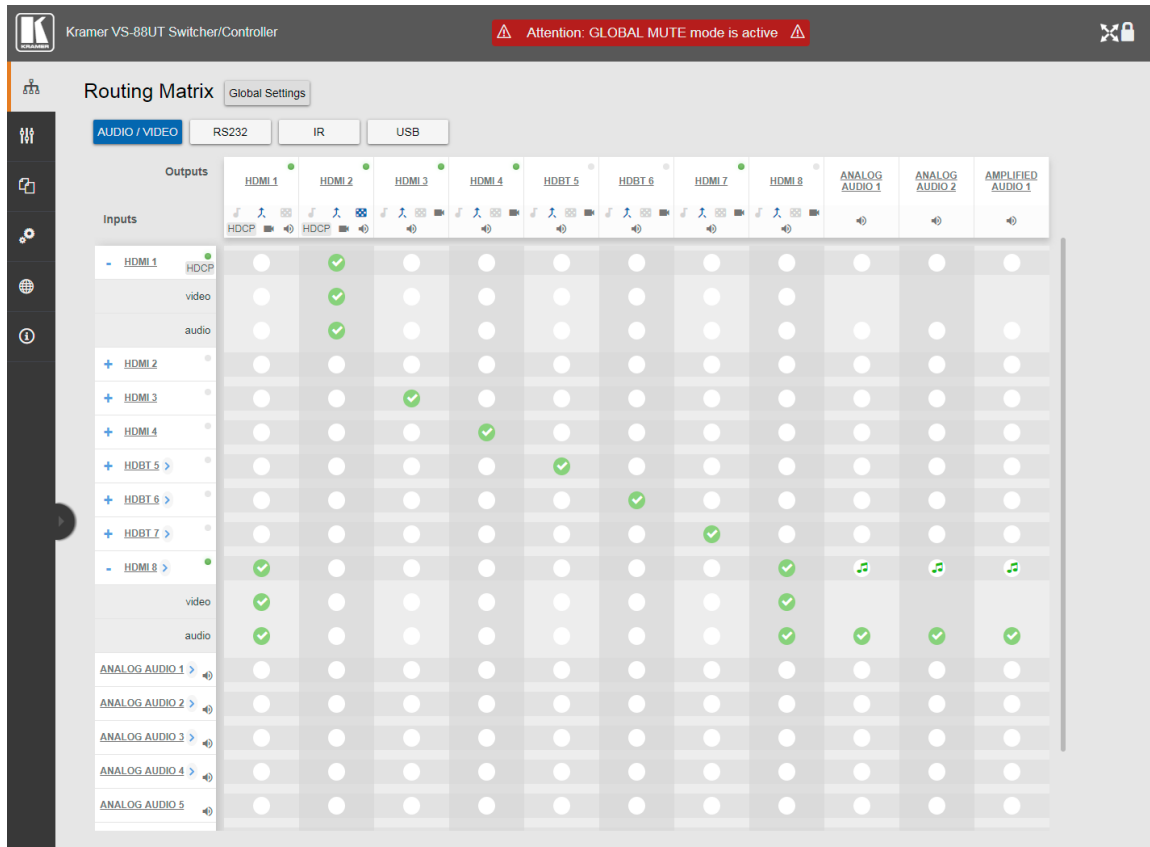

Figure 17: Global Mute Warning

This warning note notifies the administrator that the system is muted due to a REMOTE MUTE trigger. This trigger is indicated by the warning sign only and does not affect the display of mute icons in the Routing Settings page. Mute icons (🔇 or 🔇) on the outputs, that were set before the REMOTE MUTE was triggered, remain unchanged during the REMOTE MUTE mode and after it ceases.

When the REMOTE MUTE mode is over, the system returns to normal operation and the warning note disappears.

# Defining General Settings

Use the **Global Settings** page to set video timeouts, define ports and enable or disable power support via the HDBT ports.

To set the video timeouts:

1. In the Navigation pane, click **Routing Settings**. The Routing Matrix page appears (see [Figure 15](#)).
2. Click **Global Settings** (on the top left side).  
The Global Settings window appears:

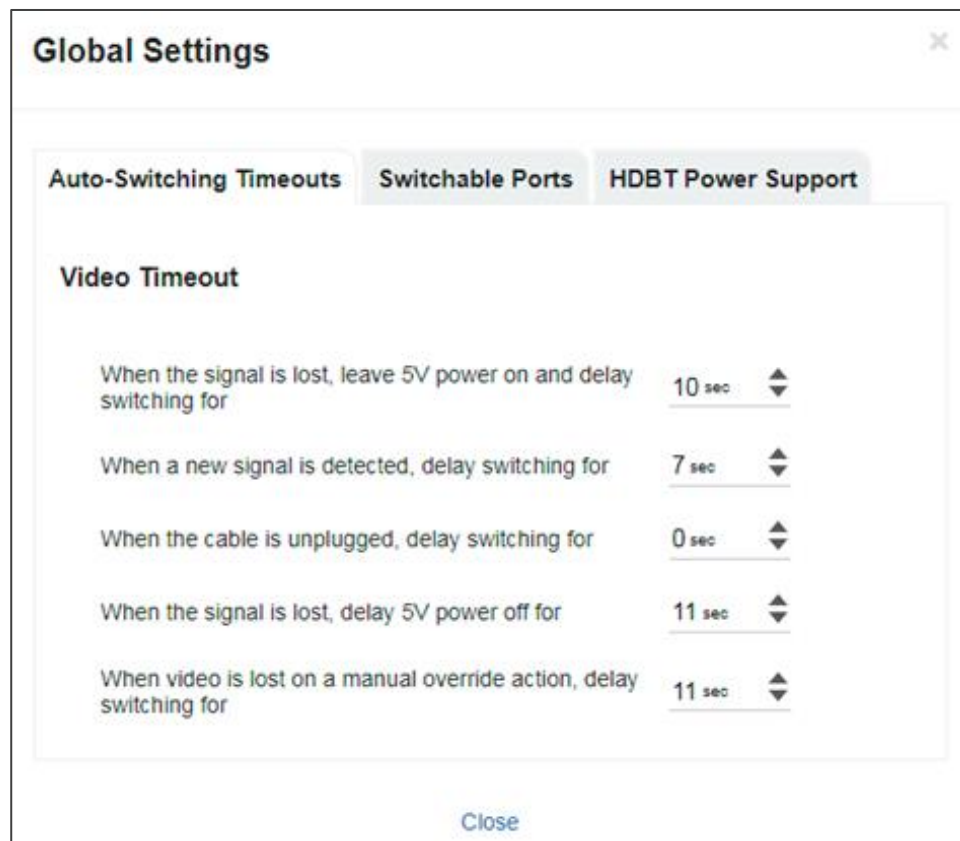

Figure 18: Global Settings Window – Auto-Switching Timeouts

3. Click the **Auto-Switching Timeouts** tab.
4. Set the timeout in seconds for delaying:
  - Switching upon signal loss when 5V power is left on.
  - Switching when a new signal is detected.
  - Switching in case a cable is unplugged.
  - 5V power off when the signal is lost.
  - Switching when video is lost during a manual override action.

5. Click **Close**.

For auto switching, the timeouts should be set as follows:

Timeout	Minimum Value	Default Value
Delay switching upon signal loss (signal off, 5V power on)	5 seconds	10 seconds
Delay switching upon cable unplug (signal off, power off)	0 seconds	0 seconds
Delay 5V power off upon signal loss (delay must be greater than “Delay switching upon signal loss”)	Should at least equal the larger of the above two values (signal loss timeout and cable unplug timeout)	900 seconds

**To set the switchable ports:**

1. In the Navigation pane, click **Routing Settings**. The Routing Matrix page appears.
2. Click **Global Settings** (on the top left side). The Global Settings window appears.
3. Click **Switchable Ports** tab. The Switchable Ports tab appears:

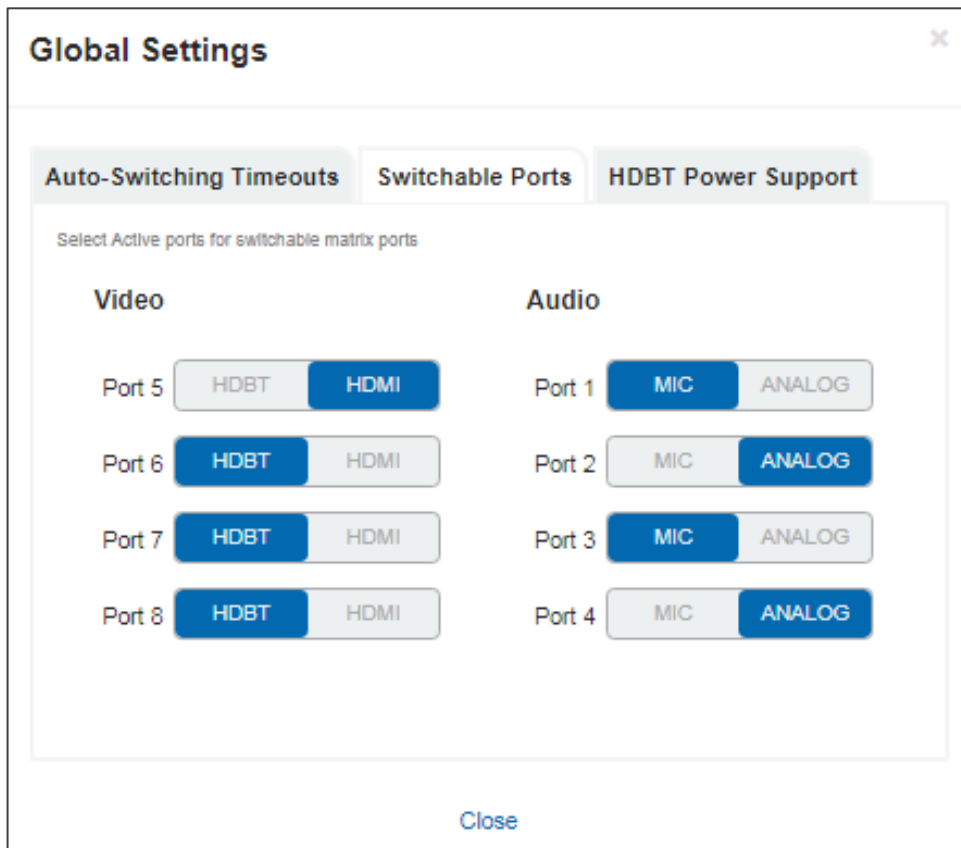

Figure 19: Global Settings Window – Switchable Ports Tab

4. For video input ports 5 to 8, select either the **HDBT** or **HDMI** input and for audio input ports 1 to 4, select either **ANALOG** or **MIC** input.  
The changes are immediately reflected the **Routing Settings** page.
5. Click **Close**.

**To set HDBT power support:**

1. In the Navigation pane, click **Routing Settings**. The Routing Matrix page appears.
2. Click **Global Settings** (on the top left side).  
The Global Settings window appears.
3. Click the **HDBT Power Support** tab.  
The HDBT Power Support tab appears:

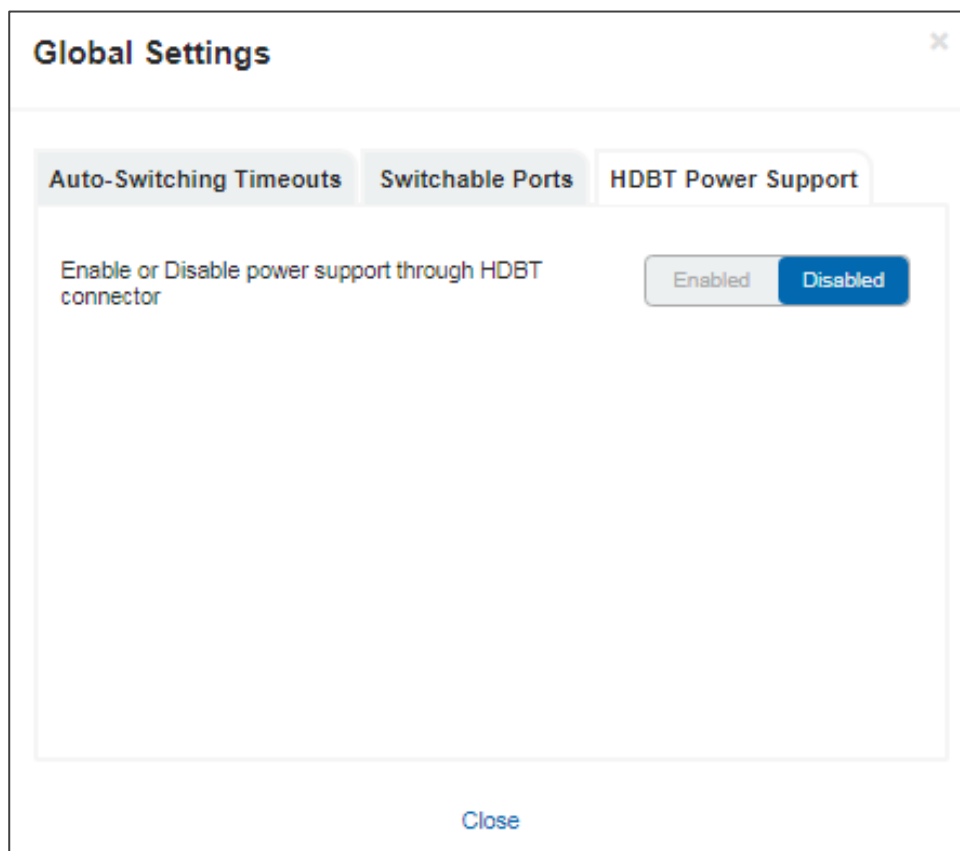

Figure 20: Global Settings Window – HDBT Power Support Tab

4. Enable or disable HDBT power support via the HDBT port.
5. Click **Close**.



# Routing VS-88UT Ports

This section describes how to basically route an A/V input to any of the outputs.



By default, input and output ports are set to audio-follow-video.

The Routing Matrix page displays the current routing status. For example, in [Figure 21](#) the HDMI 4 input is currently routed to the HDMI 1 output as indicated by the green routing button (✓).

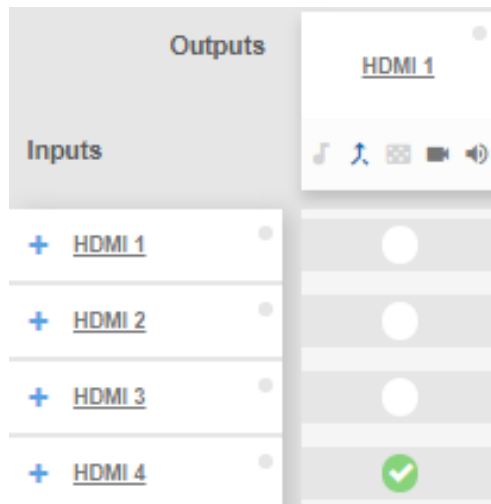

Figure 21: Routing Settings Page – Input to Output Example

To route an input to an output, click a white routing button within the matrix. For example, to route the HDMI 3 input to the HDMI 1 output, click the routing button connecting them in the matrix:

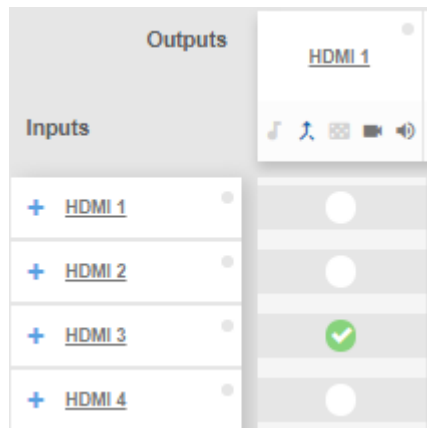

Figure 22: Routing Settings Page – Routing an Input to an Output

Hover over a port to view its switching status (HDMI 3 audio and video inputs are routed to HDMI 1 and HDMI 2 outputs):

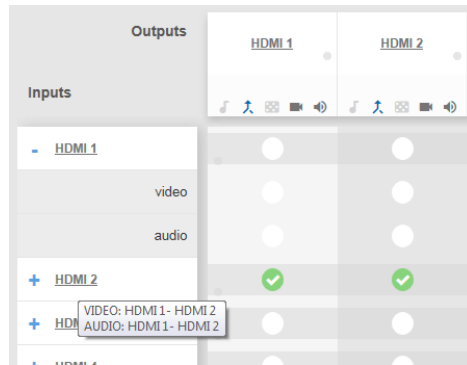

Figure 23: Routing Settings Page – Viewing the Switching Status

In the same way, you can route all the port types in the matrix if connected by a routing button.

To define each of the ports in the matrix and perform advanced routing operations, see [Defining Port Settings](#) on page 24.

---

## Defining Port Settings

This section describes how to route the ports (audio, video, RS-232, IR and USB) in the matrix and define the port settings.

The Routing Settings page enables the following:

- [Setting Input HDMI Port Parameters](#) on page 25.
- [Setting Input HDBT/HDMI Port Parameters](#) on page 33.
- [Setting Analog Audio Input Port Parameters](#) on page 39.
- [Setting the HDMI and HDBT Output Parameters](#) on page 44.
- [Setting Analog and Amplified Audio Output Parameters](#) on page 50.
- [Setting and Routing the RS-232 Ports](#) on page 51.
- [Setting and Routing IR Ports](#) on page 52.
- [Setting and Routing the USB Ports](#) on page 53.

# Setting Input HDMI Port Parameters

VS-88UT has four HDMI (1 to 4) inputs. The green indication indicates a valid signal on the input.



Figure 24: Port Settings – HDMI Input Ports

The following functions are available:

- [Viewing and Routing A/V Signals Separately](#) on page 25.
- [Routing A/V Signals in the Audio-Follow-Video and Breakaway Modes](#) on page 26.
- [Changing HDMI Input Port Settings](#) on page 29.

## Viewing and Routing A/V Signals Separately

To view the video and audio signals separately:

- Click + beside the input port name.
- The HDMI port line displays the status of each signal separately.  
The following example shows that the HDMI 1 input (both audio and video signals) is routed to output HDMI 1 and HDMI 2.

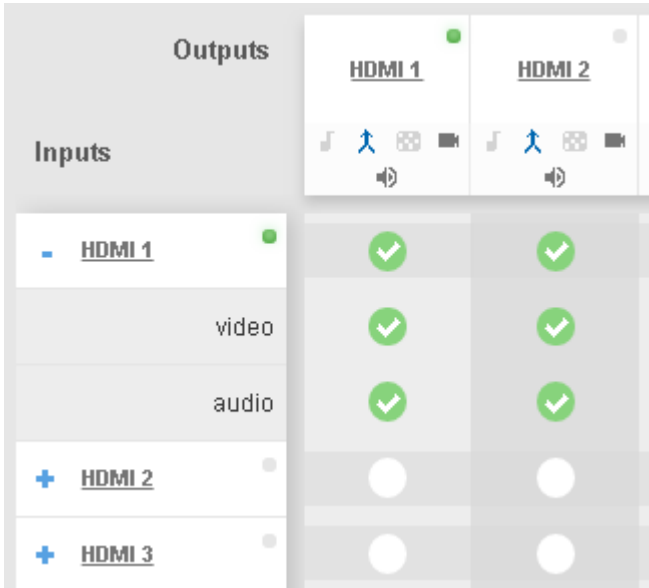

Figure 25: Routing Settings Page – HDMI Input Ports

- Click the HDMI 1 input audio button under output HDMI 3.  
The audio signal only is routed from HDMI 1 to HDMI 3

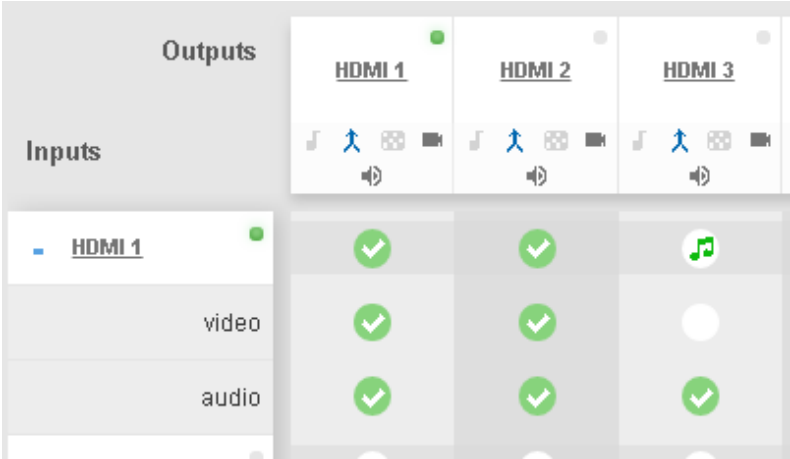

Figure 26: Routing Settings Page – Routing the audio signal only

- Click **-** to close the separate-signals view. The audio icon appears under the HDMI 3 output.

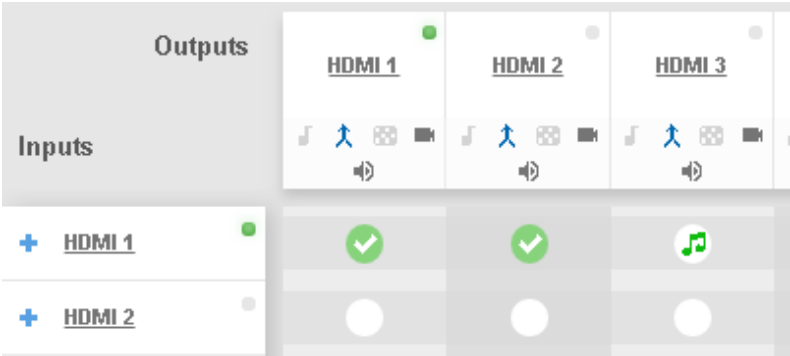

Figure 27: Routing Settings Page – Separate Audio Routing

**Routing A/V Signals in the Audio-Follow-Video and Breakaway Modes**

By default, all the outputs are set to the Audio-Follow-Video mode (AFV) mode . When routing an input to an output or only a video signal to an output, both audio and video signals appear on the output (see [Setting the HDMI and HDBT Output Parameters](#) on page 44).

Click the AFV icon to toggle between (AFV) and (Breakaway) modes

**To route an input to an output in the breakaway mode:**

- Click on an output (HDMI 3 in this example).  
The AFV icon is deselected and that output is now in the Breakaway mode.
- Click **+** beside the HDMI 1 input port name.

- Click Video Input 1 to output 3  
The audio signal no longer follows the video signal, therefore when routing a video signal, the audio signal does not follow.

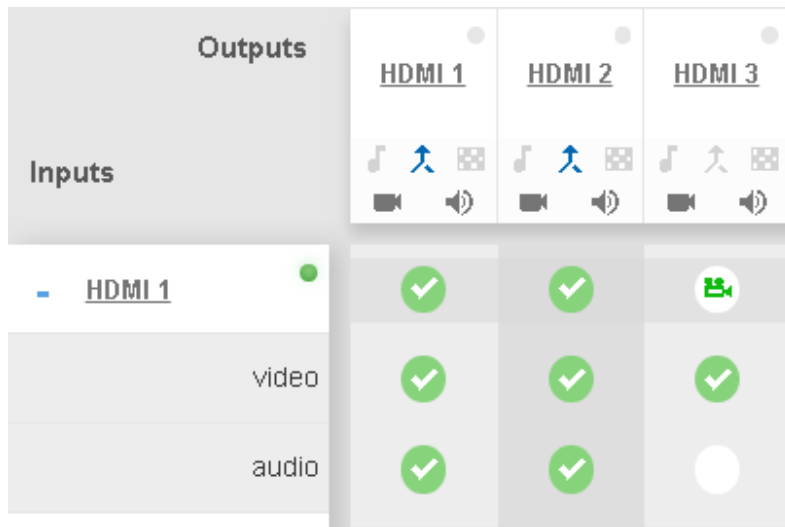



Figure 28: Routing Settings Page – Routing the Video Signal Only

- Click **-** to close the separate-signals view. The audio icon  appears under the HDMI 3 output.

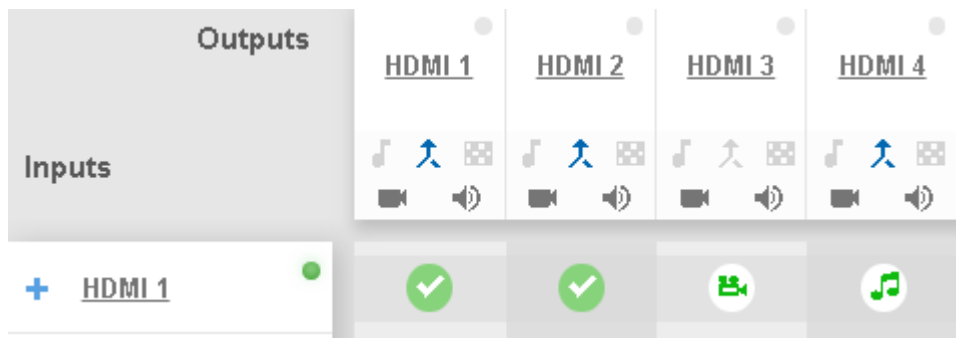



Figure 29: Routing Settings Page – Routing in the AFV Mode

Once you toggle  back to  (AFV) the audio signal is immediately routed to the HDMI 3 output.

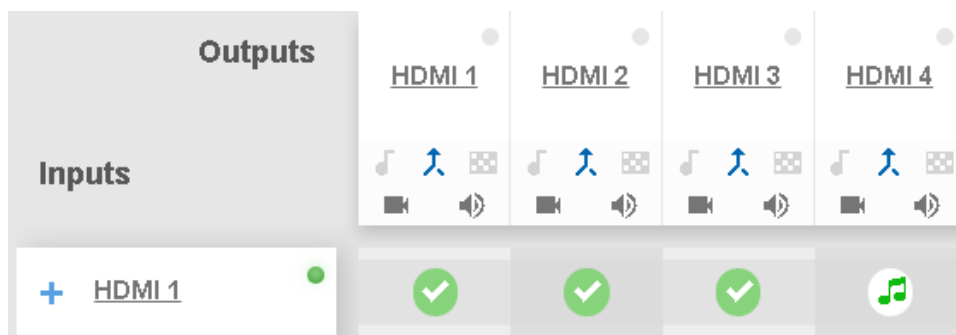

Figure 30: Routing Settings Page – Routing in the Breakaway Mode

In the breakaway mode you can also route the audio from one source and the video from another:

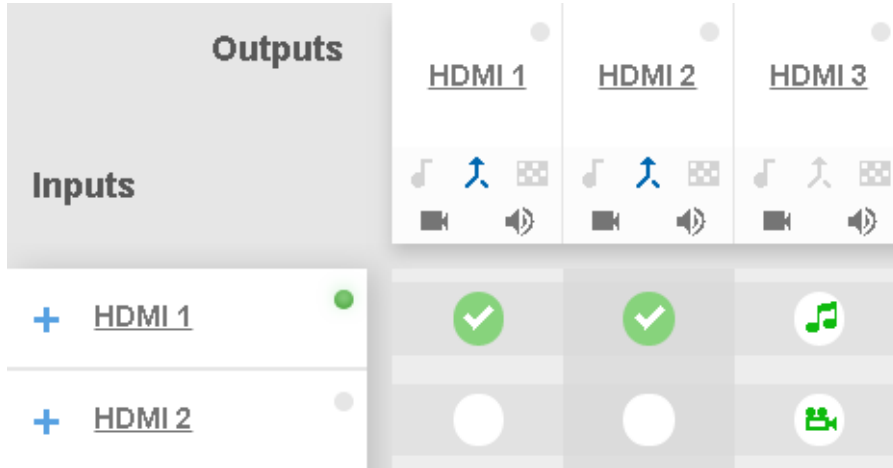

Figure 31: Routing Settings Page – Separate A/V Signal Sources in the Breakaway Mode

Once the AFV is back on, the input 2 audio signal follows the video signal.

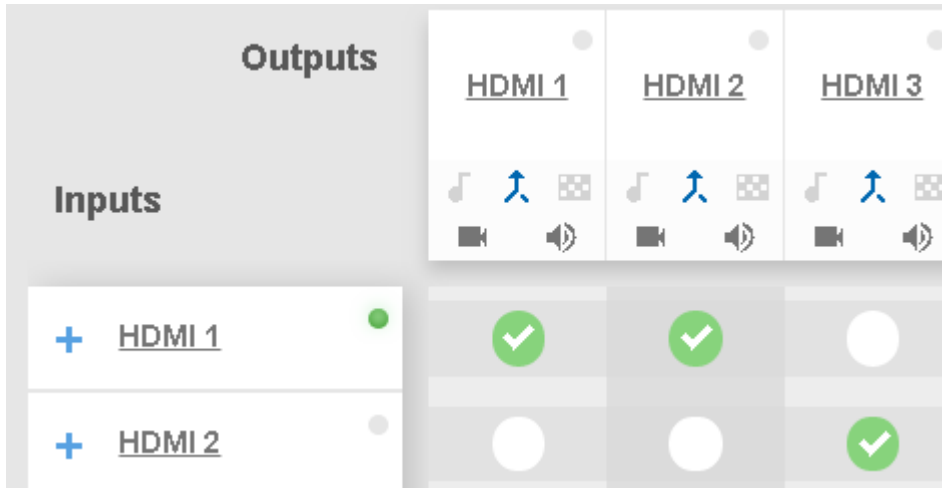

Figure 32: Routing Settings Page – A/V Signal Sources in the AFV Mode

## Changing HDMI Input Port Settings

To define the HDMI port:

1. Click **HDMI**.

The following window appears:

The screenshot shows a window titled "Input HDMI 2" with the following settings:

- Port Label:** HDMI 2
- HDCP Support:**
- Force RGB:**
- Force 2LPCM:**
- Routing Status:**
  - VIDEO:** OUT.HDMI.1, OUT.HDMI.2
  - AUDIO:** OUT.HDMI.1, OUT.HDMI.2
- Followers:** AUDIO: HDMI 2 (selected in a dropdown menu)

Buttons: Cancel, Save

Figure 33: Routing Settings Page – Input HDMI Settings

2. Perform the following actions, as required:

- Change the **Port Label** name.
- Check/uncheck **HDCP Support**.
- Check/uncheck **Force RGB**.
- Check/uncheck **Force 2LPCM**.
- View the **Routing Status**.
- Open the **AUDIO** drop-down box and select the audio signal to follow the HDMI video signal (see [Selecting the HDMI Input Follower](#) on page [30](#)).

3. Click **Save**.

## Selecting the HDMI Input Follower

When selecting a follower to the input signal, this follower is routed together with the input signal, to the selected output. When routing HDMI signals, you can define the AUDIO signal to follow the video signal.

 The follower signal is applied in the next routing step.

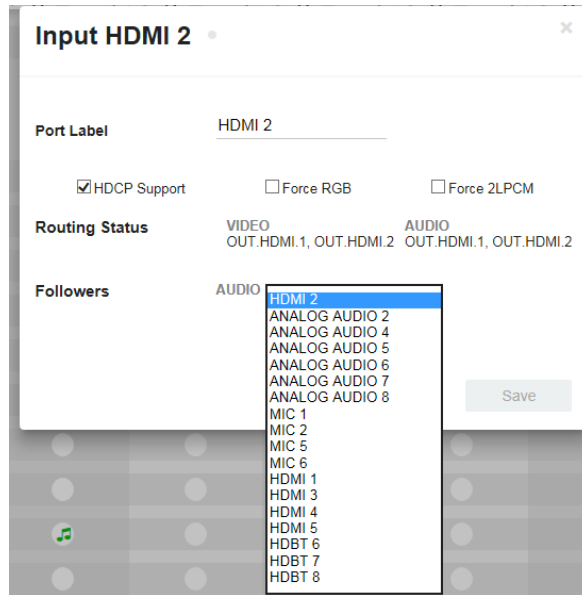

Figure 34: Routing Settings Page – HDMI 2 Input Audio Followers

For example, when routing input HDMI 1 to the HDMI 1 output, HDMI 1 audio is routed to the output.

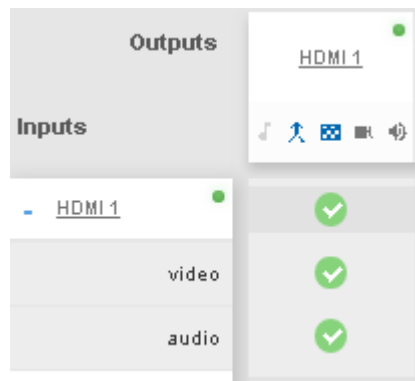

Figure 35: Routing Settings Page – Input HDMI 1 Routed to Output HDMI 1

Click the HDMI 1 output to see the settings page, and view the routing status:

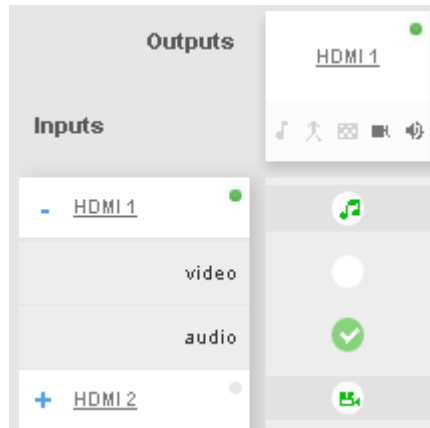

Figure 36: Routing Settings Page – HDMI 1 Output Routing Status

The routing status fits the settings on the HDMI 1 input.



When setting the HDMI 1 output to the breakaway mode, upon the next routing step (for example, HDMI 2 routed to HDMI 1, the audio source remains HDMI 1 and the video source is HDMI 2



<b>Routing Status</b>	VIDEO	AUDIO
	IN.HDMI.2	IN.HDMI.1

Figure 37: Routing Settings Page – HDMI 2 Input to HDMI 1 Routing Status

In the following example ANALOG AUDIO 2 is set as the audio follower for input HDMI 1:



Figure 38: Routing Settings Page – HDMI 1 Input, Analog Audio 2 Follows

In the AFV mode, whenever HDMI 1 is routed to an output the audio source will be ANALOG AUDIO 2:

Inputs	Outputs				
	HDMI 1	HDMI 2	HDMI 3	HDMI 4	HDBT 5
+ HDMI 1	✓	🔊	🔊	○	🔊
+ HDMI 2	○	○	○	○	○
+ HDMI 3	○	○	○	🔊	○
+ HDMI 4	○	○	○	○	○
+ HDBT 5	○	○	○	○	○
+ HDBT 6	○	○	○	🔊	○
+ HDMI 7	○	○	○	○	○
+ HDBT 8	○	○	○	○	○
ANALOG AUDIO 2	○	🔊	🔊	○	🔊

Figure 39: Routing Settings Page – Routing HDMI 1 Routed to Several Outputs

For the HDMI 1, HDMI 2, HDMI 3 and HDBT 5, ANALOG AUDIO 2 is the audio source.

Output Routing Status shows ANALOG AUDIO 2 as the source:

Routing Status	IR	VIDEO
	IN.HDBT.5, IN.HDBT.5	IN.HDMI.1
	AUDIO	RS232
	IN.ANALOG_AUDIO.2	BOTH.RS232.1
	USB	
	BOTH.USB_B.1	

Figure 40: Routing Settings Page – HDBT 5 Output Routing Status



For HDBT outputs, the Routing Status shows other signal followers (for example, HDBT 5 input IR follows the video signal).

In the breakaway mode, when routing the HDMI 1 input to HDMI 2 output, ANALOG AUDIO 2 is still the audio source:

Outputs	HDMI 1	HDMI 2
<b>Inputs</b>	🎵 🔊 📺 📡 🔊	🎵 🔊 📺 📡 🔊
+ HDMI 1	📺	🔊
+ HDMI 2	🎵	🔊
+ HDMI 3	🔊	📺
+ HDMI 4	🔊	🔊
+ HDBT 5 >	🔊	🔊
+ HDBT 6 >	🔊	🔊
+ HDMI 7 >	🔊	🔊
+ HDBT 8 >	🔊	🔊
ANALOG AUDIO 2 > 🔊	🔊	🎵

Figure 41: Routing Settings Page – HDBT 6 Output Routing Status

Click  to return to the AFV mode. When routing the HDMI 1 input to HDMI 2 output, the audio source is ANALOG AUDIO 2 once again.

## Setting Input HDBT/HDMI Port Parameters

VS-88UT has four ports that can be set as HDBT or HDMI (5 to 8) inputs. The green indication indicates a valid signal on the input.

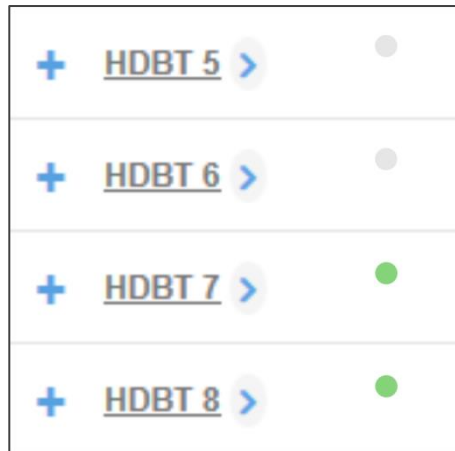

Figure 42: Port Settings – HDBT Input Ports

The following functions are available:

- [Viewing and Routing HDMI/HDBT A/V Signals Separately](#) on page 34
- [Setting the Port to HDBT or HDMI](#) on page 33.
- [Changing HDBT/HDMI Port Settings](#) on page 34.

### Setting the Port to HDBT or HDMI

To set the port to HDBT or HDMI:

1. Click > next to the port name.
2. Select the desired port:

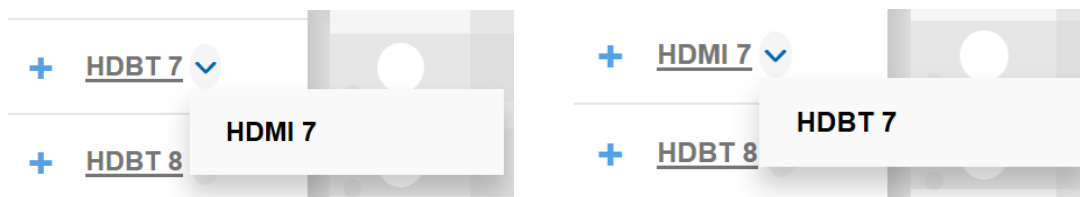

Figure 43: Port Settings – Selecting HDBT or HDMI Input Ports

## Viewing and Routing HDMI/HDBT A/V Signals Separately

To view the video and audio signals separately:

- Click **+** beside the port name.
- The HDMI/HDBT port line displays the status of each signal separately. The following example shows that the HDBT 8 input (both audio and video signals) is routed to HDMI 1 and HDMI 3.

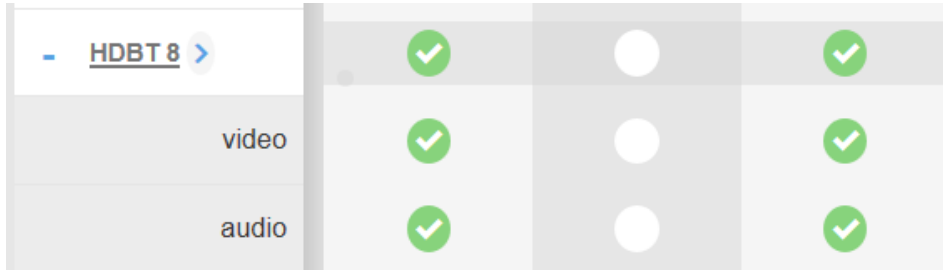

Figure 44: Port Settings – HDBT Input Ports

- Click **-** to close the separate-signals view.

## Changing HDBT/HDMI Port Settings

To define the HDBT/HDMI port:

1. Click **HDBT** (HDMI is described in [Changing HDMI Input Port Settings](#) on page 29). The following window appears:

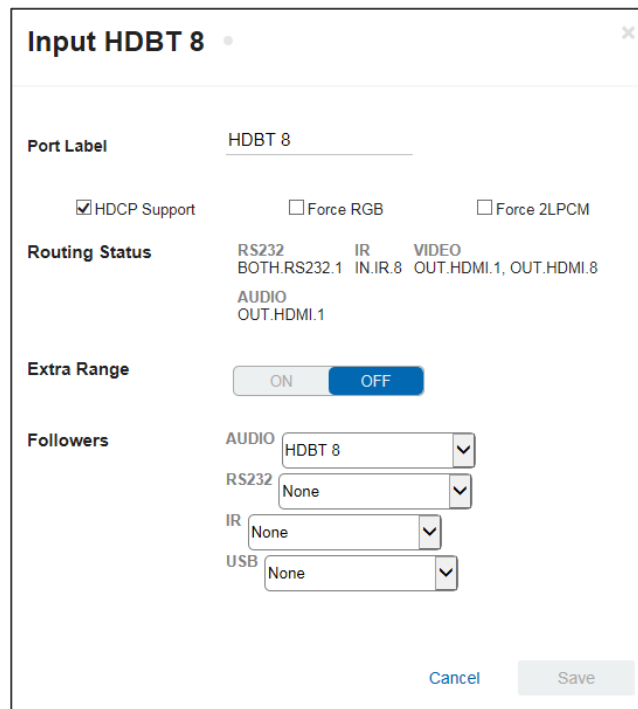



Figure 45: Routing Settings Page – Input HDBT Settings

Each setting retains the switching state (followers are specific for the HDMI and HDBT port).

2. Perform the following actions, as required:
  - Change the **Port Label** name.
  - Check/uncheck **HDCP Support**.
  - Check/uncheck **Force RGB**.
  - Check/uncheck **Force 2LPCM**.
  - View the **Routing Status**.
  - Set **Extra Range** to ON or OFF.
  - Select **Followers** drop-down boxes for AUDIO, RS-232, IR, and USB signals.  
The selected port signals will now follow the video signal (see [Selecting the HDBT Input Followers](#) on page 35).
3. Click **Save**.

### Selecting the HDBT Input Followers

When selecting a follower to the input signal, this follower is routed together with the input signal, to the selected output. When routing HDBT signals, you can define AUDIO, RS-232, IR, and USB signals to follow the video signal.

 The follower signals are applied in the next routing step.

<b>Followers</b>	AUDIO	RS232
	HDBT 5	RS232 1
	IR	USB
	HDBT 5	USB Type- B1

Figure 46: Routing Settings Page – Input HDBT 5 Followers Settings

For example, when routing input HDBT 5 to the HDBT 6 output, HDBT 5 audio is routed to the output.

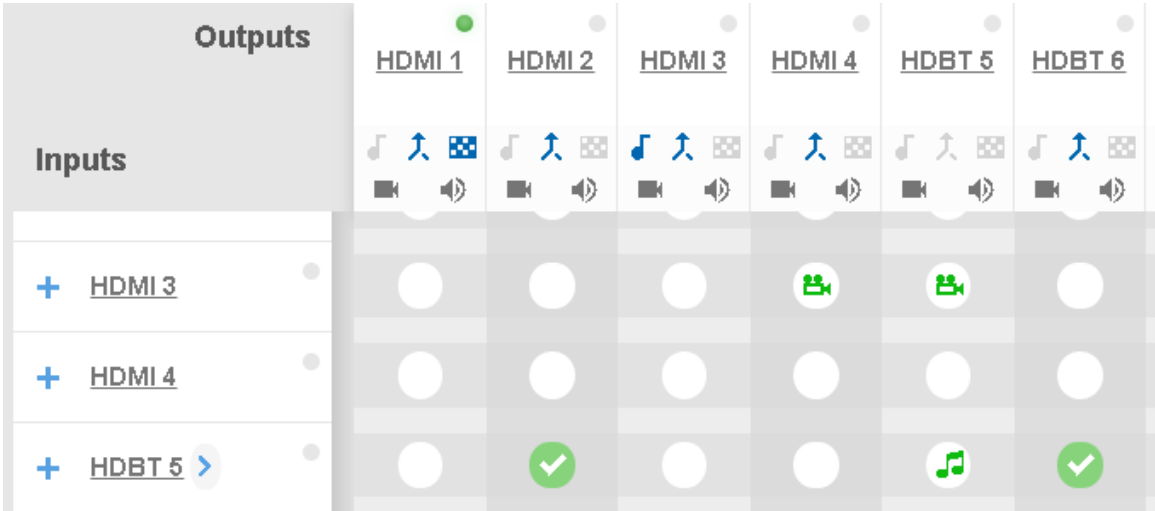

The routing matrix shows the following configuration:

Outputs	HDMI 1	HDMI 2	HDMI 3	HDMI 4	HDBT 5	HDBT 6
Inputs	[Icons for Audio, Video, and other signals]					
+ HDMI 3	[Circle]	[Circle]	[Circle]	[Circle]	[Circle]	[Circle]
+ HDMI 4	[Circle]	[Circle]	[Circle]	[Circle]	[Circle]	[Circle]
+ HDBT 5	[Circle]	[Checkmark]	[Circle]	[Circle]	[Music Note]	[Checkmark]

Figure 47: Routing Settings Page – Input HDBT 5 Routed to Output HDBT 6

Click the HDBT 6 output to see the settings page, and view the routing status:

<b>Routing Status</b>	<b>IR</b>	<b>VIDEO</b>	<b>AUDIO</b>
	IN.HDBT.5, IN.HDBT.5		IN.HDBT.5
	<b>RS232</b>	<b>USB</b>	
	BOTH.RS232.1		BOTH.USB_B.1

Figure 48: Routing Settings Page – HDBT 6 Output Routing Status

The routing status fits the settings on the HDBT 5 input.



When routing in the AFV mode, all the followers, follow the video routing.

When setting the HDBT 6 output to the breakaway mode, upon the next routing step (for example, HDBT 6 routed to HDBT 6, the routing status will remain the same (except for the video signal):

<b>Routing Status</b>	<b>IR</b>	<b>VIDEO</b>	<b>AUDIO</b>
	IN.HDBT.5, IN.HDBT.5		IN.HDBT.6
	<b>RS232</b>	<b>USB</b>	
	BOTH.RS232.1		BOTH.USB_B.1

Figure 49: Routing Settings Page – HDBT 6 Input to HDBT 6 Output Routing Status

In the following example MIC 1 is set as the audio follower for input HDBT 5:

<b>Followers</b>	<b>AUDIO</b>	<b>RS232</b>
	MIC 1 ▼	RS232 1 ▼
	<b>IR</b>	<b>USB</b>
	HDBT 5 ▼	USB Type- B1 ▼

Figure 50: Routing Settings Page – HDBT 5 Input, MIC 1 Audio follows

In the AFV mode, whenever HDBT 5 is routed to an output (for example, HDBT 5) the audio source will be MIC 1:

Outputs	HDMI 1	HDMI 2	HDMI 3	HDMI 4	HDBT 5
<b>Inputs</b>					
+ HDBT 5 >	<input type="radio"/>	<input checked="" type="radio"/>	<input checked="" type="radio"/>	<input type="radio"/>	<input checked="" type="radio"/>
+ HDBT 6 >	<input type="radio"/>	<input type="radio"/>	<input type="radio"/>	<input checked="" type="radio"/>	<input type="radio"/>
+ HDMI 7 >	<input type="radio"/>	<input type="radio"/>	<input type="radio"/>	<input type="radio"/>	<input type="radio"/>
+ HDBT 8 >	<input type="radio"/>	<input type="radio"/>	<input type="radio"/>	<input type="radio"/>	<input type="radio"/>
ANALOG AUDIO 2 >	<input type="radio"/>	<input type="radio"/>	<input type="radio"/>	<input type="radio"/>	<input type="radio"/>
ANALOG AUDIO 4 >	<input type="radio"/>	<input type="radio"/>	<input type="radio"/>	<input type="radio"/>	<input type="radio"/>
ANALOG AUDIO 5	<input type="radio"/>	<input type="radio"/>	<input type="radio"/>	<input type="radio"/>	<input type="radio"/>
ANALOG AUDIO 6	<input type="radio"/>	<input type="radio"/>	<input type="radio"/>	<input type="radio"/>	<input type="radio"/>
ANALOG AUDIO 7	<input type="radio"/>	<input type="radio"/>	<input type="radio"/>	<input type="radio"/>	<input type="radio"/>
ANALOG AUDIO 8	<input type="radio"/>	<input type="radio"/>	<input type="radio"/>	<input type="radio"/>	<input type="radio"/>
MIC 1 >	<input type="radio"/>	<input type="radio"/>	<input type="radio"/>	<input type="radio"/>	<input checked="" type="radio"/>

Figure 51: Routing Settings Page –Routing HDBT 5 Input to HDBT 6 Output

The HDBT 5 output routing status shows MIC 1 as the source:

Routing Status	IR	VIDEO	AUDIO
	IN.HDBT.5, IN.HDBT.5	IN.HDBT.5	IN.MIC.1
	RS232	USB	
	BOTH.RS232.1	BOTH.USB_B.1	

Figure 52: Routing Settings Page – HDBT 6 Output Routing Status

In the breakaway mode, when routing the HDBT 6 input to HDBT 5 output MIC 1 is still the audio source:

Outputs	Inputs				
	HDMI 1	HDMI 2	HDMI 3	HDMI 4	HDBT 5
+ HDBT 5 >	<input type="radio"/>	<input checked="" type="radio"/>	<input checked="" type="radio"/>	<input type="radio"/>	<input type="radio"/>
+ HDBT 6 >	<input type="radio"/>	<input type="radio"/>	<input type="radio"/>	<input checked="" type="radio"/>	<input checked="" type="radio"/>
+ HDMI 7 >	<input type="radio"/>	<input type="radio"/>	<input type="radio"/>	<input type="radio"/>	<input type="radio"/>
+ HDBT 8 >	<input type="radio"/>	<input type="radio"/>	<input type="radio"/>	<input type="radio"/>	<input type="radio"/>
ANALOG AUDIO 2 >	<input type="radio"/>	<input type="radio"/>	<input type="radio"/>	<input type="radio"/>	<input type="radio"/>
ANALOG AUDIO 4 >	<input type="radio"/>	<input type="radio"/>	<input type="radio"/>	<input type="radio"/>	<input type="radio"/>
ANALOG AUDIO 5	<input type="radio"/>	<input type="radio"/>	<input type="radio"/>	<input type="radio"/>	<input type="radio"/>
ANALOG AUDIO 6	<input type="radio"/>	<input type="radio"/>	<input type="radio"/>	<input type="radio"/>	<input type="radio"/>
ANALOG AUDIO 7	<input type="radio"/>	<input type="radio"/>	<input type="radio"/>	<input type="radio"/>	<input type="radio"/>
ANALOG AUDIO 8	<input type="radio"/>	<input type="radio"/>	<input type="radio"/>	<input type="radio"/>	<input type="radio"/>
MIC 1 >	<input type="radio"/>	<input type="radio"/>	<input type="radio"/>	<input type="radio"/>	<input checked="" type="radio"/>

Figure 53: Routing Settings Page – HDBT 6 Output Routing Status

Then, when setting HDBT 7 input as audio source, MIC 1 is no longer the audio source:

Outputs	Inputs				
	HDMI 1	HDMI 2	HDMI 3	HDMI 4	HDBT 5
+ HDBT 5 >	<input type="radio"/>	<input checked="" type="radio"/>	<input checked="" type="radio"/>	<input type="radio"/>	<input type="radio"/>
+ HDBT 6 >	<input type="radio"/>	<input type="radio"/>	<input type="radio"/>	<input checked="" type="radio"/>	<input checked="" type="radio"/>
- HDMI 7 >	<input type="radio"/>	<input type="radio"/>	<input type="radio"/>	<input type="radio"/>	<input checked="" type="radio"/>
video	<input type="radio"/>	<input type="radio"/>	<input type="radio"/>	<input type="radio"/>	<input type="radio"/>
audio	<input type="radio"/>	<input type="radio"/>	<input type="radio"/>	<input type="radio"/>	<input checked="" type="radio"/>

Figure 54: Routing Settings Page – HDBT 5 Output in the Breakaway Mode

Click  to return to the AFV mode. When routing the HDBT 5 input to HDBT 5 output, the audio source is MIC 1 once again.



## Setting Analog Audio Input Port Parameters

VS-88UT has eight stereo analog audio inputs: 1 to 4 are balanced inputs and 5 to 8 are unbalanced inputs.

Each of the balanced analog inputs (1 to 4) can also function as microphone inputs (MIC 1 to MIC 8); inputs 5 to 8 function as unbalanced analog inputs.

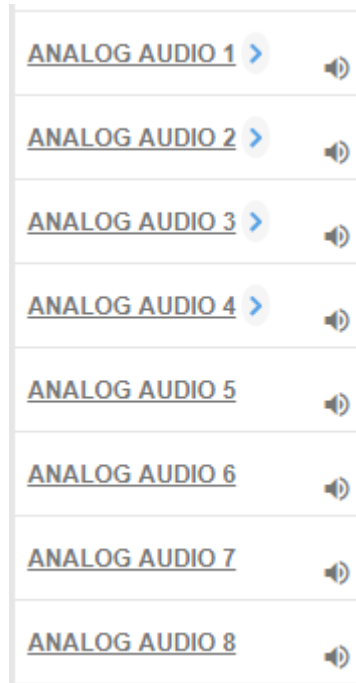



Figure 55: Port Settings – Analog Audio Input Ports

The following functions are available:

- [Setting the Input Volume](#) on page 40.
- [Changing the Analog Audio Port Settings](#) on page 41.
- [Setting the Port to Analog Input or Two Microphones](#) on page 41.
- [Changing the Microphone Port Settings](#) on page 43.

### Setting the Input Volume

To set the input volume:

- 1. Click  .  
The volume slider window appears.
- 2. Set the volume (set to 0dB by default).

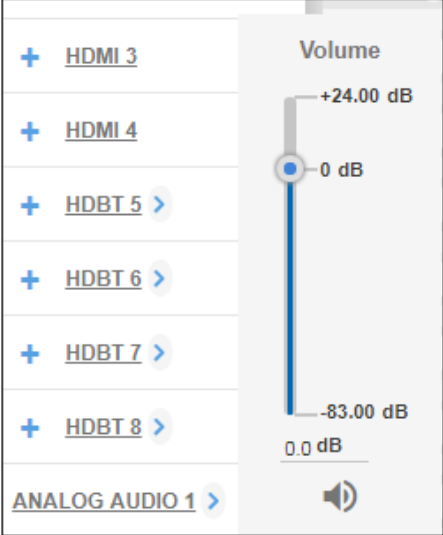

Figure 56: Port Settings –Setting Analog Audio Level

- 3. If required, click  to mute the input.

## Changing the Analog Audio Port Settings

### To set the ANALOG AUDIO Port

1. Click **ANALOG AUDIO**.  
The following window appears:

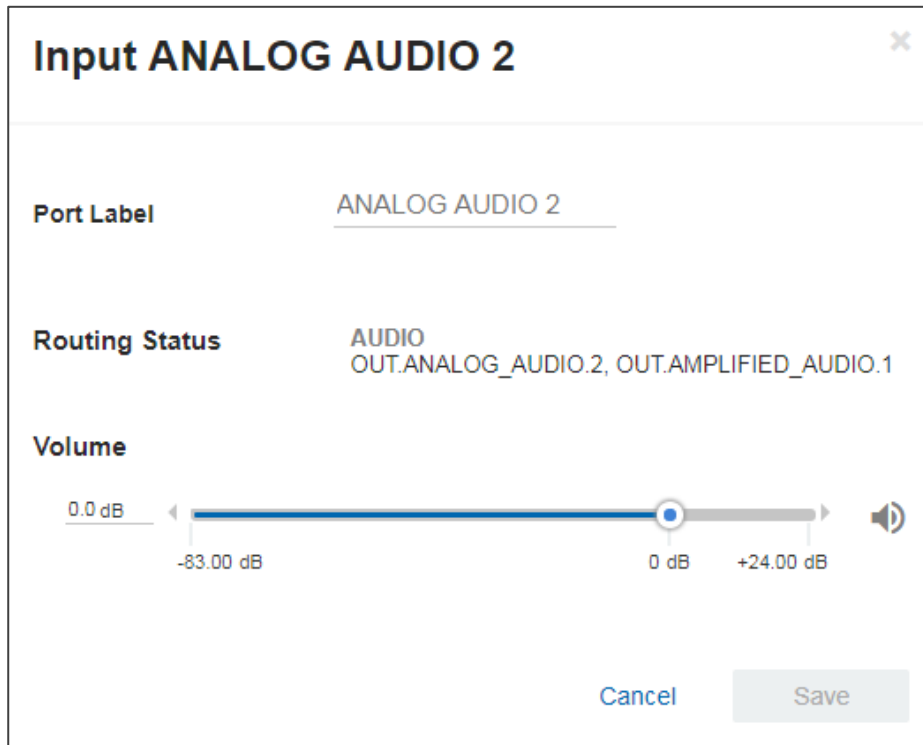



Figure 57: Routing Settings Page – Input ANALOG AUDIO Settings

2. Perform the following actions, as required:
  - Change the **Port Label** name.
  - View the **Routing Status**.
  - Set the **Volume**.
3. Click **Save**.

### Setting the Port to Analog Input or Two Microphones

To set a port to function as an analog input or as two microphone inputs:

1. Click  next to the port name.
2. Set ANALOG AUDIO 1 (for example) to MIC 1 MIC 2 desired port.

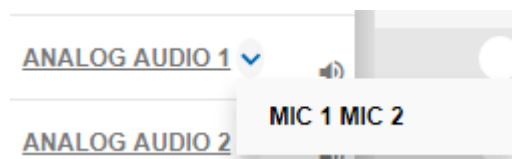

Figure 58: Port Settings – Selecting Analog Audio or Mic Input Ports

The ANALOG AUDIO 1 is replaced by MIC 1 and MIC 2 ports:

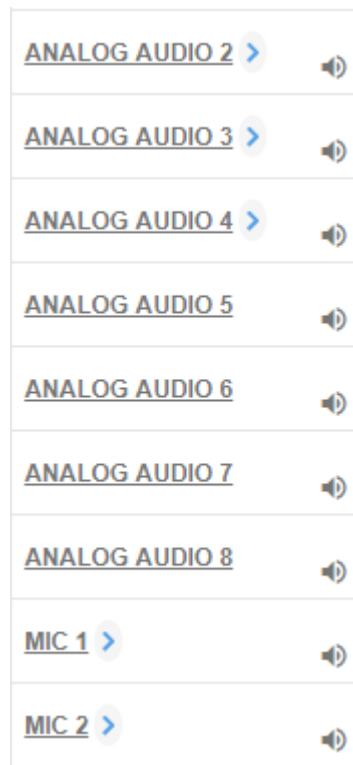



Figure 59: Port Settings – Setting MIC Ports

In the same way ANALOG AUDIO 2 (MIC 3 and MIC 4), ANALOG AUDIO 3 (MIC 5 and MIC 6) and ANALOG AUDIO 4 (MIC 7 and MIC 8) can interchange.

**To set a MIC port to function as an analog input:**

1. Click  next to one of the MIC ports.
2. Set MIC 1 (for example) to ANALOG AUDIO 1.

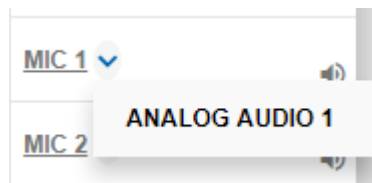

Figure 60: Port Settings – Selecting MIC to ANALOG AUDIO

ANALOG AUDIO 1 is restored:

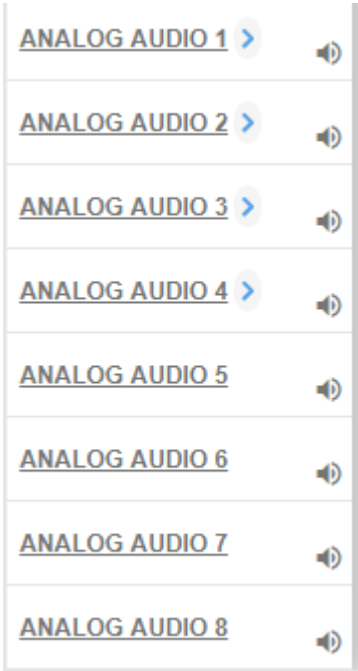

Figure 61: Port Settings – Setting MIC Ports

### Changing the Microphone Port Settings

To change the MIC Port settings:

- 1. Click **MIC**.

The following window appears:

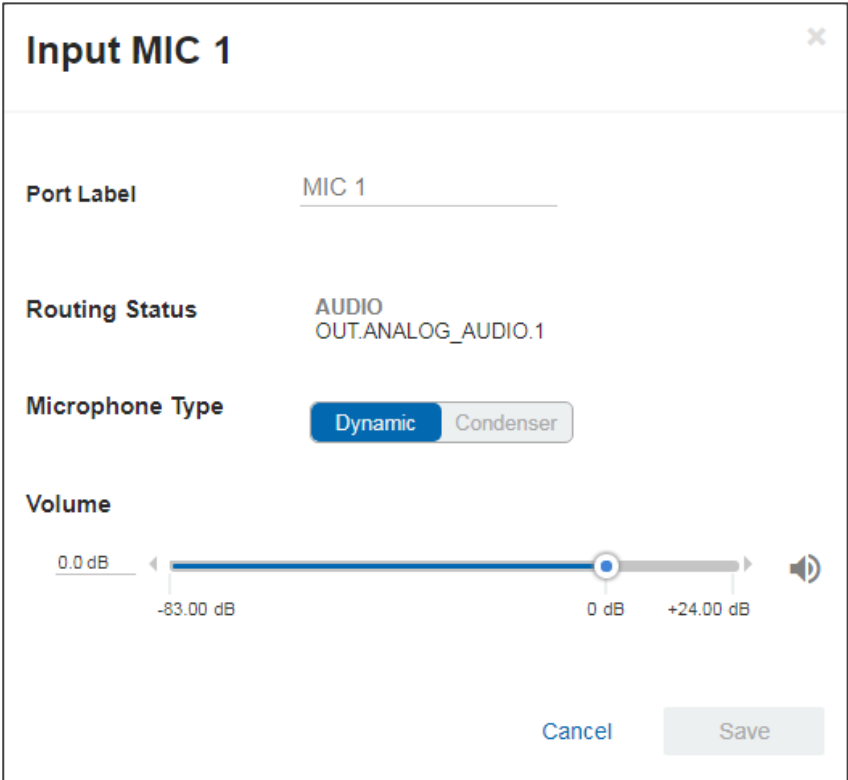

Figure 62: Routing Settings Page – Input MIC Settings

Each setting (ANALOG or MIC) retains the switching state (followers are specific for the defined port).

2. Perform the following actions, as required:
  - Change the **Port Label** name.
  - View the **Routing Status**.
  - Set the **Microphone Type** to Dynamic or Condenser.
  - Set Microphone **Volume**.
3. Click **Save**.

## Setting the HDMI and HDBT Output Parameters

VS-88UT has six HDMI (1 to 4 and 7 to 8) outputs and two HDBT outputs (5 to 6). The green indication indicates a valid signal on the output.

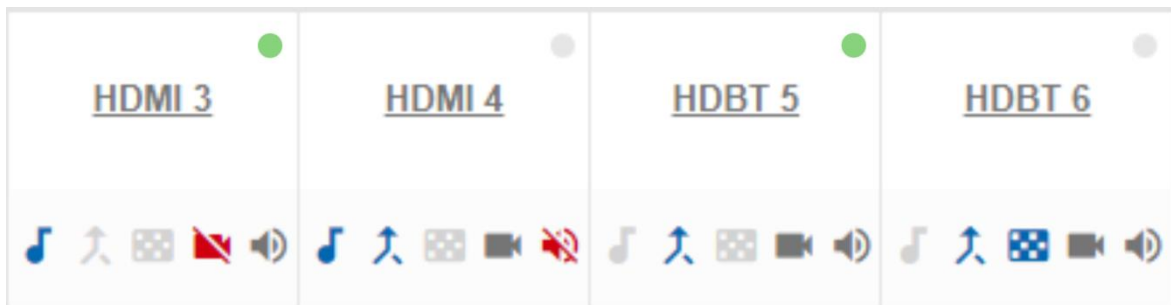

Figure 63: Port Settings – HDMI and HDBT Output Ports

The HDMI icons enable performing the following actions:

- Enabling audio only mode (🎵): only audio is routed through the output (a black pattern screen is displayed and 5V cut off is disabled).
- Enabling/Disabling audio follow video (👤): both audio and video are routed through the output.
- Select a pattern to display on the output (🎮 or 🎯 if a pattern is selected).



If a pattern is selected on an output and an input is routed to that output, the pattern is disabled and the routed video signal appears on the output.

- Turn HDMI on or off (📺 or 📺).
- Mute or unmute the audio signal (🔊 or 🔊).

The following functions are available:

- [Changing the HDMI Output Port Settings](#) on page 45.
- [Changing the HDBT Output Port Settings](#) on page 47.

### Changing the HDMI Output Port Settings

To set the HDMI output port:

- 1. Click **HDMI**.  
The following window appears:

**Output HDMI 3** [Close]

**Audio only**  ON  OFF

**Port Label**

AFV

**Routing Status** VIDEO IN.HDMI.3 AUDIO IN.HDMI.3

**Video Pattern**

**Auto Switching**

Priority	Input	
1	HDMI 1	✗
2	HDMI 2	✗
3	HDMI 3	✗
4	HDMI 4	✗

5	HDBT 5	✗
6	HDBT 6	✗
7	HDBT 7	✗
8	HDBT 8	✗

Figure 64: Routing Settings Page – Output HDMI Settings

2. Perform the following actions, as required:
  - Set **Audio only** to ON or OFF.
  - Change the **Port Label** name.
  - Check/uncheck **AFV**.
  - View the **Routing Status**.
  - Select a **Video Pattern**.
  - Open the **Auto Switching** drop-down box and select Manual, Priority or Last Connected switching, see [Auto Switching Feature](#) on page [48](#).
3. Click **Save**.



### Changing the HDBT Output Port Settings

To set the HDBT output port:

- 1. Click **HDBT**.  
The following window appears:

Priority	Input
1	HDMI 1
2	HDMI 2
3	HDMI 3
4	HDMI 4
5	HDBT 5
6	HDBT 6
7	HDBT 7
8	HDBT 8

Figure 65: Routing Settings Page – HDBT Output Settings

2. Perform the following actions, as required:
  - Set **Audio only** to ON or OFF.
  - Change the **Port Label** name.
  - Check/uncheck **AFV**.
  - View the **Routing Status**.
  - Set **Extra Range** to ON or OFF.
  - Select a **Video Pattern**.
  - Open the **Auto Switching** drop-down box and select Manual, Priority or Last Connected switching, see [Auto Switching Feature](#) on page 48.
3. Click **Save**.

### Auto Switching Feature

For HDMI and HDBT outputs set **Auto Switching** to **Manual** (the default), **Priority** or **Last Connected**.



In both Last Connected and Priority modes, when the input signal sync is lost (but the cable is not removed) there is a default delay (see [Defining General Settings](#) on page 20) before another input is automatically selected. When an input cable is removed, there is a delay before automatic switching takes place.

In the Manual mode Video Lost timeouts are disabled.

### To use Auto Switching:

1. Open the HDMI/HDBT settings window.
2. If Auto Switching is set to Priority or Last Connected, you can do the following:
  - Drag and drop an input to set the priority order:

Auto Switching: Priority

Priority	Input	
drag & drop to order		
1	HDMI 2	X
2	HDMI 3	X
3	HDMI 4	X
4	HDMI 1	X
5	HDBT 5	X
6	HDBT 6	X
7	HDBT 7	X
8	HDBT 8	X
Add an input		

Cancel Save

Figure 66: Routing Settings Page –Priority Setup

- Delete input/s to exclude them from the priority list.

To add a deleted input, click **Add an Input** drop-down list and select the input/s.

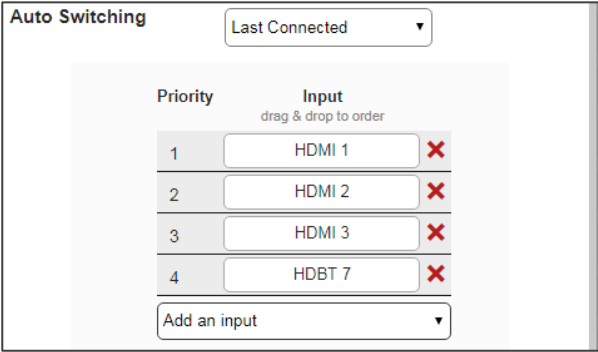

Figure 67: Routing Settings Page – HDMI/HDBT Priority List

3. Click **Save**.

Priority and Last Connected settings are indicated in the **Routing Settings** page as follows:

- The priority order numbers appear under output HDBT 6.
- Last Connected (**LC**) appears under outputs HDMI 3 and HDBT 5 (where input HDMI 3 was removed from the Last Connected list)

Outputs	HDMI 1	HDMI 2	HDMI 3	HDMI 4	HDBT 5	HDBT 6	HDMI 7
Inputs							
+ HDMI 1	✓	✓	✓ LC	○	✓ LC	✓ 2	○
+ HDMI 2	○	○	○ LC	🎵	○ LC	○ 1	○
+ HDMI 3	○	○	○ LC	📺	○	○ 3	✓
+ HDMI 4	○	○	○ LC	○	○ LC	○ 4	○
+ HDBT 5	○	○	○ LC	○	○ LC	○ 5	○

Figure 68: Routing Settings Page – Using Auto Switching

## Setting Analog and Amplified Audio Output Parameters

VS-88UT has two analog (1 to 2) outputs and one amplified audio output.



Figure 69: Port Settings – Audio Outputs

To set an audio output:

1. Click the audio icon (🔊).
2. Use the slider to set the audio volume, or click the 🔊 below to mute the audio output.

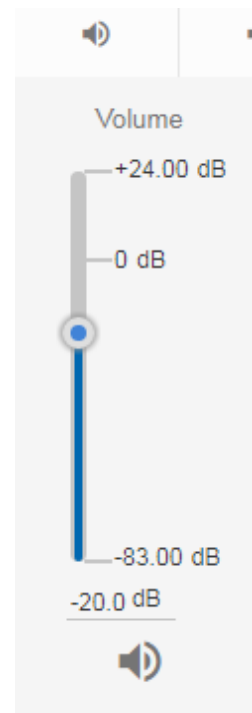

Figure 70: Audio Settings

## Setting and Routing the RS-232 Ports

RS-232 commands can be routed between HDBT inputs, HDBT outputs and the RS-232 DATA port (27).

To route RS-232, click a white routing button within the matrix. For example, to route RS-232 between input HDBT 7 and RS-232 DATA, click the routing button connecting them in the matrix:

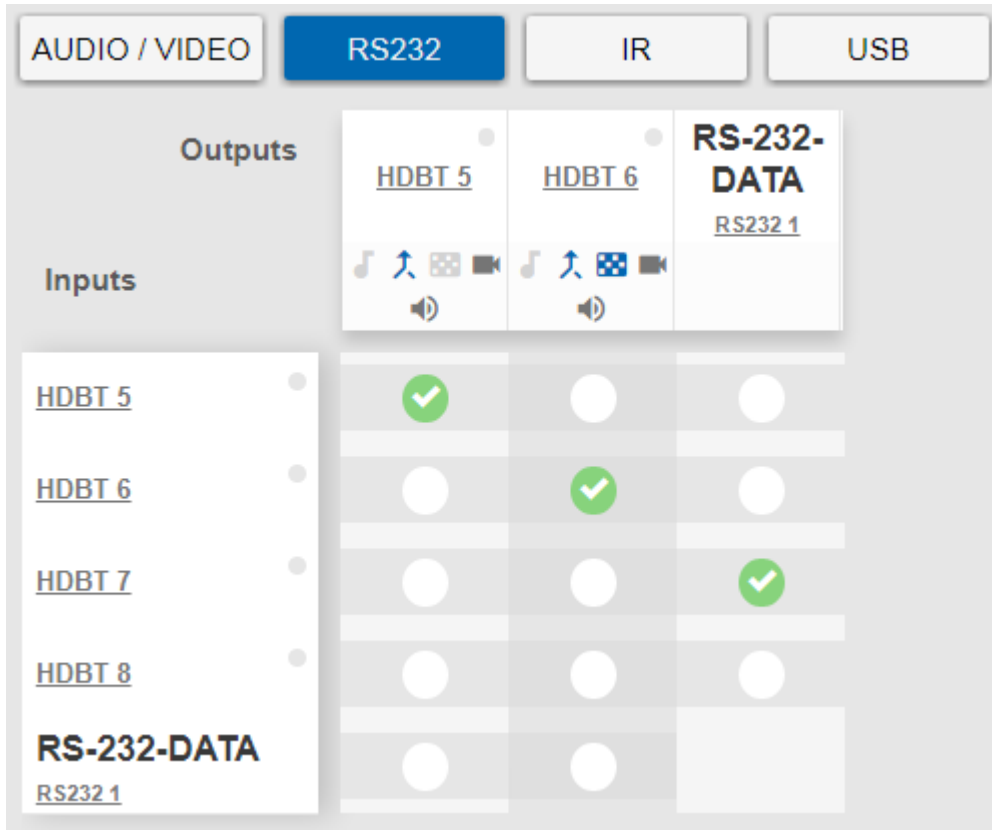

Figure 71: Routing Settings Page – RS-232 Routing

Click RS-232 1 on input or output to view the RS-232 routing status and change the port label (see also [Changing HDMI Input Port Settings](#) on page 29 and [Changing the HDBT Output Port Settings](#) on page 47).

## Setting and Routing IR Ports

IR commands can be routed between HDBT inputs, HDBT outputs, IR inputs (5 to 6) and IR outputs (5 to 8).

To route IR commands, click a white routing button within the matrix. For example, to route IR commands between input HDBT 6 and HDBT 5, click the routing button connecting them in the matrix:

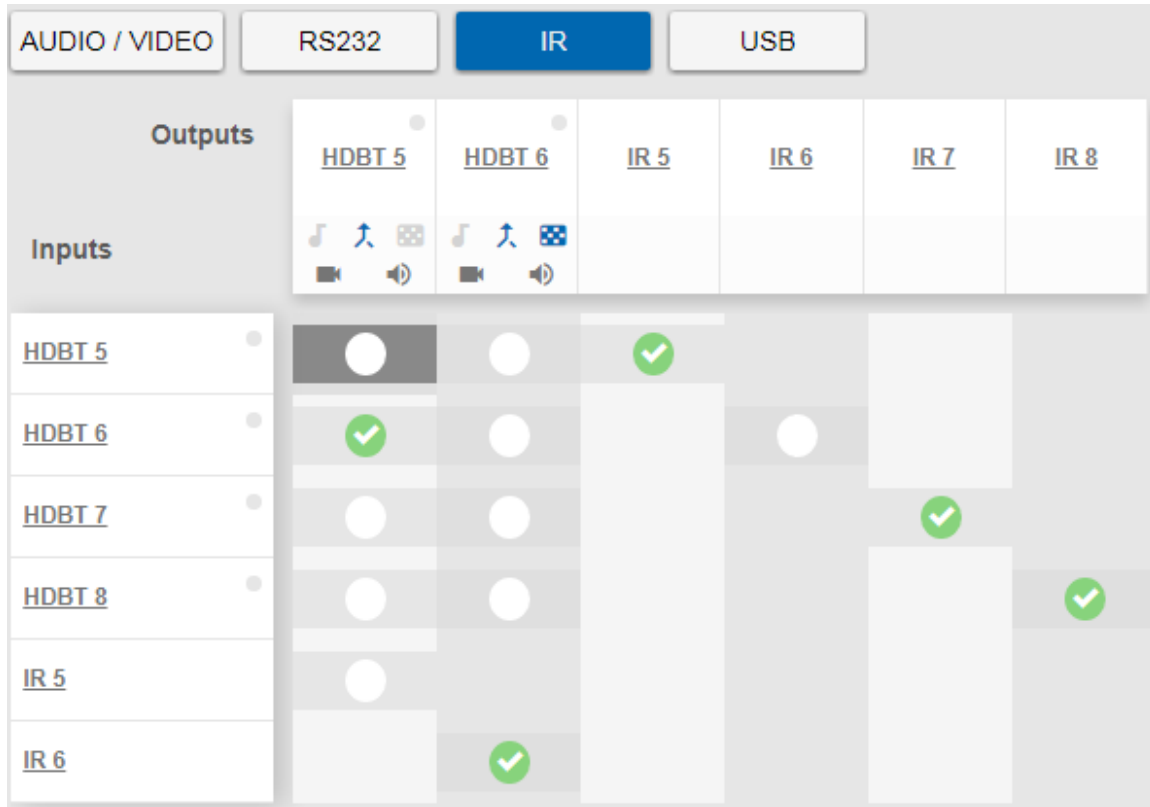

Figure 72: Routing Settings Page – IR Routing



IR 5 to IR 8 (in the Outputs row) enable connecting an external IR sensor/emitter to send/receive IR signals (5, 6, 7 and 8) via HDBT inputs 5, 6, 7 and 8 respectively.

IR 5 and IR 6 (in the Inputs column) enable connecting an external IR sensor/emitter to send/receive IR signals (5 and 6) via HDBT outputs 5 and 6, respectively.

Click IR inputs or outputs to view the IR routing status and change the port label (see also [Changing HDMI Input Port Settings](#) on page 29 and [Changing the HDBT Output Port Settings](#) on page 47).

## Setting and Routing the USB Ports

USB data can be routed between HDBT inputs, HDBT outputs and the USB Type-A hubs <sup>(29)</sup> and USB-Type-B ports <sup>(30)</sup>.

To route USB data, click a white routing button within the matrix. For example, to route USB data between input HDBT 6 and USB Type-A1 hub, click the routing button connecting them in the matrix:

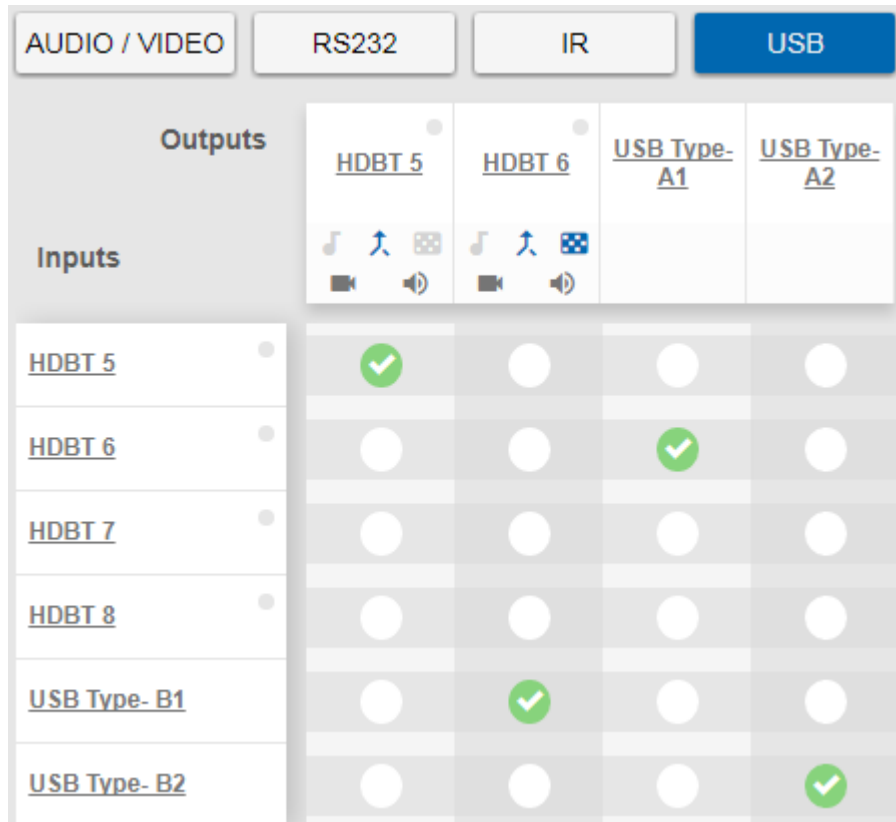

Figure 73: Routing Settings Page – USB Routing

Click an input, output or USB heading to view the USB routing status and other settings

Click USB Type B on inputs or USB Type A on outputs to view the USB routing status and change the port label (see also [Changing HDMI Input Port Settings](#) on page 29 and [Changing the HDBT Output Port Settings](#) on page 47).

# Controlling Devices via the Controller

You can control a large number of peripheral devices via the **VS-88UT** room controller section (VS-88UT-RC) via Kramer **K-Config 3**. See [Room Controller Functionality](#) on page [5](#).

Use the **Controller** page to:

- [Controlling Devices via the Controller](#) on page [54](#).
- [Activating Macros](#) on page [62](#).
- [Scheduling Macros](#) on page [63](#).
- [Setting the Date and Time](#) on page [65](#).

By default, the Controller page is empty, since a configuration is not yet synced to the device.

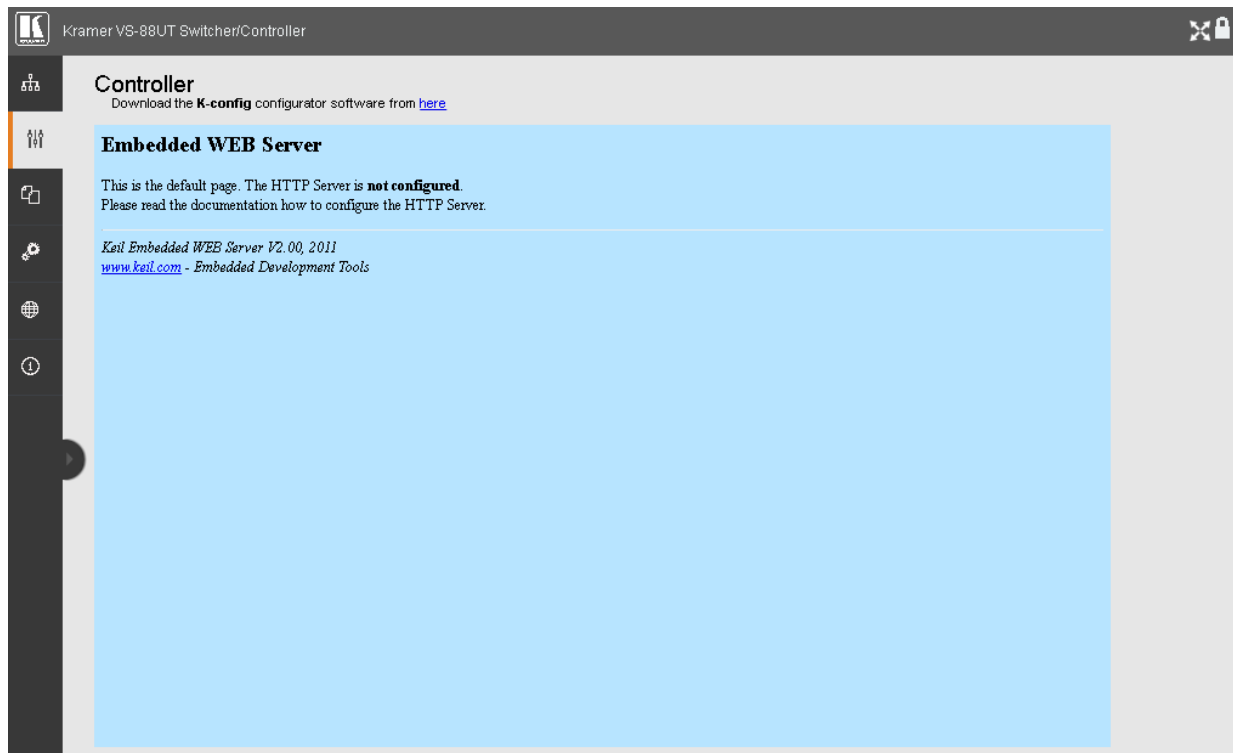

Figure 74: Controller Page – Default Page

**To activate the Controller page:**

- Click **here** to download K-Config 3.
- Create a room controller configuration via K-Config 3 and then sync the configuration to the device (see [Room Controller Configuration via K-Config 3](#) on page [55](#)).



## Room Controller Configuration via K-Config 3

Download the latest version of **K-Config 3** from our website at [www.kramerav.com/downloads/VS-88UT](http://www.kramerav.com/downloads/VS-88UT).

-  If you are new to **K-Config 3**, go to [www.kramerav.com/downloads/K-Config](http://www.kramerav.com/downloads/K-Config) to download the **K-Config 3** user manual.
-  In order to access **K-Config 3** via the Controller page, connect it to the network via TCP connection.

To create the room controller configuration:

1. In **K-CONFIG**, select VS-88UT-RC as the master device.

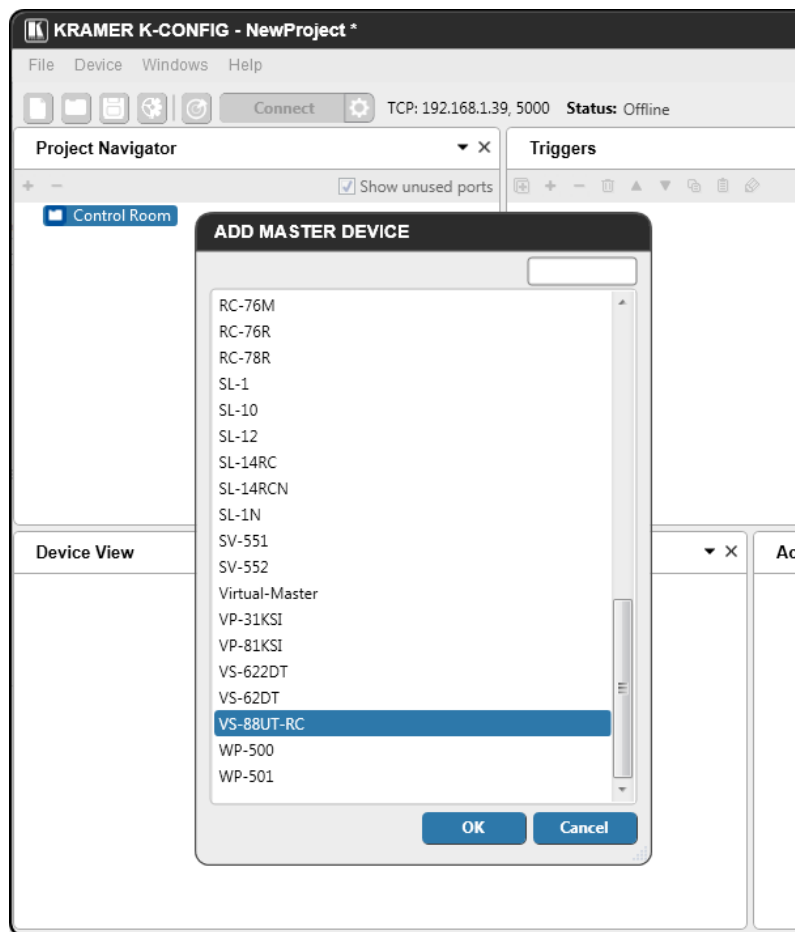

Figure 75: Controller Page – Select Master Device via K-CONFIG

2. Click **OK**.  
VS-88UT-RC is added as the Master controller with all its physical ports and virtual Ethernet ports.
3. Configure the ports and add peripheral devices, commands and macros as needed.
4. Save the project in **K-CONFIG**.

- In the **Windows** menu, select **Web Settings** and make sure that **Upload Web Access Pages to Device** is checked.

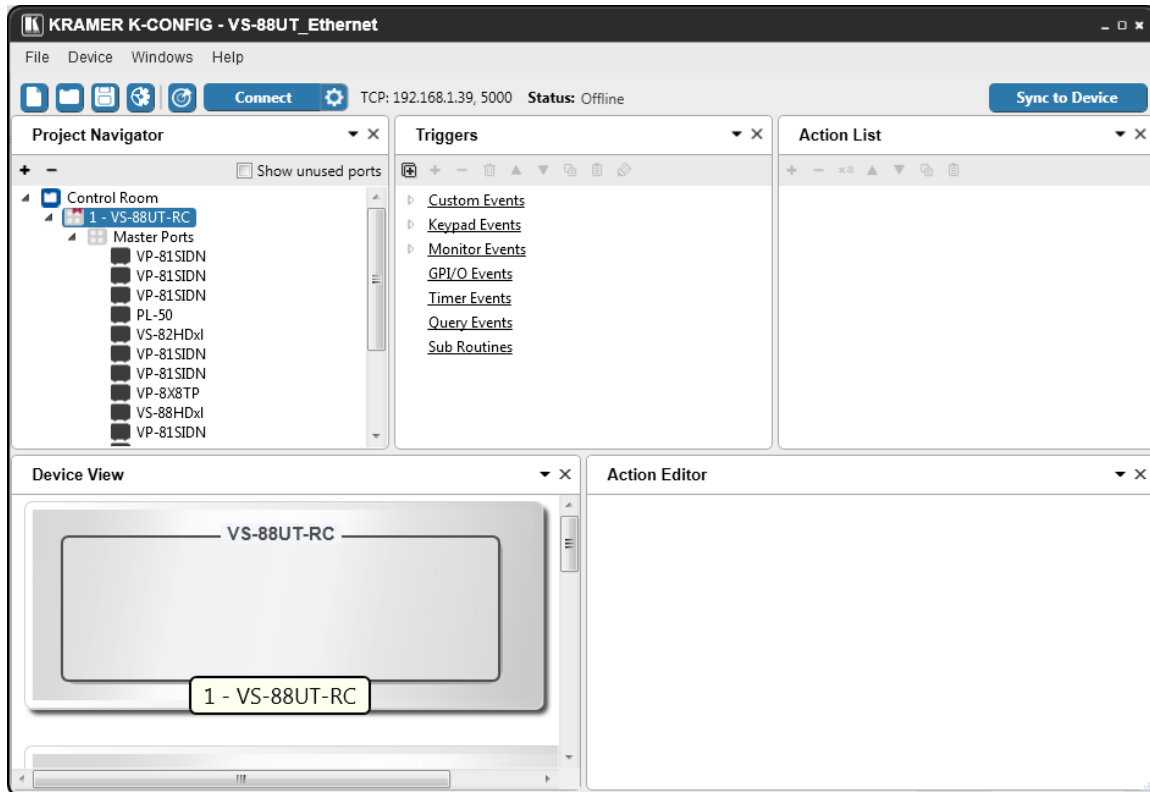

Figure 76: Controller Page – K-CONFIG Project

- Connect the **VS-88UT** to your PC (via Ethernet).
- Click **Connect** in **K-CONFIG**.  
The following message appears:

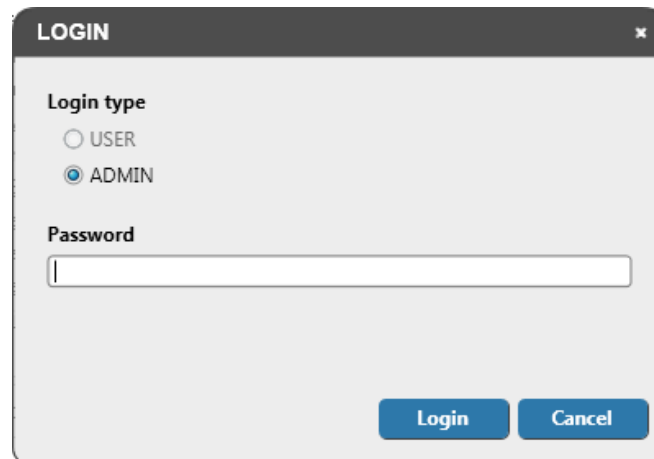

Figure 77: Controller Page – Login

- Type-in the **VS-88UT** webpage password for **ADMIN** (Admin, by-default).
- Click **Login**.  
**K-CONFIG** status displays **Online**.
- Click **Sync to Device**.  
The following message appears:

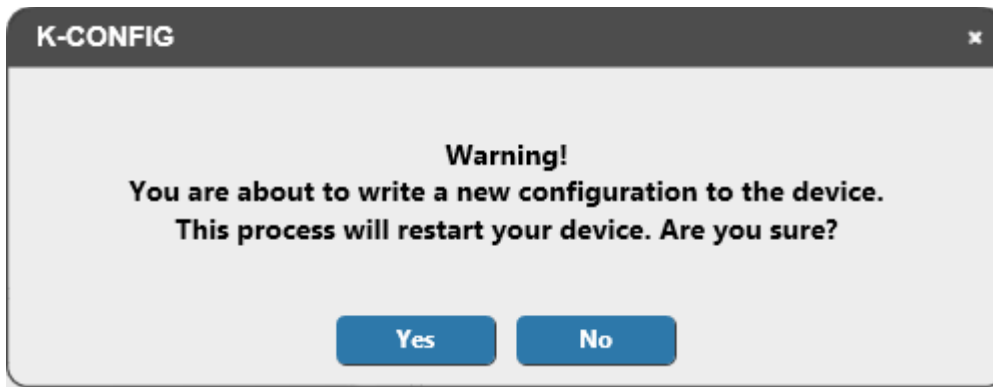

Figure 78: Controller Page – Writing to the Device

11. Click **Yes**.



This process may take a few minutes to complete.

12. Refresh the **VS-88UT** webpage.

13. In the Navigation pane, click **Controller**. The Log in window appears:

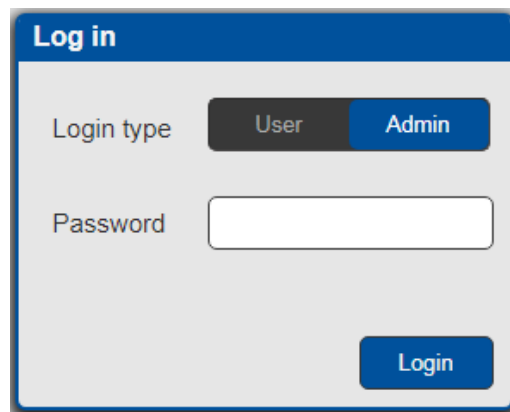

Figure 79: Controller Page – Log In Window

14. Set the Login type (**Admin** or **User**). For Admin, enter the password (Admin, by default).

15. Click **Login**.

The **Controller** page appears (see [Figure 80](#)).



If the Controller page does not load correctly (see [Figure 74](#)), you need to delete cached images and files and the refresh the Controller page.

---

## Controlling Devices

Devices that are connected to the **VS-88UT** room controller area are controlled via the **Controller** page once the configuration is uploaded.

The device menu enables:

- [Controlling a Peripheral Device](#) on page [58](#).
- [Controlling an Auxiliary Device](#) on page [60](#).
- [Controlling a Virtual Device](#) on page [61](#).

## Controlling a Peripheral Device

1. In the Controller page, click **Devices**.  
The Device menu appears:

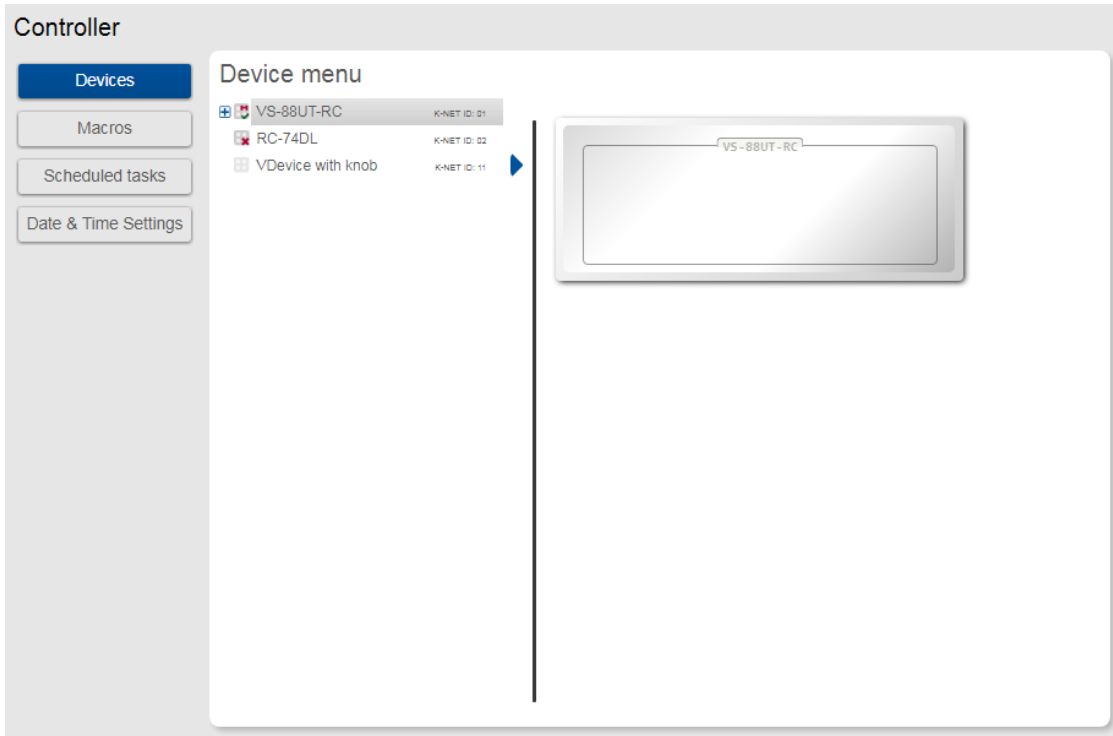

Figure 80: Controller Page – Device Menu

In this example, the Device menu list shows the room controller section (VS-88UT-RC), an auxiliary device (Kramer **RC-74DL**) and a virtual device.

2. Click **+** next to VS-88UT-RC to view the devices connected to the room controller:

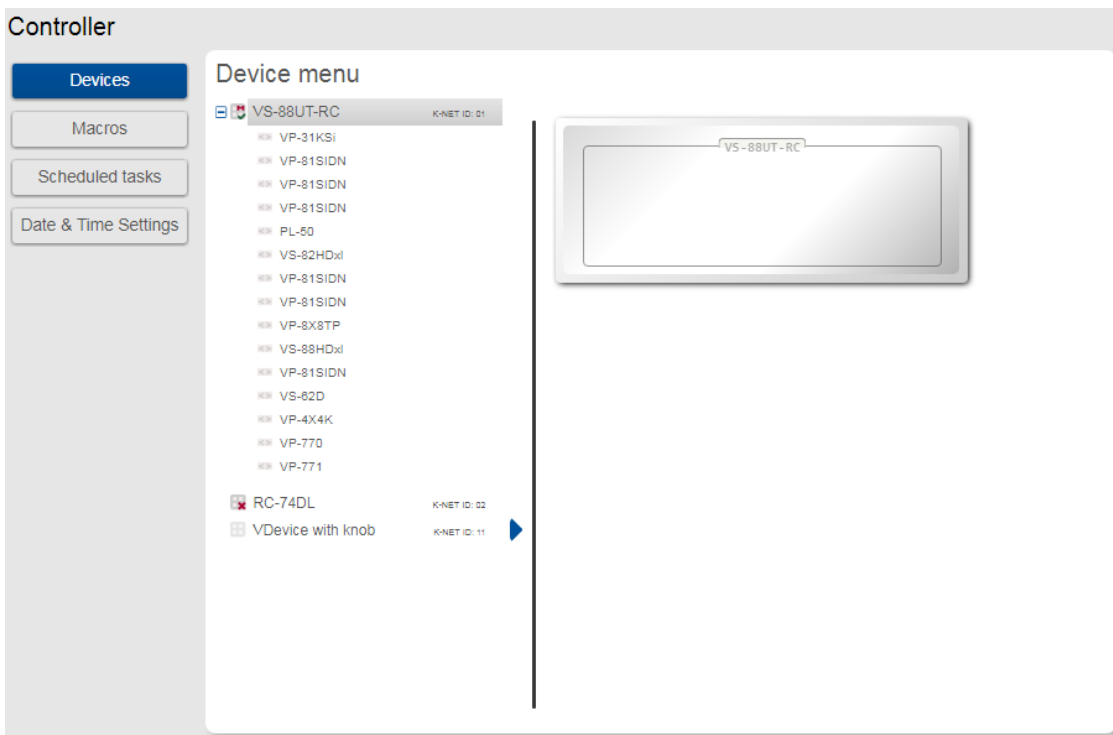

Figure 81: Controller Page – Peripheral Device List

3. Click a device to control it, for example, **VS-81SIDN**:

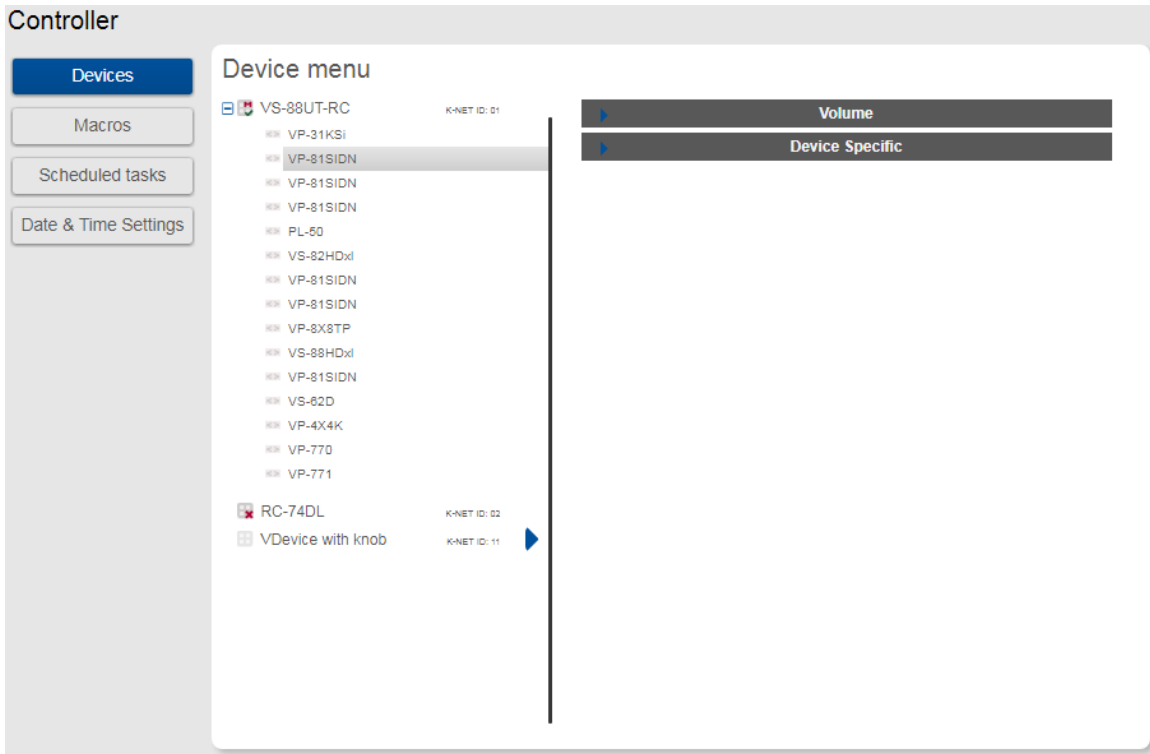

Figure 82: Controller Page – Controlling a Peripheral Device

4. Expand the command types:

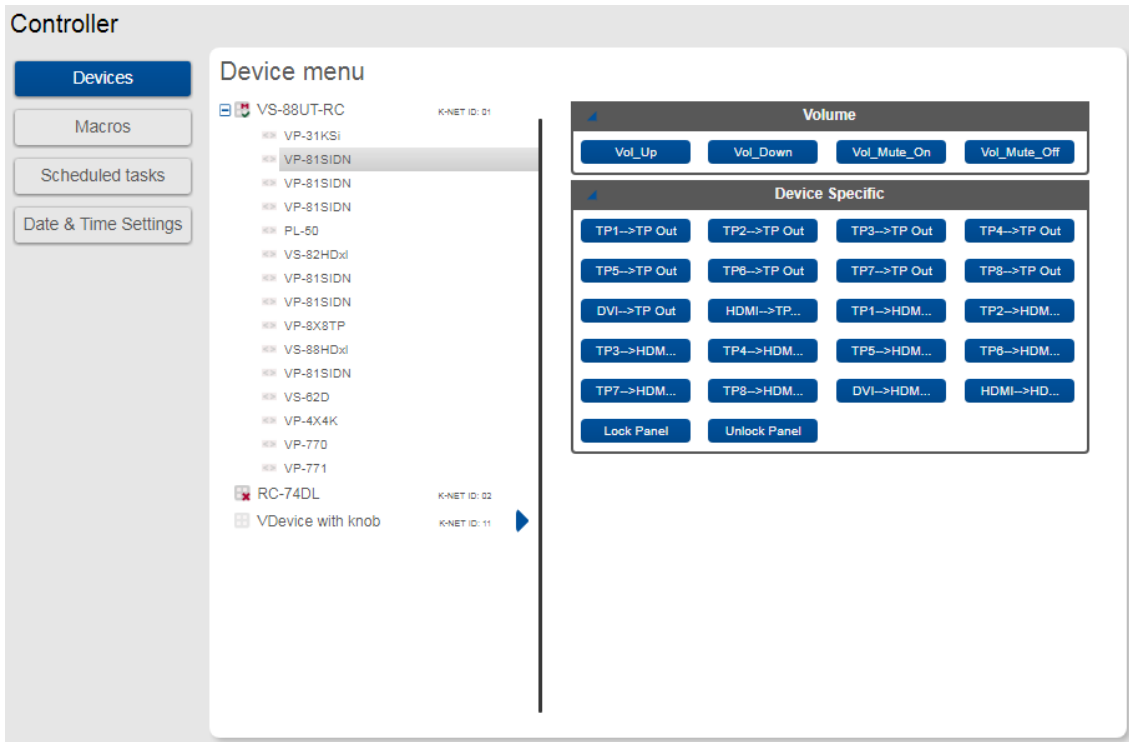

Figure 83: Controller Page –Peripheral Device Available Commands

The list of all the configured commands appears on the right-side of the page.

5. Click a command button.

The selected command is performed on the peripheral device.

## Controlling an Auxiliary Device

To control an auxiliary device:

1. In the Controller page, click **Devices**.
2. Click an Auxiliary device (**RC-74DL**).  
The Device menu appears:

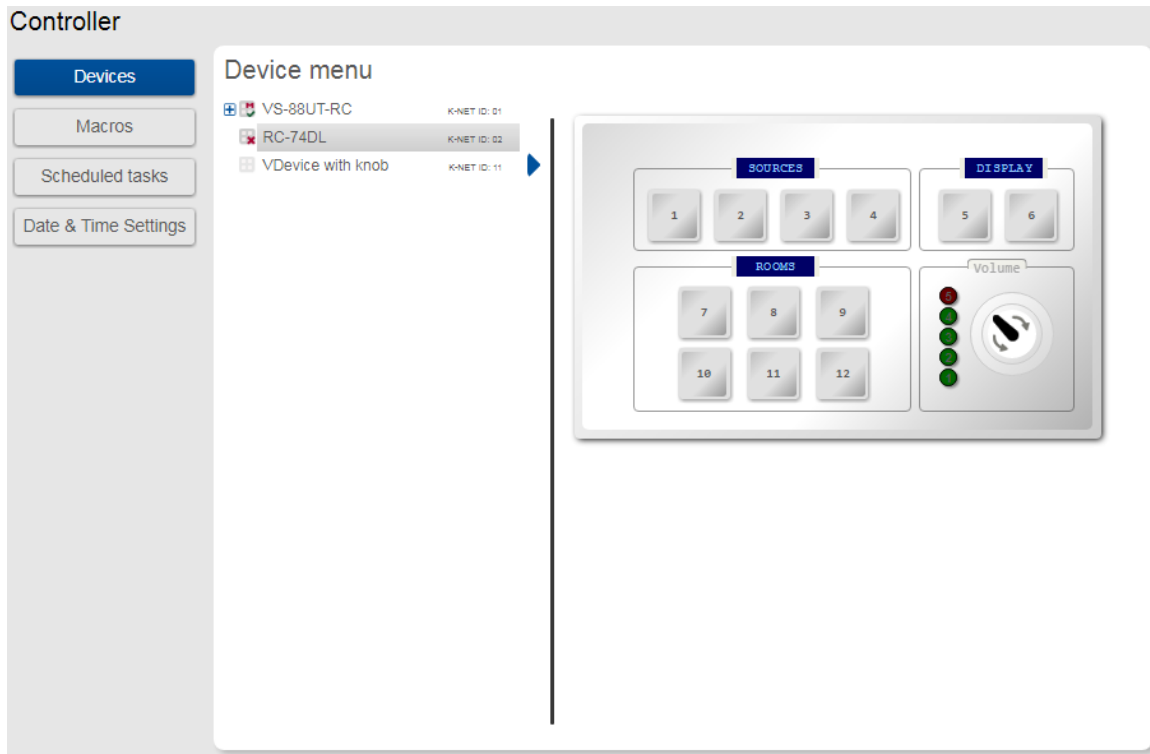

Figure 84: Controller Page – Controlling an Auxiliary Device

3. Click a room-controller device-button.  
The action list (as defined by **K-Config 3**) is performed.

## Controlling a Virtual Device

To control a virtual device:

1. In the Controller page, click **Devices**.  
The Device menu appears:
2. Click a virtual device on the list (for example, VDevice with Knob).  
The virtual device appears:

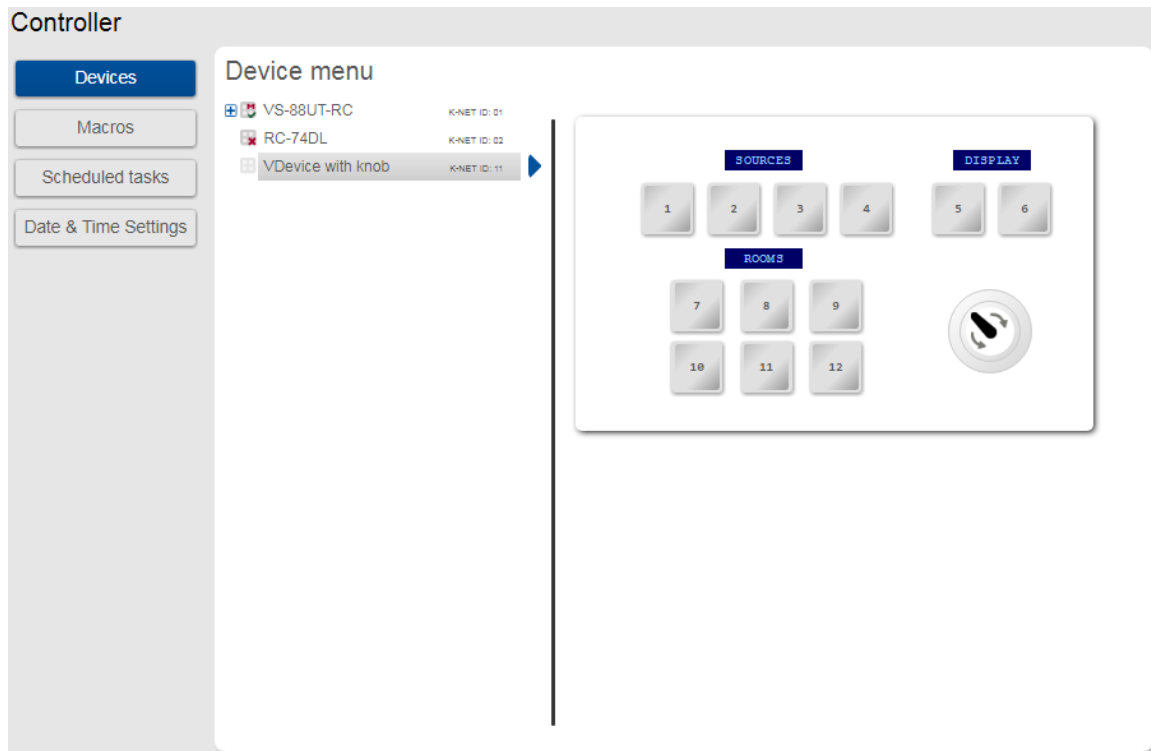

Figure 85: Controller Page – Controlling a Virtual Device

3. Click a room-controller device-button.  
The action list (as defined by **K-Config 3**) is performed.
4. If desired, click the blue arrow next to the virtual device for a full-page view (enables a clearer view when the virtual device includes several sets of device controllers).

## Activating Macros

Macros include **All Off** and **All On** buttons (configured in **K-CONFIG**) to easily activate or deactivate the controlled room with the press of a button.

1. In the Controller page click **Macros**.

The Macros window appears:

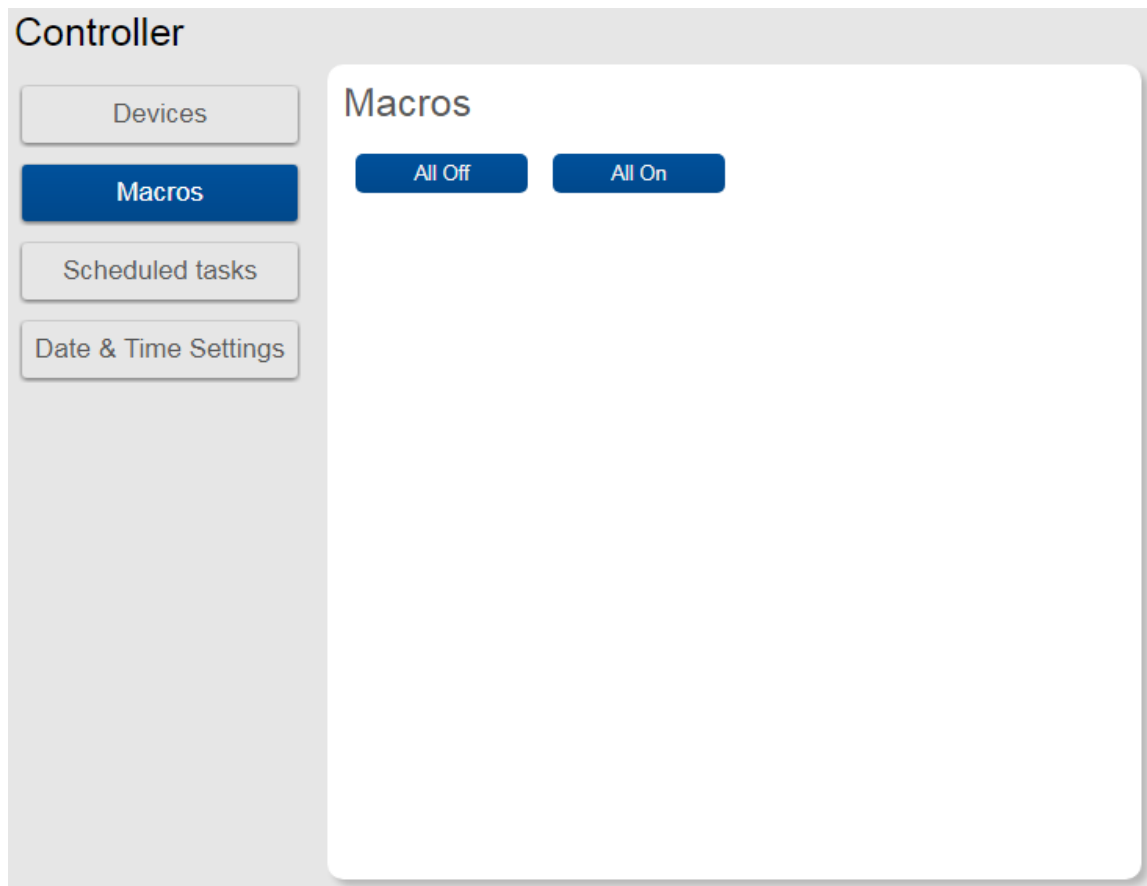

Figure 86: Controller Page – Macros Window

2. Click **All On** or **All Off** as required.



# Scheduling Macros

Scheduled tasks lets you schedule **All on/All Off** macros throughout the week.

- 1. In the Controller page click **Scheduled Tasks**.  
The Scheduled Tasks window appears:

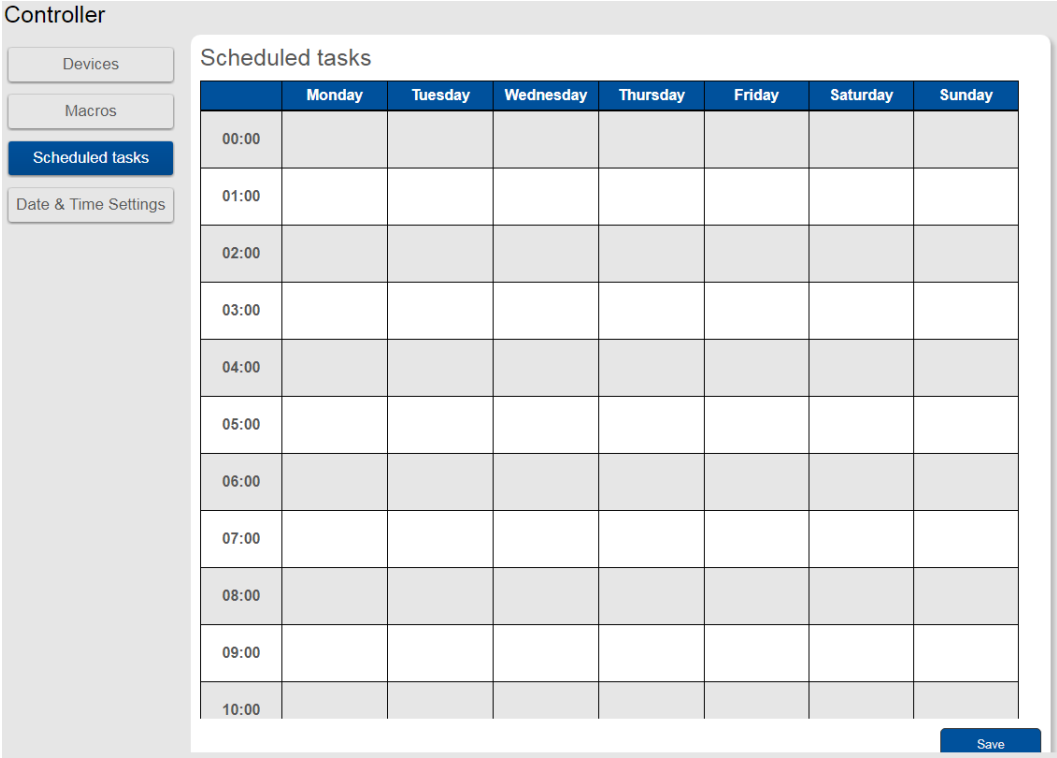

Figure 87: Controller Page – Scheduled Tasks

- 2. Hover over a day and time

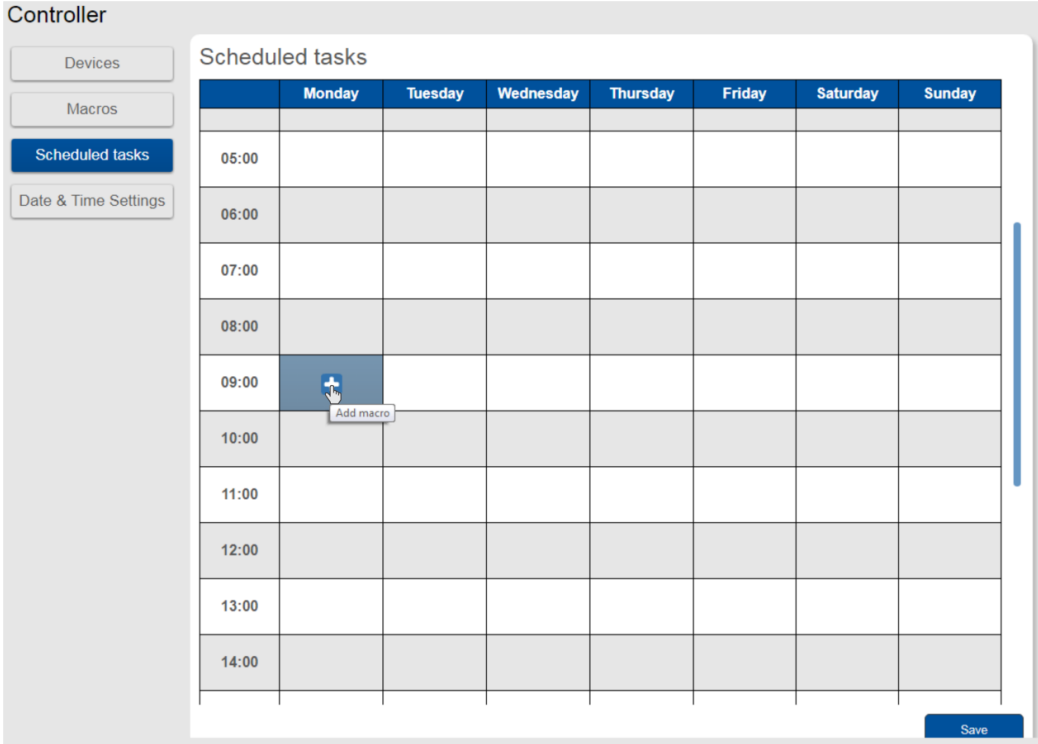

Figure 88: Controller Page – Selecting a Day and Time

- 3. Click **+**.  
The Add Macro window appears:

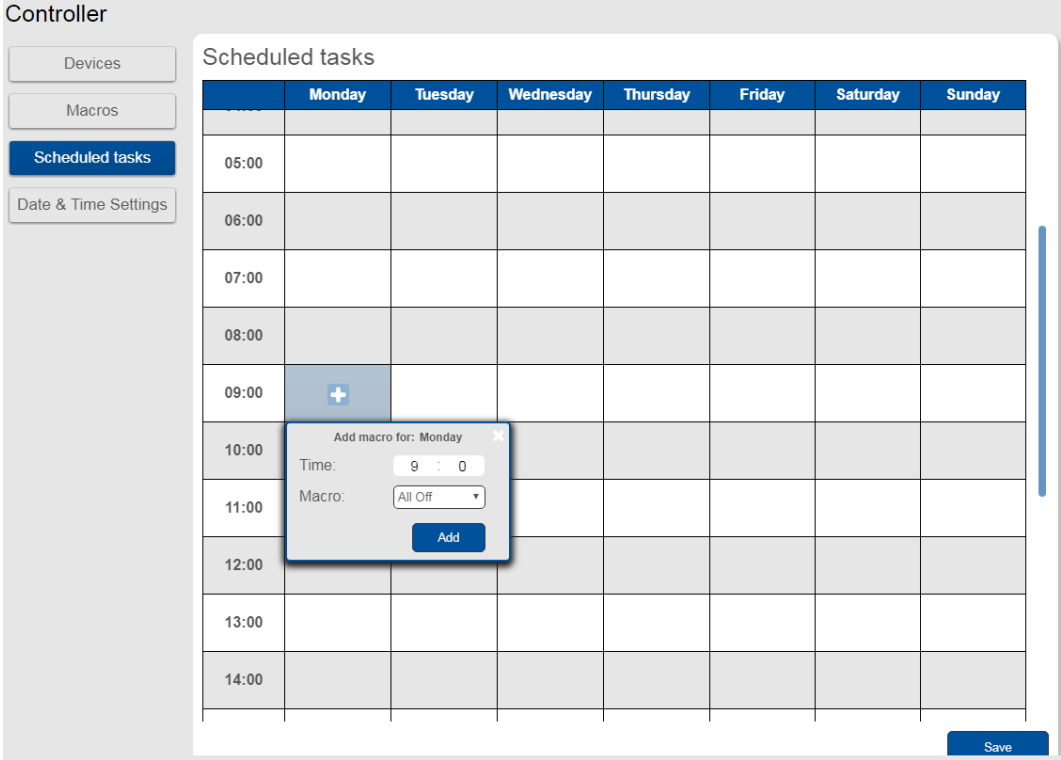

Figure 89: Controller Page – Adding a Scheduled Task

- 4. Select a Macro (All On or All Off), set the exact activation time and click **Add**.  
The scheduled macro appears in the table:

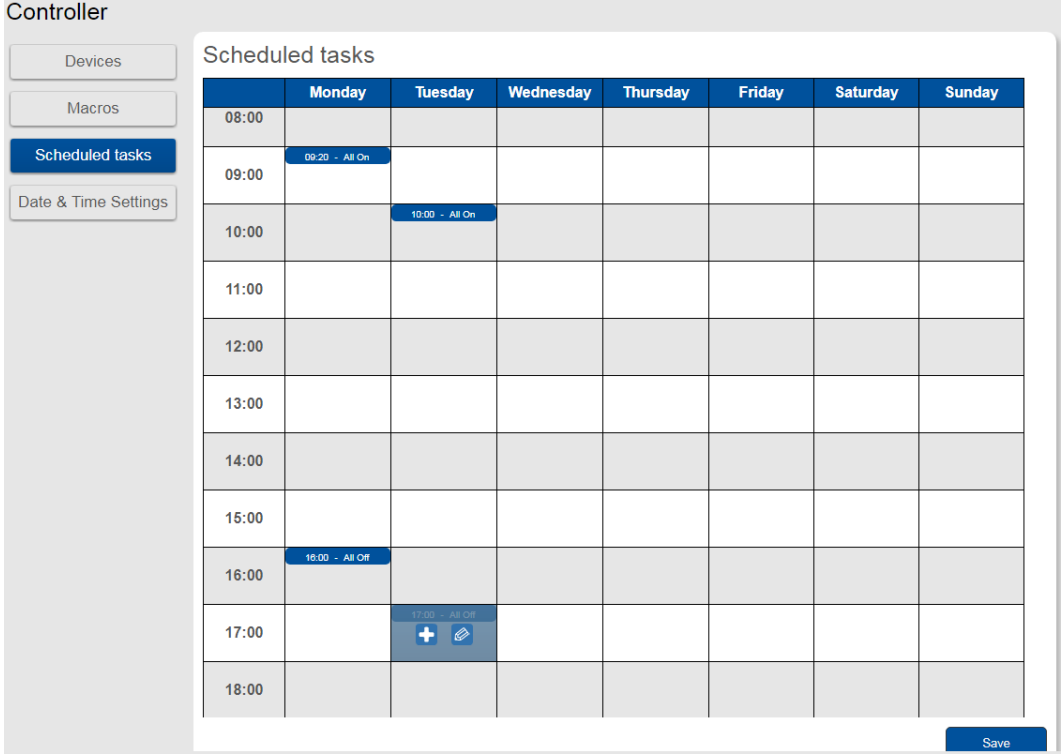

Figure 90: Controller Page – Scheduled Task Added

# Setting the Date and Time

Set the date and time in one of the following methods:

- Manually
- From a PC clock
- From a server address by clicking the IP address of the clock source, the time zone and checking DST if you are on Daylight Saving Time.

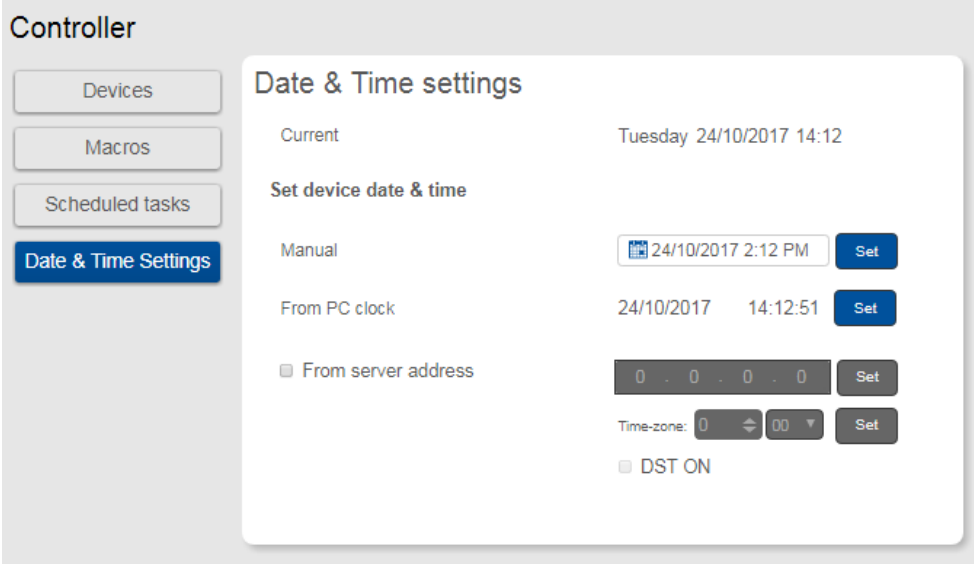

Figure 91: Controller Page – Date and Time Settings

# Managing EDID

The EDID page lets you read the EDID from:

- Any of the inputs.
- Any of the outputs.
- The default EDID.

You can also load a customized EDID file from your PC.

The selected EDID can be copied to the selected input/s.

 View the currently selected EDID source Bytemap by clicking **Bytemap** on the right side.

### To copy an EDID from an output to an input:

1. In the Navigation pane, click **EDID**. The EDID Management page appears.

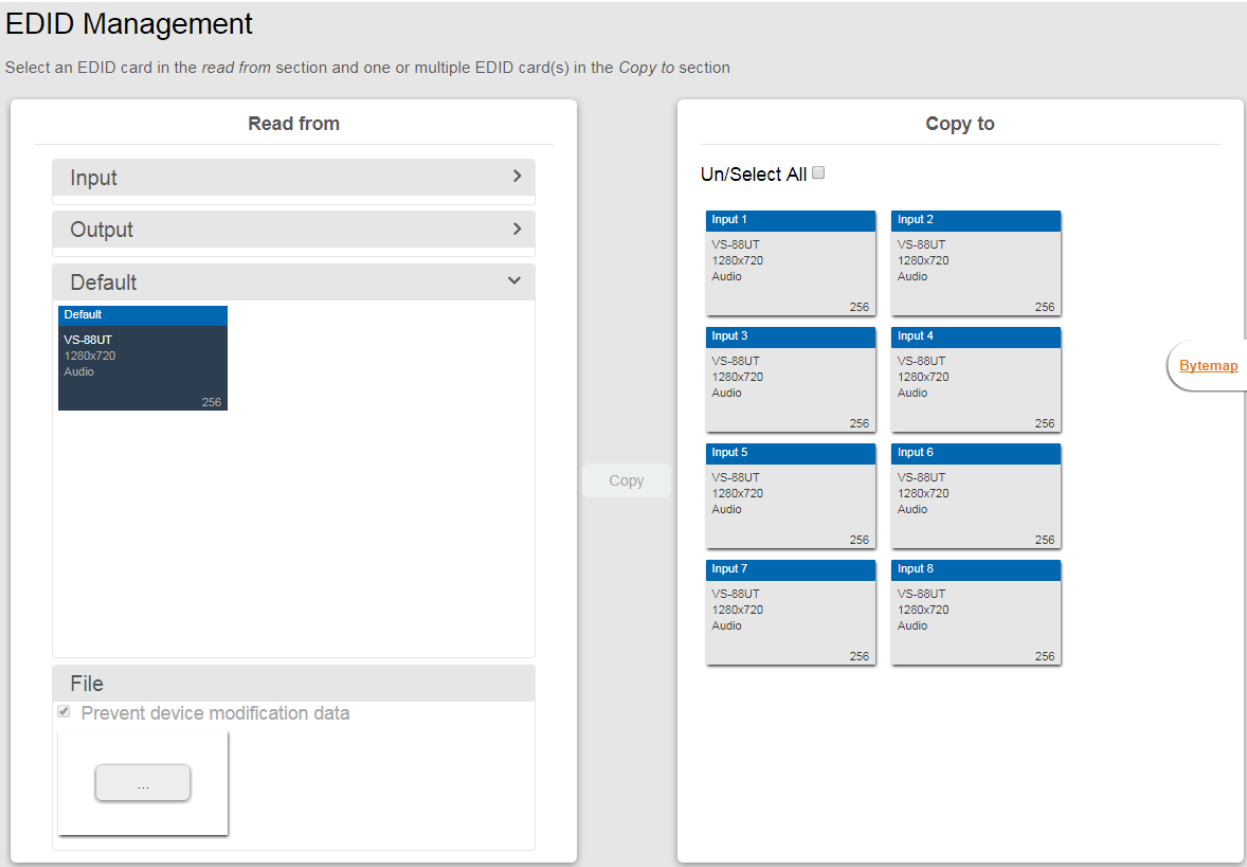

Figure 92: EDID Management Page

2. Select the EDID source (for example, one of the inputs).



If you are reading EDID from an output, make sure that that output is connected to an acceptor.

### EDID Management

Select an EDID card in the *read from* section and one or multiple EDID card(s) in the *Copy to* section

#### Read from

**Input** ▼

<b>Input 1</b> VS-88UT 1280x720 Audio 256	<b>Input 2</b> VS-88UT 1280x720 Audio 256
<b>Input 3</b> VS-88UT 1280x720 Audio 256	<b>Input 4</b> VS-88UT 1280x720 Audio 256
<b>Input 5</b> VS-88UT 1280x720 Audio 256	<b>Input 6</b> VS-88UT 1280x720 Audio 256

**Output** >

**Default** >

**File**

Prevent device modification data

...

#### Copy to

Un/Select All ☐

<b>Input 1</b> VS-88UT 1280x720 Audio 256	<b>Input 2</b> VS-88UT 1280x720 Audio 256
<b>Input 3</b> VS-88UT 1280x720 Audio 256	<b>Input 4</b> VS-88UT 1280x720 Audio 256
<b>Input 5</b> VS-88UT 1280x720 Audio 256	<b>Input 6</b> VS-88UT 1280x720 Audio 256
<b>Input 7</b> VS-88UT 1280x720 Audio 256	<b>Input 8</b> VS-88UT 1280x720 Audio 256

Copy

Bytemap

Figure 93: EDID Management Page – Select an EDID Input (Read From)

3. Select the input/s (or all the inputs) to which the EDID is copied.

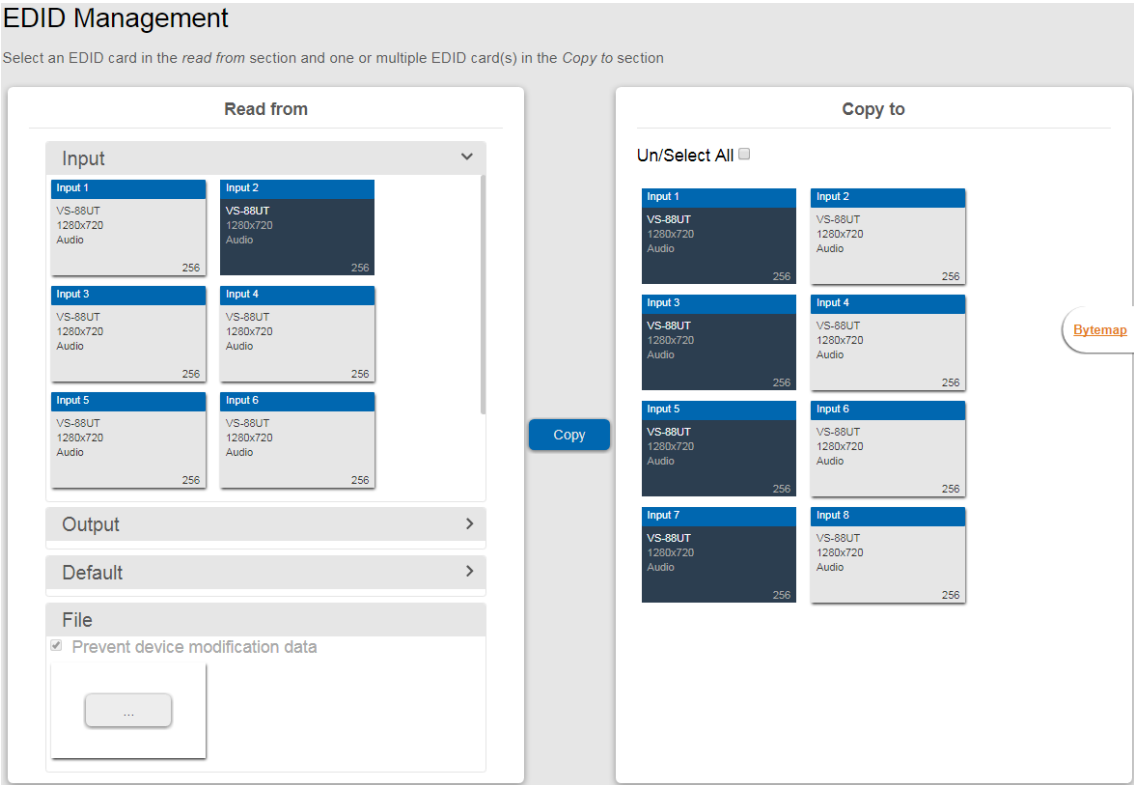

Figure 94: EDID Management Page – Select the Inputs (Copy To)

4. Click **COPY**.  
The Input 2 EDID is copied to the selected inputs.

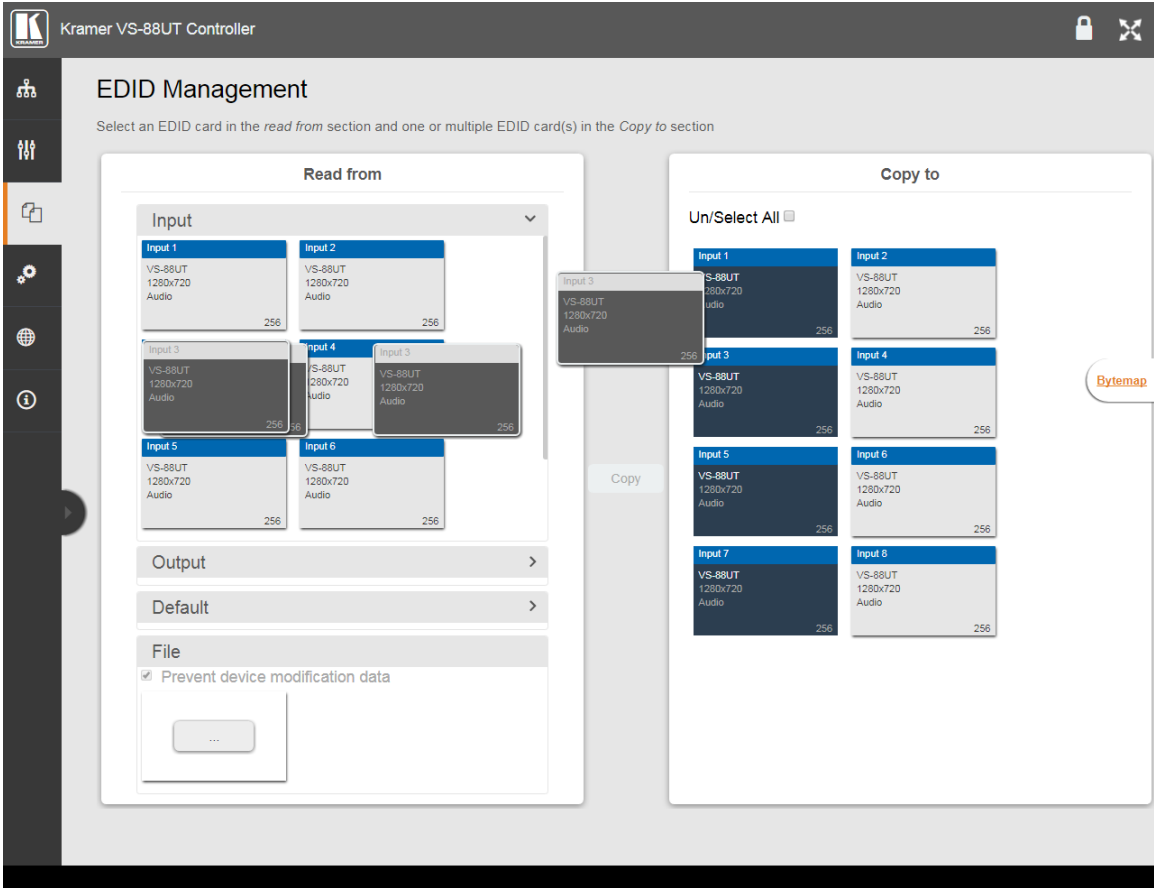

Figure 95: EDID Page – EDID Copied

The following message appears:

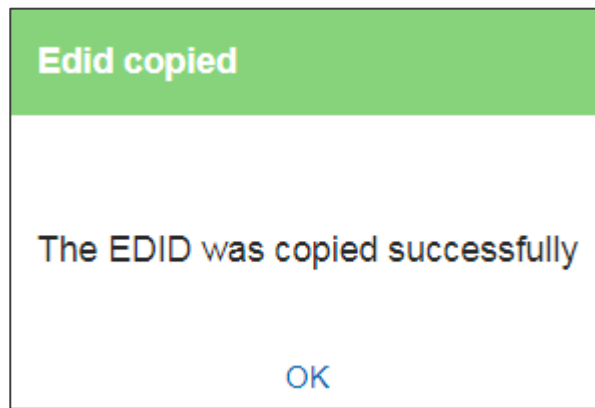

Figure 96: EDID Management Page – EDID Copy Success

5. Click **OK**.

**To read the EDID from the default EDID:**

1. In the Navigation pane, click **EDID**. The EDID Management page appears.
2. Click **Default**.
3. Select the input/s (or all the inputs) to which the default EDID is copied.
4. Click **Copy** and follow the instructions on-screen.

**To load a customized EDID file:**

1. In the Navigation pane, click **EDID**. The EDID Management page appears.
2. In the **File** area click ....
3. Select the EDID file.
4. Select the input/s (or all the inputs) to which the EDID is copied.
5. Click **Copy** and follow the instructions on-screen.

# Changing the Device Settings

The Device Settings Web page shows the device details such as name, MAC address and firmware version and also enables performing the following functions:

- Clicking **Restart** to restart the device.
- [Resetting to Factory Default Parameters](#) on page [70](#).
- Changing the **Device Name** by typing the new name and saving it.
- [Performing Firmware Upgrade](#) on page [71](#).
- [Setting Authentication](#) on page [72](#).

---

## Resetting to Factory Default Parameters

1. In the Navigation pane, click **Device Settings**. The Device Settings page appears:

Device Settings

Restart Factory reset

Device Name VS-88UT-1

Model VS-88UT

**Version**

Firmware version 01.01.0010 Upgrade...

**Security** ON OFF

[Change security properties](#)

Current Password

New Password

Confirm Password

Save

Figure 97: Device Settings Page



- 2. Click **Factory reset**.  
The following message appears:

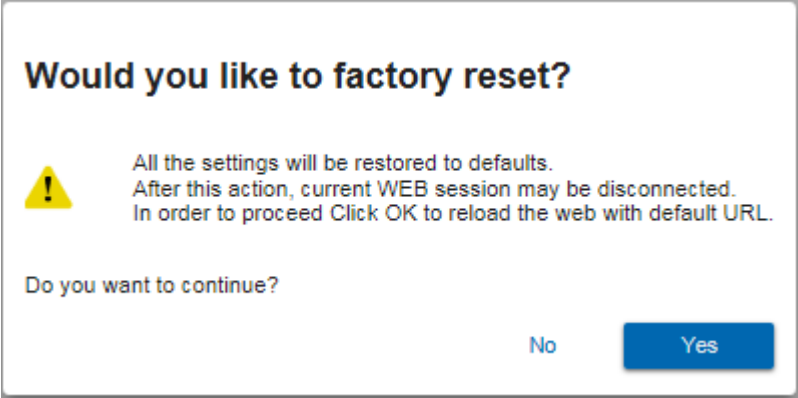

Figure 98: Device Settings Page – Factory Reset Message

- 3. Click **Yes** and follow the online instructions.

---

## Performing Firmware Upgrade

To perform firmware upgrade:

- 1. In the Navigation pane, click **Device Settings**. The Device Settings page appears.
- 2. Click **Upgrade** and select the new firmware file.  
The following message appears:

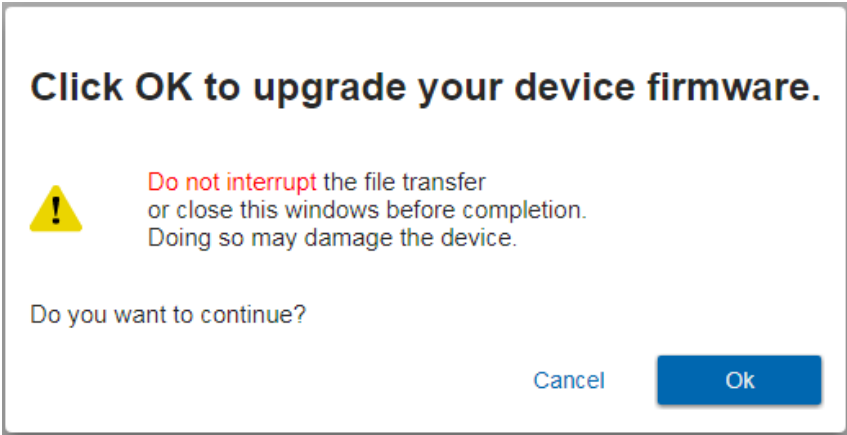

Figure 99: Device Settings Page – Firmware Upgrade Message

- 3. Click **OK**.  
Wait for completion of the upgrade process:

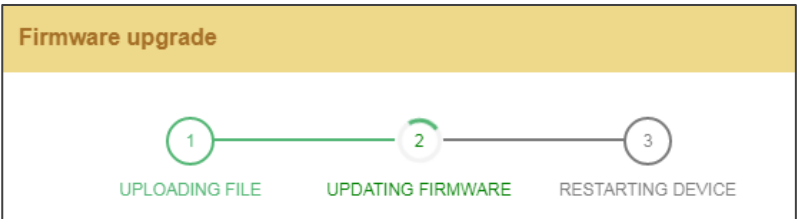

Figure 100: Device Settings Page – Firmware Upgrade Process

- 4. Wait for the device to restart.

## Setting Authentication

To define access to the Web pages In the Navigation pane, click **Device Settings**. The Device Settings page appears.

By default the Web pages are secured (user name and password are both: **Admin**).

**To access Web pages without using the password:**

1. Slide the Security switch to **OFF**.  
The following message appears:

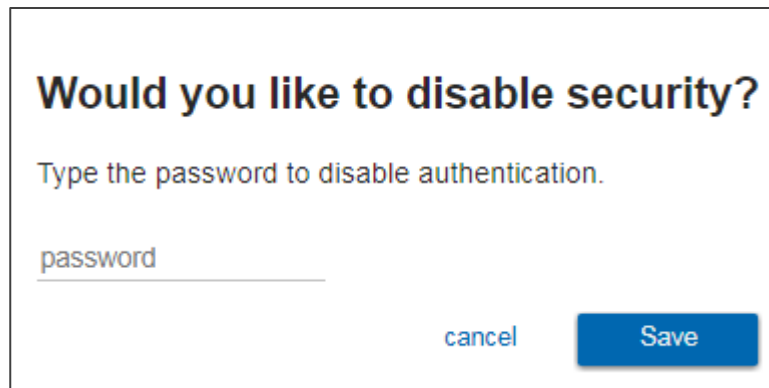

**Would you like to disable security?**

Type the password to disable authentication.

password

cancel Save

Figure 101: Password Settings Page – Disabling Authentication

2. Type the password and click **Save**.  
The device settings page no longer shows the authentication details:

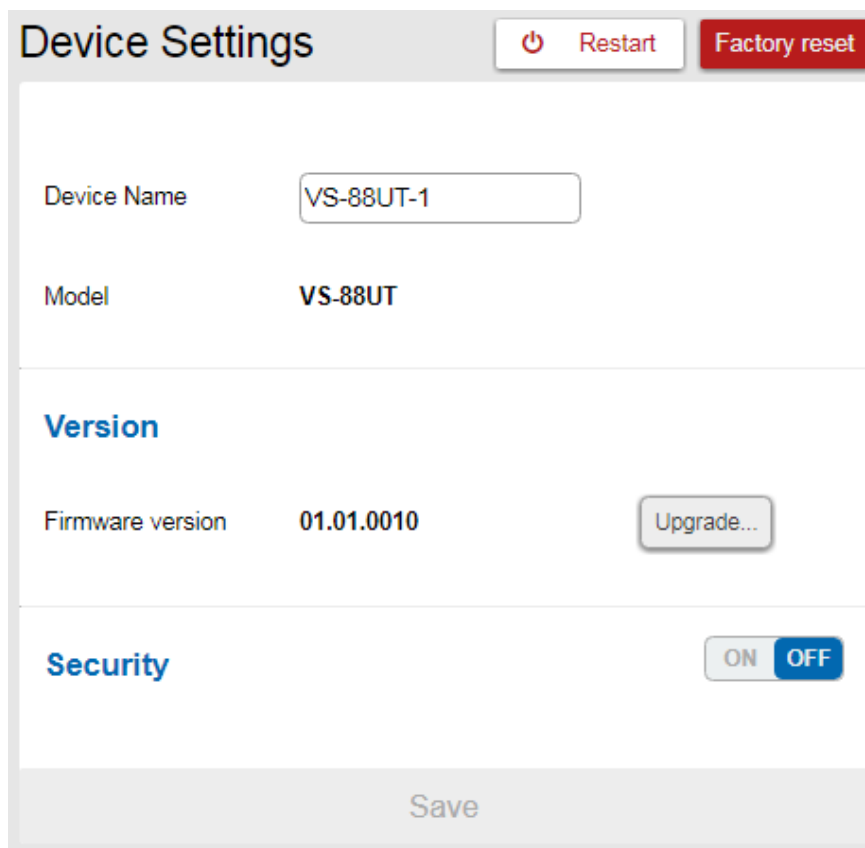

**Device Settings** Restart Factory reset

Device Name VS-88UT-1

Model VS-88UT

**Version**

Firmware version 01.01.0010 Upgrade...

**Security** ON OFF

Save

Figure 102: Password Settings Page –Security Deactivated

**To access Web pages using the password:**

- 1. Slide the security switch to **ON**.

The following message appears

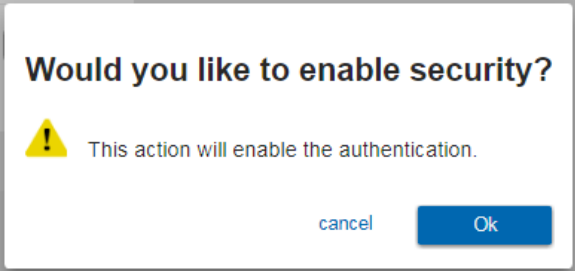

Figure 103: Password Settings Page – Activating Security

- 2. Click **Ok**, and add the password details.

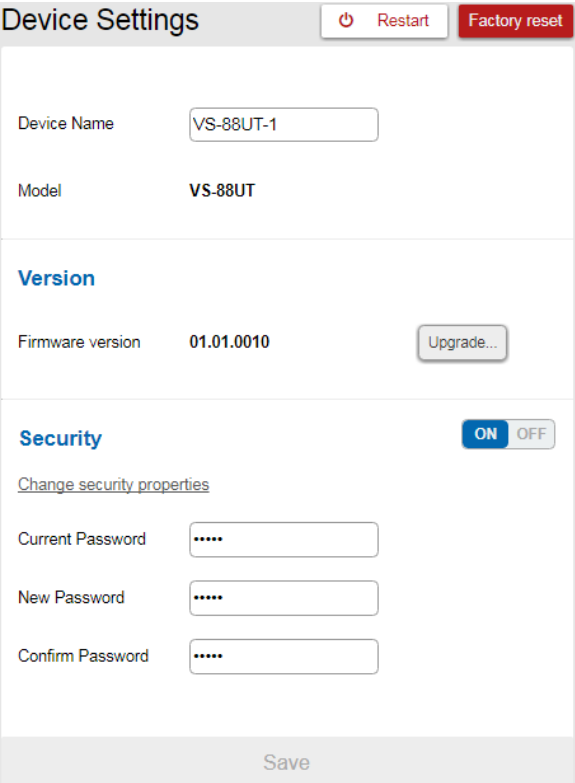

Figure 104: Password Settings Page – Security Activation Message

- 3. Click **Save**. The following message appears:

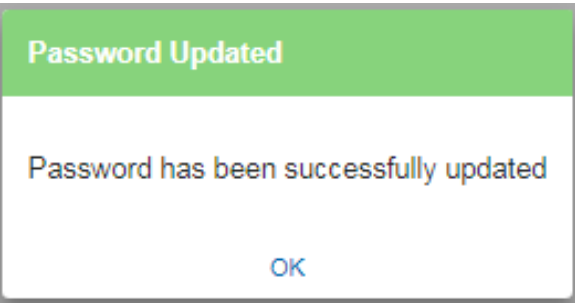

Figure 105: Password Settings Page – Password Updated

- 4. Click **OK**.

# Setting Network Parameters

The Network Settings Web page shows the device details, such as IP Address, Mask, MAC address and so on, and enables changing them.

## Changing the Ethernet Settings

To change the Ethernet settings:

1. In the Navigation pane, click **Network Settings**. The Network Settings page appears:

The screenshot shows the 'Network Settings' page with the following fields and values:

Parameter	Value
DHCP	OFF
IP Address	192 . 168 . 1 . 39
Mask	255 . 255 . 0 . 0
Gateway	192 . 168 . 0 . 1
Mac address	ec-24-b8-be-e5-50
TCP port	5000

A 'Save' button is located at the bottom of the form.

Figure 106: Network Settings Page

2. If DHCP is OFF, change any of the parameters (IP Address, Netmask and/or Gateway).
3. If required, change the TCP port number.
4. Click **Save**.



Note that:

- After changing the IP address, reload the Web page with the new IP address.
- After changing the Subnet mask, power cycle the **VS-88UT**.
- If DHCP is checked, reload the Web page with the new IP address (see below).

**To set parameters when DHCP is set to ON:**

1. In the Navigation pane, click **Device Settings**. The Device Settings page appears.
2. Take note the Device Name (you will need it later).
3. In the Navigation pane, click **Network Settings**. The Network Settings page appears.
4. Set DHCP to ON. The following message appears:

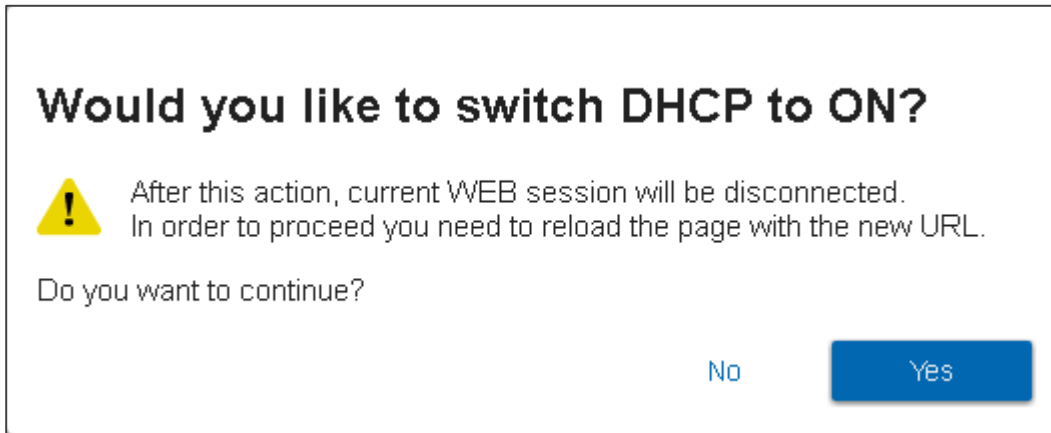

Figure 107: Network Settings Page

5. Click **Yes**.
6. Type the device name in the address bar of your browser to reload the page. You can read the new IP address from the Network Settings page.

# Viewing the About Page

The VS-88UT About page lets you view the Web page version and Kramer Electronics Ltd details.



Figure 108: About Page

# Technical Specifications

Inputs	<b>Matrix</b>	
	4 HDMI	On female HDMI connectors
	4HDBT/4HDMI (Selectable)	On RJ-45/female HDMI connectors
	4 Unbalanced Stereo Audio	On 3.5mm mini jacks
	4 Balanced Stereo Audio/8 Balanced Mic (Selectable)	On 5-pin/3-pin terminal block connectors
	4 IR	On 3.5mm mini jacks for IR tunneling via HDBT
	<b>Controller</b>	
	2 IR	On 3.5mm mini jacks
Outputs	<b>Matrix</b>	
	6 HDMI	On female HDMI connectors
	2 HDBT	On RJ-45 female connectors
	2 Balanced Stereo Audio	On 5-pin terminal block connectors
	1 Stereo Speaker Output, 2x50W into 4Ω or 2x30W into 4Ω	On a 4-pin terminal block connector
	2 IR	On 3.5mm mini jacks for IR tunneling via HDBT
Ports	<b>Matrix</b>	
	1 RS-232	On a 3-pin terminal block for serial tunneling via HDBT
	1 RS-232	On a 3-pin terminal block for device control
	4 USB (2x2)	On female USB-A connectors for USB link extension
	2 USB	On female USB-B connectors for USB link extension
	ETH Control	On a RJ-45 female connector
	ETH Data 1G	On an RJ-45 female connector
	1 100BaseT Ethernet	On an RJ-45 female connector for device control and LAN extension
	<b>Controller</b>	
	1 K-NET 5mm Mini-jack (For Learning).	On a 4-pin terminal block connector
	1 RS-485	On a 3-pin terminal block connectors
	4 RS-232 serial	On 3-pin terminal blocks
	8 Relays	on 2-pin terminal block connectors (36V AC or DC, 2A, 60VAC maximum on non-inductive load)
	4 GPI/O	On 2-pin terminal blocks
	1 Mini USB	Connector for programming services
	Extension Reach	4K @60Hz (4:2:0)
Full HD (1080p @60Hz 36bpp)		Up to 130m (430ft)
HDBaseT Ultra Mode and Full HD (1080p @60Hz 24bpp)		Up to 180m (590ft)
Compliance		HDBaseT 2.0

Controls	ON	LED indicator
	STATUS	LED indicator
	<b>Controller</b>	
	K-NET Termination	Switch (down for termination)
	RS-485 Terminator	Switch (down for termination)
	PROG	Switch (down for programming)
Video	Max Bandwidth	10.2Gbps (3.4Gbps per graphic channel)
	Max Resolution	4K @60Hz (4:2:0) 24bpp resolution
	Compliance	HDMI 2.0 and HDCP 1.4
Analog Audio	Max Level	1 Vrms
	THD + NOISE	0.03% @1kHz at nominal level
Extended USB	Host Compliance	1.1 and 2.0
	Max Extended Line Rate Bandwidth	127Mbps (out of max 480 USB)
	Max Devices	7
	Max Hubs	2
	Max Ports per Hub	8
Extended Ethernet	Max Transmission Bandwidth	100Mbps
Extended RS-232	Baud Rate	300 to 57600
Control RS-232	Baud Rate	115200
Supported PC Web Browsers	Windows 7 and Higher	Internet Explorer (32/64 bit) version 10 Firefox version 30 Chrome version 35
	MAC	Chrome version 35 Firefox version 30 Safari version 7
	Optimal Resolution	1920x1080
	Minimal Resolution	1024 x 768
Power	Consumption	250VA
	Source	100-240V AC, 50/60Hz
Cooling	Fan Ventilation	
Environmental Conditions	Operating Temperature	0° to +40°C (32° to 104°F)
	Storage Temperature	-40° to +70°C (-40° to 158°F)
	Humidity	10% to 90%, RHL non-condensing
Regulatory Compliance	Safety	CE, UL
	Environmental	RoHs, WEEE
Enclosure	Size	19", 9.3", 2U, rack mountable
	Type	Aluminum
General	Net Dimensions (W, D, H)	43.69cm x 18.4cm x 8.8cm (17.2" x 7.24" x 3.46")
	Shipping Dimensions (W, D, H)	55 cm x 34cm x 15.5cm (21.65" x 13.39" x 6.1")
	Net Weight	1.95kg (4.3lbs)
	Shipping Weight	2.75kg (6.1lbs) approx.
Accessories	Included	Power cord
	Optional	For optimum range and performance use the recommended USB, Ethernet, serial and IR Kramer cables available at <a href="http://www.kramerav.com/product/VS-88UT">www.kramerav.com/product/VS-88UT</a>
Specifications are subject to change without notice at <a href="http://www.kramerav.com">www.kramerav.com</a>		



## Default Communication Parameters

<b>RS-232</b>			
Protocol 3000			
Baud Rate:	115,200	Stop Bits:	1
Data Bits:	8	Parity:	None
Example (Set the volume on analog audio input 5 to 10dB):	#X-AUD-LVL IN.ANALOG_AUDIO.5.AUDIO.1,10		
<b>TCP/IP Parameters</b>			
IP Address:	192.168.1.39	UDP Port #:	50000
Subnet mask:	255.255.000.000	Maximum UDP Connections:	Unlimited
Default gateway:	192.168.0.1	Maximum TCP Connections:	70 (Web client not connected)
TCP Port #:	5000	Maximum TCP Connections:	10 (Web client connected)
<b>Full Factory Reset</b>			
Protocol 3000	Use "#FACTORY" command and use "#RESET" to restore the factory default values.		

# Protocol 3000

The **VS-88UT 8x8 HDMI/HDBT Matrix Switcher** can be operated using the Kramer Protocol 3000 serial commands. The command framing varies according to how you interface with the **VS-88UT**.

Generally, a basic video input switching command that routes a layer 1 video signal to HDMI out 1 from HDMI input 2 (ROUTE 1, 1, 2), is entered as follows:

- Terminal communication software, such as Hercules:

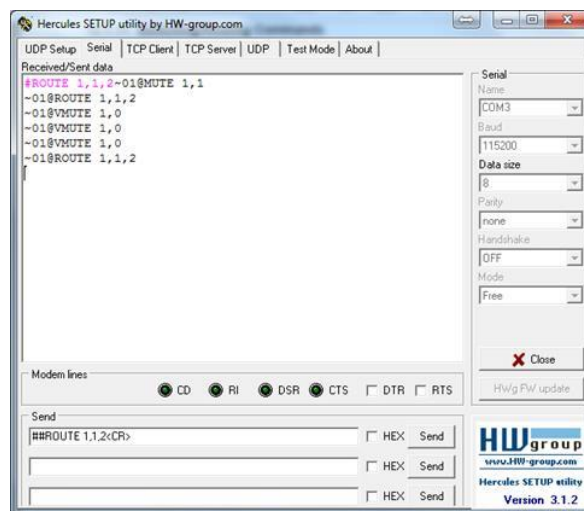

The framing of the command data varies according to the terminal communication software.

- K-Touch Builder (Kramer software):

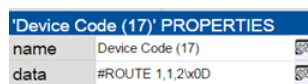

- K-Config (Kramer configuration software):



All the examples provided in this section are based on using the K-Config software.

You can enter commands directly using terminal communication software (e.g., Hercules) by connecting a PC to the serial or Ethernet port on the **VS-88UT**. To enter `CR` press the Enter key (`LF` is also sent but is ignored by the command parser).

Commands sent from various non-Kramer controllers (e.g., Crestron) may require special coding for some characters (such as, `/x##`). For more information, refer to your controller's documentation.

For more information about Protocol 3000 commands, see:

- [Understanding Protocol 3000](#) on page [81](#)
- [Kramer Protocol 3000 Syntax](#) on page [81](#)
- [Protocol 3000 Commands](#) on page [86](#)

---

## Understanding Protocol 3000

Protocol 3000 commands are structured according to the following:

- **Command** – A sequence of ASCII letters (A-Z, a-z and -). A command and its parameters must be separated by at least one space.
- **Parameters** – A sequence of alphanumeric ASCII characters (0-9, A-Z, a-z and some special characters for specific commands). Parameters are separated by commas.
- **Message string** – Every command entered as part of a message string begins with a message starting character and ends with a message closing character.



A string can contain more than one command. Commands are separated by a pipe ( | ) character.

- **Message starting character:**
  - # – For host command/query
  - ~ – For device response
- **Device address** – K-NET Device ID followed by @ (optional, K-NET only)
- **Query sign** – ? follows some commands to define a query request
- **Message closing character:**
  - CR – Carriage return for host messages (ASCII 13)
  - CR LF – Carriage return for device messages (ASCII 13) and line-feed (ASCII 10)
- **Command chain separator character** – Multiple commands can be chained in the same string. Each command is delimited by a pipe character ( | ). When chaining commands, enter the message starting character and the message closing character only at the beginning and end of the string.



Spaces between parameters or command terms are ignored. Commands in the string do not execute until the closing character is entered. A separate response is sent for every command in the chain.

---

## Kramer Protocol 3000 Syntax

The Kramer Protocol 3000 syntax uses the following delimiters:

- CR = Carriage return (ASCII 13 = 0x0D)
- LF = Line feed (ASCII 10 = 0x0A)
- SP = Space (ASCII 32 = 0x20)

Some commands have short name syntax in addition to long name syntax to enable faster typing. The response is always in long syntax.

The Protocol 3000 syntax is in the following format:

- **Host Message Format:**

Start	Address (optional)	Body	Delimiter
#	<i>Device_id@</i>	<b>Message</b>	<b>CR</b>

- **Simple Command** – Command string with only one command without addressing:

Start	Body	Delimiter
#	<b>Command</b> <b>SP</b> <i>Parameter_1,Parameter_2,...</i>	<b>CR</b>

- **Command String** – Formal syntax with command concatenation and addressing:

Start	Address	Body	Delimiter
#	<i>Device_id@</i>	<b>Command_1</b> <i>Parameter1_1,Parameter1_2,...</i> <b>Command_2</b> <i>Parameter2_1,Parameter2_2,...</i> <b>Command_3</b> <i>Parameter3_1,Parameter3_2,...</i> ...	<b>CR</b>

- **Device Message Format:**

Start	Address (optional)	Body	Delimiter
~	<i>Device_id@</i>	<b>Message</b>	<b>CR</b> <b>LF</b>

- **Device Long Response** – Echoing command:

Start	Address (optional)	Body	Delimiter
~	<i>Device_id@</i>	<b>Command</b> <b>SP</b> <i>[Param1 ,Param2 ...]</i> <b>result</b>	<b>CR</b> <b>LF</b>

---

## Extended Protocol 3000

In addition to the standard Protocol 3000 syntax, newer Kramer products use extended syntax to improve user experience and provide easier deployment and configuration.

For products with many ports and of different types, the extended syntax describes commands and their parameters in a more intuitive, user-friendly format.

To identify devices supporting extended commands, use the #HELP command to list all supported commands. Commands that begin with the prefix 'X-' use extended Protocol 3000 syntax. Extended commands use Port ID (see [Port ID Format](#) on page 83) and Signal ID (see [Signal ID Format](#) on page 84) instead of the old port naming parameters.

## Port ID Format

The port ID is composed of three fields separated by a dot ‘.’ (`<direction_type>.<port_type>.<port_index>`), where:

- `<direction_type>` – specifies the direction of the port (see [Direction Types](#) on page [83](#)).
- `<port_type>` – identifies the port type (see [Port Types](#) on page [84](#)).
- `<port_index>` – is a port index that always matches the port number printed on the front or rear panel of the product.

Examples:

`IN.SDI.1` (refers to SDI input port 1)

`OUT.HDMI.4` (refers to HDMI output port 4)

`BOTH.RS232.2` (refers to bidirectional RS-232 port 2)

## Direction Types

The string representation is not case sensitive.

String	Meaning
IN	Input port
OUT	Output port
BOTH	Bi-directional port where the direction has no meaning

## Port Types

The string representation is not case sensitive.

String	Meaning
HDMI	HDMI port
HDBT	HDBaseT port
SDI	Any serial digital SDI port
ANALOG_AUDIO	Any balanced or unbalanced audio ports
AMPLIFIED_AUDIO	Any analog outputs defined as amplified audio
MIC	Any microphone port including a balanced audio input port divided into left/right
RS232	Local control port used for data control
IR	Local IR input
USB_A	Local USB port of type-A (client)
USB_B	Local USB port of type-B (host)

## Signal ID Format

The signal ID is composed of three fields separated by a dot '.'

(<port\_id>.<signal\_type>.<index>), where:

- <port\_id> – Indicates the port ID, as described in [Port ID Format](#) on page 83.
- <signal\_type> – Indicates the type of signal, as described in [Extended Signal Types](#) on page 84.
- <index> – Indicates a specific channel number when there are multiple channels of the same type

Signal ID: <port\_id>.<signal\_type>.<index>

also means: <<direction\_type>.<port\_type>.<index>>.<signal\_type>.

<channel\_index>

Examples:

IN.HDMI.1.VIDEO.1 (refers to video channel 1 of HDMI input port 1)

OUT.HDBT.1.AUDIO.1 (refers to audio channel 1 of HDBaseT output port 1)

## Extended Signal Types

The string representation is non-case sensitive.

String	Meaning
VIDEO	Video signal of the port
AUDIO	Audio signal of the port
RS232	Data signal of the port (relevant for HDBT and RS-232 ports for example)
IR	IR signal of the port (relevant for HDBT and IR ports for example)
USB	USB signal of the port (relevant for HDBT and USB_A/B ports for example)

## Examples

To understand the advantages of the extended Protocol 3000 syntax, compare the standard `MUTE` and `VMUTE` command syntax with the extended `X-MUTE` command syntax.

`MUTE` and `VMUTE` are dedicated commands to mute audio and video respectively. Both commands receive the index of the output to mute as a parameter. Two separate commands are used to mute different signal types and neither command enable muting the inputs and not the outputs.

However, the `X-MUTE` command can mute audio and/or video on either inputs or outputs:

- Mute video on output 1: `#X-MUTE OUT.HDMI.1.VIDEO.1`
- Mute audio on output 1: `#X-MUTE OUT.HDMI.1.AUDIO.1`
- Mute video on input 1: `#X-MUTE IN.HDMI.1.VIDEO.1`
- Mute audio on input 1: `#X-MUTE IN.HDMI.1.AUDIO.1`

The name of the action remains the same and what it affects is passed in parameters.

In another example, the `#ROUTE` command is extended by the command `#X-ROUTE`:

- To route a video signal to HDBT output #4 from HDMI input #1:  
`#X-ROUTE OUT.HDBT.4.VIDEO.1,IN.HDMI.1.VIDEO.1`  
`~01@X-ROUTE OUT.HDBT.4.VIDEO.1,IN.HDMI.1.VIDEO.1`
- To route an audio signal to analog output #1 from the HDMI input #1:  
`#X-ROUTE OUT.ANALOG_AUDIO.1.AUDIO.1,IN.HDMI.1.AUDIO.1`  
`~01@X-ROUTE OUT.ANALOG_AUDIO.1.AUDIO.1,IN.HDMI.1.AUDIO.1`

---

## Other Rules

In routing commands, first specify the target output(s), then the source input.

**Example:** `#X-ROUTE OUT.ANALOG_AUDIO.1.AUDIO.1,IN.HDMI.1.AUDIO.1`

Brackets '[' and ']' are reserved Protocol 3000 characters that define a list of parameters as in [a,b,c,d].

**Example:** to route video input 3 to outputs 1,4,6,7: `ROUTE 1, [1,4,6,7], 3<cr>`

**Example illustrating brackets and commas:**

`#SIGNALS-LIST?`

`~01@SIGNALS-LIST`

`[IN.SDI.1.VIDEO.1,IN.SDI.2.VIDEO.1,IN.SDI.3.VIDEO.1,IN.SDI.4.VIDEO.1,IN.SDI.5.VIDEO.1,IN.SDI.6.VIDEO.1,IN.SDI.7.VIDEO.1,IN.SDI.8.VIDEO.1,OUT.SDI.1.VIDEO.1,OUT.SDI.2.VIDEO.1,OUT.SDI.3.VIDEO.1,OUT.SDI.4.VIDEO.1,OUT.SDI.5.VIDEO.1,OUT.SDI.6.VIDEO.1,OUT.SDI.7.VIDEO.1,OUT.SDI.8.VIDEO.1]`

## Protocol 3000 Commands

This section includes the following commands:

- [Common Commands](#) on page [86](#).
- [System Commands](#) on page [90](#).
- [Authentication Commands](#) on page [97](#).
- [EDID Handling Commands](#) on page [98](#).
- [Switch Commands](#) on page [100](#).
- [Routing Commands](#) on page [101](#).
- [Audio Commands](#) on page [106](#).
- [Video Commands](#) on page [108](#).
- [Global Mute Command](#) on page [111](#).
- [Communication Commands](#) on page [112](#).

### Common Commands

Command	Description
#	Protocol handshaking (system mandatory)
BUILD-DATE	Get device build date (system mandatory)
FACTORY	Reset to factory default configuration
HELP	Get command list (system mandatory)
MODEL?	Get device model (system mandatory)
PROT-VER?	Get device protocol version (system mandatory)
RESET	Reset device (system mandatory)
SN?	Get device serial number (system mandatory)
VERSION?	Read device firmware version
NAME	Set/get machine (DNS) name
NAME-RST	Reset machine name to factory default (DNS)

#

Functions		Permission	Transparency
Set:	#	End User	Public
Get:	-	-	-
Description		Syntax	
Set:	Protocol handshaking	# <input type="checkbox"/> CR	
Get:	-	-	
Response			
~ <input type="checkbox"/> <input type="checkbox"/> @ <input type="checkbox"/> SP <input type="checkbox"/> OK <input type="checkbox"/> CR <input type="checkbox"/> LF			
Notes			
Validates the Protocol 3000 connection and gets the machine number. Step-in master products use this command to identify the availability of a device.			
K-Config Example			
`#", 0x0D			



**BUILD-DATE**

Functions		Permission	Transparency
Set:	-	-	-
Get:	<b>BUILD-DATE?</b>	End User	Public
Description		Syntax	
Set:	-	-	
Get:	Get device build date	# <b>BUILD-DATE?</b> <code>[CR]</code>	
Response			
~ <code>[nn]</code> @ <b>BUILD-DATE</b> <code>[SP]</code> date <code>[SP]</code> time <code>[CR LF]</code>			
Parameters			
date – Format: YYYY/MM/DD where YYYY = Year, MM = Month, DD = Day time – Format: hh:mm:ss where hh = hours, mm = minutes, ss = seconds			
K-Config Example			
"#BUILD-DATE?", 0x0D			

**FACTORY**

Functions		Permission	Transparency
Set:	<b>FACTORY</b>	End User	Public
Get:	-	-	-
Description		Syntax	
Set:	Reset device to factory default configuration	# <b>FACTORY</b> <code>[CR]</code>	
Get:	-	-	
Response			
~ <code>[nn]</code> @ <b>FACTORY</b> <code>[SP]</code> OK <code>[CR LF]</code>			
Notes			
This command deletes all user data from the device. The deletion can take some time. Your device may require powering off and powering on for the changes to take effect.			
K-Config Example			
"#FACTORY", 0x0D			

**HELP**

Functions		Permission	Transparency
Set:	-	-	-
Get:	<b>HELP</b>	End User	Public
Description		Syntax	
Set:	-	-	
Get:	Get command list or help for specific command	# <b>HELP</b> <code>[CR]</code>	
Response			
Multi-line: ~ <code>[nn]</code> @Device available protocol 3000 commands: <code>[CR LF]</code> command, <code>[SP]</code> command... <code>[CR LF]</code>			
Parameters			
COMMAND_NAME – name of a specific command			
Notes			
To get help for a specific command use: <b>HELP</b> <code>[SP]</code> COMMAND_NAME <code>[CR LF]</code>			
K-Config Example			
"#HELP", 0x0D			

**MODEL**

Functions		Permission	Transparency
Set:	-	-	-
Get:	MODEL?	End User	Public
Description		Syntax	
Set:	-	-	
Get:	Get device model	#MODEL? <b>CR</b>	
Response			
~ <b>nn</b> @MODEL <b>SP</b> model_name <b>CR LF</b>			
Parameters			
model_name – String of up to 19 printable ASCII chars			
Notes			
This command identifies equipment connected to Step-in master products and notifies of identity changes to the connected equipment. The Matrix saves this data in memory to answer REMOTE-INFO requests.			
K-Config Example			
`#MODEL?`, 0x0D			

**PROT-VER**

Functions		Permission	Transparency
Set:	-	-	-
Get:	PROT-VER?	End User	Public
Description		Syntax	
Set:	-	-	
Get:	Get device protocol version	#PROT-VER? <b>CR</b>	
Response			
~ <b>nn</b> @PROT-VER <b>SP</b> 3000:version <b>CR LF</b>			
Parameters			
version - XX.XX where X is a decimal digit			
K-Config Example			
`#PROT-VER?`, 0x0D			

**RESET**

Functions		Permission	Transparency
Set:	RESET	Administrator	Public
Get:	-	-	-
Description		Syntax	
Set:	Reset device	#RESET <b>CR</b>	
Get:	-	-	
Response			
~ <b>nn</b> @RESET <b>SP</b> OK <b>CR LF</b>			
Notes			
To avoid locking the port due to a USB bug in Windows, disconnect USB connections immediately after running this command. If the port was locked, disconnect and reconnect the cable to reopen the port.			
K-Config Example			
`#RESET`, 0x0D			

**SN?**

Functions		Permission	Transparency
Set:	-	-	-
Get:	<b>SN?</b>	End User	Public
Description		Syntax	
Set:	-	-	
Get:	Get device serial number	# <b>SN?</b> <code>[CR]</code>	
Response			
~ <code>[nn]</code> @ <b>SN</b> <code>[SP]</code> serial_number <code>[CR LF]</code>			
Parameters			
serial_number – 11 decimal digits, factory assigned			
Notes			
This device has a 14 digit serial number, only the last 11 digits are displayed.			
K-Config Example			
`#SN?`,0x0D			

**VERSION?**

Functions		Permission	Transparency
Set:	-	-	-
Get:	<b>VERSION?</b>	End User	Public
Description		Syntax	
Set:	-	-	
Get:	Get firmware version number	# <b>VERSION?</b> <code>[CR]</code>	
Response			
~ <code>[nn]</code> @ <b>VERSION</b> <code>[SP]</code> firmware_version <code>[CR LF]</code>			
Parameters			
firmware_version – XX.XX.XXXX where the digit groups are: major.minor.build version			
K-Config Example			
`#VERSION?`,0x0D			

**NAME**

Functions		Permission	Transparency
Set:	<b>NAME</b>	Administrator	Public
Get:	<b>NAME?</b>	End User	Public
Description		Syntax	
Set:	Set machine (DNS) name	# <b>NAME</b> <code>[SP]</code> machine_name <code>[CR]</code>	
Get:	Get machine (DNS) name	# <b>NAME?</b> <code>[CR]</code>	
Response			
Set: ~ <code>[nn]</code> @ <b>NAME</b> <code>[SP]</code> machine_name <code>[CR LF]</code>			
Get: ~ <code>[nn]</code> @ <b>NAME</b> <code>[SP]</code> machine_name <code>[CR LF]</code>			
Parameters			
machine_name – String of up to 14 alpha-numeric characters (can include hyphens but not at the beginning or end)			
Notes			
The machine name is not the same as the model name. The machine name is used to identify a specific machine or a network in use (with DNS feature on).			
K-Config Example			
Set the DNS name of the device to "room-442":			
`#NAME room-442`,0x0D			

**NAME-RST**

Functions		Permission	Transparency
Set:	<b>NAME-RST</b>	Administrator	Public
Get:	-	-	-
Description		Syntax	
Set:	Reset machine (DNS) name to factory default	# <b>NAME-RST</b> <input type="checkbox"/>	
Get:	-	-	
Response			
~ <input type="checkbox"/> @ <b>NAME-RST</b> <input type="checkbox"/> OK <input type="checkbox"/> CR LF			
Notes			
Factory default of machine (DNS) name is "KRAMER_" + 4 last digits of device serial number			
K-Config Example			
Reset the machine name (S/N last digits are 0102): `#NAME-RST KRAMER_0102",0x0D`			

**System Commands**

Command	Description
SIGNAL	Get input signal lock status
AV-SW-TIMEOUT	Set auto switching timeout
X-AV-SW-MODE	Set/get auto-switch mode per output
FEATURE-LIST?	Get feature state according to the feature ID
GLOBAL-POE	Set/get global power over Ethernet.
X-LABEL	Set/get the port label of a video/audio port
LOG-TAIL	Retrieve last lines from log file
X-PORT-SELECT	Select/get ID from selectable ports group
X-PORT-SELECT-LIST?	Get selected id of selectable ports groups of all available groups.
HDCP-STAT?	Get HDCP signal status
HDCP-MOD	Set/get HDCP mode
PORTS-LIST?	Get the port list of this machine
SIGNALS-LIST	Get signal ID list of this machine

**SIGNAL**

Functions		Permission	Transparency
Set:	-	-	-
Get	<b>SIGNAL?</b>	End User	Public
Description		Syntax	
Set:	-	-	
Get:	Get input signal lock status	# <b>SIGNAL?</b> <input type="checkbox"/> inp_id <input type="checkbox"/>	
Response			
~ <input type="checkbox"/> @ <b>SIGNAL</b> <input type="checkbox"/> inp_id,status <input type="checkbox"/> CR LF			
Parameters			
inp_id – input number: 1 (Input) status – signal status according to signal validation: 0 (Off), 1 (On)			
Response Triggers			
After execution, a response is sent to the com port from which the Get was received A response is sent after every change in input signal status from On to Off or from Off to On			
K-Config Example			
Get the input signal lock status of IN 1: `#SIGNAL? 1",0x0D`			

**AV-SW-TIMEOUT**

Functions		Permission	Transparency
Set:	<b>AV-SW-TIMEOUT</b>	End User	Public
Get:	<b>AV-SW-TIMEOUT?</b>	End User	Public
Description		Syntax	
Set:	Set auto switching timeout	#AV-SW-TIMEOUT SP action,time_out CR	
Get:	Get auto switching timeout	#AV-SW-TIMEOUT? SP action CR	
Response			
~nn@AV-SW-TIMEOUT SP action,time_out CR			
Parameters			
action – 0 (video signal lost), 1 (new video signal detected), 4 (disable 5V on video output if no input signal detected), 5 (video cable unplugged), 7 (video signal lost for signal routed as a result of a manual override action)			
time_out – timeout in seconds			
K-Config example			
Set the video signal lost timeout to 5 seconds: "#AV-SW-TIMEOUT 0,5",0x0D			

**X-AV-SW-MODE**

Functions		Permission	Transparency
Set:	<b>X-AV-SW-MODE</b>	End user	Public
Get:	<b>X-AV-SW-MODE?</b>	End user	Public
Description		Syntax	
Set:	Set auto switch mode per output	#X-AV-SW-MODE SP output_signal_id,mode CR	
Get:	Get auto switch mode	#X-AV-SW-MODE? SP output_signal_id CR	
Response			
~nn@X-AV-SW-MODE SP output_signal_id,mode CR LF			
Parameters			
Output_signal_id – see <a href="#">Signal ID Format</a> on page 84			
mode – 0 (manual), 1 (priority), 2 (last connected)			
K-Config Example			
Set auto switch mode for HDMI OUT 1 (last connected): "#X-AV-SW-MODE OUT.HDMI.1.VIDEO.1,2",0x0D			

**FEATURE-LIST**

Functions		Permission	Transparency
Set:	-	-	-
Get:	<b>FEATURE-LIST?</b>	End User	Public
Description		Syntax	
Set:	-	-	
Get:	Get feature state according to the feature ID	#FEATURE-LIST? SP id CR	
Response			
~nn@FEATURE-LIST SP id,enable CR LF			
Parameters			
id – 1 (Maestro), 1 (room controller)			
enable – 0 (disable), 1 (enable)			
Notes			
This command is designed to be used by machines and not by users.			
K-Config Example			
Get the room controller feature state (for the room controller): "#FEATURE-LIST? 1",0x0D			

**GLOBAL-POE**

Functions		Permission	Transparency
Set:	<b>GLOBAL-POE</b>	End User	Public
Get:	<b>GLOBAL-POE?</b>	End User	Public
Description		Syntax	
Set:	Set global power over Ethernet ON/OFF	#GLOBAL-POE[SP]state[CR LF]	
Get:	Get power over Ethernet state	#GLOBAL-POE?[CR LF]	
Response			
Get: ~[nn]@GLOBAL-POE[SP]state[CR LF]			
Parameters			
state – ON/OFF (not case sensitive)			
Notes			
PoE affects VS-88UT HDBT outputs only.			
Example			
#GLOBAL-POE ON ~01@GLOBAL-POE ON #GLOBAL-POE? ~01@GLOBAL-POE ON			
K-Config Example			
Set the power over Ethernet global state to on: `#GLOBAL_POE ON",0x0D			

**X-LABEL**

Functions		Permission	Transparency
Set:	<b>X-LABEL</b>	End User	Public
Get:	<b>X-LABEL?</b>	End User	Public
Description		Syntax	
Set:	Set the port label	#X-LABEL[SP]port_id,label_text[CR LF]	
Get:	Get the port label	#X-LABEL?[SP]port_id[CR LF]	
Response			
~[nn]@X-LABEL[SP]port_id,label_text[CR LF]			
Parameters			
port_id – <direction_type>.<port_type>.<port_index>, see <a href="#">Port ID Format</a> on page 83 for further information. label_text – ASCII characters without space			
Notes			
Labels are used commonly by WEB pages			
Examples			
#X-LABEL OUT.HDMI.5, LG-28D ~01@X-LABEL OUT.HDMI.5, LG-28D			
K-Config Example			
Set the port label (for input 1): `#X-LABEL IN.HDMI.1, DVD",0x0D			

**LOG-TAIL**

Functions		Permission	Transparency
Set:	-	-	-
Get:	<b>LOG-TAIL?</b>	End User	Public
Description		Syntax	
Set:	-	-	
Get:	Get the last “n” lines of message logs	# <b>LOG-TAIL?</b> [SP]line_num[CR LF]	
Response			
Get: ~[nn]@ <b>LOG-TAIL?</b> [CR LF] Line content #1[CR LF] Line content #2[CR LF]etc...			
Parameters			
Line_num – optional, 10 (default)			
Notes			
Used for advanced troubleshooting. Helps find error root causes and gets details not displayed in the error code number.			
Example			
#NAME %66yy ~01@NAME %66yy ERR 003 #LOG-TAIL? 1 2015-09-14 09:13:12:566 ERROR P3K_Common_Cmd Invalid name character %(37) - only alphanumeric and hyphen are allowed			

**X-PORT-SELECT**

Functions		Permission	Transparency
Set:	<b>X-PORT-SELECT</b>	End User	Public
Get:	<b>X-PORT-SELECT?</b>	End User	Public
Description		Syntax	
Set:	Select ID from selectable ports group	# <b>X-PORT-SELECT</b> [SP]group_name,selected_id[CR LF]	
Get:	Get selected ID of selectable ports group	# <b>X-PORT-SELECT?</b> [SP]group_name[CR LF]	
Response			
Get: ~[nn]@ <b>X-PORT-SELECT</b> [SP]group_name,selected_id, [option_id:[port_id,...,port_id],...,option_id:[port_id,...,port_id]][CR LF]			
Parameters			
group_name – These are predefined groups names, related to a specific product. For example, for <b>VS-88UT</b> group names are: IN.AUDIO.1, ..., IN.AUDIO.4, IN.VIDEO.5,..., IN.VIDEO.8 selected_id – Currently selected option ID. option_id – Each option has an ID. Only one option may be selected at the same time. When a specific option is selected, all related port-id members become selected and all port-id members from other, unselected options, become unselected.			
Notes			
User may query group names using the command: #X-PORT-SELECT-LIST? This command is designed to be used by machines and not by users. This command is used for feature auto-discovery mechanism.			
Example			
#x-port-select? IN.AUDIO.1 ~01@X-PORT-SELECT IN.AUDIO.1,0,[0:[IN.ANALOG_AUDIO.1],1:[IN.MIC.1,IN.MIC.2]] #x-port-select? IN.VIDEO.5 ~01@X-PORT-SELECT IN.VIDEO.5,1,[0:[IN.HDMI.5],1:[IN.HDBT.5]]			

**X-PORT-SELECT-LIST?**

Functions		Permission	Transparency
Set:	-	-	-
Get:	<b>X-PORT-SELECT-LIST?</b>	End User	Public
Description		Syntax	
Get:	Get selected id of selectable ports groups of all available groups.	# <b>X-PORT-SELECT-LIST?</b> <span style="border: 1px solid black; padding: 0 2px;">CR LF</span>	
Response			
Get: ~ <span style="border: 1px solid black; padding: 0 2px;">nn</span> @ <b>X-PORT-SELECT-LIST?</b> <span style="border: 1px solid black; padding: 0 2px;">SP</span> [[ group_name,selected_id,[option_id:[port_id,...,port_id],...,option_id:[port_id,...,port_id]], ...,[ group_name,selected_id,[option_id:[port_id,...,port_id],...,option_id:[port_id,...,port_id]]] <span style="border: 1px solid black; padding: 0 2px;">CR LF</span>			
Parameters			
Look at – #x-port-select command parameters description.			
Notes			
This command is designed to be used by machines and not by users. This command is used for the auto-discovery mechanism feature. The user may query group names using command: #X-PORT-SELECT-LIST?			
Example			
<pre>#x-port-select-list? ~01@X-PORT-SELECT-LIST [[IN.AUDIO.1,0,[0:[IN.ANALOG_AUDIO.1],1:[IN.MIC.1,IN.MIC.2]]],[IN.AUDIO.2,0,[0:[IN.ANALOG_AUDIO.2],1:[IN.MIC.3,IN.MIC.4]]],[IN.AUDIO.3,0,[0:[IN.ANALOG_AUDIO.3],1:[IN.MIC.5,IN.MIC.6]]],[IN.AUDIO.4,0,[0:[IN.ANALOG_AUDIO.4],1:[IN.MIC.7,IN.MIC.8]]],[IN.VIDEO.5,1,[0:[IN.HDMI.5],1:[IN.HDBT.5]]],[IN.VIDEO.6,0,[0:[IN.HDMI.6],1:[IN.HDBT.6]]],[IN.VIDEO.7,0,[0:[IN.HDMI.7],1:[IN.HDBT.7]]],[IN.VIDEO.8,0,[0:[IN.HDMI.8],1:[IN.HDBT.8]]]]</pre>			

**HDCP-STAT**

Functions		Permission	Transparency
Set:	-	-	-
Get:	<b>HDCP-STAT?</b>	End User	Public
Description		Syntax	
Set:	None	-	
Get:	Get HDCP signal status	# <b>HDCP-STAT?</b> <span style="border: 1px solid black; padding: 0 2px;">SP</span> stage,stage_id <span style="border: 1px solid black; padding: 0 2px;">CR</span>	
Response			
~ <span style="border: 1px solid black; padding: 0 2px;">nn</span> @ <b>HDCP-STAT?</b> <span style="border: 1px solid black; padding: 0 2px;">SP</span> stage,stage_id,status <span style="border: 1px solid black; padding: 0 2px;">CR LF</span>			
Parameters			
stage – 0 (input), 1 (output) stage_id – for input stage: 1 (IN 1), 2 (IN 2), 3 (IN 3), 4 (IN 4), 5 (IN 5), 6 (IN 6), 7 (IN 7), 8 (IN 8), 0 (output disconnected), for output stage 1 (OUT 1), 2 (OUT 2), 3 (OUT 3), 4 (OUT 4), 5 (OUT 5), 6 (OUT 6), 7 (OUT 7), 8 (OUT 8), * (all outputs) status – signal encryption On/Off status: 0 (HDCP Off), 1 (HDCP On), 2 (Follow input), 3 (Mirror output (Mac mode))			
Response Triggers			
Response is sent to the com port from which the Set (before execution) / Get command was received Response is sent to all com ports after execution if <b>HDCP-STAT</b> was set by any other external control device (button press, device menu and similar) or HDCP mode changed.			
Notes			
On output – sink status; On input – signal status. On Video outputs the HDCP-STAT response will tell us if the SINK supports HDCP (and not if the actual signal is HDCP protected) and just in case a signal is sent to the output. In case no Signal is routed to this specific output the status could be inaccurate or missing at all.			
K-Config Example			
Get the output HDCP-STATUS of IN 1: `#HDCP-STAT? 0,1",0x0D`			



**HDCP-MOD**

Functions		Permission	Transparency
Set:	<b>HDCP-MOD</b>	Administrator	Public
Get:	<b>HDCP-MOD?</b>	End User	Public
Description		Syntax	
Set:	Set HDCP mode	# <b>HDCP-MOD</b> [SP]inp_id,mode[CR]	
Get:	Get HDCP mode	# <b>HDCP-MOD?</b> [SP]inp_id[CR]	
Response			
Set/get: ~nn@ <b>HDCP-MOD</b> [SP]inp_id,mode[CR LF]			
Parameters			
inp_id – input number: 1 (IN 1), 2 (IN 2), 3 (IN 3), 4 (IN 4), 5 (IN 5), 6 (IN 6), 7 (IN 7), 8 (IN 8) mode – HDCP mode: 0 (HDCP Off), 1 (HDCP On)			
Response Triggers			
Response is sent to the com port from which the Set (before execution) / Get command was received Response is sent to all com ports after execution if <b>HDCP-MOD</b> was set by any other external control device (button press, device menu and similar) or HDCP mode changed.			
Notes			
Set HDCP working mode on the device input: <ul style="list-style-type: none"> <li>• HDCP supported – HDCP_ON (default)</li> <li>• HDCP not supported – HDCP OFF</li> </ul> HDCP supports changes following a detected sink - MIRROR OUTPUT			
K-Config Example			
Get the input HDCP-MODE of IN 1: "#HDCP-MOD? 1", 0x0D			

**PORTS-LIST**

Functions		Permission	Transparency
Set:	–	–	–
Get:	<b>PORTS-LIST?</b>	End User	Public
Description		Syntax	
Set:	–	–	
Get:	Get the port list of this machine	# <b>PORTS-LIST?</b> [CR LF]	
Response			
~nn@ <b>PORTS-LIST</b> [SP][port_id,...][CR LF]			
Parameters			
port_id – <direction_type>.<port_type>.<port_index>, see <a href="#">Port ID Format</a> on page 83 for further information.			
Notes			
The list includes audio inputs and outputs (analog and mic), video inputs and outputs (HDMI and HDBT), USB, IR and RS-232 ports. This command is designed to be used by machines and not by users. This command is used for the auto-discovery mechanism feature. The response is returned in one line and terminated with [CR LF] The response format lists port IDs separated by commas.			
Examples			
#PORTS-LIST? ~01@PORTS-LIST [IN.HDMI.1, IN.HDMI.2, IN.HDMI.3, IN.HDMI.4, IN.HDMI.5, IN.HDBT.5, IN.HDMI.6, IN.HDBT.6, ..., OUT.HDMI.1, OUT.HDMI.2, ..., IN.ANALOG_AUDIO.1, IN.ANALOG_AUDIO.2, ..., IN.MIC.6, IN.MIC.7, IN.MIC.8, BOTH.RS232.1]			
K-Config Example			
Get the ports list: "#PORTS-LIST?", 0x0D			

**SIGNALS-LIST**

Functions		Permission	Transparency
Set:	–	–	–
Get:	SIGNALS-LIST?	End User	Public
Description		Syntax	
Set:	–	–	
Get:	Get signal ID list of this machine	#SIGNALS-LIST? <input type="text"/>	
Response			
~ <input type="text"/> @SIGNALS-LIST <sub>SF</sub> [ <i>signal_id</i> ,...] <sub>CR LF</sub>			
Parameters			
signal_id – see <a href="#">Signal ID Format</a> on page 84.			
Notes			
<p>The list includes all the optional signals for audio inputs and outputs (analog and mic), video inputs and outputs (HDMI and HDBT), USB, IR and RS-232 ports.</p> <p>This command is designed to be used by machines and not by users. This command is used for the auto-discovery mechanism feature.</p> <p>The response is returned in one line and terminated with <input type="text"/></p> <p>The response format lists signal IDs separated by commas.</p>			
Examples			
<pre>#SIGNALS-LIST? ~01@SIGNALS-LIST [IN.HDMI.1.VIDEO.1, IN.HDMI.2.VIDEO.1, IN.HDMI.3.VIDEO.1, ..., IN.HDBT.5.VIDEO.1, IN.HDBT.6.VIDEO.1, ..., OUT.HDMI.1.VIDEO.1, ..., IN.ANALOG_AUDIO.1.AUDIO.1, ..., IN.MIC.1.AUDIO.1, IN.MIC.2.AUDIO.1, ..., IN.HDMI.1.AUDIO.1, IN.HDMI.2.AUDIO.1, ..., IN.HDBT.6.AUDIO.1, IN.HDBT.7.AUDIO.1, ..., OUT.HDMI.1.AUDIO.1, ..., IN.HDBT.5.RS232.1, IN.HDBT.6.RS232.1, ..., OUT.HDBT.5.RS232.1, OUT.HDBT.6.RS232.1, BOTH.RS232.1.RS232.1, ..., IN.HDBT.5.IR.1, IN.HDBT.6.IR.1, IN.HDBT.7.IR.1, ..., OUT.HDBT.6.IR.1, OUT.IR.5.IR.1, ..., IN.HDBT.5.USB.1, IN.HDBT.6.USB.1, ..., OUT.HDBT.6.USB.1, BOTH.USB_A.1.USB.1, BOTH.USB_A.2.USB.1, BOTH.USB_B.1.USB.1, BOTH.USB_B.2.USB.1]</pre>			
K-Config Example			
<p>Get signal ID list:</p> <pre>"#SIGNALS-LIST?", 0x0D</pre>			

## Authentication Commands

Command	Description
PASS	Set/get password for login level

### PASS

Functions		Permission	Transparency
Set:	<b>PASS</b>	Administrator	Public
Get:	<b>PASS?</b>	Administrator	Public
Description		Syntax	
Set:	Set password for login level	# <b>PASS</b> [SP]login_level,password[CR]	
Get:	Get password for login level	# <b>PASS?</b> [SP]login_level[CR]	
Response			
~nn@ <b>PASS</b> [SP]login_level,password[CR LF]			
Parameters			
login_level – level of login to set: User, Admin			
password – password for the login_level. Up to 15 printable ASCII chars.			
Notes			
The default password is an empty string.			
K-Config Example			
Set the password for the Admin protocol permission level to 33333: `#PASS Admin,33333",0x0D`			

## EDID Handling Commands

Additional EDID data functions can be performed via a compatible EDID management application, such as Kramer EDID Designer (see [www.kramerav.com/product/EDID%20Designer](http://www.kramerav.com/product/EDID%20Designer)).

Command	Description
CPEDID	Copy EDID data from the output to the input EEPROM
EDID-AUDIO	Set/get audio capabilities for EDID
EDID-CS	Set/get EDID color space

### CPEDID

Functions		Permission	Transparency
Set:	CPEDID	End User	Public
Get:	-	-	-
Description		Syntax	
Set:	Copy EDID data from the output to the input EEPROM	#CPEDID[SP]src_type,src_id,dst_type,dest_bitmap[CR]	
Get:	-	-	
Response			
~nn@CPEDID[SP]src_type,src_id,dst_type,dest_bitmap[CR LF]			
Parameters			
src_type – EDID source type (usually output): 0 (Input), 1 (Output), 2 (Default EDID)			
src_id – for input source: 1 (Input), for output source: 0 (Default EDID source), 1 (Output 1), 2 (Output 2)			
dst_type – EDID destination type (usually input): 0 (input)			
dest_bitmap – bitmap representing destination IDs. Format: XXXX...X, where X is hex digit. The binary form of every hex digit represents corresponding destinations. Setting '1' indicates that EDID data is copied to this destination. Setting '0' indicates that EDID data is not copied to this destination.			
Response Triggers			
Response is sent to the com port from which the Set was received (before execution)			
Notes			
Destination bitmap size depends on device properties (for 64 inputs it is a 64-bit word) Example: bitmap 0x0013 means inputs 1, 2 and 5 are loaded with the new EDID. In this device, if the destination type is input (0), the bitmap size is 8 bit, for example bitmap 0x81 means the inputs 1 and 8 are loaded with the new EDID.			
K-Config Example			
Copy the EDID data from the Output 1 (EDID source) to the Input: `#CPEDID 1,1,0,0x1",0x0D`			
Copy the EDID data from the default EDID source to the Input: `#CPEDID 2,0,0,0x1",0x0D`			

**EDID-AUDIO**

Functions		Permission	Transparency
Set:	<b>EDID-AUDIO</b>	End User	Public
Get:	<b>EDID-AUDIO?</b>	End User	Public
Description		Syntax	
Set:	Set audio capabilities for EDID	# <b>EDID-AUDIO</b> <sub>SP</sub> input_id, audio_format <sub>CR</sub>	
Get :	Get audio capabilities for EDID	# <b>EDID-AUDIO?</b> <sub>SP</sub> audio_format <sub>CR</sub>	
Response			
~ <sub>nn</sub> @ <b>EDID-AUDIO</b> <sub>SP</sub> input_id, audio_format <sub>CR LF</sub>			
Parameters			
input_id – see <a href="#">Signal ID Format</a> on page 84			
Audio_format – audio block added to EDID: 0 (auto), 1 (LPCM 2CH), 2 (LPCM 6CH), 3 (LPCM 8CH), 4 (bitstream), 5 (HD)			
K-Config Example			
Set HDMI IN 1 audio capabilities for EDID (LPCM 6CH):			
`#EDID-AUDIO IN.HDMI.1.AUDIO.1,2",0x0D			

**EDID-CS**

Functions		Permission	Transparency
Set:	<b>EDID-CS</b>	End User	Public
Get:	<b>EDID-CS?</b>	End User	Public
Description		Syntax	
Set:	Set EDID color space	# <b>EDID-CS</b> <sub>SP</sub> id, ColSpace <sub>CR</sub>	
Get :	Get EDID color space	# <b>EDID-CS?</b> <sub>SP</sub> id <sub>CR</sub>	
Response			
- <sub>nn</sub> @ <b>EDID-CS</b> <sub>SP</sub> id, ColSpace <sub>CR LF</sub>			
Parameters			
input_id – see <a href="#">Signal ID Format</a> on page 84			
ColSpace – color space: 0 (RGB), 1 (YCbCr 4:2:2), 2 (YCbCr 4:4:4), 3 (All), 4 (Automatic/original config)			
Notes			
Set command might change the current EDID			
K-Config Example			
Set HDMI IN 3 EDID color space to RGB (enabled):			
`#EDID-CS IN.HDMI.3.AUDIO.1,0",0x0D			

## Switch Commands

Command	Description
DISPLAY?	Read if output is valid

### DISPLAY

Functions		Permission	Transparency
Set:	-	-	-
Get	<b>DISPLAY?</b>	End User	Public
Description		Syntax	
Set:	-	-	
Get:	Get output HPD status	# <b>DISPLAY?</b> [SP]out_id[CR]	
Response			
~[nn]@ <b>DISPLAY</b> [SP]out_id,status[CR LF]			
Parameters			
out_id – 1 (Output 1), 2 (Output 2)			
status – HPD status according to signal validation : 0 (Off), 1 (On), 2 (Sink and EDID is valid)			
Response Triggers			
A response is sent to the com port from which the Get was received, after command execution and: After every change in output HPD status from On to Off (0) After every change in output HPD status from Off to On (1) After every change in output HPD status form Off to On and all parameters (new EDID, etc.) are stable and valid (2)			
K-Config Example			
Get the output HPD status of Output 1: `#DISPLAY? 1",0x0D`			

## Routing Commands

Command	Description
MATRIX-STATUS	Get routing status of all output ports
X-AFV	Set/get output audio follow video mode
X-AUD-LVL-RANGE	Get the range of the machine audio level
X-MUTE	Set/get mute ON/OFF on a specific signal
X-PRIORITY	Set/get auto switching input signals group & priorities per output
X-ROUTE	Set/get routing status to matrix

### MATRIX-STATUS?

Functions		Permission	Transparency
Set:	-	-	-
Get:	<b>MATRIX-STATUS?</b>	End User	Public
Description		Syntax	
Set:	-	-	
Get:	Get routing status of all output ports	# <b>MATRIX-STATUS?</b> [CR LF]	
Response			
Multi-line: ~ <b>[nn]</b> @ <b>MATRIX-STATUS</b> <b>[SE]</b> [ [OUT_signal_id,IN_signal_id],... ] <b>[CR LF]</b>			
Parameters			
OUT_signal_id – see <a href="#">Signal ID Format</a> on page 84			
IN_signal_id – see <a href="#">Signal ID Format</a> on page 84			
Notes			
This syntax uses the new convention of using brackets to define a list of fields “[ ]”			
This command is designed to be used by machines and not by users. This command is used for the auto-discovery mechanism feature.			
Example			
<pre>#MATRIX-STATUS? ~01@MATRIX-STATUS [[IN.HDBT.5.RS232.1,OUT.HDBT.5.RS232.1],[IN.HDBT.5.IR.1,IN.IR.5.IR.1],[IN.HDBT.6.RS232.1,OUT.HDBT.6.RS232.1],[IN.HDBT.6.IR.1,IN.IR.6.IR.1],[IN.HDBT.7.RS232.1,BOTH.RS232.1.RS232.1],[IN.HDBT.7.IR.1,IN.IR.7.IR.1],[IN.HDBT.8.IR.1,IN.IR.8.IR.1],[OUT.HDMI.1.VIDEO.1,IN.HDBT.6.VIDEO.1],[OUT.HDMI.1.AUDIO.1,IN.HDBT.6.AUDIO.1],..., [OUT.AMPLIFIED_AUDIO.1.AUDIO.1,IN.ANALOG_AUDIO.2.AUDIO.1],[OUT.HDBT.6.RS232.1,IN.HDBT.6.RS232.1],[OUT.HDBT.6.IR.1,OUT.IR.6.IR.1],[OUT.HDBT.6.USB.1,IN.HDBT.6.USB.1],[BOTH.USB_A.2.USB.1,BOTH.USB_B.2.USB.1],[BOTH.USB_A.1.USB.1,BOTH.USB_B.1.USB.1]]</pre>			
K-Config Example			
Get the room controller current matrix state: `"#MATRIX-STATUS?",0x0D`			

**X-AFV**

Functions		Permission	Transparency
Set:	<b>X-AFV</b>	End User	Public
Get:	<b>X-AFV?</b>	End User	Public
Description		Syntax	
Set:	Set output audio follow video mode	# <b>X-AFV</b> [SP]signal_id,mode[CR LF]	
Get:	Get output audio follow video mode	# <b>X-AFV?</b> [SP]signal_id[CR LF]	
Response			
Get: ~nn@ <b>X-AFV</b> [SP]signal_id,mode[CR LF]			
Parameters			
signal_id – see <a href="#">Signal ID Format</a> on page 84			
mode – OFF/ON, (not case sensitive)			
Example			
#X-AFV OUT.HDMI.1.VIDEO.1,ON ~01@X-AFV OUT.HDMI.1.VIDEO.1,ON			
#X-AFV? OUT.HDMI.1.VIDEO.1 ~01@X-AFV OUT.HDMI.1.VIDEO.1,ON			
K-Config Example			
Set AFV mode for HDMI OUT 5: "#X-AFV OUT.HDMI.5.VIDEO.1,ON",0x0D			

**X-AUD-LVL-RANGE**

Functions		Permission	Transparency
Set:	–	–	–
Get:	<b>X-AUD-LVL-RANGE?</b>	End User	Public
Description		Syntax	
Set:	–	–	–
Get:	Get the range of audio level in the product.	# <b>X-AUD-LVL-RANGE?</b> [SP]analog_output_id[CR LF]	
Response			
Get: ~nn@ <b>X-AUD-LVL-RANGE</b> [SP]analog_output_id, audio_level_range[CR LF]			
Parameters			
analog_output_id – analog output signal ID: see <a href="#">Signal ID Format</a> on page 84			
Example			
#X-AUD-LVL-RANGE? OUT.ANALOG_AUDIO.1.AUDIO.1 ~01@ X-AUD-LVL-RANGE? OUT.ANALOG_AUDIO.1.AUDIO.1, [-83,24]			
K-Config Example			
get the analog output 3 audio level range: "#X-AUD-LVL-RANGE? OUT.ANALOG_AUDIO.3.AUDIO.1",0x0D			



**X-MUTE**

Functions		Permission	Transparency
Set:	<b>X-MUTE</b>	End User	Public
Get:	<b>X-MUTE?</b>	End User	Public
Description		Syntax	
Set:	Set mute ON/OFF on a specific signal.	#X-MUTE[SP]signal_id,state[CR LF]	
Get:	Get mute ON/OFF state on a specific signal.	#X-MUTE?[SP]signal_id[CR LF]	
Response			
Get:	~nn@X-MUTE[SP]signal_id,state[CR LF]		
Parameters			
signal_id – see <a href="#">Signal ID Format</a> on page 84			
state – OFF/ON (not case sensitive)			
Notes			
This command is designed to Mute a Signal. This means that it could be applicable on any type of signal. Could be audio, video and maybe IR, USB or data if this capability is supported by the product.			
Example			
<pre>#x-mute OUT.HDMI.1.VIDEO.1,ON ~01@X-MUTE OUT.HDMI.1.VIDEO.1,ON  #x-mute? OUT.HDMI.1.VIDEO.1 ~01@X-MUTE OUT.HDMI.1.VIDEO.1,ON  #x-mute OUT.ANALOG_AUDIO.1.AUDIO.1,OFF ~01@X-MUTE OUT.ANALOG_AUDIO.1.AUDIO.1,OFF  #x-mute? OUT.ANALOG_AUDIO.1.AUDIO.1 ~01@X-MUTE OUT.ANALOG_AUDIO.1.AUDIO.1,OFF</pre>			
K-Config Example			
Mute the video on HDMI OUT 4:			
`#X-MUTE OUT.HDMI.4.VIDEO.1,ON`,0x0D			

**X-PRIORITY**

Functions		Permission	Transparency
Set:	<b>X-PRIORITY</b>	End User	Public
Get:	<b>X-PRIORITY?</b>	End User	Public
Description		Syntax	
Set:	Set auto switching input signals group & priorities per output	# <b>X-PRIORITY</b> [SP]signal_id, [signal_id, ..., ] [CR LF]	
Get:	Get auto switching input signals group priorities per output	# <b>X-PRIORITY?</b> [SP]signal_id [CR LF]	
Response			
Get:	~[nn]@ <b>X-PRIORITY</b> [SP]master_signal_id, [signal_id, ..., ] [CR LF]		
Parameters			
master_signal_id – see <a href="#">Signal ID Format</a> on page 84			
signal_ids – set the list of input priority: see <a href="#">Signal ID Format</a> on page 84			
Notes			
The order of the inputs in the list is fixing the order to the priority.			
X-PRIORITY is also defining implicitly the video inputs group list for Last-connected auto switching strategy.			
X-PRIORITY override X-MTX-SET-INPUTS configuration.			
Auto switching group list is common for all Auto switching strategies (last connected/ priority)			
This syntax uses the new convention of using brackets to define a list of fields “[ ]”			
Example			
<pre>#X-PRIORITY OUT.HDMI.7.VIDEO.1, [IN.HDMI.1.VIDEO.1, IN.HDMI.2.VIDEO.1, IN.HDMI.3.VIDEO.1] ~01@X-PRIORITY OUT.HDMI.7.VIDEO.1, [IN.HDMI.1.VIDEO.1, IN.HDMI.2.VIDEO.1, IN.HDMI.3.VIDEO.1] #X-PRIORITY? OUT.HDMI.7.VIDEO.1 ~01@X-PRIORITY OUT.HDMI.7.VIDEO.1, [IN.HDMI.1.VIDEO.1, IN.HDMI.2.VIDEO.1, IN.HDMI.3.VIDEO.1]</pre>			
K-Config Example			
Set the input priority for HDMI OUT 3 (in this order – HDMI IN 2 first priority followed by HDMI IN 3 and HDMI IN 1):			
`#X-PRIORITY OUT.HDMI.3.VIDEO.1, [IN.HDMI.2.VIDEO.1, IN.HDMI.3.VIDEO.1, IN.HDMI.1.VIDEO.1]”, 0x0D			

**X-ROUTE**

Functions		Permission	Transparency
Set:	<b>X-ROUTE</b>	End User	Public
Get:	<b>X-ROUTE?</b>	End User	Public
Description		Syntax	
Set:	Send routing command to matrix	#X-ROUTE <sub>SP</sub> OUT_signal_id,IN_signal_id <sub>CR LF</sub>	
Get:	Get routing status	#X-ROUTE? <sub>SP</sub> OUT_signal_id <sub>CR LF</sub>	
Response			
Set / Get: ~nn@X-ROUTE <sub>SP</sub> OUT_signal_id,IN_signal_id <sub>CR LF</sub>			
Parameters			
OUT_signal_id – see <a href="#">Signal ID Format</a> on page 84			
IN_signal_id – see <a href="#">Signal ID Format</a> on page 84			
Notes			
It is recommended to use the command #SIGNALS-LIST? to get the list of all signal IDs available in the system and which can be used in this command			
Video 1 is the default port in this command and is implied even if not written: #X-ROUTE OUT.HDMI.5, IN.HDMI.1 is interpreted as: #X-ROUTE OUT.HDMI.5.VIDEO.1, IN.HDMI.1.VIDEO.1			
Examples			
#X-ROUTE OUT.HDMI.5.VIDEO.1, IN.HDMI.1.VIDEO.1 ~01@X-ROUTE OUT.HDMI.5.VIDEO.1, IN.HDMI.1.VIDEO.1 #X-ROUTE? OUT.HDMI.5.VIDEO.1 ~01@X-ROUTE OUT.HDMI.5.VIDEO.1, IN.HDMI.1.VIDEO.1 Reduced form : #X-ROUTE OUT.HDMI.5, IN.HDMI.1 ~01@X-ROUTE OUT.HDMI.5.VIDEO.1, IN.HDMI.1.VIDEO.1			
K-Config Example			
Route HDMI IN 2 to HDMI OUT 3: "#X-ROUTE OUT.HDMI.3.VIDEO.1, IN.HDMI.2.VIDEO.1", 0x0D			

## Audio Commands

Command	Description
X-MIC-TYPE	set/get microphone type
X-AUD-LVL	Set audio level of a specific signal
X-AUD-ONLY	Set/get audio-only mode

### X-MIC-TYPE

Functions		Permission	Transparency
Set:	<b>X-MIC-TYPE</b>	End User	Public
Get:	<b>X-MIC-TYPE?</b>	End User	Public
Description		Syntax	
Set:	Set microphone type	# <b>X-MIC-TYPE</b> [SP]port_id,mic_type[CR LF]	
Get:	Get microphone type	# <b>X-MIC-TYPE?</b> [SP]port_id[CR LF]	
Response			
Get: ~[nn] <b>@X-PATTERN</b> [SP]signal_id,pattern_id[CR LF]			
Parameters			
port_id – see <a href="#">Signal ID Format</a> on page 84			
mic_type – Dynamic/Condenser (not case sensitive)			
Example			
#x-mic-type IN.MIC.1,DYNAMIC ~01@X-MIC-TYPE IN.MIC.1,DYNAMIC			
#x-mic-type? IN.MIC.1 ~01@X-MIC-TYPE IN.MIC.1,DYNAMIC			
K-Config Example			
Set MIC 3 type to condenser: "#X-MIC-TYPE IN.MIC.3,condenser",0x0D			

### X-AUD-LVL

Functions		Permission	Transparency
Set:	<b>X-AUD-LVL</b>	End User	Public
Get:	<b>X-AUD-LVL?</b>	End User	Public
Description		Syntax	
Set:	Set audio level of a specific signal	# <b>X-AUD-LVL</b> [SP]signal_id,audio_level[CR LF]	
Get:	Get audio level of a specific signal	# <b>X-AUD-LVL?</b> [SP]signal_id[CR LF]	
Response			
Get: ~[nn] <b>@X-AUD-LVL</b> [SP]signal_id,audio_level[CR LF]			
Parameters			
signal_id – see <a href="#">Signal ID Format</a> on page 84			
audio_level – audio level in dB (range between -60 to +30) depending of the ability of the product			
Example			
#X-AUD-LVL OUT.ANALOG_AUDIO.1.AUDIO.1,-10 ~01@X-AUD-LVL OUT.ANALOG_AUDIO.1.AUDIO.1,-10			
#X-AUD-LVL? OUT.ANALOG_AUDIO.1.AUDIO.1 ~01@X-AUD-LVL OUT.ANALOG_AUDIO.1.AUDIO.1,-10.00			
K-Config Example			
Set analog audio output 2 level to +15: "#X-AUD-LVL OUT.ANALOG_AUDIO.2.AUDIO.1,15",0x0D			

**X-AUD-ONLY**

Functions		Permission	Transparency
Set:	<b>X-AUD-ONLY</b>	End User	Public
Get:	<b>X-AUD-ONLY?</b>	End User	Public
Description		Syntax	
Set:	Set audio only mode, where a black pattern is shown and Audio is played over HDMI	# <b>X-AUD-ONLY</b> [SP]signal_id,mode[CR LF]	
Get:	Get audio only mode	# <b>X-AUD-ONLY?</b> [SP]signal_id[CR LF]	
Response			
~[nn]@ <b>X-AUD-ONLY</b> [SP]signal_id,mode[CR LF]			
Parameters			
signal_id – see <a href="#">Signal ID Format</a> on page 84			
mode – OFF/ON (not case sensitive)			
Example			
#X-AUD-ONLY OUT.HDMI.2.VIDEO.1,ON ~01@X-AUD-ONLY OUT.HDMI.2.VIDEO.1,ON			
#X-AUD-ONLY? OUT.HDMI.2.VIDEO.1 ~01@X-AUD-ONLY OUT.HDMI.2.VIDEO.1,ON			
K-Config Example			
Set HDMI OUT 3 to audio only: "#FEATURE LIST OUT.HDMI.3.VIDEO.1,ON",0x0D			

## Video Commands

Command	Description
X-LONG-REACH	Set/get extra range (long reach) for HDBT
X-PATTERN	Set/get pattern on a specific output signal
X-PATTERN-LIST	Get pattern indexes available per signal ID and usable in command X-PATTERN
X-SET-FOLLOWERS	Set/get followers list of a given input signal

### X-LONG-REACH

Functions		Permission	Transparency
Set:	<b>X-LONG-REACH</b>	End User	Public
Get:	<b>X-LONG-REACH?</b>	End User	Public
Description		Syntax	
Set:	Set extra range (long reach) mode for HDBT ports	#X-LONG-REACH[S]port_id,state[CR LF]	
Get:	Get extra range (long reach) state configuration on any port	#X-LONG-REACH?[S]port_id[CR LF]	
Response			
Get:		~nn@X-LONG-REACH[S]port_id,state[CR LF]	
Parameters			
port_id – see <a href="#">Port ID Format</a> on page 83			
state – OFF/ON (not case sensitive)			
Notes			
Some devices support extra range (long reach) mode, used in HDBT applications. Use the command #PORTS-LIST? to list all port IDs available in the system			
Example			
#X-LONG-REACH IN.HDBT.1,OFF ~01@X-LONG-REACH IN.HDBT.1,OFF #X-LONG-REACH? IN.HDBT.1 ~01@X-LONG-REACH IN.HDBT.1,OFF			
K-Config Example			
Set extra range for HDBT IN 7: "#X-LONG-REACH IN.HDBT.7,On",0x0D			

**X-PATTERN**

Functions		Permission	Transparency
Set:	<b>X-PATTERN</b>	End User	Public
Get:	<b>X-PATTERN?</b>	End User	Public
Description		Syntax	
Set:	Set a pattern on a specific output signal.	# <b>X-PATTERN</b> [SP]signal_id,pattern_id[CR LF]	
Get:	Get selected pattern on a specific output signal.	# <b>X-PATTERN?</b> [SP]signal_id[CR LF]	
Response			
Get: ~[nn]@ <b>X-PATTERN</b> [SP]signal_id,pattern_id[CR LF]			
Parameters			
<p>signal_id – see <a href="#">Signal ID Format</a> on page 84</p> <p>pattern_id – 0 (pattern mode is OFF) numbers (pattern numbers according to what the x-patterns-list command returns)</p> <p>Pattern list can be retrieved using the command: #PATTERNS-LIST?</p>			
Notes			
This command is designed to enable patterns (audio and video) on any signal. Pattern numbers vary according to the signal type.			
Example			
<pre>#X-PATTERN OUT.HDMI.1.VIDEO.1,1 ~01@X-PATTERN OUT.HDMI.1.VIDEO.1,1  #X-PATTERN OUT.ANALOG_AUDIO.1.AUDIO.1,1 ~01@X-PATTERN OUT.ANALOG_AUDIO.1.AUDIO.1,1  #X-PATTERN? OUT.ANALOG_AUDIO.1.AUDIO.1 ~01@X-PATTERN OUT.ANALOG_AUDIO.1.AUDIO.1,1</pre>			
K-Config Example			
<p>Set video pattern 3 on HDMI OUT 8 (enabled):</p> <pre>`#X-PATTERN OUT.HDMI.8.VIDEO.1,3",0x0D</pre>			

**X-PATTERNS-LIST?**

Functions		Permission	Transparency
Set:	-	-	-
Get:	<b>X-PATTERNS-LIST?</b>	End User	Public
Description		Syntax	
Set:	-	-	
Get:	Get pattern indexes available per signal ID and usable in the command X-PATTERN	<b>#X-PATTERNS-LIST?</b> [SP]signal_id[CR LF]	
Response			
Get:	~[nn] <b>@X-PATTERNS-LIST</b> [SP]signal_id[CR LF]		
Parameters			
signal_id – see <a href="#">Signal ID Format</a> on page 84			
Notes			
Not all products support patterns for all layers. This list can be usable into X-PATTERN			
Example			
<pre>#X-PATTERNS-LIST? IN.HDMI.1.VIDEO.1 ~01@PATTERNS-LIST IN.HDMI.1.VIDEO.1,[[0:OFF],[1:4 Blue squares],[2:4 B&amp;W squares],[3:Gray color],[4:Vertical lines],[5:Horizontal Lines],[6:White Line with horizontal moving],[7:Colors bars - dark],[8:Colors bars - bright],[9:Gray gradient]]  #X-PATTERNS-LIST? IN.ANALOG_AUDIO.1.AUDIO.1 ~01@PATTERNS-LIST IN.ANALOG_AUDIO.1.AUDIO.1,[[0:OFF],[1:FR100HZ],[2:FR200HZ],[3:FR400HZ],[4:FR1000HZ],[5:FR6000HZ],[6:FR10000HZ],[8:DO],[9:RE],[10:MI],[11:FA],[12:SOL],[13:LA],[14:SI]]</pre>			
K-Config Example			
Get the patterns list: "#PATTERN-LIST?",0x0D			

**X-SET-FOLLOWERS**

Functions		Permission	Transparency
Set:	<b>X-SET-FOLLOWERS</b>	End User	Public
Get:	<b>X-SET-FOLLOWERS?</b>	End User	Public
Description		Syntax	
Set:	Set followers list for a given input signal	<b>#X-SET-FOLLOWERS</b> [SP]input_signal_id,[follower_signal_id,...][CR LF]	
Get:	Get followers list of a given input signal	<b>#X-SET-FOLLOWERS?</b> [SP]signal_id[CR LF]	
Response			
~[nn] <b>@X-SET-FOLLOWERS</b> [SP]signal_id,[signal_id,...][CR LF]			
Parameters			
Input_signal_id – see <a href="#">Signal ID Format</a> on page 84			
follower signal id – see <a href="#">Signal ID Format</a> on page 84			
Notes			
This command is mostly used to define the audio signal for audio-follow-video. This syntax uses the new convention of using brackets to define a list of fields "[ ]"			
Example			
<pre>#X-SET-FOLLOWERS IN.HDMI.2.VIDEO.1, [IN.HDMI.1.AUDIO.1] ~01@X-SET-FOLLOWERS IN.HDMI.2.VIDEO.1, [IN.HDMI.1.AUDIO.1]  #X-SET-FOLLOWERS? IN.HDMI.2.VIDEO.1 ~01@X-SET-FOLLOWERS IN.HDMI.2.VIDEO.1, [IN.HDMI.1.AUDIO.1]</pre>			
K-Config Example			
Set HDMI 1 audio signal and HDBT 7 IR signal to follow HDBT IN 7: "#X-SET-FOLLOWERS IN.HDBT.7.VIDEO.1, [IN.HDMI.1.AUDIO.1, IN.HDBT.7.IR.1]",0x0D			



## Global Mute Command

Command	Description
GLOBAL-MUTE	EMERGENCY mode: mute all the VIDEO/AUDIO outputs

### GLOBAL-MUTE

Functions		Permission	Transparency
Set:	GLOBAL-MUTE	End User	Public
Get:	GLOBAL-MUTE?	End User	Public
Description		Syntax	
Set:	EMERGENCY mode: mute all the VIDEO/AUDIO outputs	#GLOBAL-MUTE SPstate CR LF	
Get:	Get remote mute ON/OFF state	#GLOBAL-MUTE? CR LF	
Response			
Get:	~nn@GLOBAL-MUTE SPstate CR LF		
Parameters			
state – OFF/ON (not case sensitive)			
Notes			
This command is designed to be triggered by the REMOTE MUTE Terminal Block GPIO port localized on the REAR Panel in case of emergency event in which is the customer is interested by muting all Video /Audio outputs. This state is not persistent and is not saved after power cycle. The REMOTE MUTE trigger needs to last at least 0.5 sec in order to trigger a global system mute.			
Example			
<pre>-&gt;Trigger Happen ~01@GLOBAL-MUTE ON  -&gt;Trigger Happen ~01@GLOBAL-MUTE OFF  #GLOBAL-MUTE ON ~01@GLOBAL-MUTE ON  #GLOBAL-MUTE OFF ~01@GLOBAL-MUTE OFF</pre>			
K-Config Example			
<pre>Get Remote Mute state: "#GLOBAL-MUTE?", 0x0D "#GLOBAL-MUTE ON", 0x0D</pre>			

## Communication Commands

Command	Description
ETH-PORT	Set/get Ethernet port protocol
NET-DHCP	Set/get DHCP mode
NET-GATE	Set/get gateway IP
NET-IP	Set/get IP address
NET-MAC	Get MAC address
NET-MASK	Set/get subnet mask
NET-CONFIG	Set/get a network configuration
NET-DNS	Get DNS name server

### ETH-PORT

Functions		Permission	Transparency
Set:	<b>ETH-PORT</b>	Administrator	Public
Get:	<b>ETH-PORT?</b>	End User	Public
Description		Syntax	
Set:	Set Ethernet port protocol	# <b>ETH-PORT</b> [SP]portType, ETHPort[CR]	
Get:	Get Ethernet port protocol	# <b>ETH-PORT?</b> [SP]portType[CR]	
Response			
~[nn]@ <b>ETH-PORT</b> [SP]portType, ETHPort[CR LF]			
Parameters			
portType – 0 (TCP)=, 1 (UDP) ETHPort – 0–65534 (TCP / UDP port number)			
Notes			
If the port number you enter is already in use, an error is returned. The port number must be within the following range: 2000-(2 <sup>16</sup> -1). UDP port 50001 and TCP port 5001 are reserved for internal use.			
K-Config Example			
Set the Ethernet port protocol for TCP to port 12457: `#ETH-PORT 0,12457",0x0D`			

### NET-DHCP

Functions		Permission	Transparency
Set:	<b>NET-DHCP</b>	Administrator	Public
Get:	<b>NET-DHCP?</b>	End User	Public
Description		Syntax	
Set:	Set DHCP mode	# <b>NET-DHCP</b> [SP]mode[CR]	
Get:	Get DHCP mode	# <b>NET-DHCP?</b> [CR]	
Response			
~[nn]@ <b>NET-DHCP</b> [SP]mode[CR LF]			
Parameters			
mode – 0 (do not use DHCP. Use the IP address set by the factory or the <b>NET-IP</b> command), 1 (try to use DHCP. If unavailable, use the IP address set by the factory or the <b>NET-IP</b> command)			
Notes			
Connecting Ethernet to devices with DHCP may take more time in some networks. To connect with a randomly assigned IP by DHCP, specify the device DNS name (if available) using the <b>NAME</b> command. You can also get an assigned IP by direct connection to USB or RS-232 protocol port if available. Consult your network administrator for correct settings.			
K-Config Example			
Enable DHCP mode, if available: `#NET-DHCP 1",0x0D`			

**NET-GATE**

Functions		Permission	Transparency
Set:	<b>NET-GATE</b>	Administrator	Public
Get:	<b>NET-GATE?</b>	End User	Public
Description		Syntax	
Set:	Set gateway IP	# <b>NET-GATE</b> [SP]ip_address[CR]	
Get:	Get gateway IP	# <b>NET-GATE?</b> [CR]	
Response			
~nn@ <b>NET-GATE</b> [SP]ip_address[CR LF]			
Parameters			
ip_address – gateway IP address, in the following format: xxx.xxx.xxx.xxx			
Notes			
A network gateway connects the device via another network, possibly over the Internet. Be careful of security problems. Consult your network administrator for correct settings.			
K-Config Example			
Set the gateway IP address to 192.168.0.1: `#NET-GATE 192.168.000.001",0x0D`			

**NET-IP**

Functions		Permission	Transparency
Set:	<b>NET-IP</b>	Administrator	Public
Get:	<b>NET-IP?</b>	End User	Public
Description		Syntax	
Set:	Set IP address	# <b>NET-IP</b> [SP]ip_address[CR]	
Get:	Get IP address	# <b>NET-IP?</b> [CR]	
Response			
~nn@ <b>NET-IP</b> [SP]ip_address[CR LF]			
Parameters			
ip_address – IP address, in the following format: xxx.xxx.xxx.xxx			
Notes			
Consult your network administrator for correct settings.			
K-Config Example			
Set the IP address to 192.168.1.39: `#NET-IP 192.168.001.039",0x0D`			

**NET-MAC**

Functions		Permission	Transparency
Set:	-	-	-
Get:	<b>NET-MAC?</b>	End User	Public
Description		Syntax	
Set:	-	-	
Get:	Get MAC address	# <b>NET-MAC?</b> [CR]	
Response			
~nn@ <b>NET-MAC</b> [SP]mac_address[CR LF]			
Parameters			
mac_address – unique MAC address. Format: XX-XX-XX-XX-XX-XX where X is hex digit			
K-Config Example			
`#NET-MAC?",0x0D`			

**NET-MASK**

Functions		Permission	Transparency
Set:	<b>NET-MASK</b>	Administrator	Public
Get:	<b>NET-MASK?</b>	End User	Public
Description		Syntax	
Set:	Set subnet mask	# <b>NET-MASK</b> [SP]net_mask[CR]	
Get:	Get subnet mask	# <b>NET-MASK?</b> [CR]	
Response			
~nn@ <b>NET-MASK</b> [SP]net_mask[CR LF]			
Parameters			
net_mask – format: xxx.xxx.xxx.xxx			
Response Triggers			
The subnet mask limits the Ethernet connection within the local network Consult your network administrator for correct settings			
K-Config Example			
Set the subnet mask to 255.255.0.0: `#NET-MASK 255.255.000.000`,0x0D			

**NET-CONFIG**

Functions		Permission	Transparency
Set:	<b>NET-CONFIG</b>	End User	Public
Get:	<b>NET-CONFIG?</b>	End User	Public
Description		Syntax	
Set:	Set a network configuration.	# <b>NET-CONFIG</b> [SP]id,ip,net_mask,gateway[CR LF]	
Get:	Get a network configuration.	# <b>NET-CONFIG?</b> [SP]id[CR LF]	
Response			
Get: ~nn@ <b>NET-CONFIG</b> [SP]id,ip,net_mask,gateway[CR LF]			
Parameters			
id – network ID ip – network IP net_mask – network mask gateway – network gateway			
Example			
# NET-CONFIG 1,192.168.113.10,255.255.0.0,192.168.0.1 ~01@ NET-CONFIG 1,192.168.113.10,255.255.0.0,192.168.0.1			
K-Config Example			
Get network configuration: `#NET-CONFIG?`,0x0D			

**NET-DNS?**

Functions		Permission	Transparency
Set:	–	–	–
Get:	<b>NET-DNS?</b>	End User	Public
Description		Syntax	
Set:	–	–	
Get:	Get DNS name server	#NET-DNS? <b>[SP]</b> dns_id <b>[CR]</b>	
Response			
~nn@NET-DNS <b>[SP]</b> dns_id,ip <b>[CR LF]</b>			
Parameters			
dns_id – ID of the DNS name server to retrieve, indexing starts at “0” Iip – IP address of the DNS server			
Response Triggers			
After execution, response is sent to the com port that sent the Get command			
Notes			
There is no “Set” command. Use NET-CONFIG to setup network, including DNS name servers. If dns_id is out of the defined DNS range, Err=03 is returned. If no dns_id is defined, Err 03 is returned for any dns_id.			
K-Config Example			
Get DNS name server: `#NET-DNS?`,0x0D			

The warranty obligations of Kramer Electronics Inc. ("Kramer Electronics") for this product are limited to the terms set forth below:

#### **What is Covered**

This limited warranty covers defects in materials and workmanship in this product.

#### **What is Not Covered**

This limited warranty does not cover any damage, deterioration or malfunction resulting from any alteration, modification, improper or unreasonable use or maintenance, misuse, abuse, accident, neglect, exposure to excess moisture, fire, improper packing and shipping (such claims must be presented to the carrier), lightning, power surges, or other acts of nature. This limited warranty does not cover any damage, deterioration or malfunction resulting from the installation or removal of this product from any installation, any unauthorized tampering with this product, any repairs attempted by anyone unauthorized by Kramer Electronics to make such repairs, or any other cause which does not relate directly to a defect in materials and/or workmanship of this product. This limited warranty does not cover cartons, equipment enclosures, cables or accessories used in conjunction with this product.

Without limiting any other exclusion herein, Kramer Electronics does not warrant that the product covered hereby, including, without limitation, the technology and/or integrated circuit(s) included in the product, will not become obsolete or that such items are or will remain compatible with any other product or technology with which the product may be used.

#### **How Long this Coverage Lasts**

The standard limited warranty for Kramer products is seven (7) years from the date of original purchase, with the following exceptions:

1. All Kramer VIA products are covered by a standard three (3) year warranty for VIA hardware and a standard one (1) year warranty for firmware and software updates. (An extended software warranty plan for an additional 2 years can be purchased separately).
2. All Kramer fiber optic cables and adapters, active cables, cable retractors, all Kramer speakers and Kramer touch panels are covered by a standard one (1) year warranty.
3. All Kramer Cobra products, all Kramer Calibre products, all Kramer Minicom digital signage products, all HighSecLabs products, all streaming, and all wireless products are covered by a standard three (3) year warranty.
4. All Sierra Video MultiViewers are covered by a standard five (5) year warranty.
5. Sierra switchers & control panels are covered by a standard seven (7) year warranty (excluding power supplies and fans that are covered for three (3) years).
6. K-Touch software is covered by a standard one (1) year warranty for software updates.
7. All Kramer passive cables are covered by a ten (10) year warranty.

#### **Who is Covered**

Only the original purchaser of this product is covered under this limited warranty. This limited warranty is not transferable to subsequent purchasers or owners of this product.

#### **What Kramer Electronics Will Do**

Kramer Electronics will, at its sole option, provide one of the following three remedies to whatever extent it shall deem necessary to satisfy a proper claim under this limited warranty:

1. Elect to repair or facilitate the repair of any defective parts within a reasonable period of time, free of any charge for the necessary parts and labor to complete the repair and restore this product to its proper operating condition. Kramer Electronics will also pay the shipping costs necessary to return this product once the repair is complete.
2. Replace this product with a direct replacement or with a similar product deemed by Kramer Electronics to perform substantially the same function as the original product.
3. Issue a refund of the original purchase price less depreciation to be determined based on the age of the product at the time remedy is sought under this limited warranty.

#### **What Kramer Electronics Will Not Do Under This Limited Warranty**

If this product is returned to Kramer Electronics or the authorized dealer from which it was purchased or any other party authorized to repair Kramer Electronics products, this product must be insured during shipment, with the insurance and shipping charges prepaid by you. If this product is returned uninsured, you assume all risks of loss or damage during shipment. Kramer Electronics will not be responsible for any costs related to the removal or re-installation of this product from or into any installation. Kramer Electronics will not be responsible for any costs related to any setting up this product, any adjustment of user controls or any programming required for a specific installation of this product.

#### **How to Obtain a Remedy Under This Limited Warranty**

To obtain a remedy under this limited warranty, you must contact either the authorized Kramer Electronics reseller from whom you purchased this product or the Kramer Electronics office nearest you. For a list of authorized Kramer Electronics resellers and/or Kramer Electronics authorized service providers, visit our web site at [www.kramerav.com](http://www.kramerav.com) or contact the Kramer Electronics office nearest you.

In order to pursue any remedy under this limited warranty, you must possess an original, dated receipt as proof of purchase from an authorized Kramer Electronics reseller. If this product is returned under this limited warranty, a return authorization number, obtained from Kramer Electronics, will be required (RMA number). You may also be directed to an authorized reseller or a person authorized by Kramer Electronics to repair the product.

If it is decided that this product should be returned directly to Kramer Electronics, this product should be properly packed, preferably in the original carton, for shipping. Cartons not bearing a return authorization number will be refused.

#### **Limitation of Liability**

THE MAXIMUM LIABILITY OF KRAMER ELECTRONICS UNDER THIS LIMITED WARRANTY SHALL NOT EXCEED THE ACTUAL PURCHASE PRICE PAID FOR THE PRODUCT. TO THE MAXIMUM EXTENT PERMITTED BY LAW, KRAMER ELECTRONICS IS NOT RESPONSIBLE FOR DIRECT, SPECIAL, INCIDENTAL OR CONSEQUENTIAL DAMAGES RESULTING FROM ANY BREACH OF WARRANTY OR CONDITION, OR UNDER ANY OTHER LEGAL THEORY. Some countries, districts or states do not allow the exclusion or limitation of relief, special, incidental, consequential or indirect damages, or the limitation of liability to specified amounts, so the above limitations or exclusions may not apply to you.

#### **Exclusive Remedy**

TO THE MAXIMUM EXTENT PERMITTED BY LAW, THIS LIMITED WARRANTY AND THE REMEDIES SET FORTH ABOVE ARE EXCLUSIVE AND IN LIEU OF ALL OTHER WARRANTIES, REMEDIES AND CONDITIONS, WHETHER ORAL OR WRITTEN, EXPRESS OR IMPLIED. TO THE MAXIMUM EXTENT PERMITTED BY LAW, KRAMER ELECTRONICS SPECIFICALLY DISCLAIMS ANY AND ALL IMPLIED WARRANTIES, INCLUDING, WITHOUT LIMITATION, WARRANTIES OF MERCHANTABILITY AND FITNESS FOR A PARTICULAR PURPOSE. IF KRAMER ELECTRONICS CANNOT LAWFULLY DISCLAIM OR EXCLUDE IMPLIED WARRANTIES UNDER APPLICABLE LAW, THEN ALL IMPLIED WARRANTIES COVERING THIS PRODUCT, INCLUDING WARRANTIES OF MERCHANTABILITY AND FITNESS FOR A PARTICULAR PURPOSE, SHALL APPLY TO THIS PRODUCT AS PROVIDED UNDER APPLICABLE LAW. IF ANY PRODUCT TO WHICH THIS LIMITED WARRANTY APPLIES IS A "CONSUMER PRODUCT" UNDER THE MAGNUSON-MOSS WARRANTY ACT (15 U.S.C.A. §2301, ET SEQ.) OR OTHER APPLICABLE LAW, THE FOREGOING DISCLAIMER OF IMPLIED WARRANTIES SHALL NOT APPLY TO YOU, AND ALL IMPLIED WARRANTIES ON THIS PRODUCT, INCLUDING WARRANTIES OF MERCHANTABILITY AND FITNESS FOR THE PARTICULAR PURPOSE, SHALL APPLY AS PROVIDED UNDER APPLICABLE LAW.

#### **Other Conditions**

This limited warranty gives you specific legal rights, and you may have other rights which vary from country to country or state to state.

This limited warranty is void if (i) the label bearing the serial number of this product has been removed or defaced, (ii) the product is not distributed by Kramer Electronics or (iii) this product is not purchased from an authorized Kramer Electronics reseller. If you are unsure whether a reseller is an authorized Kramer Electronics reseller, visit our web site at [www.kramerav.com](http://www.kramerav.com) or contact a Kramer Electronics office from the list at the end of this document.

Your rights under this limited warranty are not diminished if you do not complete and return the product registration form or complete and submit the online product registration form. Kramer Electronics thanks you for purchasing a Kramer Electronics product. We hope it will give you years of satisfaction.



P/N:



2900-300582

Rev:

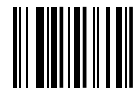

4



## SAFETY WARNING

Disconnect the unit from the power supply before opening and servicing

For the latest information on our products and a list of Kramer distributors, visit our Web site where updates to this user manual may be found.

We welcome your questions, comments, and feedback.