

# OG-FS-Mini

## Frame Synchronizer

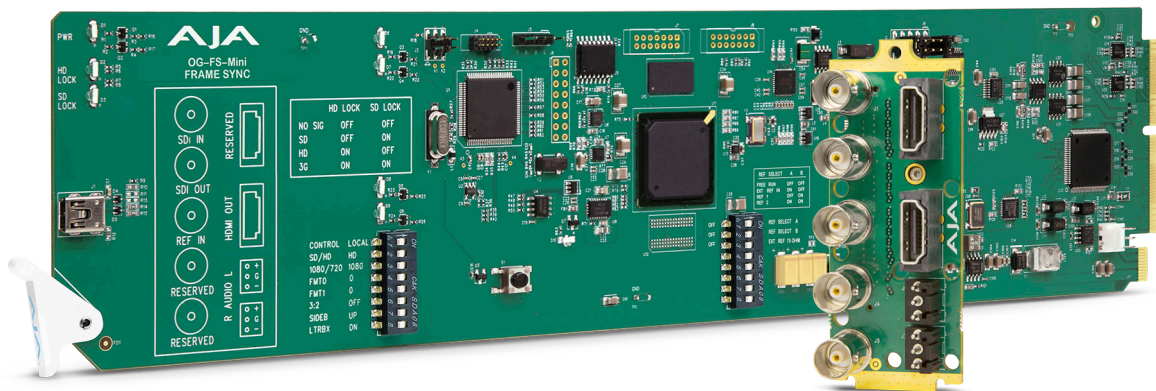

## Installation and Operation Guide

Version 1.0  
Published September 4, 2019



# Notices

---

## Trademarks

---

AJA® and Because it matters.® are registered trademarks of AJA Video Systems, Inc. for use with most AJA products. AJA™ is a trademark of AJA Video Systems, Inc. for use with recorder, router, software and camera products. Because it matters.™ is a trademark of AJA Video Systems, Inc. for use with camera products.

CION®, Corvid Ultra®, Io®, Ki Pro®, KONA®, KUMO®, ROI® and T-Tap® are registered trademarks of AJA Video Systems, Inc.

AJA Control Room™, KiStor™, Science of the Beautiful™, TruScale™, TruZoom™, V2Analog™ and V2Digital™ are trademarks of AJA Video Systems, Inc.

All other trademarks are the property of their respective owners.

## Copyright

---

Copyright © 2019 AJA Video Systems, Inc. All rights reserved. All information in this manual is subject to change without notice. No part of the document may be reproduced or transmitted in any form, or by any means, electronic or mechanical, including photocopying or recording, without the express written permission of AJA Video Systems, Inc.

## Contacting AJA Support

---

When calling for support, have all information at hand prior to calling. To contact AJA for sales or support, use any of the following methods:

Telephone	+1.530.271.3190
FAX	+1.530.271.3140
Web	<a href="https://www.aja.com">https://www.aja.com</a>
Support Email	<a href="mailto:support@aja.com">support@aja.com</a>
Sales Email	<a href="mailto:sales@aja.com">sales@aja.com</a>

# Contents

---

Notices . . . . .	2
Trademarks . . . . .	2
Copyright . . . . .	2
Contacting AJA Support . . . . .	2
<b>Chapter 1 – Introduction . . . . .</b>	<b>4</b>
Overview . . . . .	4
Features . . . . .	4
Video Formats . . . . .	5
Block Diagram . . . . .	5
openGear and AJA . . . . .	5
I/O Connections . . . . .	6
Signal Indicators on the OG-FS-Mini Card . . . . .	6
Signal Indicators in the DashBoard Control System . . . . .	6
Frame Sync Mode Example . . . . .	8
Setup . . . . .	8
Procedure . . . . .	8
Conversion Mode Discussion and Examples . . . . .	8
Upconvert Mode . . . . .	8
Downconvert Mode . . . . .	9
SD Aspect Ratio Convert . . . . .	11
User Controls . . . . .	12
DIP Switches . . . . .	12
DashBoard Control System . . . . .	12
Installation . . . . .	12
Summary . . . . .	12
Unpacking . . . . .	13
Rear OG-FS-Mini Card Installation . . . . .	13
Front OG-FS-Mini Card Installation . . . . .	14
Cabling . . . . .	15
<b>Chapter 2 – Operation . . . . .</b>	<b>16</b>
Default Operational Settings . . . . .	16
Using DIP Switches to Control the OG-FS-Mini . . . . .	16
General Configuration DIP Switches . . . . .	16
Reference Selection DIP Switches . . . . .	18
Using the DashBoard Control System . . . . .	18
Requirements . . . . .	18
Control Interface Basic Components . . . . .	18
Card Tab Screen . . . . .	19
Status Tab Screen . . . . .	20
Video Tab Screen . . . . .	20
HDMI Tab Screen . . . . .	23
Audio Tab Screen . . . . .	24
Setup Tab Screen . . . . .	25
Upload Screen . . . . .	26
Rebooting . . . . .	28
<b>Appendix A – Specifications . . . . .</b>	<b>29</b>
OG-FS-Mini Tech Specs . . . . .	29
<b>Appendix B – Safety and Compliance . . . . .</b>	<b>33</b>
<b>Warranty and Liability Information . . . . .</b>	<b>42</b>
Limited Warranty on Hardware . . . . .	42
Limitation of Liability . . . . .	43
Governing Law and Language; Your Rights . . . . .	43
<b>Index . . . . .</b>	<b>44</b>

# Chapter 1 – Introduction

---

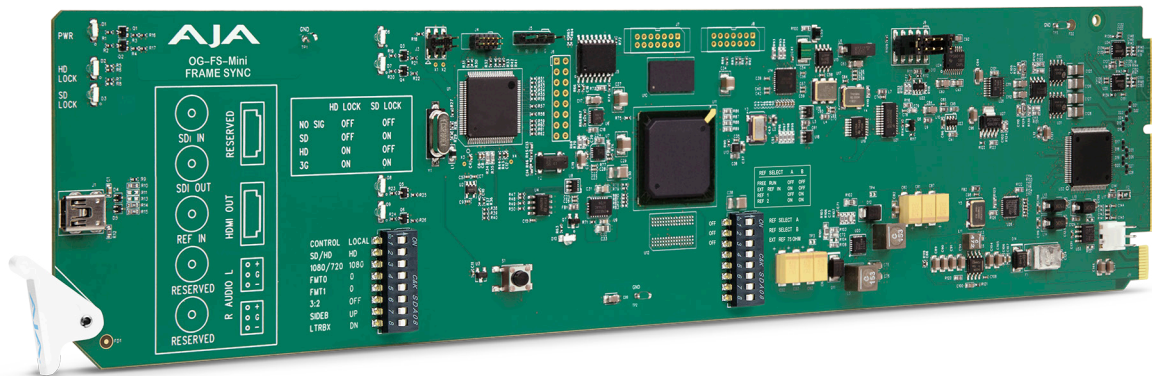

## Overview

---

OG-FS-Mini is an openGear broadcast quality utility frame sync that packs the production-proven functionality and all of the reliability of AJA's leading FS frame sync technology into an OG card supporting frame synchronization of untimed 3G-SDI, HD, and SD video signals at an affordable price.

OG-FS-Mini allows users to synchronize and convert a wide range of video formats to their house standard with a 3G-SDI input and output, HDMI output, and two 3-pin terminal block connectors for balanced analog audio outputs. The OG-FS-Mini also provides high quality up, down, cross-conversion.

Designed for use in high-density openGear's 2RU frames and AJA's OG-X-FR 2RU frame, DashBoard Software support on Windows®, macOS® and Linux offers remote control and monitoring of the openGear architecture and provides convenient and industry-standard configuration, monitoring and control options over a PC or local network.

## Features

---

- openGear compatible card
- Utility frame sync function times input signals to an external reference
- Supports bi-level and tri-level references
- High quality 10-bit video processing
- Low latency processing, nominal video delay of 1 frame
- Freeze (on input signal loss) to black or last good frame
- Supports 1080p, 1080i, 720p, 625i, 525i, and SDI input signals
- Simultaneous SDI and HDMI outputs
- 16-channel embedded SDI audio I/O
- 8-channel HDMI output audio
- 2x 3-Pin terminal block connectors for analog audio output (included)
- Utility frame rate conversion
- Supports 3:2 pulldown
- Up, down, cross conversion between 3G, HD and SD video formats
- AFD input detection, down-convert control

- Remote configuration through DashBoard Control System for an openGear Frame
- Rear I/O card included
- Compatible with OG-X-FR, OG3 and DFR-8321 openGear frames
- Five year warranty

*NOTE: OG-FS-Mini converts 3G-SDI Level A formats only. It does not input or output 3G-SDI Level B.*

## Video Formats

The OG-FS-Mini provides utility frame rate conversion within the same frame rate family as the input frame rate. If a reference is provided, it must be in the same frame rate hierarchy as the input video (e.g., 23.98/29.97/59.94, 25/25, or 24/30/60).

## Block Diagram

*Figure 1. OG-FS-Mini, Simplified Block Diagram*

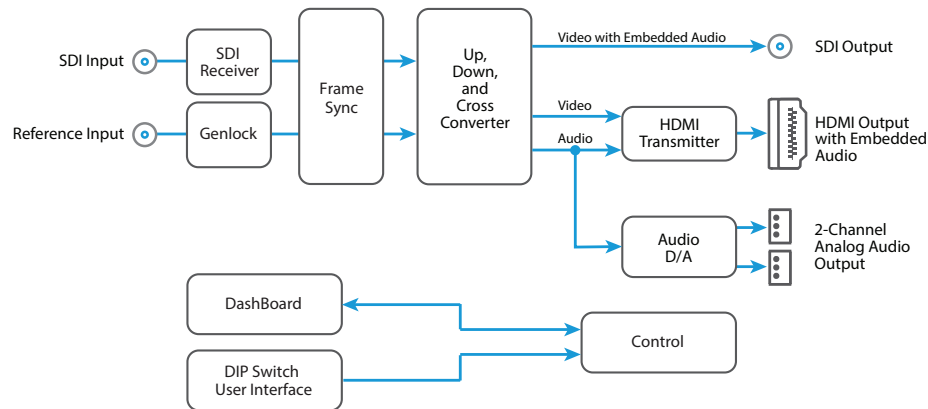

## openGear and AJA

openGear is an open-architecture, modular frame system designed by Ross Video and supported by a diverse range of terminal equipment manufacturers, including AJA. Ross Video manufactures the frames, power supplies and network cards for openGear. AJA is a reseller of the openGear frames.

AJA Video is a leading manufacturer of video interface technologies, converters, digital video recording solutions and professional cameras, bringing high-quality, cost-effective products to the professional, broadcast and post-production markets. AJA products, including openGear cards, are designed and manufactured at our facilities in Grass Valley, California.

# I/O Connections

Figure 2. I/O Connections for the OG-FS-Mini

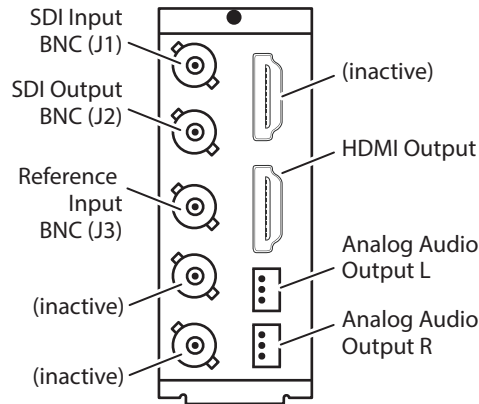

Each 3-pin analog audio connector carries one channel of analog audio output.

## Signal Indicators on the OG-FS-Mini Card

Located at the upper front area of the OG-FS-Mini card, the HD Lock and SD Lock LEDs work in combination to indicate the type of signal detected.

Figure 3. Indicator LEDs and DIP Switch Locations on Card

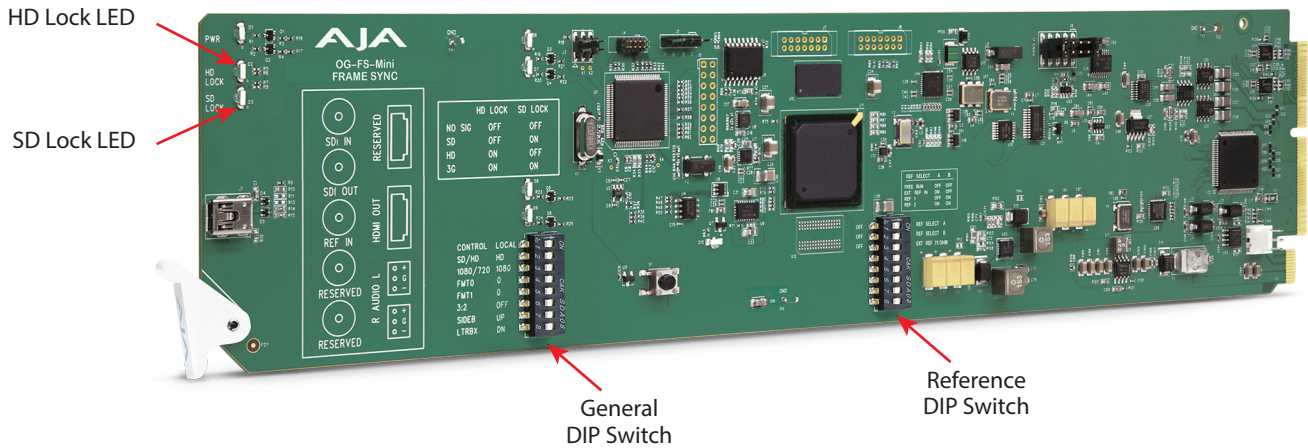

Signal Detected	HD Lock Light	SD Lock Light
No Signal	Off	Off
SD Signal	Off	On
HD Signal	On	Off
3G Signal	On	On

## Signal Indicators in the DashBoard Control System

When the signal is either not present or is not locked, the DashBoard Control System shows both a yellow Card State alarm and a yellow Signal State alarm under the Status tab. Additionally, the SDI Signal Type is shown as "No Signal."

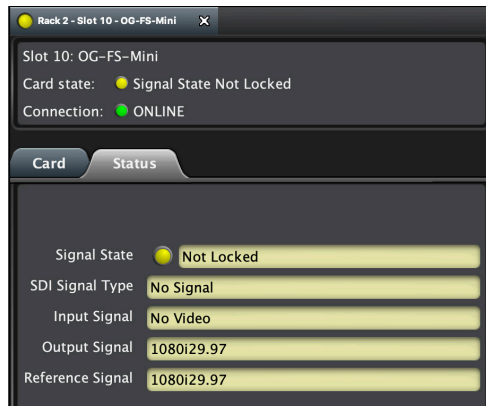

When the **Add 3:2 Pulldown** control has been turned on (indicated by a check mark), and the output frame rates are not the same as the input rates of 23.98 and 24.00, the DashBoard Control System displays a yellow Card State and a yellow Signal State with a "Pulldown Active" alarm warning.

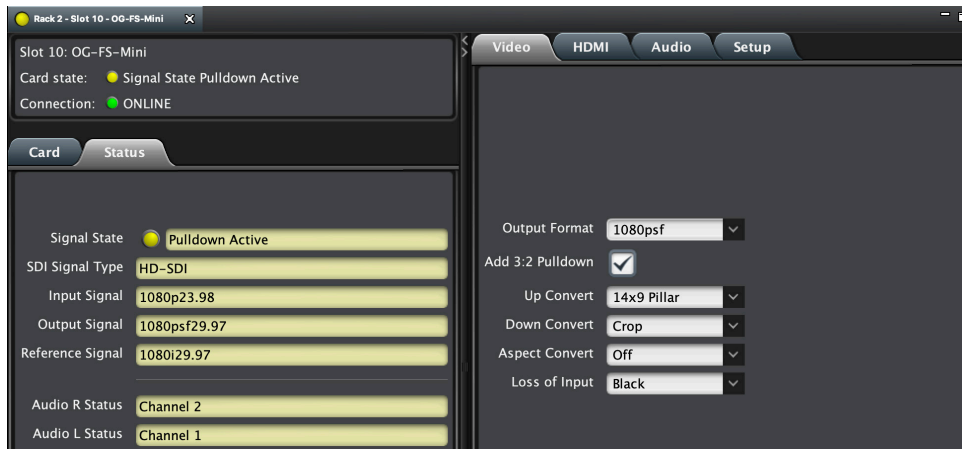

When a signal is present and locked, the DashBoard Control System shows a green Card State and a green Signal State under the Status tab. The SDI Signal Type is also indicated (for example, "3G-SDI").



**NOTE:** Alarms always show the highest priority alarm first. When that alarm condition is resolved, the next alarm/warning condition will display, etc.

# Frame Sync Mode Example

---

The following section provides an example of how to set up the OG-FS-Mini to ensure the frame sync function is working correctly.

## Setup

---

Ensure that the OG-X-FR or other openGear-compatible 2RU frame is powered up and connected to an appropriate network cable to be able to communicate with the DashBoard Control System. (See ["Using the DashBoard Control System" on page 18](#) for details.)

## Procedure

---

1. Install the OG-FS-Mini card and rear connector into the OG-X-FR openGear frame (see ["Installation" on page 12](#) for installation details).
2. Launch the DashBoard application.
3. In the left panel showing the basic tree view of frames and cards, double-click the slot and card name listed corresponding to your OG-FS-Mini.
  - A window opens in DashBoard showing the OG-FS-Mini card and parameter controls.
  - By default the OG-FS-Mini is configured to operate genlocked to an external reference signal.
  - Under the Status tab in DashBoard, the Signal State indicates "Not Locked" with a yellow alarm indicator, and the Reference Signal indicates "No Ref."
4. Connect the appropriate sync reference signal to the OG-FS-Mini Ref In BNC. (See [Figure 2. "I/O Connections for the OG-FS-Mini" on page 6](#) for the location of the Ref In BNC.)
  - The Reference Signal in DashBoard indicates the signal type (for example, 1080i59.94).
  - However, because the OG-FS-Mini is still not receiving a compatible video input, "No Video" will be reported for the Input Signal on DashBoard, and the Signal State is "Not Locked" with a yellow alarm indicator.
5. Connect a 1080p59.94 SDI video source to the OG-FS-Mini SDI In BNC on the BNC rear connector card.
  - DashBoard will report 1080p59.94 for the Input Signal, and the Signal State reports "OK" with a green alarm indicator.
6. From the Video tab, set the Output Format to 1080p (high).
7. Confirm that DashBoard shows that the Output Signal is reporting the correct signal (in this example, 1080p59.94).

This workflow confirms that the OG-FS-Mini powers up successfully and that the SDI video output is synchronized with the Reference Input.

# Conversion Mode Discussion and Examples

---

## Upconvert Mode

---

The OG-FS-Mini allows you to select the type of Upconversion performed on an SD source input. This mode is in effect only when the input is SD (525i or 625i) and the selected output format is HD (720p, 1080i, or 1080p).



Figure 4. Upconvert Mode Examples

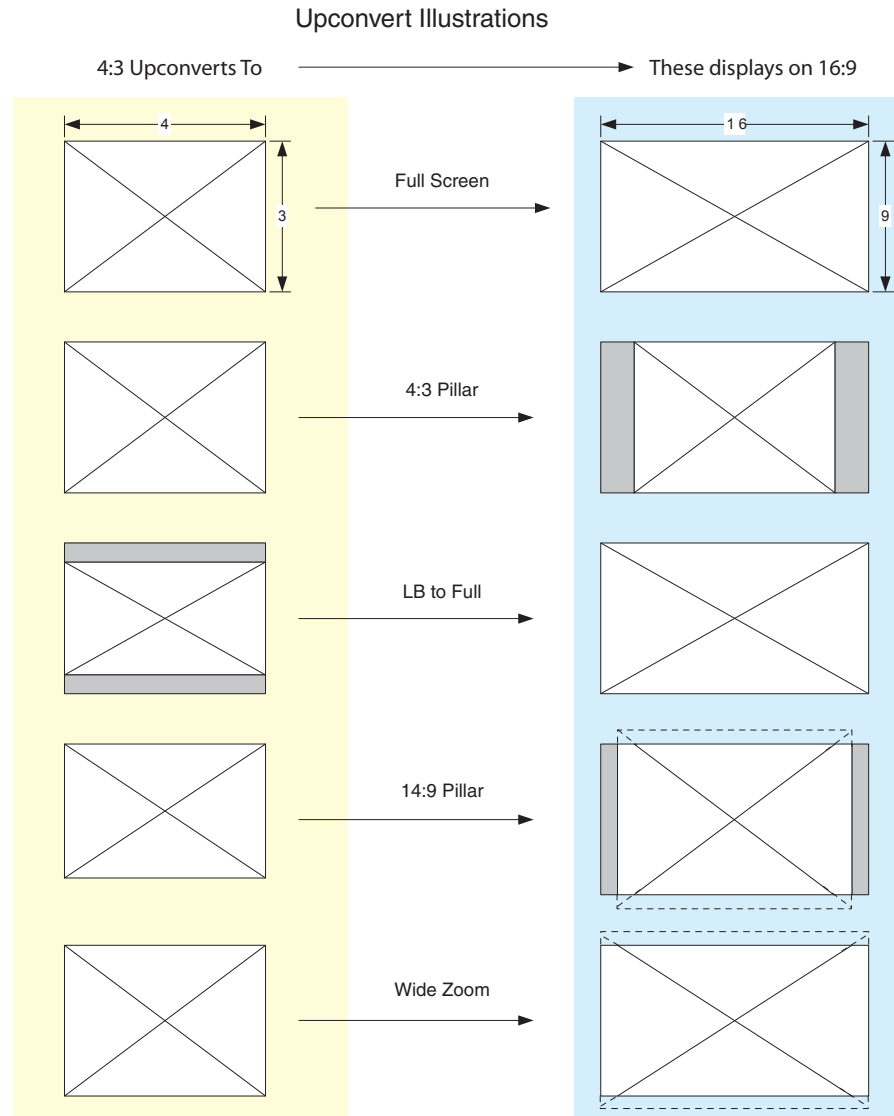

#### Selection Description

- Full Screen – 4x3 image is stretched horizontally to fill a 16x9 frame.
- 4x3 Pillar – 4x3 image at center screen with black sidebars.
- LB to Full – 4x3 letterboxed image is scaled to fit horizontally in a 16x9 frame. Black bars top and bottom are cropped off.
- 14x9 Pillar (default) – 4x3 image is scaled to create a 14x9 image with black sidebars and slightly cropping top and bottom of original image.
- Wide Zoom – A combination of scaling and stretching is used to fit to a 16x9 frame. Slight cropping of top and bottom and a small aspect ratio change.

## Downconvert Mode

This mode determines the type of Downconversion performed on the selected HD source input. See the following Downconvert Illustrations for Downconversion examples. This mode is in effect only when the input is HD (720p, 1080i, or 1080p) and the selected output format is SD (525i or 625i).

Figure 5. Downconvert Mode Example

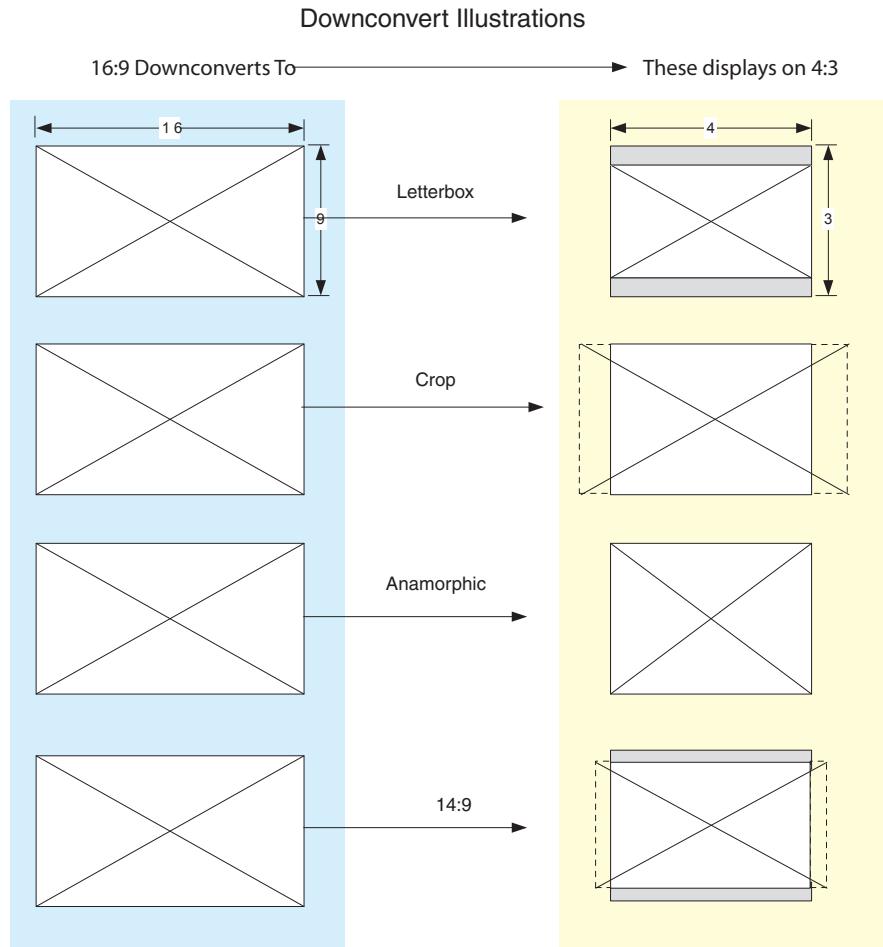

Selection Description

- Letterbox – Image is reduced with black top and bottom added to image area, with the aspect ratio preserved.
- Crop (default) – Image is cropped to fit new screen size.
- Anamorphic – HD image is converted to full-screen SD with a 16x9 aspect ratio (anamorphic).
- 14:9 – Image is reduced slightly with aspect ratio preserved. Black is added top and bottom, and the left and right sides are cropped.
- Auto AFD – Automatically selects the best Downconvert mode based on the input video's Active Format Description (AFD) code.

Active Format Description (AFD) codes are carried in the vertical ancillary (VANC) portion of HD SDI video signals, specified in SMPTE 2016 as follows: "AFD information is intended to guide DTV receivers and/or intermediate professional video equipment regarding the display of video of one aspect ratio on a display of another aspect ratio."

In the OG-FS-Mini Downconverter, the AFD code on the video input can be used to guide the Downconverter in choosing which mode to use to best display the important content of the 16:9 HD input video on the 4:3 SD output. For example, if the input AFD code is 10 (Full Frame), it means that the input video has important picture information throughout the full 16:9 frame, so the Downconverter should use Letterbox mode to be sure none of the content is cropped off. An AFD code of 9 (Pillarbox) says that the input video only has

content within the center 4:3 area of the picture (usually because it originally came from an Upconverted SD signal) so the Downconverter Crop mode would be the best choice. There are 16 possible HD AFD codes, of which 8 are in common use. The OG-FS-Mini does not process or use SD AFD codes.

## SD Aspect Ratio Convert

This mode selects the type of SD-to-SD Aspect Ratio Conversion (ARC) performed on an incoming selected SD source. This mode is in effect only when the input and output are both SD (525i or 625i). (In Europe 16:9 anamorphic video is also known as "wide screen" video.)

Figure 6. SD Aspect Ratio Conversion Examples

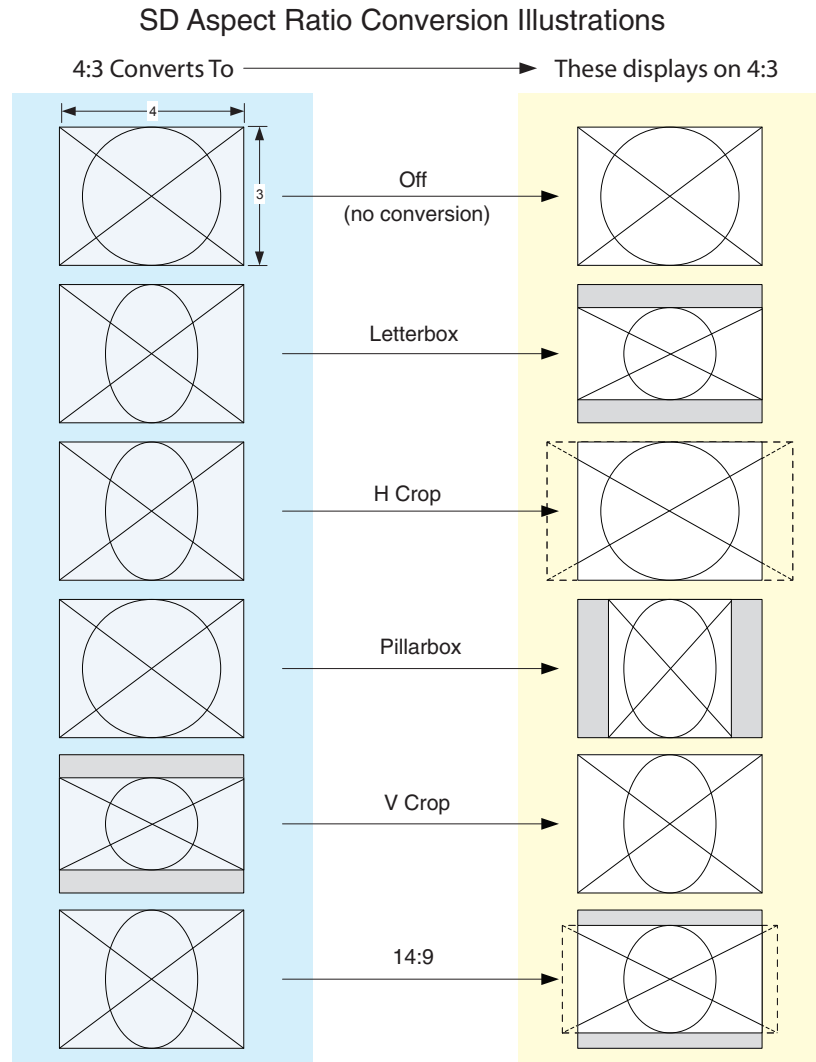

### Selection Descriptions

- **Off**—Turns aspect ratio conversion Off.
- **Letterbox**—Converts 16:9 Anamorphic video to Letterbox video.
- **H Crop**—Converts 16:9 Anamorphic video to 4:3 Standard video (crops left and right edges of video).
- **Pillarbox**—Converts 4:3 Standard video to 16:9 Anamorphic video.
- **V Crop**—Converts Letterbox video to 16:9 Anamorphic video.
- **14:9**—Converts 16:9 Anamorphic video to 14:9 Cropped video.

# User Controls

---

The OG-FS-Mini can be inserted right out of the box into an openGear frame and immediately be used for many applications, since it is designed to recognize inputs and perform standard actions automatically. However, you can also manually configure the OG-FS-Mini using either of two methods:

- Local configuration through DIP switches on the card, or
- Remote configuration through the DashBoard Control System for an openGear Frame.

## DIP Switches

---

The OG-FS-Mini has two DIP switch modules mounted on the card. The left General DIP switch module can be used for general card configuration, and to enable remote configuration using DashBoard. The right Reference DIP switch is used for configuring the card's reference (see [Figure 3 on page 6](#)).

The General DIP switch #1 is a "Local/Remote" switch. When in "Local" mode, the remaining DIP switches support a subset of the user controls, and DashBoard displays only the Card and Status tabs and cannot be used for configuration.

For more details, refer to ["Using DIP Switches to Control the OG-FS-Mini" on page 16](#).

## DashBoard Control System

---

The DashBoard Control System, created by Ross Video, provides a control interface between Windows, macOS and Linux computers and the cards installed in an openGear frame. DashBoard operates through TCP/IP communication and requires an Ethernet connection between the controlling computer and an openGear frame.

For details about acquiring and using the DashBoard Control System, refer to ["Using the DashBoard Control System" on page 18](#).

# Installation

---

## Summary

---

Installing an OG-FS-Mini card into an OG-X-FR openGear frame consists of the following steps:

- Install the Rear Panel onto the back of the frame corresponding to the slot pair you will be using for the OG-FS-Mini card.
- Insert the OG-FS-Mini card into the frame in the right (even numbered) slot of the pair.
- Connect the BNC, HDMI and audio cabling to the Rear Panel.



**ESD Susceptibility** - Static discharge can cause serious damage to sensitive semiconductor devices. Avoid handling circuit boards in high static environments such as carpeted areas, and when wearing synthetic fiber clothing. Always exercise proper grounding precautions when working on circuit boards and related equipment.

## Unpacking

Unpack each openGear product you received from the shipping container and ensure that all items are included. If any items are missing or damaged, contact your sales representative or AJA directly.

## Parts List

Quantity	Description
1	OG-FS-Mini Front Card in ESD bag
1	BNC Rear Card
2	WECO mating connectors, part number 107654-00

## Rear OG-FS-Mini Card Installation

1. Ensure that the frame is properly installed.
2. Locate the card frame slot on the rear of the openGear frame into which you wish to install the openGear card.

*NOTE: An OG-FS-Mini card occupies two slots in the frame.*

3. Using a Phillips screwdriver, unscrew the top screw from the desired blank rear plate and remove the rear plate.
4. Seat the bottom of the Rear Card in the seating slot at the base of the frame back plane.

*Figure 7. Rear Card Inserting Into Frame Seating Slot*

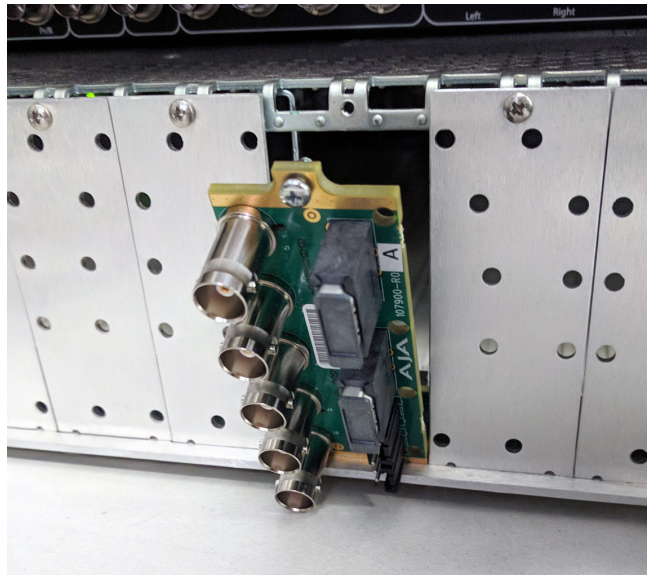

5. Align the top screw of the Rear Card with the screw hole on the top edge of the frame back plane.
6. Ensure the Rear Card aligns with the desired card slot before tightening the screw.
7. Using a Phillips screwdriver, fasten the Rear Card to the frame back plane. Do not over tighten.

Figure 8. Rear Card Inserted Into Frame Seating Slot

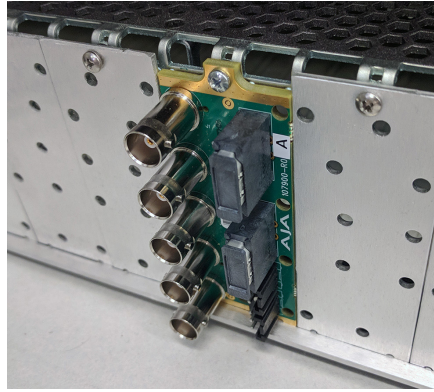

8. Ensure proper frame cooling and ventilation by having all rear frame slots covered with rear modules or blank metal plates if plates are not pre-installed.

## Front OG-FS-Mini Card Installation

1. Open the openGear frame door as follows:
  - A. Gently pull the side door tabs towards the center of the door, releasing the door from the frame.
  - B. Using both hands, pull the door towards you. The door extender arms prevent the door from falling.
2. Locate the Rear Card you installed as described above. The interior slot number is dependent on the slot combinations into which you installed the Rear Card. This allows adequate spacing to avoid damaging the card, the cards installed in the neighboring slots, or both.
3. Hold the card by the edges and carefully align the card edges with the rails inside the frame. The slots are numbered starting from the left-most slot when facing the frame front.

*IMPORTANT: OG-FS-Mini cards are installed into the right (even numbered) slot of the pair in order to connect with the rear panel.*

4. Fully insert the card into the frame until the card is properly seated in the Rear Card.

Figure 9. OG-FS-Mini card inserted Into Right Slot

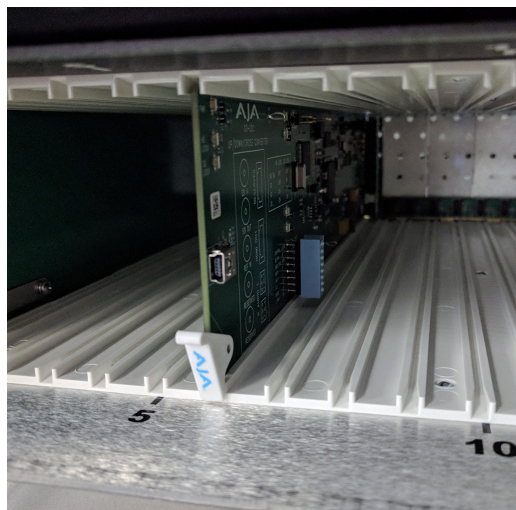

5. Close the frame door as follows:

- A. Slide the door into the frame.
- B. Pull and release the door tabs to ensure the frame door is securely locked to the frame.

## Cabling

---

Refer to "[I/O Connections for the OG-FS-Mini](#)" on [page 6](#) to identify the input and output signal connectors.

Two WECO audio mating connectors are included with each OG-FS-Mini.

1. Insert connecting audio wires into their corresponding holes from the rear ([Figure 10](#)).

*Figure 10. Rear view of the WECO mating audio connector*

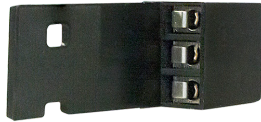

2. Tighten the screws on the other side of the audio mating connector ([Figure 11](#)).

*Figure 11. Front view of the WECO mating audio connector showing the tightening screws*

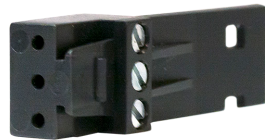

3. After you have secured the wiring for each WECO mating audio connector, connect them to the audio output connectors on the rear panel of the OG-FS-Mini.
4. Add tie wraps around the audio connectors for strain relief.

# Chapter 2 – Operation

---

## Default Operational Settings

---

The OG-FS-Mini converter ships from the factory with the following configuration:

- Local (DIP switch) control (DashBoard shows status only).
- 1080i59.94 output with NTSC related inputs, or 1080i50 output with PAL related inputs.

If these settings apply to your requirements, you can simply connect the video and audio input and output signal cables.

For other applications, you can configure the card using its DIP switch settings, or by setting Remote (DIP switch) control and using the DashBoard Control System and a PC or Mac networked to an openGear frame.

## Using DIP Switches to Control the OG-FS-Mini

---

The OG-FS-Mini has two sets of DIP switches. The first set is used for general configuration. The second set is used only for Reference selection. See [Figure 3 on page 6](#).

### General Configuration DIP Switches

---

The General DIP Switch module is located on the left side of the card.

*Figure 12. General Configuration DIP Switches*

1	CONTROL	LOCAL	REMOTE
2	SD/HD	HD	SD
3	1080/720	1080	720
4	FMT0	0	1
5	FMT1	0	1
6	3:2	OFF	ON
7	SIDE B	UP	FULL
8	LTRBX	DN	FULL

The default DIP switch positions are all in the left position. The default settings result in an output of 1080i59.94 with NTSC related inputs and 1080i50 with PAL related inputs.

For 1080p 23.98/1080PsF 23.98 inputs, the input can be converted to 720p 23.98, 1080p 23.98, 1080i 59.94, or 1080p 59.94. The latter two would use the 3:2 DIP switch to add 3:2 pulldown.

The compliance label, found on the card next to the DIP switches, lists the DIP switch settings.

**NOTE:** *The HDMI output does not support "PsF" formats. When the Video Output Format is configured for PsF, the signal on the HDMI output is converted to interlace. HDMI monitors may not support all frame rates.*



NOTE: OG-FS-Mini converts 3G-A formats only. It does not accept 3G-B input or produce 3G-B output.

## General Configuration DIP Switch Settings

The functions of the general configuration DIP switches and what they control are described in the following tables.

Table 1. General Configuration DIP Switch Setting Descriptions

SWITCH	FUNCTION	DIP Set LEFT (default)	DIP Set RIGHT
1	Control	Selects LOCAL (DIP), and blocks DashBoard configuration control.  When in "Local" mode, the remaining DIP switches will support a subset of the user controls.	Selects REMOTE (DashBoard), and disables DIP switches 2-8.  When in "Remote" mode, the normal DashBoard non-volatile registers (as last set), control the unit.
2	HD/SD	Selects HD output mode.	Selects SD output mode.
3	1080/720 (HD mode only)	Selects 1080 output.	Selects 720 output.
4 & 5	Alternate HD formats	These two DIP switches (FMT0, FMT1) act together to select alternate HD output formats. Zero (0) is Left position, one (1) is Right position.  See <a href="#">Table 2</a> below for setting information.	
6	3:2 Conversion (23.98/24 inputs only)	3:2 conversion is OFF.  A 23.98/24 fps input results in a 23.98/24 fps output.	3:2 conversion is ON.  A 23.98/24 fps input results in either a 29.97/30 or 59.94/60 fps output.
7	Up Conversion	Sets upconversion to Sidebar (SIDEB).	Sets upconversion to Full screen (FULL).
8	Down Conversion	Sets downconversion to Letterbox (LTRBX).	Sets downconversion to Full screen (FULL).

## DIP Switches 4 & 5 (FMT0, FMT1)

General DIP switches 4 and 5 together select alternate HD formats. Switches 1 and 2 can also affect the HD output format. In the table below an X indicates a "Don't Care" setting.

Table 2. Output Formats for DIP Switch 2,3, 4, & 5 Settings

SW2 HD/SD	SW3 1080/720	SW 4 FMT0	SW 5 FMT1	Output
Left	Left	Left	Left	1080i 50/59.94/60
Left	Left	Left	Right	1080PsF 23.98/24/25/29.97/30
Left	Left	Right	Left	1080p 50/59.94/60
Left	Left	Right	Right	1080p 23.98/24/25/29.97/30
Left	Right	X	Left	720p 50/59.94/60
Left	Right	X	Right	-
Right	X	X	X	525i/625i

## Reference Selection DIP Switches

---

The Reference DIP switch module located on the right is used only for Reference selection.

Figure 13. Reference Selection DIP Switches

	REF SELECT	A	B
1	Free Run	Off	Off
2	Card Ext Ref	On	Off
3	OG Frame Ref 1	Off	On
4	OG Frame Ref 2	On	On

## Using the DashBoard Control System

---

The DashBoard Control System is available as a free download from the openGear DashBoard Software Download webpage:

[http://www.opengear.tv/dashboard-software/#support\\_box](http://www.opengear.tv/dashboard-software/#support_box)

Ross Video offers comprehensive documentation that covers the extensive capabilities of the DashBoard Control System:

<https://www.rossvideo.com/support/product-documentation/dashboard/>

This AJA OG-FS-Mini manual addresses only those essential aspects of the DashBoard Control System needed to control the OG-FS-Mini card.

## Requirements

---

The DashBoard Control System requires the following components:

- openGear frame with a Frame Controller card
- Ethernet connection between the controlling computer and the openGear frame

*NOTE: The openGear frame ships from AJA with the MFC-8322-S Frame Controller card for controlling the new AJA DashBoard cards. The openGear frame also supports the MFC-OG3-N Advanced Networking Frame Controller card, which can be used to control compatible OG cards.*

DashBoard automatically discovers openGear and DashBoard Connect devices, such as openGear frames and cards that are present and accessible on your network.

## Control Interface Basic Components

---

The basic components of the DashBoard Control System user interface consist of the basic tree view of frames and cards, the card information and status panel, and the parameter controls panel. These elements are shown below in Figure 6.

The basic tree view of frames and cards shows the frames and cards that are discoverable by DashBoard on your network.

The card information and status panel, shown in the middle panel, display the basic status of the card currently selected in DashBoard.

The parameter controls panel shows the tabs and parameters that the selected card has available for configuration and control.

Figure 14. Main Sections of the Dashboard User Interface

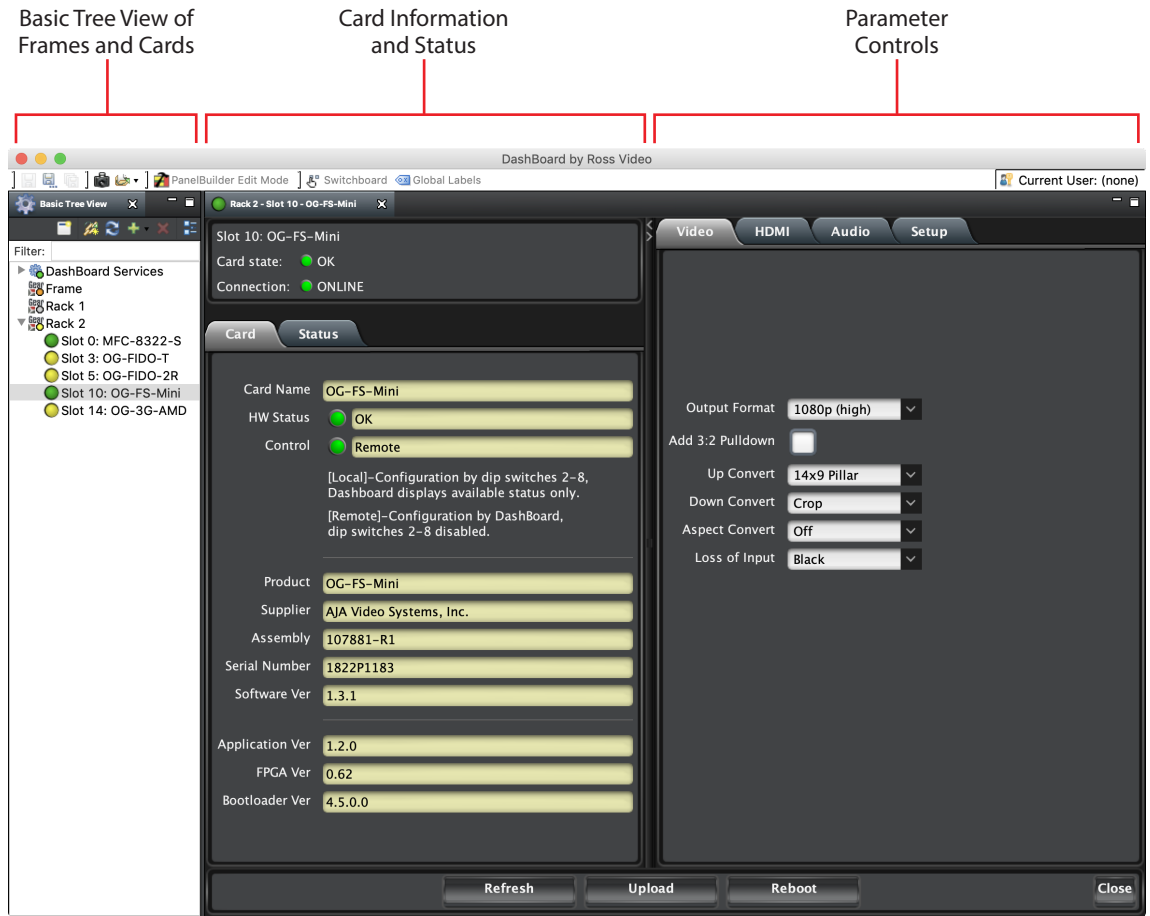

## Card Tab Screen

Figure 15. OG-FS-Mini Card Tab Screen in Dashboard

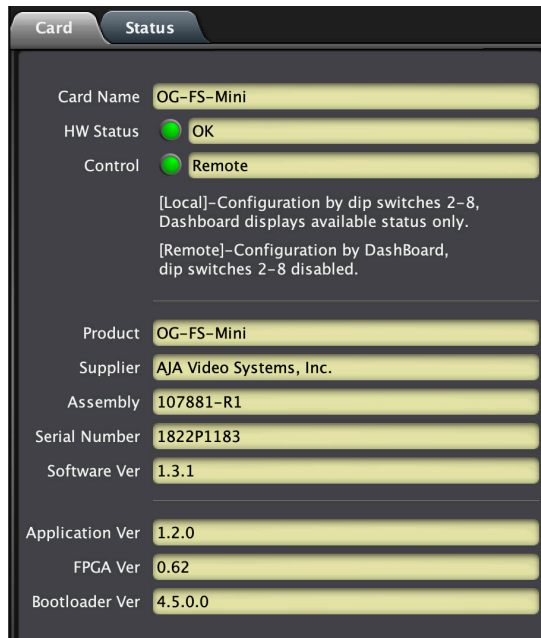

The Card tab screen indicates the basic information about the card itself such as the card name, hardware status, control (local or remote), serial number, software version and other items.

## Status Tab Screen

Figure 16. OG-FS-Mini Status Tab Screen in Dashboard

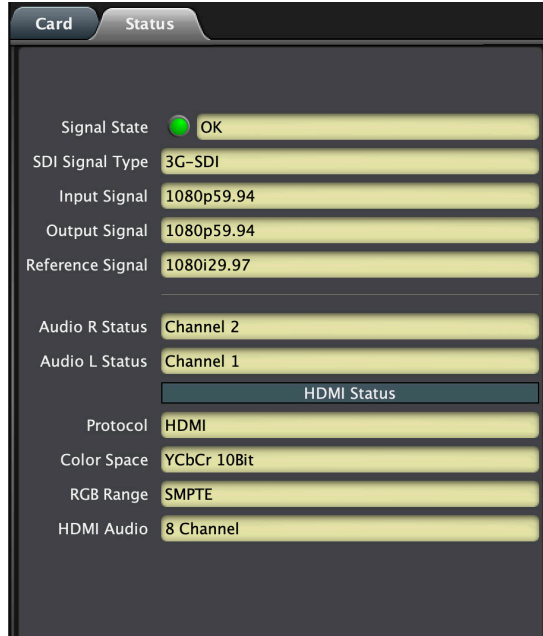

The Status tab screen indicates various signal state alarms, such as OK (green), warning (yellow) or Not Locked (red). Additionally, for configuration parameters that are set to "Auto" from the Video, HDMI and Audio tab screens, the corresponding fields on the Status tab screen report their current setting.

## Video Tab Screen

Figure 17. OG-FS-Mini Video Tab Screen in Dashboard

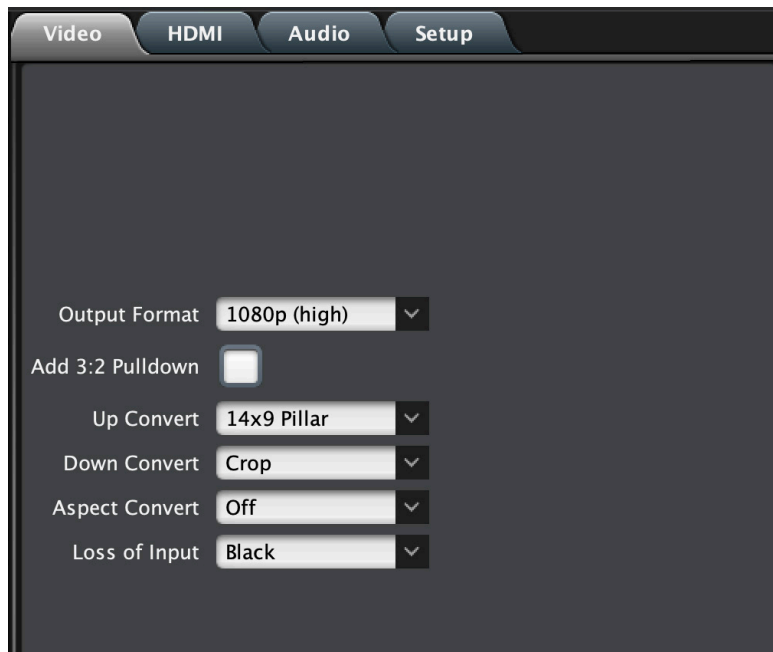

The Video tab screen is where you can configure OG-FS-Mini video inputs and outputs.

### Output Format

---

Determines the OG-FS-Mini output video format. Choose from the following formats:

**SD** - The output video format will be 525i59.94 (for 23.98, 29.97, or 59.94 fps video inputs) or 625i50 (for 25 or 50 fps video inputs).

**720p** - The output video format will be 720p59.94 (for 23.98, 29.97, or 59.94 fps video inputs), 720p60 (for 24, 30, or 60 fps video inputs), or 720p50 (for 25 or 50 fps video inputs).

**1080i** - The output video format will be 1080i59.94 (for 23.98, 29.97, or 59.94 fps video inputs), 1080i60 (for 24, 30, or 60 fps video inputs), or 1080i50 (for 25 or 50 fps video inputs).

**1080psf** - The output video format will be 1080psf23.98 (for 23.98 fps video inputs), 1080psf24 (for 24 fps video inputs), 1080psf25 (for 25 or 50 fps video inputs), 1080psf29.97 (for 29.97 or 59.94 video inputs), or 1080psf30 (for 30 or 60 fps video inputs).

**1080p (low)** - The output video format will be 1080p23.98 (for 23.98 fps video inputs), 1080p24 (for 24 fps video inputs), 1080p25 (for 25 or 50 fps video inputs), 1080p29.97 (for 29.97 or 59.94 video inputs), or 1080p30 (for 30 or 60 fps video inputs).

**1080p (high)** - The output video format will be 1080p50 (for 25 or 50 fps video inputs), 1080p59.94 (for 23.98, 29.97 or 59.94 video inputs), or 1080p60 (for 24, 30 or 60 fps video inputs).

*NOTE: OG-FS-Mini converts 3G-A formats only. It does not input or output 3G-B.*

### Add 3:2 Pulldown

---

When the Add 3:2 Pull down box is checked, 23.98 fps and 24 fps video inputs are converted to 29.97 fps and 30 fps, respectively, by adding 3:2 pull down before conversion. Note that this selection is only used when the OG-FS-Mini module is in Remote mode (DIP switch #1). In Local mode, 3:2 pull down addition is determined by DIP switch #6.

### Up Convert

---

Determines the mode when converting from SD input video to an HD output video format. This selection is only used when the OG-FS-Mini module is in Remote mode (DIP switch #1). In Local mode, the up convert mode is determined by DIP switch #7. Choose from the following:

**4x3 Pillar** - Produces 4x3 image at center screen with black sidebars.

**14x9 Pillar (default)** - Produces 14x9 image, zoomed slightly to fill a 14x9 image with black sidebars.

**Full Screen** - Produces anamorphic full screen display.

**LB to Full Image** - Produces image zoomed to fit the full screen (letterbox).

**Wide Zoom** - Produces an image sized to fit a 16x9 screen using a combination of zoom and stretch. (This can introduce a small aspect ratio change.)

### Down Convert

---

Determines the mode when converting from HD input video to an SD output video format. Note that this selection is only used when the OG-FS-Mini module is in Remote mode (DIP switch #1). In Local mode, the upconvert mode is determined by DIP switch #8. Select from the following:

**Crop (default)** - Image is cropped to fit new screen size.

**Anamorphic** - HD image is converted to full-screen SD with a 16x9 aspect ratio (anamorphic).

**14x9** - Image is reduced slightly with aspect ratio preserved. Black is added top and bottom, and the left and right sides are cropped.

**Auto AFD** - Automatically selects the best Downconvert mode based on the input video's Active Format Description (AFD) code. If the input video is not carrying an AFD VANC code, the Downconverter defaults to crop.

**Letterbox** - Image is reduced with black top and bottom added to image area, with the aspect ratio preserved.

#### Aspect Convert

---

Determines the mode when converting from SD input video to an SD output video format. There is no DIP switch equivalent for this control. The setting is saved in nonvolatile memory in the module and used for all subsequent operation. Choose from the following:

**Off (default)** - The input image is copied to the output with no scaling.

**Letterbox** - The input frame is scaled vertically to a 16x9 "letterboxed" size (anamorphic to letterbox conversion).

**H Crop** - The input frame is scaled horizontally to 16x9, then center-cropped (anamorphic to center crop conversion).

**Pillarbox** - The input frame is scaled horizontally to make a pillarbox output (4x3 to anamorphic conversion).

**V Crop** - The input frame is scaled vertically to make a vertically cropped output (letterbox to anamorphic conversion).

**14x9** - The input frame is scaled horizontally and vertically as a compromise between H Crop and Letterbox (anamorphic to 14x9 conversion).

#### Loss of Input

---

Determines what action is taken when input video is lost. These are the choices:

**Black (default)** - The output goes to black.

**Freeze** - The output freezes on the last good frame.

## HDMI Tab Screen

Figure 18. OG-FS-Mini HDMI Tab Screen in Dashboard

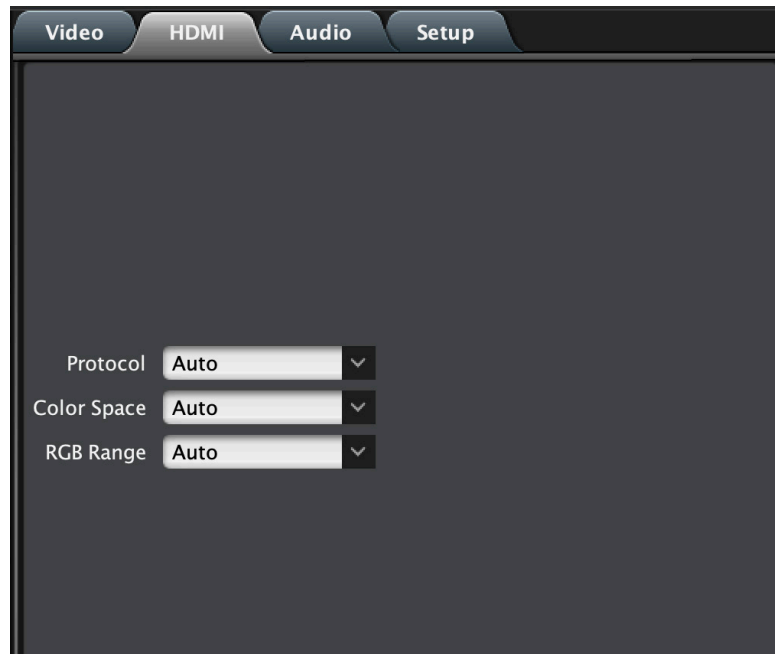

Provides user selection of the HDMI output modes. There is no DIP switch equivalent for these controls. The setting is saved in nonvolatile memory in the module and is used for all subsequent operation.

*NOTE: The HDMI video output always mirrors the SDI video output, both in content and output format selection. Click on the Output tab to view and make changes to the OG-FS-Mini output settings.*

*NOTE: When the output format is set to 1080PsF 23.98 or 1080PsF 24, the HDMI output is converted to interlace because HDMI does not have a corresponding supported format.*

### Protocol

Selects whether the HDMI output uses DVI or HDMI protocols for sending video to the destination device. Select from the following:

**Auto** - OG-FS-Mini automatically selects the output protocol based on getting the attached HDMI device's EDID information. This is the recommended setting.

**HDMI** - OG-FS-Mini uses HDMI protocols regardless of the attached device's EDID.

**DVI** - OG-FS-Mini uses DVI protocols regardless of the attached device's EDID. Because DVI protocols do not support audio or HDMI InfoFrame ancillary data, select this mode only if you know that the attached device requires it.

### Color Space

Selects the HDMI output color space and depth. Choose from the following:

**Auto** - OG-FS-Mini automatically selects the mode based on getting the attached HDMI device's EDID information. This is the recommended setting.

**RGB 8Bit** - OG-FS-Mini uses 8-bit RGB mode regardless of the attached device's EDID.

**RGB 10Bit** - OG-FS-Mini uses 10-bit RGB mode regardless of the attached device's EDID.

**YCbCr 10Bit** - OG-FS-Mini uses 10-bit YCbCr mode regardless of the attached device's EDID.

## RGB Range

Selects the HDMI video levels when the Color Space is RGB 8Bit or RGB 10Bit. Select from the following:

**Auto** - The OG-FS-Mini automatically selects the mode based on getting the attached HDMI device's EDID information. This is the recommended setting.

**SMPTE** - The OG-FS-Mini scales the output video level to 8-bit range 16 - 235 (10-bit 64 - 940) regardless of the attached device's EDID.

**Full Range** - The OG-FS-Mini scales the output video level to 8-bit range 0 - 255 (10-bit 0 - 1023) regardless of the attached device's EDID.

## Audio Tab Screen

Figure 19. OG-FS-Mini Audio Tab Screen in DashBoard

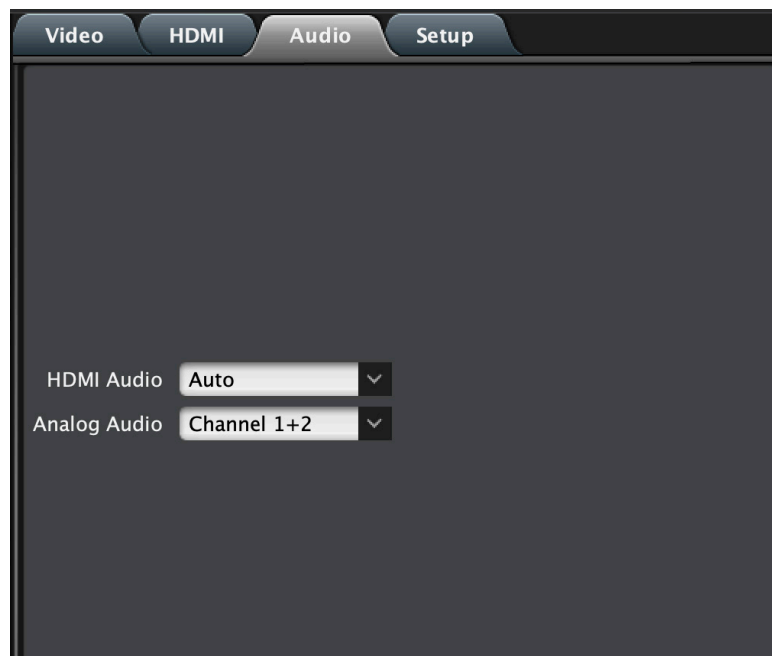

The Audio Tab Screen is where you can configure OG-FS-Mini HDMI and analog (RCA-style) audio output channels. There is no DIP switch equivalent for these controls. The setting is saved in nonvolatile memory in the module and used for all subsequent operation.

*NOTE: The SDI embedded output audio is a channel-for-channel copy of the input SDI embedded audio. There are no user controls.*

## HDMI Audio

Selects how many SDI channels are passed to the HDMI connector and which channel pairs are selected. Select from the following:

**Auto** - The OG-FS-Mini automatically selects the audio output configuration based on communicating with the attached HDMI device.

**2 Channel** - Outputs a pair of channels from the SDI stream to two channels on the HDMI output connector. The selected audio pair is determined by the Analog Audio setting (below).

**8 Channel** - Outputs SDI channels 1 through 8 to the HDMI output connector.



## Analog Audio

Selects the channel pair that will be output to the Analog RCA connectors (L/R) and the HDMI audio output (when HDMI Audio is in 2-channel mode). Choose from the following:

**Channel 1+2**

**Channel 3+4**

**Channel 5+6**

**Channel 7+8**

**Channel 9+10**

**Channel 11+12**

**Channel 13+14**

**Channel 15+16**

## Setup Tab Screen

Click on the Setup tab to view and make changes to the card name, configure the reference source, or to restore card settings to factory default values.

*Figure 20. OG-FS-Mini Setup Tab Screen in DashBoard*

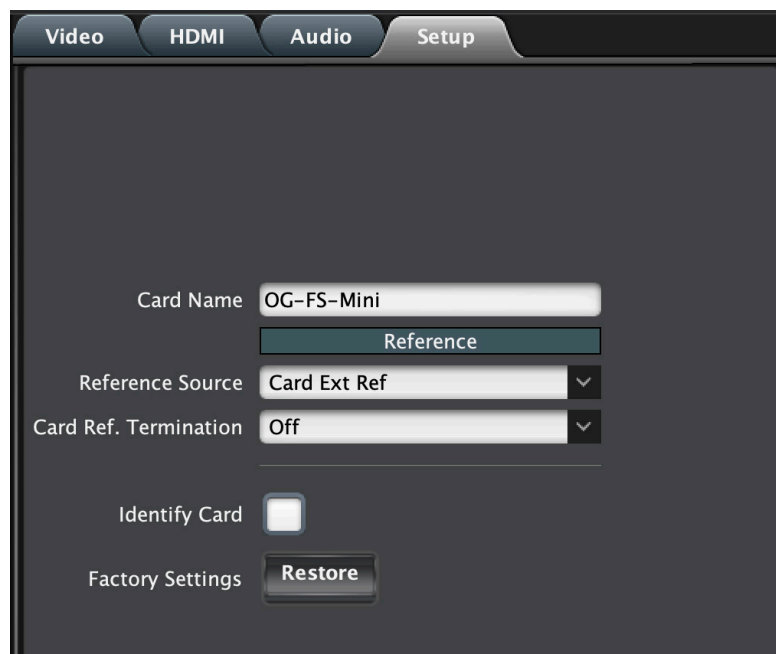

### Card Name

By default, this field is pre-populated with the card name OG-FS-Mini. You can change the card name by editing the text in the Card Name field.

### Reference Source

Select which source you want to use for Reference. Choose from the following:

**Free Run** - The OG-FS-Mini will lock to its internal clock as the reference source.

**Card Ext Ref** - The OG-FS-Mini will use the incoming reference source connected to the Reference Input BNC on the rear panel of the card.

**OG Frame Ref 1** - The OG-FS-Mini will use the incoming reference source connected to the openGear frame's Reference 1 Input BNC on the rear of the frame.

**OG Frame Ref 2** - The OG-FS-Mini will use the incoming reference source connected to the openGear frame's Reference 2 Input BNC on the rear of the frame.

---

### Card Ref Termination

Whether you turn this control On or Off depends on the configuration of your equipment, and whether the incoming reference signal is high impedance or not.

For proper operation the input Reference signal must be stable and properly terminated using a 75-ohm terminator on the last piece of downstream equipment to which the Ref Video is connected.

**On** - Turn on if you have a high impedance incoming reference signal. This will provide signal termination.

**Off** - Turn off (default) if you are not using a high impedance incoming reference signal.

---

### Identify Card

Click the checkbox to turn on Identify Card. This is especially useful when working with numerous cards and frames and you need a simple method for identifying a specific card. Click the checkbox again to turn Identify Card off.

**On** - Turn on if you need to identify the card. When on, the PWR LED located at the front top edge of the card will blink on and off with an orange/green color.

**Off** - Turn off (default) if you do not need to physically identify the card. When Identify Card is off, the PWR LED light illuminates a solid green color when the card is powered on.

---

### Factory Settings

If you would like to revert the card settings to factory default values, click **Restore**. A confirmation window displays.

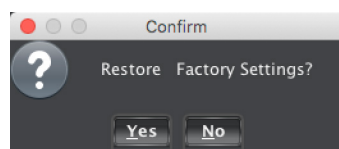

Select **Yes** to restore to factory settings. Select **No** to cancel.

---

## Upload Screen

---

### To Upload New Software

1. Check the AJA website for new software for your OG-FS-Mini. If new software is found, download it and uncompress the file archive (zip).
2. Click the Upload button in the lower panel of the DashBoard Control System to open the Upload Software Wizard.

Figure 21. OG-FS-Mini Upload Software Wizard window in Dashboard

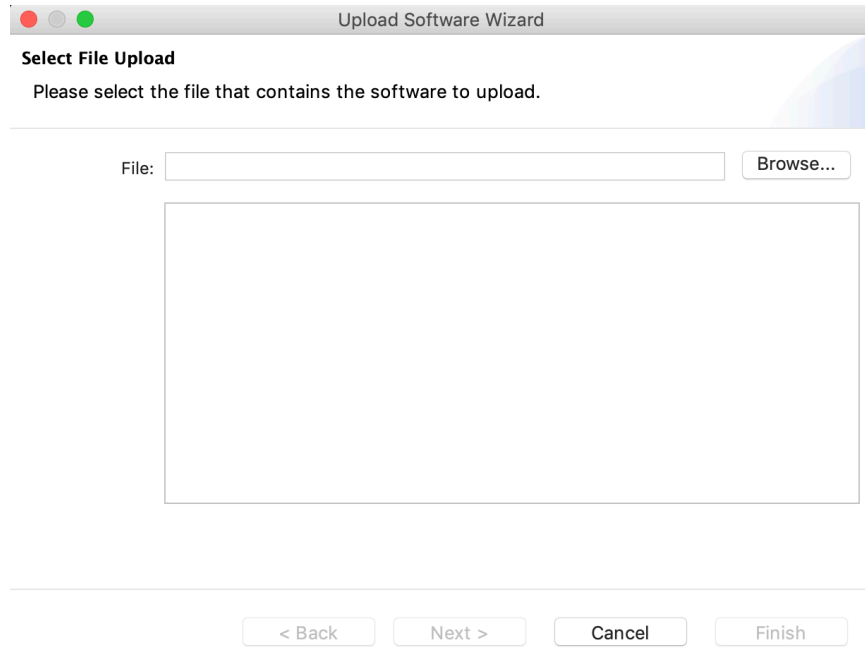

3. From the Upload Software Wizard window, select **Browse**.
4. Navigate to the location of the downloaded .bin file containing the software update. Select the .bin file, then select **Open**. The Upload Software Wizard window displays characteristics of the selected file for uploading.
5. Click **Finish**. The Uploading to Selected Devices window displays with a progress bar.

Figure 22. OG-FS-Mini Uploading to Selected Devices window in Dashboard

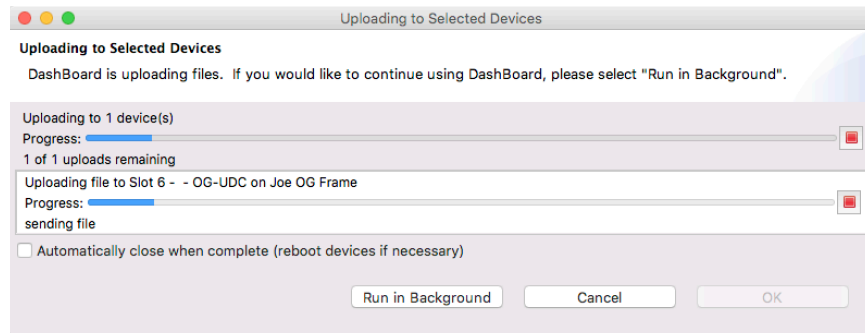

6. When the progress bar indicates that the uploading is finished and status indicates "Complete," click **OK**.
7. To verify the version of software or firmware currently installed on your card, select the Card tab from the center panel of Dashboard.

Figure 23. OG-FS-Mini Card Tab Screen in DashBoard indicating the currently installed software version.

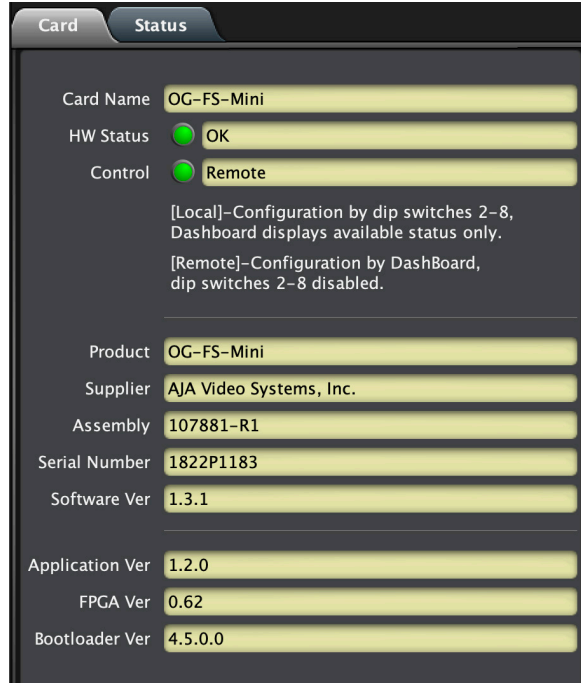

## Rebooting

Rebooting is a standard function built in to the DashBoard Control System, and should only be performed if the board has become unresponsive.

**WARNING:** During a reboot, all output signals are stopped for a few seconds and conversion operations will be briefly interrupted, but will be restored once the reboot has completed.

### To Reboot the OG-FS-Mini

1. Click the Reboot button in the lower panel of DashBoard. The reboot confirmation message displays.

Figure 24. Reboot confirmation window



2. Click **Yes**. The message "Loading data, please wait. Refreshing device data" displays for a moment. The card will be offline for a few seconds, and any current conversion operations will be interrupted.
3. Following a Reboot operation, the board configuration will return to the settings that were in place at the time of rebooting.

# Appendix A – Specifications

---

## OG-FS-Mini Tech Specs

---

Utility frame sync

Aligns and times input video to reference

### Video Formats

---

- (2K) 2048 x 1080p
- (2K) 2048 x 1080PsF
- (HD) 1920 x 1080p
- (HD) 1920 x 1080PsF
- (HD) 1920 x 1080i
- (HD) 1280 x 720p
- (SD) 625i
- (SD) 525i
- YCbCr, 4:2:2, 10-bit

### Video Input Digital

---

- 1x 3G-SDI, 1x BNC
- 3G/HD/SD, SMPTE-259/292/372/424
  - Single Link 3G-SDI Level A, SMPTE-425-1
- (2K) 2048 x 1080p 23.98, 24, 25, 29.97, 30, 50, 59.94, 60
- (2K) 2048 x 1080PsF 23.98, 24, 25, 29.97, 30
- (HD) 1920 x 1080p 23.98, 24, 25, 29.97, 30, 50, 59.94, 60
- (HD) 1920 x 1080PsF 23.98, 24, 25, 29.97, 30
- (HD) 1920 x 1080i 50, 59.94, 60
- (HD) 1280 x 720p 50, 59.94, 60
- (SD) 625i 50
- (SD) 525i 59.94

### Video Output Digital

---

- 1x 3G-SDI outputs, 1x BNC
- 3G/HD/SD, SMPTE-259/292/424
  - Single Link 3G-SDI Level A, SMPTE-425-1
- (HD) 1080p 23.98 (for 23.98 video inputs)
- (HD) 1080p 24 (for 24 video inputs)
- (HD) 1080p 25 (for 50 video inputs)
- (HD) 1080p 29.97 (for 59.94 video inputs)
- (HD) 1080p 30 (for 60 video inputs)
- (HD) 1080p 50 (for 50 video inputs)
- (HD) 1080p 59.94 (for 23.98, 59.94 video inputs)
- (HD) 1080p 60 (for 24, 30 or 60 video inputs)
- (HD) 1080PsF 23.98 (for 23.98 video inputs)
- (HD) 1080PsF 24 (for 24 video inputs)
- (HD) 1080PsF 25 (for 50 video inputs)
- (HD) 1080PsF 29.97 (for 59.94 video inputs)
- (HD) 1080PsF 30 (for 30 or 60 video inputs)

- (HD) 1080i 59.94 (for 23.98, or 59.94 video inputs)
- (HD) 1080i 60 (for 24, 30, or 60 video inputs)
- (HD) 1080i 50 (for 25 or 50 video inputs)
- (HD) 720p 50 (for 50 video inputs)
- (HD) 720p 59.94 (for 23.98, 59.94 video inputs)
- (HD) 720p 60 (for 24, 30, or 60 video inputs)
- (SD) 625i 50 (for 25 or 50 fps video inputs)
- (SD) 525i 59.94 (for 23.98 or 59.94 video inputs)

## Monitor Output Digital

---

- 1x HDMI standard type A connector
  - HD/SD
  - Color space, YCbCr or RGB
  - Bit depth, 8 or 10
  - RGB Range, SMPTE or Full Range

## Video Processing

---

- Frame rate conversion/film cadence removal/insertion (3:2)
- Freeze (on input signal loss) to black or last good frame
- AFD input detection, down-convert control
- Nominal video delay HD/SD, 1 frame

## Up-Conversion

---

- Hardware 10-bit
- 4x3 Pillar: results in a 4x3 image at center screen with black sidebars
- 14x9 Pillar: results in a 4x3 image zoomed slightly to fill a 14x9 image with black side bars
- Full Screen: results in a 4x3 image stretched horizontally to fill in a 16x9 screen
- Letterbox to Full: results in image zoomed to fill fullscreen
- Wide Zoom: results in a combination of zoom and horizontal stretch to fill a 16x9 screen; this setting will introduce a small aspect ratio change

## Down-Conversion

---

- Hardware 10-bit
- Crop: image is cropped to fit new screen size
- Anamorphic: HD image is converted to full-screen SD with a 16x9 aspect ratio
- 14x9: image is reduced slightly with aspect ratio preserved, black is added top and bottom, and the left and right sides are cropped
- Auto AFD: automatically selects the best down-convert mode based on the input video's Active Format Description (AFD) code
- Letterbox: image is reduced with black top and bottom added to image area with the aspect ratio preserved

## Cross-Conversion

---

- Hardware 10-bit
- 1080i to 720p
- 720p to 1080i
- 720p to 1080PsF

## Aspect Ratio Conversion for SD to SD

---

- Letterbox: transforms SD anamorphic material to a letterboxed image
- H Crop: produces a horizontally stretched effect on the image; transforms anamorphic SD to full frame

- SD Pillarbox: produces an image in the center of the screen with black borders on the left and right sides and an anamorphized image in the center
- V Crop: transforms SD letterbox material to an anamorphic image
- 14x9: anamorphic to 14x9 conversion

#### Audio Input Digital

---

- 48 kHz sample rate
- 1x SDI embedded input
  - 16-channels, 24-bit (20-bit SD), SMPTE-272/299

#### Audio Output Digital

---

- 48 kHz sample rate
- 1x SDI embedded output
  - 16-channels, 24-bit (20-bit SD), SMPTE-272/299

#### Audio I/O

---

- 16-channel embedded SDI audio input
- 16-channel embedded SDI audio output
- 8-channel HDMI audio output
- Balanced analog audio outputs, 2x 3-Pin terminal block connectors

#### Reference Input

---

- Supported reference video inputs include:
  - 1080i tri-level sync
  - 1080p tri-level sync
  - 720p tri-level sync
  - 625i Color Black
  - 525i Color Black
- 75-ohm terminating

#### Genlock

---

- Lock to External Reference
- Lock to SDI input
- Free run

#### HDCP

---

- The OG-FS-Mini does not encode the HDMI output with HDCP encryption. By definition, HD-SDI inputs to the OG-FS-Mini are unencrypted. The HDMI specification requires HDMI monitors to support unencrypted inputs.

#### User Interface

---

- External DIP switch
- openGear DashBoard network control software via Windows, macOS or Linux

#### Size

---

- openGear standard form factor, front slot and rear card. Two slots required for each card

#### Weight

---

- 0.5 lb (0.3 kg)

#### Power

---

- openGear frame compatible, 7.0 watts max per card

## Environment

---

- Safe Operating Temperature: 0 to 40 C (32 to 104 F)
- Safe Storage Temperature (Power OFF): -40 to 60 C (-40 to 140 F)
- Operating Relative Humidity: 10-90% noncondensing
- Operating Altitude: <3,000 meters (<10,000 feet)



# Appendix B – Safety and Compliance

---

## Federal Communications Commission (FCC) Compliance Notices

---

### Class A Interference Statement

---

This equipment has been tested and found to comply with the limits for a Class A digital device, pursuant to Part 15, Subpart B of the FCC Rules. These limits are designed to provide reasonable protection against harmful interference in a residential installation. This equipment generates, uses, and can radiate radio frequency energy and, if not installed and used in accordance with the instructions, may cause harmful interference to radio communications. However, there is no guarantee that interference will not occur in a particular installation. If this equipment does cause harmful interference to radio or television reception, which can be determined by turning the equipment off and on, the user is encouraged to try to correct the interference by one or more of the following measures:

- Reorient or relocate the receiving antenna.
- Increase the separation between the equipment and receiver.
- Connect the equipment into an outlet on a circuit different from that to which the receiver is connected.
- Consult the dealer or an experienced radio/TV technician for help.

### FCC Caution

---

This device complies with Part 15 of the FCC Rules. Operation is subject to the following two conditions: (1) This device may not cause harmful interference, and (2) this device must accept any interference received, including interference that may cause undesired operation.

## Canadian ICES Statement

---

### Canadian Department of Communications Radio Interference Regulations

This digital apparatus does not exceed the Class A limits for radio-noise emissions from a digital apparatus as set out in the Radio Interference Regulations of the Canadian Department of Communications. This Class A digital apparatus complies with Canadian ICES-003.

### Règlement sur le brouillage radioélectrique du ministère des Communications

Cet appareil numérique respecte les limites de bruits radioélectriques visant les appareils numériques de classe A prescrites dans le Règlement sur le brouillage radioélectrique du ministère des Communications du Canada. Cet appareil numérique de la Classe A est conforme à la norme NMB-003 du Canada.

## European Union and European Free Trade Association (EFTA) Regulatory Compliance

---

This equipment may be operated in the countries that comprise the member countries of the European Union and the European Free Trade Association. These countries, listed in the following paragraph, are referred to as The European Community throughout this document:

AUSTRIA, BELGIUM, BULGARIA, CYPRUS, CZECH REPUBLIC, DENMARK, ESTONIA, FINLAND, FRANCE, GERMANY, GREECE, HUNGARY, IRELAND, ITALY, LATVIA, LITHUANIA, LUXEMBOURG, MALTA, NETHERLANDS, POLAND, PORTUGAL, ROMANIA, SLOVAKIA, SLOVENIA, SPAIN, SWEDEN, UNITED KINGDOM, ICELAND, LICHTENSTEIN, NORWAY, SWITZERLAND

## Declaration of Conformity

Marking by this symbol indicates compliance with the Essential Requirements of the EMC Directive of the European Union 2014/30/EU.



This equipment meets the following conformance standards:

### Safety

EN 60065: 2014 (T-Mark License),

IEC 60065: 2014 (CB Scheme Report/Certificate)

Additional licenses issued for specific countries available on request.

### Emissions

EN 55032: 2012 + AC: 2013, CISPR 32: 2015,

EN 61000-3-2: 2014, EN 61000-3-3: 2013

### Immunity

EN 55103-2: 2009, EN 61000-4-2:2009, EN 61000-4-3: 2006 + A1:2008 + A2:2010,

EN 61000-4-4: 2004 + A1:2010, EN 61000-4-5:2006, EN 61000-4-6:2009,

EN 61000-4-11:2004

Environments: E2, E3 and E4

The product is also licensed for additional country specific standards as required for the International Marketplace.



**Warning!** This is a Class A product. In a domestic environment, this product may cause radio interference, in which case, the user may be required to take appropriate measures.

**Achtung!** Dieses ist ein Gerät der Funkstörgrenzwertklasse A. In Wohnbereichen können bei Betrieb dieses Gerätes Rundfunkstörungen auftreten, in welchen Fällen der Benutzer für entsprechende Gegenmaßnahmen verantwortlich ist.

**Attention!** Ceci est un produit de Classe A. Dans un environnement domestique, ce produit risque de créer des interférences radioélectriques, il appartiendra alors à l'utilisateur de prendre les mesures spécifiques appropriées..

## Recycling Notice



This symbol on the product or its packaging indicates that this product must not be disposed of with your other household waste. Instead, it is your responsibility to dispose of your waste equipment by handing it over to a designated collection point for the recycling of waste electrical and electronic equipment. The separate collection and recycling of your waste equipment at the time of disposal will help conserve natural resources and ensure that it is recycled in a manner that protects human health and the environment. For more information about where you can drop off your waste for recycling, please contact your local authority, or where you purchased your product.

## Korea KCC Compliance Statement

<p>A급 기기 (업무용 방송통신기자재)</p>	<p>이 기기는 업무용(A급) 전자파적합기기로서 판매자 또는 사용자는 이 점을 주의하시기 바라며, 가정외의 지역에서 사용하는 것을 목적으로 합니다.</p>
<p>Class A (Broadcasting Communication Equipment for Office Use)</p>	<p>As an electromagnetic wave equipment for office use (Class A), this equipment is intended to use in other than home area. Sellers or users need to take note of this.</p>

## Taiwan Compliance Statement

**警告使用者：**  
這是甲類的資訊產品，在居住的環境中使用時，可能會造成射頻干擾，在這種情況下，使用者會被要求採取某些適當的對策。

This is a Class A product based on the standard of the Bureau of Standards, Metrology and Inspection (BSMI) CNS 13438, Class A. In a domestic environment this product may cause radio interference in which case the user may be required to take adequate measures.

## Japan Compliance Statement

この装置は、クラスA情報技術装置です。この装置を家庭環境で使用すると電波妨害を引き起こすことがあります。この場合には使用者が適切な対策を講ずるよう要求されることがあります。 VCCI-A

This is a Class A product based on the standard of the VCCI Council (VCCI 32: 2016). If this equipment is used in a domestic environment, radio interference may occur, in which case, the user may be required to take corrective actions.

## Translated Warning and Caution Messages

The following caution statements, warning conventions, and warning messages apply to this product and manual.



Warning Symbol



Hazard Symbol



Caution Symbol

## Before Operation Please Read These Instructions



**Warning!** Read and follow all warning notices and instructions marked on the product or included in the documentation.

**Avertissement!** Lisez et conformez-vous à tous les avis et instructions d'avertissement indiqués sur le produit ou dans la documentation.

**Warnung!** Lesen und befolgen Sie die Warnhinweise und Anweisungen, die auf dem Produkt angebracht oder in der Dokumentation enthalten sind.

**¡Advertencia!** Lea y siga todas las instrucciones y advertencias marcadas en el producto o incluidas en la documentación.

**Aviso!** Leia e siga todos os avisos e instruções assinalados no produto ou incluídos na documentação.

**Avviso!** Leggere e seguire tutti gli avvisi e le istruzioni presenti sul prodotto o inclusi nella documentazione.



**Warning!** Do not use this device near water and clean only with a dry cloth.

**Avertissement!** N'utilisez pas cet appareil près de l'eau et nettoyez-le seulement avec un tissu sec.

**Warnung!** Das Gerät nicht in der Nähe von Wasser verwenden und nur mit einem trockenen Tuch säubern.

**¡Advertencia!** No utilice este dispositivo cerca del agua y límpielo solamente con un paño seco.

**Aviso!** Não utilize este dispositivo perto da água e limpe-o somente com um pano seco.

**Avviso!** Non utilizzare questo dispositivo vicino all'acqua e pulirlo soltanto con un panno asciutto.



**Warning!** Do not block any ventilation openings. Install in accordance with the manufacturer's instructions.

**Avertissement!** Ne bloquez aucune ouverture de ventilation. Suivez les instructions du fabricant lors de l'installation.

**Warnung!** Die Lüftungsöffnungen dürfen nicht blockiert werden. Nur gemäß den Anweisungen des Herstellers installieren.

**¡Advertencia!** No bloquee ninguna de las aberturas de la ventilación. Instale de acuerdo con las instrucciones del fabricante.

**Aviso!** Não obstrua nenhuma das aberturas de ventilação. Instale de acordo com as instruções do fabricante.

**Avviso!** Non ostruire le aperture di ventilazione. Installare in conformità con le istruzioni del fornitore.



**Warning!** Do not install near any heat sources such as radiators, heat registers, stoves, or other apparatus (including amplifiers) that produce heat.

**Avertissement!** N'installez pas l'appareil près d'une source de chaleur telle que des radiateurs, des bouches d'air de chauffage, des fourneaux ou d'autres appareils (amplificateurs compris) qui produisent de la chaleur.

**Warnung!** Nicht in der Nähe von Wärmequellen wie Heizkörpern, Heizregistern, Öfen oder anderen Wärme erzeugenden Geräten (einschließlich Verstärkern) aufstellen.

**¡Advertencia!** No instale cerca de fuentes de calor tales como radiadores, registros de calor, estufas u otros aparatos (incluidos amplificadores) que generan calor.

**Aviso!** Não instale perto de nenhuma fonte de calor tal como radiadores, saídas de calor, fogões ou outros aparelhos (incluindo amplificadores) que produzam calor.

**Avviso!** Non installare vicino a fonti di calore come termosifoni, diffusori di aria calda, stufe o altri apparecchi (amplificatori compresi) che emettono calore



**Warning!** Do not defeat the safety purpose of the polarized or grounding-type plug. A polarized plug has two blades with one wider than the other. A grounding type plug has two blades and a third grounding prong. The wide blade or the third prong are provided for your safety. If the provided plug does not fit into your outlet, consult an electrician for replacement of the obsolete outlet.

**Avertissement!** La sécurité de la prise polarisée ou de la prise de type mise à la terre ne doit en aucun cas être empêchée de fonctionner. Une prise polarisée a deux broches, l'une étant plus large que l'autre. Une prise de type mise à la terre a deux broches et une troisième broche pour la mise à la terre. La broche large ou la troisième broche sont fournies pour votre sécurité. Si la prise fournie ne s'insère pas dans votre prise femelle, consultez un électricien pour le remplacement de la prise femelle obsolète.

**Warnung!** Der Sicherheitszweck des gepolten bzw. Schukosteckers ist zu berücksichtigen. Ein gepolter Stecker verfügt über zwei Pole, von denen einer breiter als der andere ist. Ein Schukostecker verfügt neben den zwei Polen noch über einen dritten Pol zur Erdung. Der breite Pol bzw. der Erdungspol dienen der Sicherheit. Wenn der zur Verfügung gestellte Stecker nicht in Ihren Anschluss passt, konsultieren Sie einen Elektriker, um den veralteten Anschluss zu ersetzen.

**¡Advertencia!** No eche por tierra la finalidad del tipo de enchufe polarizado con conexión a tierra. Un enchufe polarizado tiene dos espigas, una más ancha que la otra. Un enchufe con conexión a tierra tiene dos espigas iguales y una tercera espiga que sirve para la conexión a tierra. La espiga ancha, o la tercera espiga, sirven para su seguridad. Si el enchufe suministrado no encaja en el tomacorriente, consulte con un electricista para reemplazar el tomacorriente obsoleto.

**Aviso!** Não anule a finalidade da segurança da ficha polarizada ou do tipo ligação terra. Uma ficha polarizada tem duas lâminas sendo uma mais larga do que a outra. Uma ficha do tipo de ligação à terra tem duas lâminas e um terceiro terminal de ligação à terra. A lâmina larga ou o terceiro terminal são fornecidos para sua segurança. Se a ficha fornecida não couber na sua tomada, consulte um electricista para a substituição da tomada obsoleta.

**Avviso!** Non compromettere la sicurezza della spina polarizzata o con messa a terra. Una spina polarizzata ha due spinotti, di cui uno più largo. Una spina con messa a terra ha due spinotti e un terzo polo per la messa a terra. Lo spinotto largo o il terzo polo sono forniti per motivi di sicurezza. Se la spina fornita non si inserisce nella presa di corrente, contattare un elettricista per la sostituzione della presa obsoleta.



**Warning!** Since the Mains plug is used as the disconnection for the device, it must remain readily accessible and operable.

**Avertissement!** Puisque la prise principale est utilisée pour débrancher l'appareil, elle doit rester aisément accessible et fonctionnelle.

**Warnung!** Da der Netzstecker als Trennvorrichtung dient, muss er stets zugänglich und funktionsfähig sein.

**¡Advertencia!** Puesto que el enchufe de la red eléctrica se utiliza como dispositivo de desconexión, debe seguir siendo fácilmente accesible y operable.

**Aviso!** Dado que a ficha principal é utilizada como a desconexão para o dispositivo, esta deve manter-se prontamente acessível e funcional.

**Avviso!** Poiché il cavo di alimentazione viene usato come dispositivo di sconnessione, deve rimanere prontamente accessibile e operabile.



**Warning!** Protect the power cord from being walked on or pinched particularly at plugs, convenience receptacles, and the point where they exit from the device.

**Avertissement!** Protégez le cordon d'alimentation pour que l'on ne marche pas dessus ou qu'on le pince, en particulier au niveau des prises mâles, des réceptacles de convenance, et à l'endroit où il sort de l'appareil.

**Warnung!** Vermeiden Sie, dass auf das Netzkabel getreten oder das Kabel geknickt wird, insbesondere an den Steckern, den Steckdosen und am Kabelausgang am Gerät.

**¡Advertencia!** Proteja el cable de energía para que no se le pise ni apriete, en especial cerca del enchufe, los receptáculos de conveniencia y el punto del que salen del equipo.

**Aviso!** Proteja o cabo de alimentação de ser pisado ou de ser comprimido particularmente nas fichas, em tomadas de parede de conveniência e no ponto de onde sai do dispositivo.

**Avviso!** Proteggere il cavo di alimentazione in modo che nessuno ci cammini sopra e che non venga schiacciato soprattutto in corrispondenza delle spine e del punto in cui esce dal dispositivo.



**Warning!** Unplug this device during lightning storms or when unused for long periods of time.

**Avertissement!** Débranchez cet appareil pendant les orages avec éclairsou s'il est inutilisé pendant de longues périodes.

**Warnung!** Das Gerät ist bei Gewitterstürmen oder wenn es über lange Zeiträume ungenutzt bleibt vom Netz zu trennen.

**¡Advertencia!** Desenchufe este dispositivo durante tormentas eléctricas o cuando no se lo utilice por largos periodos del tiempo.

**Aviso!** Desconecte este dispositivo da tomada durante trovoadas ou quando não é utilizado durante longos períodos de tempo.

**Avviso!** Utilizzare soltanto i collegamenti e gli accessori specificati e/o venduti dal produttore, quali il treppiedi e l'esoscheletro.



**Warning!** Refer all servicing to qualified service personnel. Servicing is required when the device has been damaged in any way, such as power-supply cord or plug is damaged, liquid has been spilled or objects have fallen into the device, the device has been exposed to rain or moisture, does not operate normally, or has been dropped.

**Avertissement!** Référez-vous au personnel de service qualifié pour tout entretien. L'entretien est exigé quand l'appareil a été endommagé de quelque manière que ce soit, par exemple lorsque le cordon d'alimentation ou la prise sont endommagés, que du liquide a été versé ou des objets sont tombés dans l'appareil, que l'appareil a été exposé à la pluie ou à l'humidité, ne fonctionne pas normalement ou est tombé.

**Warnung!** Das Gerät sollte nur von qualifizierten Fachkräften gewartet werden. Eine Wartung ist fällig, wenn das Gerät in irgendeiner Weise beschädigt wurde, wie bei beschädigtem Netzkabel oder Netzstecker, falls Flüssigkeiten oder Objekte in das Gerät gelangen, das Gerät Regen oder Feuchtigkeit ausgesetzt wurde, nicht ordnungsgemäß funktioniert oder fallen gelassen wurde.

**¡Advertencia!** Consulte al personal calificado por cuestiones de reparación. El servicio de reparación se requiere cuando el dispositivo ha recibido cualquier tipo de daño, por ejemplo cable o espigas dañadas, se ha derramado líquido o se han caído objetos dentro del dispositivo, el dispositivo ha sido expuesto a la lluvia o humedad, o no funciona de modo normal, o se ha caído.

**Aviso!** Remeta todos os serviços de manutenção para o pessoal de assistência qualificado. A prestação de serviços de manutenção é exigida quando o dispositivo foi danificado mediante qualquer forma, como um cabo de alimentação ou ficha que se encontra danificado/a, quando foi derramado líquido ou caíram objectos sobre o dispositivo, quando o dispositivo foi exposto à chuva ou à humidade, quando não funciona normalmente ou quando foi deixado cair.

**Avviso!** Fare riferimento al personale qualificato per tutti gli interventi di assistenza. L'assistenza è necessaria quando il dispositivo è stato danneggiato in qualche modo, ad esempio se il cavo di alimentazione o la spina sono danneggiati, è stato rovesciato del liquido è stato rovesciato o qualche oggetto è caduto nel dispositivo, il dispositivo è stato esposto a pioggia o umidità, non funziona correttamente o è caduto



**Warning!** Do not open the chassis. There are no user-serviceable parts inside. Opening the chassis will void the warranty unless performed by an AJA service center or licensed facility.

**Avertissement!** Ne pas ouvrir le châssis. Aucun élément à l'intérieur du châssis ne peut être réparé par l'utilisateur. La garantie sera annulée si le châssis est ouvert par toute autre personne qu'un technicien d'un centre de service ou d'un établissement agréé AJA.

**Warnung!** Öffnen Sie das Gehäuse nicht. Keine der Geräteteile können vom Benutzer gewartet werden. Durch das Öffnen des Gehäuses wird die Garantie hinfällig, es sei denn, solche Wartungsarbeiten werden in einem AJA-Service-Center oder einem lizenzierten Betrieb vorgenommen.

**¡Advertencia!** No abra el chasis. El interior no contiene piezas reparables por el usuario. El abrir el chasis anulará la garantía a menos que se lo haga en un centro de servicio AJA o en un local autorizado.

**Advertência!** Não abra o chassi. Não há internamente nenhuma peça que permita manutenção pelo usuário. Abrir o chassi anula a garantia, a menos que a abertura seja realizada por uma central de serviços da AJA ou por um local autorizado.

**Avvertenza!** Non aprire lo chassis. All'interno non ci sono parti riparabili dall'utente. L'apertura dello chassis invaliderà la garanzia se non viene effettuata da un centro ufficiale o autorizzato AJA.



**Warning!** Disconnect the external AC power supply line cord(s) from the mains power before moving the unit.

**Avertissement!** Retirez le ou les cordons d'alimentation en CA de la source d'alimentation principale lorsque vous déplacez l'appareil.

**Warnung!** Trennen Sie die Wechselstrom-Versorgungskabel vom Netzstrom, bevor Sie das Gerät verschieben.

**¡Advertencia!** Cuando mueva la unidad desenchufe de la red eléctrica el/los cable(s) de la fuente de alimentación CA tipo brick.

**Advertência!** Remova os cabos CA de alimentação brick da rede elétrica ao mover a unidade.

**Avvertenza!** Scollegare il cavo dell'alimentatore quando si sposta l'unità.



**Warning!** Only use attachments and accessories specified and/or sold by the manufacturer.

**Avertissement!** Utilisez seulement les attaches et accessoires spécifiés et/ou vendus par le fabricant.

**Warnung!** Verwenden Sie nur Zusatzgeräte und Zubehör angegeben und / oder verkauft wurde durch den Hersteller.

**¡Advertencia!** Utilice solamente los accesorios y conexiones especificados y/o vendidos por el fabricante.

**Aviso!** Utilize apenas equipamentos/acessórios especificados e/ou vendidos pelo fabricante.

**Avviso!** Utilizzare soltanto i collegamenti e gli accessori specificati e/o venduti dal produttore.



**Hazard!** High Voltage. This situation or condition can cause injury due to electric shock.

**Avertissement!** Tension élevée. Cette situation ou condition peut causer des blessures dues à un choc électrique.

**Warnung!** Hochspannung. Diese Situation oder Bedingung kann zu Verletzungen durch Stromschlag führen.

**¡Advertencia!** Alto voltaje . Esta situación o condición puede causar lesiones debidas a una descarga eléctrica.

**Aviso!** Alta Tensão . Esta situação ou condição pode causar danos devido a choques elétricos.

**Avviso!** Alta tensione. Questa situazione o condizione può causare lesioni a causa di scosse elettriche.



**Caution!** To meet safety regulations for leakage current, connect the dual power supplies to separate branch circuits.

**¡Advertencia!** Para cumplir con las normas de seguridad para la corriente de fuga, conecte las dos fuentes de alimentación para circuitos derivados diferentes.

**Attention!** Pour répondre aux mesures de sécurité concernant le courant de fuite, raccorder les sources d'alimentation doubles à des circuits de dérivation distincts.

**Warnung!** Zur Erfüllung der Sicherheitsbestimmungen bezüglich Reststrom schließen Sie bitte die zwei Netzteile an unterschiedlichen Abzweigleitungen an.

**Cuidado!** Para atender aos regulamentos de segurança para correntes de fuga, conecte as fontes duplas a circuitos elétricos separados.

**Attenzione!** Per soddisfare le norme di sicurezza sulla corrente di perdita, collegare i doppi alimentatori a circuiti derivati separati.





**Warning!** Ensure Mains Power is disconnected before installing the OG-FS-Mini modules into the frame, or installing and removing options. If a Mains switch is not provided, the power cord(s) of this equipment provide the means of disconnection. The socket outlet must be installed near the equipment and must be easily accessible.

**Avertissement !** Avant d'installer des modules OG-FS-Mini dans la structure, ainsi qu'avant d'installer ou d'enlever des options, assurez-vous d'avoir déconnecté l'alimentation électrique. S'il n'y a pas d'interrupteur électrique, il faut débrancher les câbles électriques de l'équipement. La prise électrique doit être située à proximité de l'équipement et doit être aisément accessible.

**Achtung!** Sicherstellen, dass die Netzleitung entkoppelt ist, bevor die OG-FS-Mini Module in das Gestell eingebaut oder Wahlteile eingebaut bzw. ausgebaut werden. Wenn kein Netzschalter vorgesehen ist, dient das bzw. dienen die Netzkabel dieser Vorrichtung als Entkopplungsmittel. Die Steckdose muss in der Nähe der Vorrichtung installiert und leicht zugänglich sein.

**Avvertenza.** Accertarsi che l'alimentazione di rete sia scollegata prima di installare i moduli OG-FS-Mini nel frame o di installare e rimuovere componenti opzionali. Se non è presente un interruttore di accensione/spegnimento, occorre scollegare il cavo (o i cavi) di alimentazione di questo apparecchio dalla presa di corrente. La presa di corrente deve essere situata presso l'apparecchio e facilmente accessibile.

**Aviso!** Certifique-se que a fonte principal de energia elétrica está desconectada antes de instalar os módulos OG-FS-Mini no bastidor ou antes de instalar e remover opções. Se o interruptor principal não existir, o cabo elétrico deste equipamento proporciona o meio de desconexão. A tomada elétrica deverá ser instalada perto do equipamento e deverá ser de fácil acesso.

**¡Advertencia!** Asegúrese que la red de alimentación está desconectada antes de instalar los módulos OG-FS-Mini en el marco, o la instalación y extracción de opciones. Si no se proporciona un conmutador de red, el cable de alimentación de este equipo proporciona los medios de desconexión. El zócalo tomacorriente debe estar instalado cerca del equipo y debe ser fácilmente accesible.



**Warning!** Dual Power Cord Notice—please read this. To reduce the risk of electrical shock, disconnect both power cords before servicing equipment.

**Avertissement !** Avis concernant la double alimentation électrique—à lire soigneusement. Pour éviter tout risque d'électrocution, débranchez les deux câbles électriques avant d'intervenir sur l'équipement.

**Achtung!** Hinweis auf Doppel-Netzkabel-bitte lesen. Um das Risiko eines Elektroschocks zu verringern, müssen beide Netzkabel ausgestöpselt werden, bevor die Vorrichtung gewartet wird.

**Avvertenza.** Avviso concernente il cavo di alimentazione doppio - leggere attentamente. Per ridurre il rischio di elettrocuzione, scollegare entrambi i cavi di alimentazione prima di eseguire la manutenzione o riparazioni di questo apparecchio.

**Aviso!** Aviso de Cabo Elétrico Duplo - por favor, leia isto. Para reduzir o risco de choque elétrico, desconecte ambos os cabos elétricos antes de fazer manutenção ao equipamento.

**¡Advertencia!** Aviso del doble cable de alimentación - leer esto por favor. Para reducir el riesgo de descarga eléctrica, desconecte ambos cables de alimentación antes de dar servicio al equipo.



**Caution!** The OG-X-FR front fan door is heavy. Remove with Caution.

**Attention!** La porte du ventilateur avant OG-X-FR est lourde. Retirer avec précaution.

**Achtung!** Die OG-X-FR -Frontlüfter Tür ist schwer. Bitte vorsichtig entfernen.

**¡Precaución!** La puerta del ventilador frontal OG-X-FR es pesado. Extraer con precaución.

**Atenção!** A porta do ventilador frontal OG-X-FR é pesado. Remova com cuidado.

**Attenzione!** La porta ventola anteriore OG-X-FR è pesante. Rimuovere con cautela.

# Warranty and Liability Information

---

AJA VIDEO SYSTEMS, INC.

## Limited Warranty on Hardware

---

AJA Video Systems, Inc. (AJA Video) warrants that the hardware product, not including storage modules or software components, will be free from defects in materials and workmanship for a period of five (5) years from the date of purchase. AJA Video warrants that the storage modules provided as part of the hardware product will be free from defects in materials and workmanship for a period of one year from the date of purchase. AJA Video provides a separate software warranty as part of the license agreement applicable to software components.

If a hardware product or storage module (hereafter, a “product”) proves to be defective during the applicable warranty period, AJA Video, at its option, will either repair the defective product without charge for parts and labor, or will provide a replacement in exchange for the defective product.

To obtain service under this warranty, the Customer must notify AJA Video of the defect before expiration of the warranty period and make suitable arrangements for the performance of service by contacting AJA Video support through the channels set forth on the support contacts web page at <http://www.aja.com/support>. Except as stated, the Customer shall bear all shipping, packing, insurance and other costs, excluding parts and labor, to effectuate repair. Customer shall pack and ship the defective product to a service center designated by AJA Video, with shipping charges prepaid. AJA Video shall pay to return the product to Customer but only if to a location within the country in which the AJA Video service center is located.

This warranty shall not apply to any defect, failure or damage caused by negligent, inadequate or improper use, handling or maintenance. Without limiting the foregoing, AJA Video shall not be obligated to furnish service under this warranty or repair any damage or malfunction a) resulting from attempts by personnel other than AJA Video representatives to install, repair or service the product, b) resulting from improper use or connection to incompatible equipment, c) caused by the use of non-AJA Video parts or supplies, d) if the product has been modified or integrated with other products when the effect of such a modification or integration increases the time or difficulty of servicing the product, or e) resulting from being dropped or otherwise subjected to undue force, exposure to moisture or other corrosive or conductive substances, exposure to strong magnetic fields, use with improperly regulated power supplies, exposure to electric shock, use in temperatures outside the specified operating range, or otherwise failing to treat the product in accordance with the standard of care appropriate to sensitive and delicate electronic equipment.

EXCEPT AS STATED ABOVE, AJA VIDEO AND ITS VENDORS DISCLAIM IN THEIR ENTIRETY ALL OTHER WARRANTIES, EXPRESS OR IMPLIED, INCLUDING WITHOUT LIMITATION ALL WARRANTIES OF MERCHANTABILITY OR FITNESS FOR A PARTICULAR PURPOSE. AJA VIDEO'S RESPONSIBILITY TO REPAIR OR REPLACE TIMELY REPORTED DEFECTIVE PRODUCTS IS THE WHOLE AND EXCLUSIVE REMEDY CUSTOMER IS PROVIDED WITH RESPECT TO HARDWARE PRODUCTS AND THEIR STORAGE MODULES. SOME JURISDICTIONS DO NOT ALLOW THE EXCLUSION OF IMPLIED WARRANTIES OR LIMITATIONS ON APPLICABLE STATUTORY RIGHTS OF A CONSUMER, SO SOME OR ALL OF THE TERMS OF THIS PARAGRAPH MAY NOT APPLY TO YOU.

THE PRODUCT IS NOT INTENDED, STATED, OR WARRANTED TO OPERATE UNINTERRUPTED OR ERROR-FREE. YOU UNDERSTAND AND ACKNOWLEDGE THAT THE PRODUCT IS NOT INTENDED TO BE USED AS THE SOLE OR PRIMARY DATA SOURCE OR TARGET FOR CRITICAL DATA, AND THAT IT IS YOUR RESPONSIBILITY TO IMPLEMENT REDUNDANT CAPTURE AND BACKUP SYSTEMS AS APPROPRIATE.

## Limitation of Liability

---

Under no circumstances shall AJA video BE LIABLE IN ANY WAY FOR ANY LOST, CORRUPTED OR DESTROYED DATA, FOOTAGE OR WORK, OR FOR ANY OTHER INDIRECT, SPECIAL, INCIDENTAL OR CONSEQUENTIAL DAMAGES OR LOST PROFITS, OR FOR ANY THIRD PARTY CLAIM, IN CONNECTION WITH THE PRODUCT, WHETHER RESULTING FROM DEFECTS IN THE PRODUCT, SOFTWARE OR HARDWARE FAILURE, OR ANY OTHER CAUSE WHATSOEVER, EVEN IF AJA VIDEO HAS BEEN ADVISED OF THE POSSIBILITY OF SUCH DAMAGES. AJA VIDEO'S LIABILITY IN CONNECTION WITH THE PRODUCT SHALL UNDER NO CIRCUMSTANCES EXCEED THE PURCHASE PRICE PAID FOR THE PRODUCT. The foregoing limitations apply even if any remedy set forth in this LIMITED WARRANTY fails of its essential purpose. SOME JURISDICTIONS DO NOT ALLOW THE LIMITATION OF LIABILITY FOR PERSONAL INJURY, OR OF INCIDENTAL OR CONSEQUENTIAL DAMAGES, SO SOME OR ALL OF THE TERMS OF THIS PARAGRAPH MAY NOT APPLY TO YOU.

## Governing Law and Language; Your Rights.

---

This limited warranty is the only warranty provided by AJA Video on the hardware product. It supersedes all prior or contemporaneous understandings regarding such subject matter. No amendment to or modification of this warranty will be binding unless in writing and signed by AJA Video. The laws of the State of California, USA will govern this warranty and any dispute arising from it. Any translation of this Agreement is intended for convenience and to meet local requirements and in the event of a dispute between the English and any non-English versions, the English version of this warranty will govern. This limited warranty gives you specific legal rights and you may have other rights that vary from jurisdiction to jurisdiction, some of which are noted above.

# Index

---

## A

- Add 3:2 Pulldown 21
- AJA Support 2
- Analog Audio 25
- Aspect Convert 22
- Audio Tab Screen 24

## C

- Card Tab Screen 19
- Color Space 23
- Conversion Mode Discussion 8

## D

- DashBoard Control System 12
  - Documentation 18
  - Downloading 18
  - Rebooting 28
  - Requirements 18
  - Setup Tab Screen 25
  - Uploading New Software 26
  - Using 18
- Default Operational Settings 16
- DIP Switch Control 16
- DIP Switches
  - General 17
  - Reference 18
- DIP Switch Settings 17
- Down Convert 21
- Downconvert Mode 9

## F

- Features 4

## G

- General DIP Switches 17

## H

- HDMI Audio 24
- HDMI Tab Screen 23

## I

- Installation 12
  - Cabling 15
  - Front Card Installation 14
  - Rear Card Installation 13
  - WECO audio mating connectors 15
- I/O Connections 6

## L

- Loss of Input 22

## O

- openGear and AJA 5
- Operation 16

- Output Format 21
- Overview 4

## P

- Protocol 23

## R

- Reference DIP Switches 18
- RGB Range 24

## S

- Safety and Compliance 33
- SD Aspect Ratio Convert 11
- Status Tab Screen 20

## T

- Technical Specifications 29
- Technical Support 2

## U

- Up Convert 21
- Upconvert Mode 8
- User Controls 12

## V

- Video Tab Screen 20