

4K/UHD HDMI Over HDBaseT TX/RX with PoE

AT-UHD-EX-70-KIT
User Manual



Please check <http://www.atlona.com/UHD-EX-70-KIT.html>
for the most recent **firmware
update** or **manual**.

Table of Contents

1. Introduction	3
2. Package Contents	3
3. Features	3
4. Before You Start	3
5. Category Cable	4
5. Panel Descriptions	
a. Front Panel	5
b. Rear Panel	5
6. Connection and Installation	6
7. Specifications	7
8. Safety Information	8
9. Warranty	9-10
10. Atlona Product Registration	10

Introduction

With 4K and Dolby TrueHD/DTS-HD Master Audio the UHD-70 extenders provide the best quality experience for an affordable price. The Atlona 4K HDMI extenders provide up to 70 meters (230 feet) of stable audio and video with a simple plug and play connection.

Package Contents

- 1 x AT-UHD-70-EX-TX
- 1 x AT-UHD-70-EX-RX
- 1 x 48V DC desktop power supply
- 1 x IEC C13 power cable
- 2 x Pair of wall/table mount ears
- 2 x Pair of screws for mount ears
- 1 x User Manual

Features

- Extend A/V source signals up to 70 meters (230 feet)
- Passes 4K up to 60Hz at chroma sampling 4:2:0, 8-bit
- Provides PoE (Power over Ethernet) from transmitter to receiver
- Dolby TrueHD, DTS-HD Master Audio, or Dolby Atmos pass through
- Supports 3D up to 36-bit deep color
- Status LEDs for power and HDBaseT link connections
- Supports HDCP 2.2
- 1/4 rack width, install up to 4 extenders on a rack shelf
- Slim 25mm (1") low-profile form factor for easy installation under tables and behind displays
- Mini-B USB for easy field firmware updating

Before you start

- When installing the extenders **DO NOT:**
 Cover the vents
 Install into a sealed wall
 Install into an area without adequate air ventilation

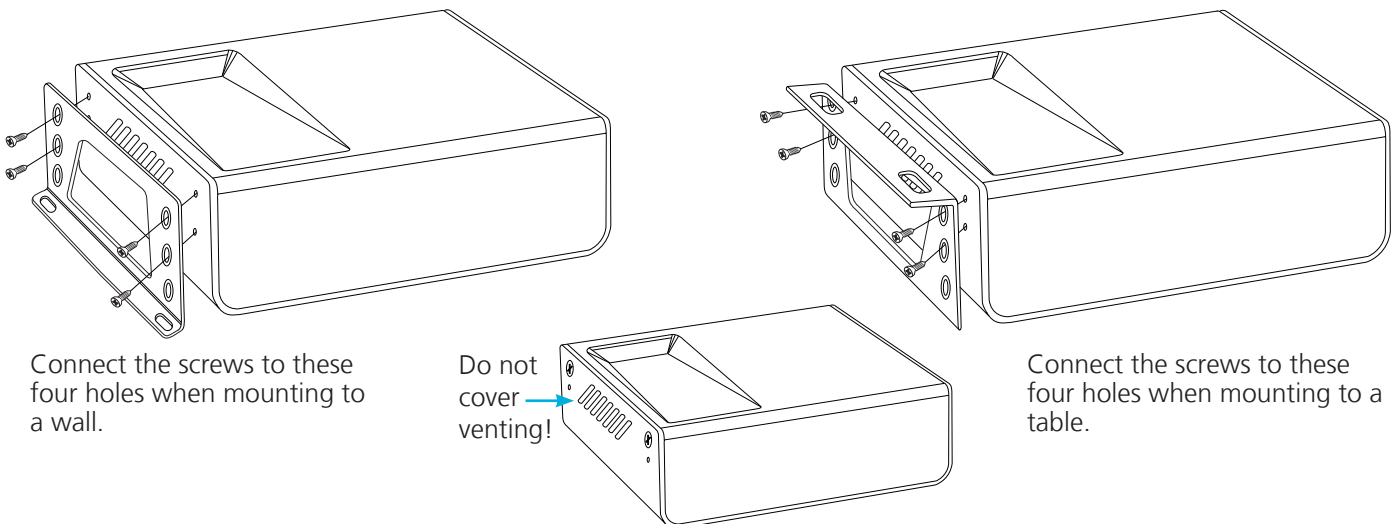

Connect the screws to these four holes when mounting to a wall.

Do not cover venting!

Connect the screws to these four holes when mounting to a table.

*Remove the side screws from the case and use for bracket installation

Category Cable

For the category cables used in these products' installation, please be sure to use a 568B termination as pictured below.

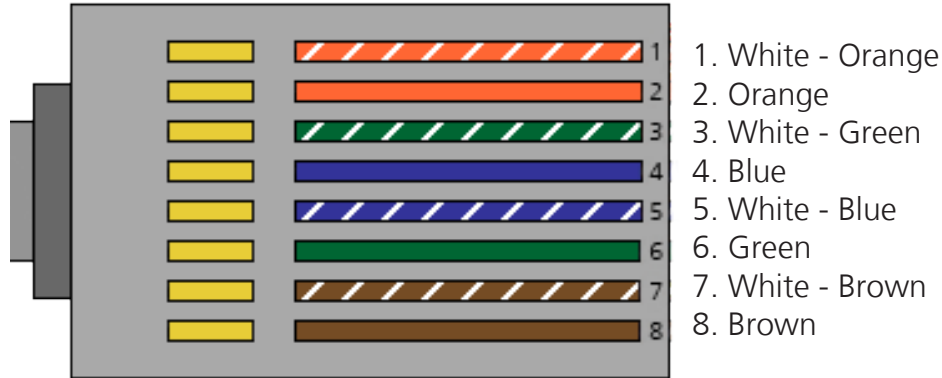

Use the table below to verify the best category cable for the installation.

Performance Rating		Type of LAN cable	
Wiring	Shielding	CAT5e/6	CAT6a/7
Solid	Shielded (STP/FTP)	***	****
	UnShielded (UTP)	**	N/A
Stranded - Patch cable (Not recommended)	Unshielded (UTP)	*	N/A
	Shielded (STP/FTP)	*	N/A
Termination		Please use EIA/TIA-568-B termination	

Important! 4K signals are sensitive to cable quality and installation technique. It is recommended to use CAT6a/7 Solid core cables for best results.

Note: For cable distances see the specifications on page 7

Connector

Connector type and size is very important to ensure extenders work correctly. Please use the matching cable type with the correct RJ45 connector.

CAT5e and CAT 6 cables should use only CAT5e RJ45 connectors

CAT6a cables should use only CAT6a connectors

CAT7 cables should use only CAT7 connectors

Using the wrong size of connectors may result in interference causing loss of signal.

Important! "EZ RJ45 connectors" are not recommended with HDBaseT extenders. Doing so may result in stray EMI/RFI signals to be picked up and interfere with audio and video transmissions.

Panel Description

Transmitter

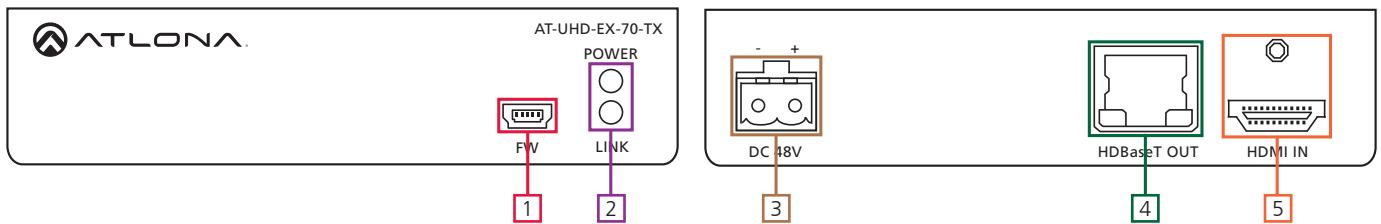

1. Firmware Update Port: Use a Mini-B USB to USB A cable to connect to a Windows computer for updating.
2. Yellow Link LED: Signal Indicator for the HDBaseT OUT port
 Solid - Good signal from the HDBaseT port
 Blinking - HDBaseT port is disconnected or not transmitting signals
 No Light - No signal is being received from the HDBaseT port
Green Power LED: Power indicator. If plugged in light will remain solid. If LED starts blinking power is intermittent or there is a problem with the cable. If the LED is off, no power is passing from the wall outlet to the transmitter (check your outlet or the power cable).
3. Power Port: Connect included power adapter here
4. HDBaseT OUT Port: Connect a category cable from here to an AT-UHD-EX-70-RX (included)
5. HDMI IN Port: Connect HDMI or DVI (with adapter) source here
 Ex. Blu-ray player, cable box, HDDA, H2H series, etc

Receiver

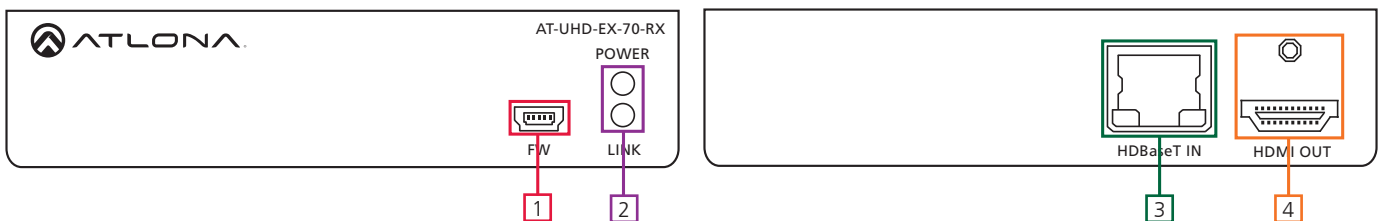

1. Firmware Update Port: Use a Mini-B USB to USB A cable to connect to a Windows computer for updating.
2. Yellow Link LED: Signal Indicator for the HDBaseT IN port
 Solid - Good signal from the HDBaseT ports
 Blinking - HDBaseT port is disconnected or not receiving signals
 No Light - No signal is being received from the HDBaseT port
Green Power LED: Power indicator. If plugged in light will remain solid. If the LED starts blinking power is intermittent or there is a problem with the cable. If the LED is off, no power is passing from the wall outlet to the receiver (check your outlet or the power cable).
3. HDBaseT IN Port: Connect a category cable from here to an AT-UHD-EX-70-TX (included)
4. HDMI OUT Port: Connect HDMI or DVI (with adapter) display here

Power Chaining

Multiple kits can be powered by one power supply. The included power supply can support up to 3 kits. To power four kits use the optional power supply AT-PSU-48V1.25A (purchase through atlona.com).

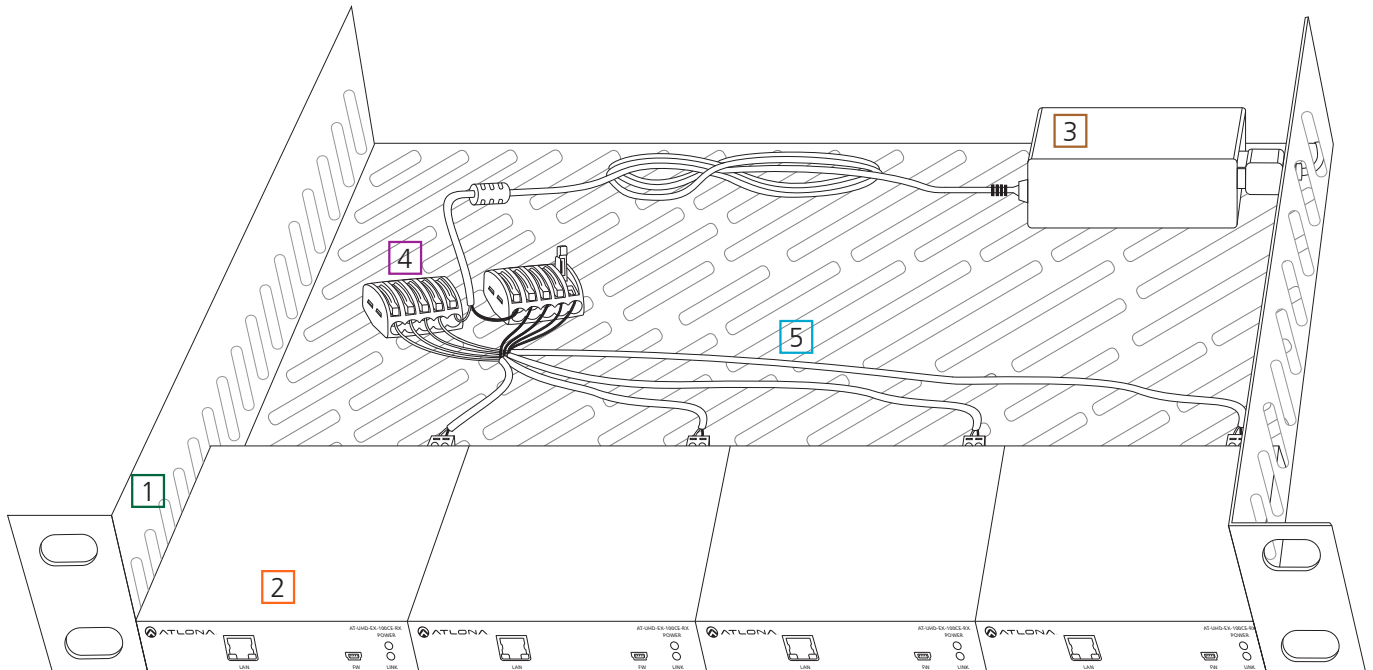

To chain one power supply to three transmitters (four when using AT-PSU-48V1.25A), use two wago splicing connectors, 18/2 AWG stranded wire, a ventilated 1 RU rack shelf, zip ties, and high temperature hook and loop (velcro) strips will be needed.

1. 1 RU rack shelf - Should be at least 10in / 254mm deep, fit in a standard 19" rack, and must be well ventilated. Use the rack screws (included with 19" racks) to secure the rack shelf to the back/front of the rack after power chaining set up is completed.
2. Transmitters - Place 3 or 4 units on the rack shelf. Use high temperature (up to 185°F / 85°C) hook and loop (velcro) to secure the transmitters to the rack.
3. Power supply - Place the included power supply (or the AT-PSU-48V1.25A) on the rack with enough room to connect the included IEC power cable. Use twist ties to secure the power supply and cable to the rack.
4. Wago splicing connectors - Connect the wires from the power supply cable to the wago splicers. Connect the white wire (power/+) to one splicer and the black wire (ground/-) to the second splicer.
Note: Only one wire per port.
5. 18/2 AWG stranded wire - Connect the individual wires to the wago splicers and the transmitter captive screw connectors. There will be two colors of wires (black/red) which will need to be designated - and +. Each color will need to be the same across all connections to ensure no signals are crossed. Strip the ends of each wire and place one end in the appropriate wago connector and the other to the corresponding captive screw connector. Use the zip ties to keep all wires in place and organized.

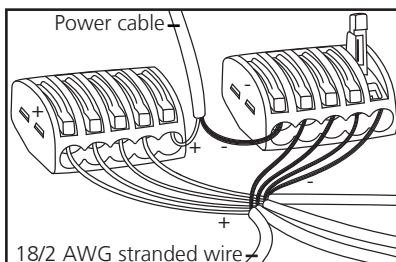

Connection and Installation

Note: When installing extenders, do not install in an enclosed area or cover the vents. Doing so may result in damage to the product and/or area surrounding it and void the warranty.

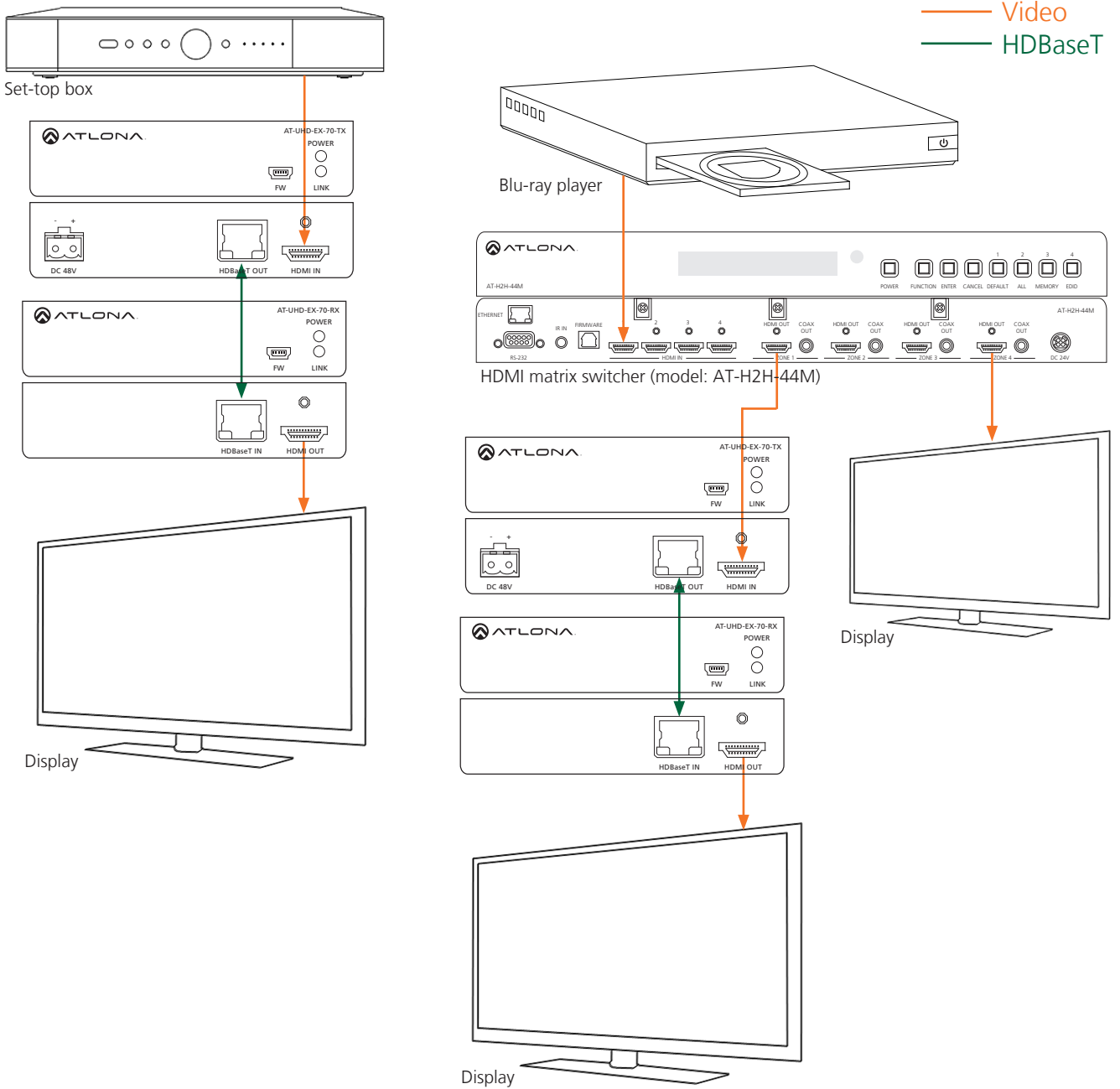

Specifications

Video Resolutions

Video	4096x2160@24/25/30/50*/ 60Hz* , 3840x2160@24/25/30/50*/ 60Hz* (UHD), 2048x1080p, 1080p@23.98/24/25/29.97/30/50/59.94/60Hz, 1080i@50/59.94/60Hz, 720p@50/59.94/60Hz, 576p, 576i, 480p, 480i	
VESA	2560x2048, 2560x1600, 2048x1536, 1920x1200, 1680x1050, 1600x1200, 1600x900, 1440x900, 1400x1050, 1366x768, 1360x768, 1280x1024, 1280x800, 1280x768, 1152x864, 1024x768, 800x600, 640x480	
Colorspace	YCbCr, RGB	
Chroma Subsampling	4:4:4, 4:2:2, 4:2:0 (UHD only)	
Color depth	8-bit, 10-bit, 12-bit	

Audio

Formats	PCM 2Ch, LPCM 5.1, LPCM 7.1, Dolby Digital, DTS 5.1, Dolby Digital Plus, Dolby TrueHD, DTS-HD Master Audio, Dolby Atmos	
Sample Rate	32kHz, 44.1kHz, 48kHz, 88.2kHz, 96kHz, 176.4kHz, 192kHz	
Bit rate	up to 24-bit	

Distance

CAT5e/6 @ 4K	up to 35 meters	up to 115 feet
CAT6a/7 @ 4K	up to 40 meters	up to 130 feet
CAT5e/6 @ 1080p	up to 60 meters	up to 197 feet
CAT6a/7 @ 1080p	up to 70 meters	up to 230 feet
HDMI 4K	up to 5 meters	up to 15 feet
HDMI 1080p	up to 10 meters	up to 30 feet

Signal

Bandwidth	10.2 Gbps
CEC	Yes
HDCP	2.2 Compliant

Temperature

Operating	0°C to 50°C	32°F to 122°F
Storage	-20°C to 60°C	-4°F to 140°F
Humidity	20 to 90% non-condensing	

Power

Consumption	10.8W (paired)
Supply	Input: AC 100~240V 50/60Hz Output: DC 48V 0.83A

Dimension

H x W x D	26 x 109 x 89 (mm)	1.02 x 4.29 x 3.50 (inch)
w/ears	28 x 129 x 89 (mm)	1.10 x 4.69 x 3.50 (inch)

Weight

TX	0.29 kg	0.64 lbs
RX	0.27 kg	0.59 lbs

Certification

Power Supply	CE, FCC, cULus, RoHS, CCC, RCM
Product	CE, FCC

**4096x2160@50/60Hz & 3840x2160@50/60Hz supported @ chroma subsampling 4:2:0 8-bit only

Safety Information

Safeguards



To reduce the risk of electric shock, do not expose this product to rain or moisture



Do not modify the wall plug. Doing so will void the warranty and safety features.



If the wall plug does not fit into your local power socket, hire an electrician to replace your obsolete socket.



This equipment should be installed near the socket outlet and the device should be easily accessible in the case it requires disconnection.

Precautions

FCC regulations state that any unauthorized changes or modifications to this equipment, not expressly approved by the manufacturer, could void the user's authority to operate this equipment.

Operate this product using only the included external power supply. Use of other power supplies could impair performance, damage the product, or cause fires.

In the event of an electrostatic discharge this device may automatically turn off. If this occurs, unplug the device and plug it back in.

Protect and route power cords so they will not be stepped on or pinched by anything placed on or against them. Be especially careful of plug-ins or cord exit points from this product.

Avoid excessive humidity, sudden temperature changes or temperature extremes.

Keep this product away from wet locations such as bathtubs, sinks, laundries, wet basements, fish tanks, and swimming pools.

Use only accessories recommended by Atlona to avoid fire, shock, or other hazards.

Unplug the product before cleaning. Use a damp cloth for cleaning and not cleaning fluid or aerosols. Such products could enter the unit and cause damage, fire, or electric shock. Some substances may also mar the finish of the product.

Never open, remove unit panels, or make any adjustments not described in this manual. Attempting to do so could expose you to dangerous electrical shock or other hazards. It may also cause damage to your product. Opening the product will void the warranty.

Do not attempt to service the unit. Disconnect the product and contact your authorized Atlona reseller or contact Atlona directly.

Atlona, Inc. (“Atlona”) Limited Product Warranty Policy

Coverage

Atlona warrants its products will substantially perform to their published specifications and will be free from defects in materials and workmanship under normal use, conditions and service.

Under its Limited Product Warranty, Atlona, at its sole discretion, will either:

- A) repair or facilitate the repair of defective products within a reasonable period of time, restore products to their proper operating condition and return defective products free of any charge for necessary parts, labor and shipping
- OR**
- B) replace and return, free of charge, any defective products with direct replacement or with similar products deemed by Atlona to perform substantially the same function as the original products
- OR**
- C) refund the pro-rated value based on the remaining term of the warranty period, not to exceed MSRP, in cases where products are beyond repair and/or no direct or substantially similar replacement products exist.

Repair, replacement or refund of Atlona’s products is the purchaser’s exclusive remedy and Atlona’s liability does not extend to any other damages, incidental, consequential or otherwise.

This Limited Product Warranty extends to the original end-user purchaser of Atlona’s products and is non-transferrable to any subsequent purchaser(s) or owner(s) of these products.

Coverage Periods

Atlona’s Limited Product Warranty Period begins on the date of purchase by the end-purchaser. The date contained on the end-purchaser’s sales or delivery receipt is the proof purchase date.

Limited Product Warranty Terms – New Products

- 10 years from proof of purchase date for hardware/electronics products purchased on or after June 1, 2013
- 3 years from proof of purchase date for hardware/electronics products purchased before June 1, 2013
- Lifetime Limited Product Warranty for all cable products

Limited Product Warranty Terms – Refurbished (B-Stock) Products

- 3 years from proof of purchase date for all Refurbished (B-Stock) hardware and electronic products purchased on or after June 1, 2013

Remedy

Atlona recommends that end-purchasers contact their authorized Atlona dealer or reseller from whom they purchased their products. Atlona can also be contacted directly. Visit www.atlona.com for Atlona’s contact information and hours of operation. Atlona requires that a dated sales or delivery receipt from an authorized dealer, reseller or end-purchaser is provided before Atlona extends its warranty services. Additionally, a return merchandise authorization (RMA) and/or case number, is required to be obtained from Atlona in advance of returns.

Atlona requires that products returned are properly packed, preferably in the original carton, for shipping. Cartons not bearing a return authorization or case number will be refused. Atlona, at its sole discretion, reserves the right to reject any products received without advanced authorization. Authorizations can be requested by calling 1-877-536-3976 (US toll free) or 1-408- 962-0515 (US/international) or via Atlona’s website at www.atlona.com.

Exclusions

This Limited Product Warranty excludes:

- Damage, deterioration or malfunction caused by any alteration, modification, improper use, neglect, improper packing or shipping (such claims must be presented to the carrier), lightning, power surges, or other acts of nature.
- Damage, deterioration or malfunction resulting from the installation or removal of this product from any installation, any unauthorized tampering with this product, any repairs attempted by anyone unauthorized by Atlona to make such repairs, or any other cause which does not relate directly to a defect in materials and/or workmanship of this product.
- Equipment enclosures, cables, power supplies, batteries, LCD displays, and any accessories used in conjunction with the product(s).
- Products purchased from unauthorized distributors, dealers, resellers, auction websites and similar unauthorized channels of distribution.

Disclaimers

This Limited Product Warranty does not imply that the electronic components contained within Atlona's products will not become obsolete nor does it imply Atlona products or their electronic components will remain compatible with any other current product, technology or any future products or technologies in which Atlona's products may be used in conjunction with. Atlona, at its sole discretion, reserves the right not to extend its warranty offering in instances arising outside its normal course of business including, but not limited to, damage inflicted to its products from acts of god.

Limitation on Liability

The maximum liability of Atlona under this limited product warranty shall not exceed the original Atlona MSRP for its products. To the maximum extent permitted by law, Atlona is not responsible for the direct, special, incidental or consequential damages resulting from any breach of warranty or condition, or under any other legal theory. Some countries, districts or states do not allow the exclusion or limitation of relief, special, incidental, consequential or indirect damages, or the limitation of liability to specified amounts, so the above limitations or exclusions may not apply to you.

Exclusive Remedy

To the maximum extent permitted by law, this limited product warranty and the remedies set forth above are exclusive and in lieu of all other warranties, remedies and conditions, whether oral or written, express or implied. To the maximum extent permitted by law, Atlona specifically disclaims all implied warranties, including, without limitation, warranties of merchantability and fitness for a particular purpose. If Atlona cannot lawfully disclaim or exclude implied warranties under applicable law, then all implied warranties covering its products including warranties of merchantability and fitness for a particular purpose, shall provide to its products under applicable law. If any product to which this limited warranty applies is a "Consumer Product" under the Magnuson-Moss Warranty Act (15 U.S.C.A. §2301, ET SEQ.) or other applicable law, the foregoing disclaimer of implied warranties shall not apply, and all implied warranties on its products, including warranties of merchantability and fitness for the particular purpose, shall apply as provided under applicable law.

Other Conditions

Atlona's Limited Product Warranty offering gives legal rights, and other rights may apply and vary from country to country or state to state. This limited warranty is void if (i) the label bearing the serial number of products have been removed or defaced, (ii) products are not purchased from an authorized Atlona dealer or reseller. A comprehensive list of Atlona's authorized distributors, dealers and resellers can be found at www.atlona.com.

Atlona, Inc Product Registration

Thank you for purchasing this Atlona product. - We hope you enjoy it and will take an extra few moments to register your new purchase.

Registration creates an ownership record if your product is lost or stolen and helps ensure you'll receive notification of performance issues and firmware updates.

At Atlona we respect and protect your privacy, assuring you that your registration information is completely secure. Atlona product registration is completely voluntary and failure to register will not diminish your limited warranty rights.

To register go to: <http://www.atlona.com/registration>