

TAHOMA Platform

Multiviewers

HARDWARE MANUAL

Version 2.0

Dated: August 5, 2010



© 2010 Apantac LLC - All rights reserved

The contents of this document are provided in connection with Apantac LLC ("Apantac") products. Apantac makes no representations or warranties with respect to the accuracy or completeness of the contents of this publication and reserves the right to make changes to specifications and product descriptions at any time without notice.

APANTAC LLC • 7556 SW BRIDGEPORT ROAD • PORTLAND, OR 97224, USA
PHONE +1 503 616 3711 • FAX +1 503 389 7921 • INFO@APANTAC.COM • WWW.APANTAC.COM

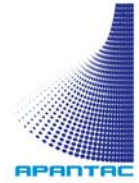
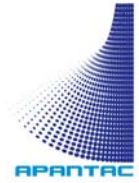
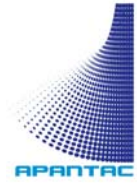

TABLE OF CONTENTS

<i>TRADEMARKS</i>	4
<i>COMPLIANCE INFORMATION</i>	4
<i>Limitation of Liability</i>	5
<i>Extended Warranty Options</i>	6
<i>Services and Repairs Outside the Warranty Period</i>	6
<i>Disclaimer</i>	6
<i>Operating Environment</i>	6
<i>DEFINITIONS</i>	7
<i>INTRODUCTION TO TAHOMA MULTIVIEWERS</i>	8
<i>HARDWARE</i>	8
<i>TAHOMA PLATFORM PRODUCT LINE</i>	9
<i>LE Series</i>	9
<i>LI Series</i>	10
<i>LX Series</i>	11
<i>DE Series</i>	14
<i>LC Series</i>	15
<i>TECHNICAL SPECIFICATIONS</i>	15
<i>PHYSICAL SPECIFICATIONS</i>	20
<i>Tahoma LE-4</i>	20
<i>Tahoma LE-8 / LE-16</i>	22
<i>Tahoma LE-20 / LE-24 / LE-28 / LE-32</i>	24
<i>Tahoma LI-4 / LI-8</i>	26
<i>Tahoma LI-12 / LI-16</i>	28
<i>Tahoma LX-4 / LX-8 / LX12 / LX-16</i>	30
<i>Tahoma LX-16-32 / LX-20 / LX-24 / LX-28 / LX-32</i>	32
<i>Tahoma DE-4 / DE-8</i>	34
<i>Tahoma DE-12 / DE-16</i>	36
<i>PRODUCT CONTENTS - "WHAT'S IN THE BOX"</i>	37
<i>Overview of TAHOMA Platform Models</i>	41
<i>TAHOMA LE MODELS</i>	41
<i>Analog composite video inputs</i>	41
<i>SD-SDI/analog composite video inputs</i>	41



<i>HD/SD-SDI/analog composite video inputs</i>	42
<i>TAHOMA LI MODELS</i>	42
<i>Analog composite video inputs</i>	42
<i>SD-SDI</i>	43
<i>HD/SD-SDI</i>	43
<i>TAHOMA LX MODELS</i>	44
<i>SD-SDI</i>	44
<i>HD/SD-SDI</i>	44
<i>TAHOMA DE MODELS</i>	45
<i>INSTALLATION</i>	46
<i>OPERATION</i>	49
<i>Optional Hardware</i>	49
<i>TAHOMA MULTIVIEWER SETUP EXAMPLES</i>	50
<i>ACCESSORIES</i>	57
<i>Standard Accessories:</i>	57
<i>Optional Accessories:</i>	58
<i>APPENDIX A: CONNECTORS</i>	59
<i>APPENDIX B: REDUNDANT POWER SUPPLIES</i>	64
<i>CONTACT APANTAC</i>	67



TRADEMARKS

Apantac, Tahoma, and MT Hood are registered trademarks of Apantac LLC. All other trademarks are the property of their respective holders.

Notice:

Copyright © 2010 Apantac LLC. All rights reserved. All information in this manual is subject to change without notice. No part of the document may be reproduced or transmitted in any form, or by any means, electronic or mechanical, including photocopying or recording, without the express written permission of Apantac LLC.

COMPLIANCE INFORMATION

The Apantac equipment has been tested to comply with the following.

- FCC - Class A
This equipment has been tested and found to comply with the limits for a Class A digital device, pursuant to part 15 of the FCC Rules. These limits are designed to provide reasonable protection against harmful interference when the equipment is operated in a commercial environment. This equipment generates, uses, and can radiate radio frequency energy and, if not installed and used in accordance with the instruction manual, may cause harmful interference to radio communications. Operation of this equipment in a residential area is likely to cause harmful interference in which case the user will be required to correct the interference at his or her own expense.
- CE
- C-Tick
- RoHS

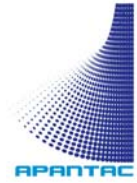

WARRANTY STATEMENT

Apantac LLC (herein after referred to as "Apantac") warrants to the original purchaser of the products manufactured by Apantac (the "Product,") will be free from defects in material and workmanship for a period of three (3) year from the date of shipment of the Product to the purchaser.

If the Product proves to be defective during the three (3) year warranty period, the purchaser's exclusive remedy and Apantac's sole obligation under this warranty is expressly limited, at Apantac's sole option, to:

- (a) repair the defective Product without charge for parts and labor or,
- (b) provide a replacement in exchange for the defective Product or,
- (c) if after a reasonable time, is unable to correct the defect or provide a replacement Product in good working order, then the purchaser shall be entitled to recover damages subject to the limitation of liability set forth below.

Limitation of Liability

Apantac's liability under this warranty shall not exceed the purchase price paid for the defective product. In no event shall Apantac be liable for any incidental, special or consequential damages, including without limitation, loss of profits for any breach of this warranty.

If Apantac replaces the defective Product with a replacement Product as provided under the terms of this Warranty, in no event will the term of the warranty on the replacement Product exceed the number of months remaining on the warranty covering the defective Product.

Equipment manufactured by other suppliers and supplied by Apantac carries the respective manufacturer's warranty. Apantac assumes no warranty responsibility either expressed or implied for equipment manufactured by others and supplied by Apantac.

This hardware warranty shall not apply to any defect, failure or damage:

- a) Caused by improper use of the Product or inadequate maintenance and care of the Product;
- b) Resulting from attempts by those other than Apantac representatives to install, repair, or service the Product;
- c) Caused by installation of the Product in a hostile operating environment or connection of the Product to incompatible equipment;

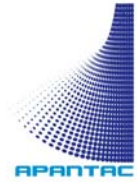

- d) Caused by the modification of the Product or integration with other products when the effect of such modification or integration increases the time or difficulties of servicing the Product. Any Product which fails under conditions other than those specifically covered by the Hardware Warranty, will be repaired at the price of parts and labor in effect at the time of repair. Such repairs are warranted for a period of ninety (90) days from date of reshipment to customer.

Extended Warranty Options

Apantac offers *OPTIONAL* Extended Warranty plans that provide continuous coverage for the Product after the expiration of the Warranty Period. Please contact an Apantac sales representative for details on the options that are available for your Apantac equipment.

Services and Repairs Outside the Warranty Period

Apantac makes its best offer to repair products that are outside the warranty period, provided the product has not reached its end of life.

Disclaimer

Use of this product is limited to the intended design purpose. Any damage caused by use other than the design purpose will void the above warranty.

Operating Environment

Apantac Tahoma Multiviewers should be operated in an environment that is safe for sensitive electronic equipment. It should not be placed in hot, dusty, or humid locations without adequate cooling, filtration, or ventilation.

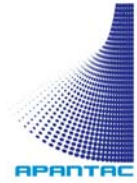

DEFINITIONS

- Tahoma: The common platform for the current Apantac family of Multiviewers
- Tahoma LE: The LE series is capable of auto-detecting composite, SD-SDI, HD-SDI and 3G inputs. Each input is directly corresponded in a window on a display
- Tahoma LI: The LI series comes with LOOPING INPUTS. It is capable of auto-detecting SD-SDI, HD-SDI and 3G inputs. There is also a composite only model. Each input is directly corresponded in a window on a display
- Tahoma LX: The LX series has a built in MATRIX ROUTING SWITCHER. It is capable of auto-detecting SD-SDI, HD-SDI and 3G inputs. Any input can be assigned to any output.
- Tahoma LC: The LC series is an entry level FIXED QUAD SPLIT only Multiviewer. It is capable of auto-detecting SD-SDI, HD-SDI and 3G inputs. Each input is directly corresponded in a window
- Tahoma DE: The DE series is a Multiviewer with UNIVERSAL inputs. It is capable of auto-detecting HDMI, DVI, VGA, composite and component inputs. SD-SDI, HD-SDI and 3G inputs are also available. Each input is directly corresponded in a window on a display

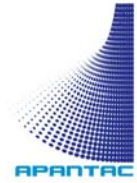

INTRODUCTION TO TAHOMA MULTIVIEWERS

The Apantac Tahoma Multiviewer platform displays multiple auto-detecting video inputs at different formats on a high resolution display up to resolutions of 2048x1080. The Tahoma Platform combines the display of video windows, audio meters, label/UMD, tallies, alarms and indicators in a very space efficient package. Depending on the model, the Tahoma Platform supports auto-detecting of analog composite, SD-SDI, HD-SDI, HDMI, DVI, VGA, component, YC, YPbPr video.

HARDWARE

The Apantac Tahoma Multiviewer Platform consists of 4 different sizes of mechanical frames to serve the needs of broadcast, professional AV and surveillance markets. These frames are ½ width of 1 RU, 1 RU, RU and 3RU. Each Multiviewer frame has a unique IP address, which allows a PC/laptop to easily connect and configure the display layouts.

The Tahoma LE consists of 4 electronic elements;

1. VPM -> Video Processing Module
2. URM -> Universal Receiver Module
3. CPM -> Control module
4. PSM -> Power Supply Module.

The URM module allows flexible field upgrades from composite video all the way to 3G HD-SDI by simply swapping out a board. Future upgrades to computer/data inputs and network (ASI) inputs are also available.

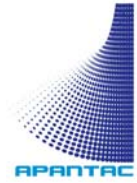

TAHOMA PLATFORM PRODUCT LINE

LE Series

Three types of mechanical frames are available for the Tahoma LE family:

1. **Tahoma-LE-4:** The ½ 1RU LE-4 accepts up to 4 various video standards (from analog composite to HD-SDI) and comes standard with 16 channels of embedded audio per every SDI video input. The LE-4 outputs DVI/HDMI (1.2/1.3) / VGA at user selectable resolutions up to 2048x1080. Analog or AES audio options can be added at any time during or after the purchase.
2. **Tahoma-LE-8 / LE16:** The 1 RU LE-16 accepts up to 16 various video standards (from analog composite to HD-SDI) and comes standard with 16 channels of embedded audio per every SDI video input. The LE-16 has 4 flexible DVI/HDMI (1.2/1.3)/VGA outputs* with user selectable resolutions up to 2048x1080. Analog or AES audio options can be added at any time during or after the purchase.

*Flexible Outputs – LE-16 examples:

Output(s)				
	1	2	3	4
Inputs	4	4	4	4
Inputs	4	4	8	
Inputs	8		8	
Inputs	12			4
Inputs	16			

3. **Tahoma-LE-20 / LE-24 / LE-28 / LE 32:** The 2RU LE-32 accepts up to 32 various video standards (from analog composite to HD-SDI) and comes standard with 16 channels of embedded audio per every SDI video input. The LE-32 has 8 flexible DVI/HDMI (1.2/1.3) / VGA outputs* at user selectable resolutions up to 2048x1080. Analog or AES audio options can be added to the LE-32 at any time during or after the purchase.

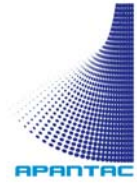

*Flexible Outputs – LE-32 examples:

Output(s)								
	1	2	3	4	5	6	7	8
Inputs	4	4	4	4	4	4	4	4
Inputs	4	4	4	4	4	4	8	
Inputs	4	4	4	4	8		8	
Inputs	4	4	8		8		8	
Inputs	4	4	4	4	8	12		
Inputs	8		8		8		8	
Inputs	8		16				4	4
Inputs	4	8		8		12		
Inputs	4	4	8		16			
Inputs	8		12			12		
Inputs	4	12			16			
Inputs	8		8		16			
Inputs	4	8		20				
Inputs	4	4	24					
Inputs	4	28						
Inputs	8		24					
Inputs	12			20				
Inputs	16				16			
Inputs	32							

LI Series

Note: The LI series does not support composite, SD-SDI, HD-SDI simultaneously. The LI-xxHD, supports both SD-SDI and HD-SDI, the LI-xxCV supports analog composite.

Two types of mechanical frames are available for the Tahoma LI family:

1. **Tahoma-LI4 / LI-8:** The 1 RU Tahoma LI accepts 4-8 SD-SDI, HD-SDI signals, has a looping output for every input, and comes standard with 16 channels of embedded audio per every SDI video input. The LI-8 has two flexible DVI/HDMI (1.2/1.3) / VGA outputs* with user selectable resolutions up to 2048x1080. Analog or AES audio options can be added at any time during or after the purchase.

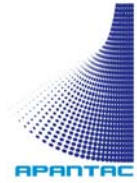

*Flexible Outputs – LI-8 examples:

Output(s)		
	1	2
Inputs	4	4
Inputs	8	

Tahoma-LI-12 / LI-16: The 2RU Tahoma LI accepts 8-16 SD-SDI, HD-SDI signals, has a looping output for every input, and comes standard with 16 channels of embedded audio per every SDI video input. The LI-12 / LI16 has four flexible DVI/HDMI (1.2/1.3)/VGA outputs* with user selectable resolutions up to 2048x1080. Analog or AES audio options can be added at any time during or after the purchase.

*Flexible Outputs – LI-16 examples:

Output(s)				
	1	2	3	4
Inputs	4	4	4	4
Inputs	4	4		8
Inputs	8		8	
Inputs	12			4
Inputs	16			

LX Series

Note: The LX series does not support analog composite inputs.

Two types of mechanical frames are available for the Tahoma LX family:

1. **Tahoma-LX-4 / LX-8 / LX16:** The 1 RU Tahoma LX-4 / LX-8 / LX16 has a built-in 16x16 SDI routing matrix switch that supports any input to any output. It accepts 4-16 various video standards (SD-SDI to HD-SDI) and comes standard with 16 channels of embedded audio per every SDI video input. The LX-4 / LX-8 / LX16 has up to 4 flexible DVI/HDMI (1.2/1.3) / VGA outputs* with user selectable resolutions up to 2048x1080. Analog or AES audio options can be added at any time during or after the purchase.

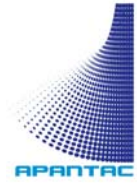

*Flexible Outputs – LX-4 / LX-8 / LX16 examples:

Output(s)				
	1	2	3	4
Inputs	4	4	4	4
Inputs	4	4	8	
Inputs	8		8	
Inputs	12			4
Inputs	16			

- Tahoma-LX-16/32 / LX-20 / LX-24 / LX-28 / LX-32:** The 3 RU LX-16–32 / LX-20 / LX-24 / LX-28 / LX-32 has a built-in 32x32 router which supports any input to any output. It accepts 16-32 various video standards (SD-SDI to HD-SDI) and comes standard with 16 channels of embedded audio per every SDI video input. The LX-16–32 / LX-20 / LX-24 / LX-28 / LX-32 have up to 8 flexible DVI/HDMI (1.2/1.3) / VGA outputs* with user selectable resolutions up to 2048x1080. Analog or AES audio options can be added to the LX-16 at any time during or after the purchase.

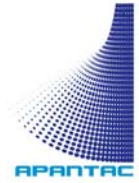

*Flexible Outputs – LX-16-32 / LX-20 / LX-24 / LX-28 / LX-32 examples:

Output(s)									
	1	2	3	4	5	6	7	8	
Inputs	4	4	4	4	4	4	4	4	
Inputs	4	4	4	4	4	4	8		
Inputs	4	4	4	4	8		8		
Inputs	4	4	8		8		8		
Inputs	4	4	4	4	4	12			
Inputs	8		8		8		8		
Inputs		18	16			4	4		
Inputs	4	8		8		12			
Inputs	4	4	8		16				
Inputs	8		12			12			
Inputs	4			12				16	
Inputs	8		8	16					
Inputs	4	8		20					
Inputs	4	4	24						
Inputs	4	28							
Inputs	8		24						
Inputs	12			20					
Inputs	16				16				
Inputs	32								

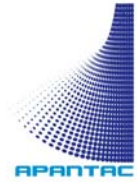

DE Series

Two types of mechanical frames are available for the Tahoma DE family:

1. **Tahoma-DE-4 / DE-8:** The 1 RU Tahoma DE-4 / DE-8 accepts 4-8 video inputs including from HDMI, DVI, VGA, composite, YC, component, SD-SDI to HD-SDI. The DE-4 / DE-8 has two flexible DVI/HDMI (1.2/1.3) / VGA outputs* with user selectable resolutions up to 2048x1080. Analog or AES audio options can be added at any time during or after the purchase.

*Flexible Outputs – DE-4 / DE-8 examples:

Output(s)		
	1	2
Inputs	4	4
Inputs	8	

2. **Tahoma-DE-12 / DE-16:** The 2 RU Tahoma DE-12 / DE-16 accepts 4-16 video inputs including HDMI, DVI, VGA, composite, YC, component, SD-SDI to HD-SDI. The DE-12 / DE-16 has four flexible DVI/HDMI (1.2/1.3) / VGA outputs* with user selectable resolutions up to 2048x1080. Analog or AES audio options can be added at any time during or after the purchase.

*Flexible Outputs – DE-12 / DE-16 examples:

Output(s)				
	1	2	3	4
Inputs	4	4	4	4
Inputs	4	4	8	
Inputs	8		8	
Inputs	12			4
Inputs	16			

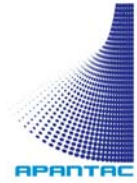

LC Series

Tahoma-LC-4HD: The LC-4HD Quad-Split accepts up to 4 various video inputs including analog composite, SD-SDI, HD-SDI and comes standard with 4 channels of embedded audio per every SDI video input. The LC-4HD supports 4 outputs DVI/HDMI (1.2/1.3) / VGA at user selectable resolutions up to 2048x1080. Analog or AES audio options can be added at any time during or after the purchase.

TECHNICAL SPECIFICATIONS

- 3G ready. Upgradable to 3Gbit/s HD inputs
- Auto detect HD-SD/SDI/CV 50/60Hz (available formats depends on the model)
- Auto detect HDMI/DVI/VGA/CV/YC/component (available formats depends on the model)
- Output resolution up to 2048x1080 (720x480 – 2048x1080)
- Digital and Analog clocks can be synchronized with NTP or LTC (timecode)
- Up to 30 presets for display layout
- Presets can be recalled via GPI, front panel buttons or ASCII protocol via network or serial
- On Screen Display (OSD) for labels, border and alarms can be customizable via Apantac skin technology with industry standard graphical tools
- Auto-detect aspect ratio between 16x9 and 4x3
- Communication interface via IP or RS232
- Supports Apantac eXtended Protocol (AXP)
- Supports direct TSL tally/UMD interface
- Supports multiple languages (including 2 byte characters)
- Supports SDI output (optional)

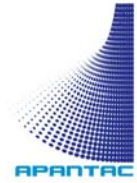

Table 1: Serial Video input

Standards	Upgradable to 3Gb/s (SMPTE 424M) HD-SDI (SMPTE 292M) SD-SDI (SMPTE 259M-C) PAL/NTSC
Connector	BNC
Equalization	Automatic to 140m (Belden 1694A)
Return Loss	15db up to 270mb/s
Embedded Audio	SMPTE 272-A

Table 2: Video Formats supported

480i	720p/30	1080p/23.98	2048x1080p/23.98
480p	720p/50	1080p/24	2048x1080p/24
576i	720p/59.94	1080p/25	
576p	720p/60	1080p/29.97	
720p/23.98	1035i/59.94	1080p/30	
720p/24	1035i/60	1080sf/23.98	
720p/25	1080i/50	1080sf/24	
720p/29.97	1080i/59.94	1080sf/30	

Table 3: Computer Formats supported (50/60Hz)

720x480	852x480	1024x768	1280x768
800x600	1280x960	1280x1024	1360x768
1280x800	1400x900	1400x1050	1600x1200
1366x768	1920x1080	1920x1200	1680x1050

Table 4: Audio input

Type	Default	Option
AES	75 Ω unbalanced via BNC	110 Ω balanced via XLR
Analog Stereo	Unbalanced via BNC	balanced via XLR

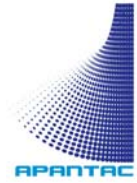

Table 5: Display Output

Standards	DVI-D, HDMI 1.2/3, VGA up to 2048x1080, SDI
Connector	RJ45 (with transmitter), BNC
Impedance	100Ω, 75Ω

Table 6: Audio Outputs

Type	Number/type/connector	Location	Adjustment
AES	1 / unbalanced / BNC	Rear Panel	None, Line Level
Stereo Analog	1 / unbalanced / phone jack	Rear Panel	None, Line Level
Stereo Analog	1 / unbalanced / phone jack	Front Panel	Front Panel knob

Table 7: Output Resolution (50 and 60Hz)

720x480	852x480	1024x768	1280x768
800x600	1280x960	1280x1024	1360x768
1280x800	1400x1050	1600x1200	1680x1050
1366x768	1920x1080	1920x1200	2048x1080

Table-8: General Purpose Interface I/O

Number	On VPM	On CPM
Inputs	8, assignable to input or output	8, assignable to input or output
Outputs	8, assignable to input or output	8, assignable to input or output
Connector	DB9	RJ50 to DB9

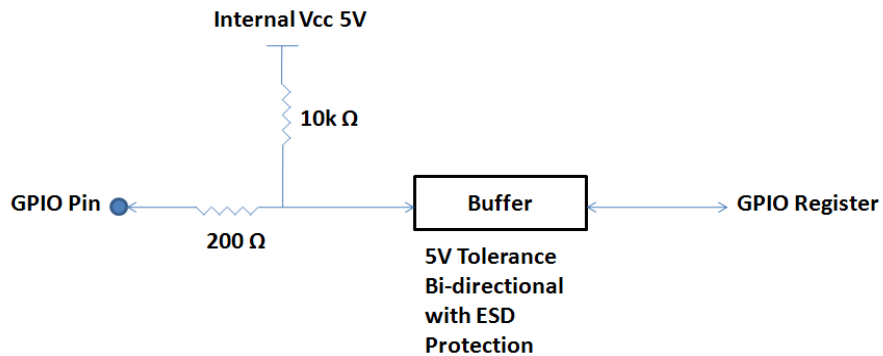

Figure 1: GPI/O Electrical Characteristics

Table 9: Serial Port

Number of Ports	1 x RS232
Adapter	RS232 to RS422 or RS485 (optional)
Connector	RJ45
Baud Rate	Up to 115200
UMD support	Native to TSL and TSI, other third party protocols via Apantac UIM*

Table 10: Ethernet

Network Type	Fast Ethernet 100 Base-TX
Connector	RJ45
Cable	Auto-detect. Either straight or crossed cable will work
UMD support	Native to TSL and TSI, other third party protocols via Apantac UIM*

*UIM – Universal Interface Module. The UIM is a small footprint router protocol translator that acts as a bridge between the Tahoma platform of Multiviewers and other third party router, tally and UMD protocols. The UIM can support third-party TCP/IP, UDP as well as serial protocols. The UIM can also act as an SNMP agent for the Apantac Tahoma Multiviewers.

Table 11: Timecode

Timecode	LTC
Connector	BNC

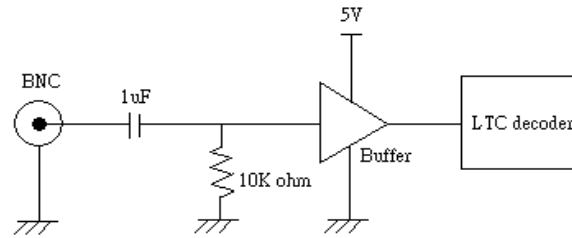
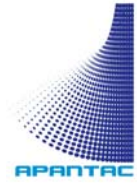

Figure 2: LTC Electrical Characteristics



PHYSICAL SPECIFICATIONS

Tahoma LE-4

Table 12: Tahoma LE-4 Physical Specifications

Size	H: 1.75 in (4.45 cm, 1RU), W: 8.5 in (21.6 cm), D: 13 in (33 cm)
Rack installation	1/2 of standard 19-inch equipment rack. 2 Tahoma LE-4's can be connected together with the interconnect kit mounted in a single RU, or a blank panel is provide to mount a single Tahoma LE on a single RU.
Weight	6 lbs. (2.8kg)
Power	90/250 VAC, 60/50Hz, 25 W, internal auto switchable
Operating Temperature	0 – 40°C (32 - 104°F)
Noise Level	Maximum 32 db. Tahoma LE has temperature sensor to regulate fan speed, actual noise level may be much lower

Figure 3 - 4 show the front and back panels of the Tahoma LE-4.

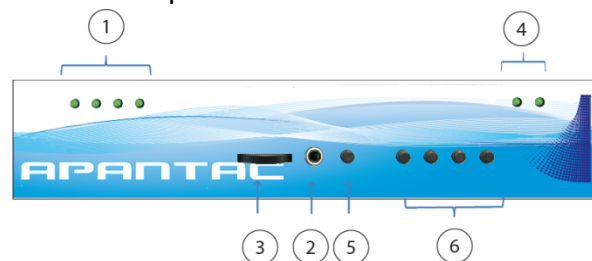

Figure 3: Tahoma LE-4 front panel view

1. Signal presence LED
2. Audio phone jack output
3. Volume adjustment
4. Power supply status
5. Paging mode
6. Buttons to recall preset

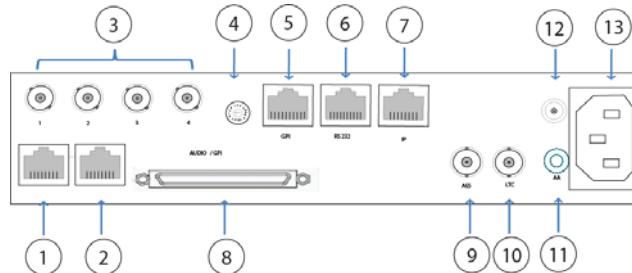
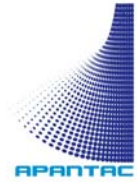

Figure 4: Tahoma LE-4 rear panel view

1. RJ45: Reserved for future use
 2. RJ45: For DVI/HDMI/VGA output with built-in extenders up to 2048x1080 @115ft (35 meters) with optional active receiver. Passive receivers supports up to 35 feet.
 3. BNCs: Input for video (auto-detect PAL/NTSC, HD/SD-SDI, and 3G HD-SDI)
 4. Rotary Switch: reserved for future use
 5. RJ50: GPI/O for control, alarm and tally
 6. RJ45: RS232 serial
 7. RJ45: IP control
 8. SCSI connector: for discrete audio and GPI/O
 9. BNC: Line level AES audio monitor output*
 10. BNC: LTC input to sync on screen clocks
 11. Phone Jack: Line level stereo audio monitor output*
 12. Redundant DC Power Supply 12V
 13. AC Power – 90 to 250 50/60Hz
- *Audio monitoring is available in line level in stereo and AES



Tahoma LE-8 / LE-16

Table 13: Tahoma LE-8 / LE-16 Physical Specifications

Size	H: 1.75 in (4.45 cm, 1RU)), W: 18 in (21.6 cm), D: 13 in (33 cm)
Rack installation	Standard 19-inch equipment rack.
Weight	12 lbs. (2.8kg)
Power	90/250 VAC, 60/50Hz, 100 W, internal auto switchable
Noise Level	Maximum 38dB. Tahoma LE has temperature sensor to regulate fan speed, actual noise level may be much lower

Figure 5 - 6 shows the front and back panels of the Tahoma LE-16.

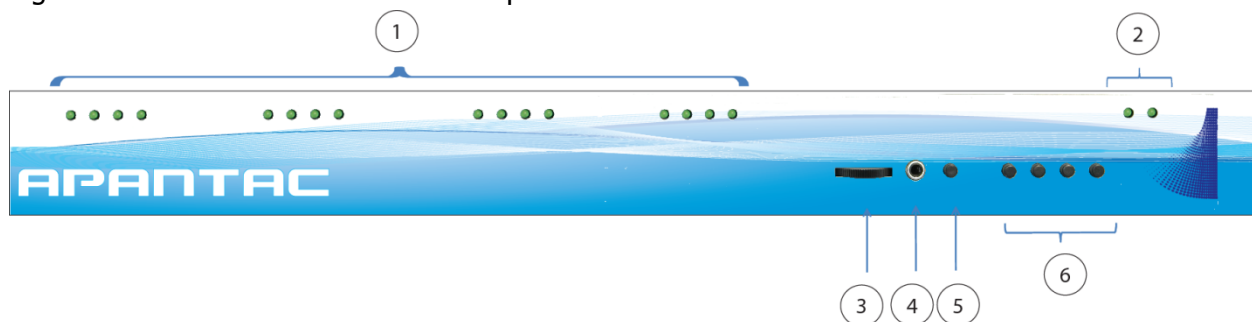

Figure 5: Tahoma LE-16 front panel view

Front Panel indicators, connectors and buttons are:

1. Signal presence LED
2. Power supply status
3. Audio volume adjustment
4. Audio phone jack output
5. Paging mode
6. Buttons to recall presets

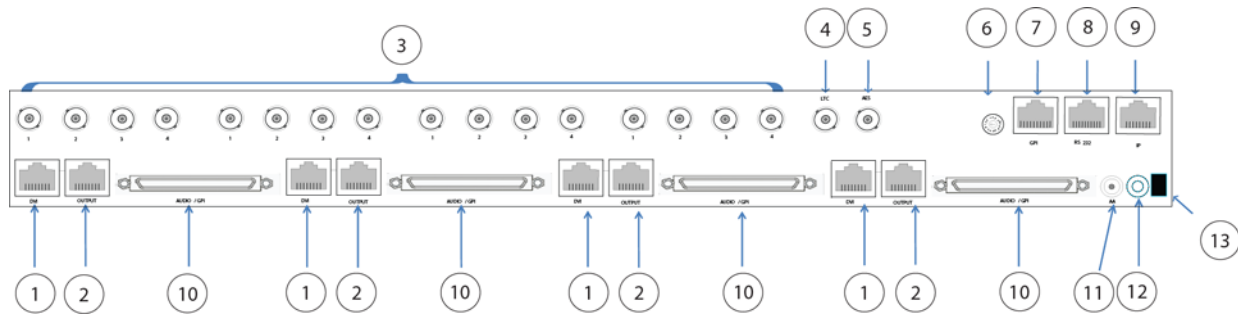
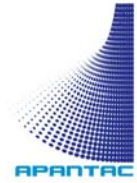

Figure 6: Tahoma LE-16 rear panel view

Rear Panel indicators, connectors and buttons are:

1. RJ45: Reserved for future use
 2. RJ45: For DVI/HDMI/VGA output with built-in extenders up to 2048x1080 @115ft (35 meters) with optional active receiver. Passive receivers supports up to 35 feet.
 3. BNCs: Input for video (auto-detect PAL/NTSC, HD/SD-SDI, and 3G HD-SDI)
 4. BNC: LTC input to sync on screen clocks
 5. BNC: Line level AES audio monitor output*
 6. Rotary Switch: reserved for future use
 7. RJ50: GPI/O for control, alarm and tally
 8. RJ45: RS232 serial
 9. RJ45: IP control
 10. SCSI connector: for discrete audio and GPI/O
 11. Phone Jack: Line level stereo audio monitor output*
 12. Redundant DC Power 12V
 13. AC Power – 90 to 250 50/60Hz
- *Audio monitoring is available in line level in stereo and AES



Tahoma LE-20 / LE-24 / LE-28 / LE-32

Table 14: Tahoma LE-20 / LE-24 / LE-28 / LE-32 Physical Specifications

Size	H: 3.50 in (8.9 cm, 2RU), W: 18 in (21.6 cm), D: 13 in (33 cm)
Rack installation	Standard 19-inch equipment rack.
Weight	25 lbs. (2.8kg)
Power	90/250 VAC, 60/50Hz, 200 W, internal auto switchable
Noise Level	Maximum 41dB. Tahoma LE has temperature sensor to regulate fan speed, actual noise level may be much lower

Figure 7 - 8 shows the front and back panels of the Tahoma LE-32.

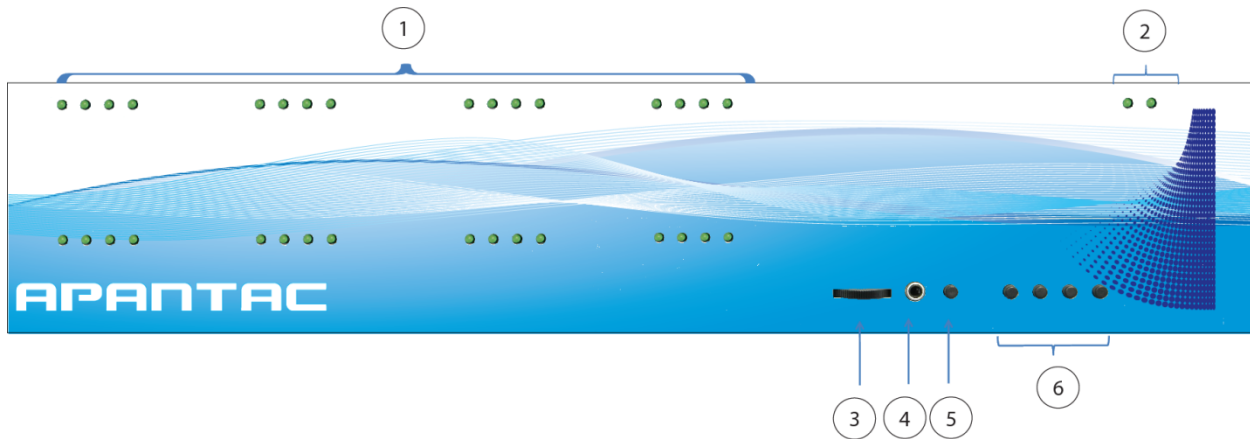

Figure 7: Tahoma LE-32 front panel view

1. Signal presence LED
2. Power supply status
3. Audio volume adjustment
4. Audio phone jack output
5. Paging mode
6. Buttons to recall presets

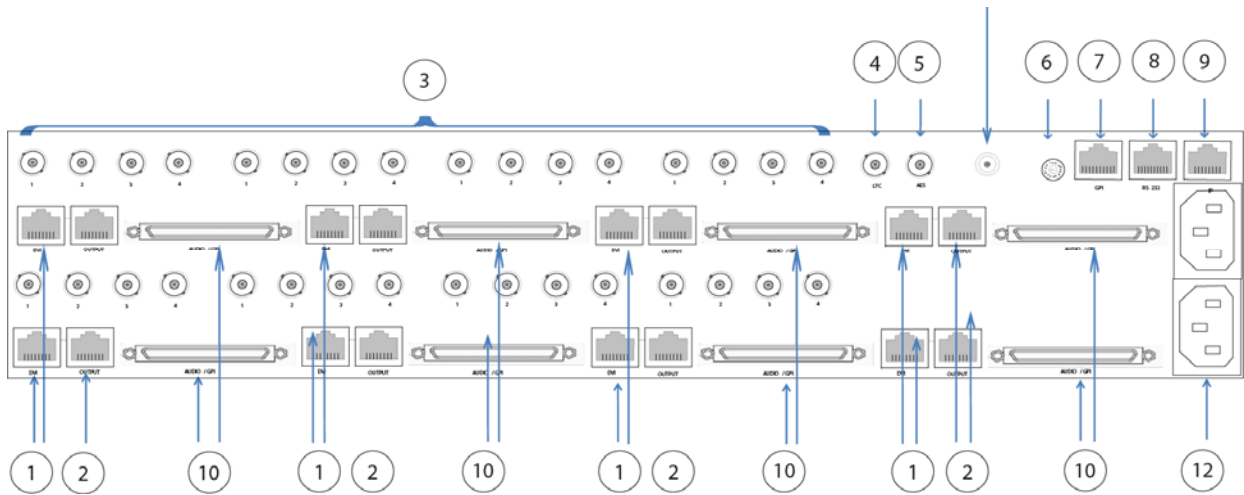
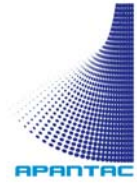

Figure 8: Tahoma LE-32 rear panel view

Rear Panel indicators, connectors and buttons are:

1. RJ45: Reserved for future use
2. RJ45: For DVI/HDMI/VGA output with built-in extenders up to 2048x1080 @115ft (35 meters) with optional active receiver. Passive receivers supports up to 35 feet.
3. BNCs: Input for video (auto-detect PAL/NTSC, HD/SD-SDI, and 3G HD-SDI)
4. BNC: LTC input to sync on screen clocks
5. BNC: Line level AES audio monitor output*
6. Rotary Switch: Reserved for future use
7. RJ50: GPI/O for control, alarm and tally
8. RJ45: RS232 serial
9. RJ45: IP control
10. SCSI connector: for discrete audio and GPI/O
11. Phone Jack: Line level stereo audio monitor output*

*Audio monitoring is available in line level in stereo and AES



Tahoma LI-4 / LI-8

Table 15: Tahoma LI-4 / LI-8 Physical Specifications

Size	H: 1.75 in (4.45 cm, 1RU), W: 18 in (21.6 cm), D: 13 in (33 cm)
Rack installation	Standard 19-inch equipment rack.
Weight	12 lbs. (2.8kg)
Power	90/250 VAC, 60/50Hz, 100 W, internal auto switchable
Noise Level	Maximum 38dB. Tahoma LE has temperature sensor to regulate fan speed, actual noise level may be much lower

Figure 9 - 10 shows the front and back panels of the Tahoma LI-4 / LI-8.

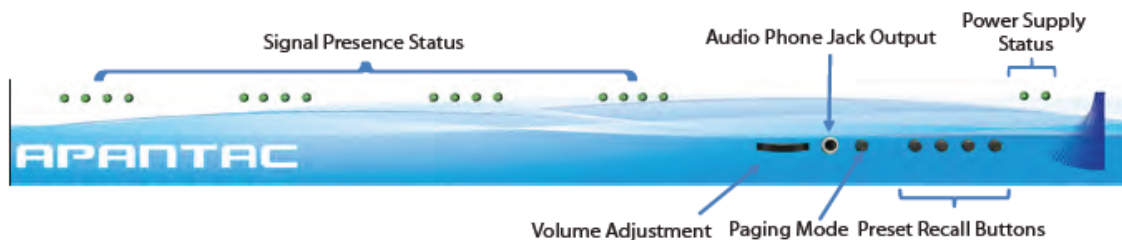

Figure 9: Tahoma LI-4 / LI-8 front panel view

Front Panel indicators, connectors and buttons are:

1. Signal presence LED
2. Power supply status
3. Audio volume adjustment
4. Audio phone jack output
5. Paging mode
6. Buttons to recall presets

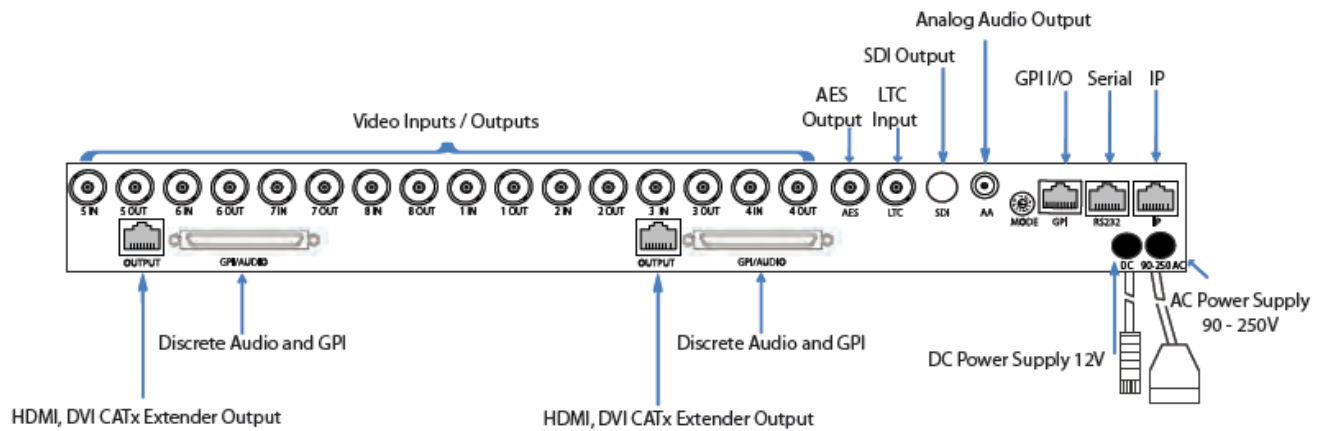
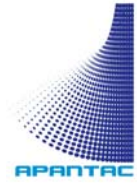

Figure 10: Tahoma LI-4 / LI-8 rear panel view

Rear Panel indicators, connectors and buttons are:

1. RJ45: For DVI/HDMI/VGA output with built-in extenders up to 2048x1080 @115ft (35 meters) with optional active receiver. Passive receivers supports up to 35 feet.
2. BNCs: Input for video (auto-detect PAL/NTSC, HD/SD-SDI, and 3G HD-SDI)
3. BNC: LTC input to sync on screen clocks
4. BNC: Line level AES audio monitor output*
5. Rotary Switch: Reserved for future use
6. RJ50: GPI/O for control, alarm and tally
7. RJ45: RS232 serial
8. RJ45: IP control
9. SCSI connector: for discrete audio and GPI/O
10. Phone Jack: Line level stereo audio monitor output*
11. Redundant DC Power 12V
12. AC Power – 90 to 250 50/60Hz

*Audio monitoring is available in line level in stereo and AES



Tahoma LI-12 / LI-16

Table 16: Tahoma LI-12 / LI-16 Physical Specifications

Size	H: 3.50 in (8.9 cm, 2RU), W: 18 in (21.6 cm), D: 13 in (33 cm)
Rack installation	Standard 19-inch equipment rack.
Weight	25 lbs. (2.8kg)
Power	90/250 VAC, 60/50Hz, 200 W, internal auto switchable
Noise Level	Maximum 41dB. Tahoma LE has temperature sensor to regulate fan speed, actual noise level may be much lower

Figure 11 – 12 shows the front and back panels of the Tahoma LI-12 / LI-16

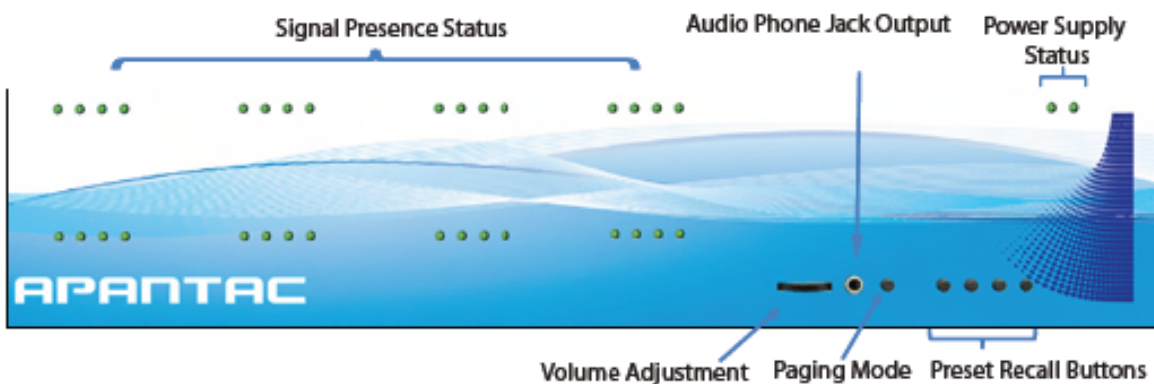

Figure 11: Tahoma LI-12 / LI-16 front panel view

1. Signal presence LED
2. Power supply status
3. Audio volume adjustment
4. Audio phone jack output
5. Paging mode
6. Buttons to recall presets

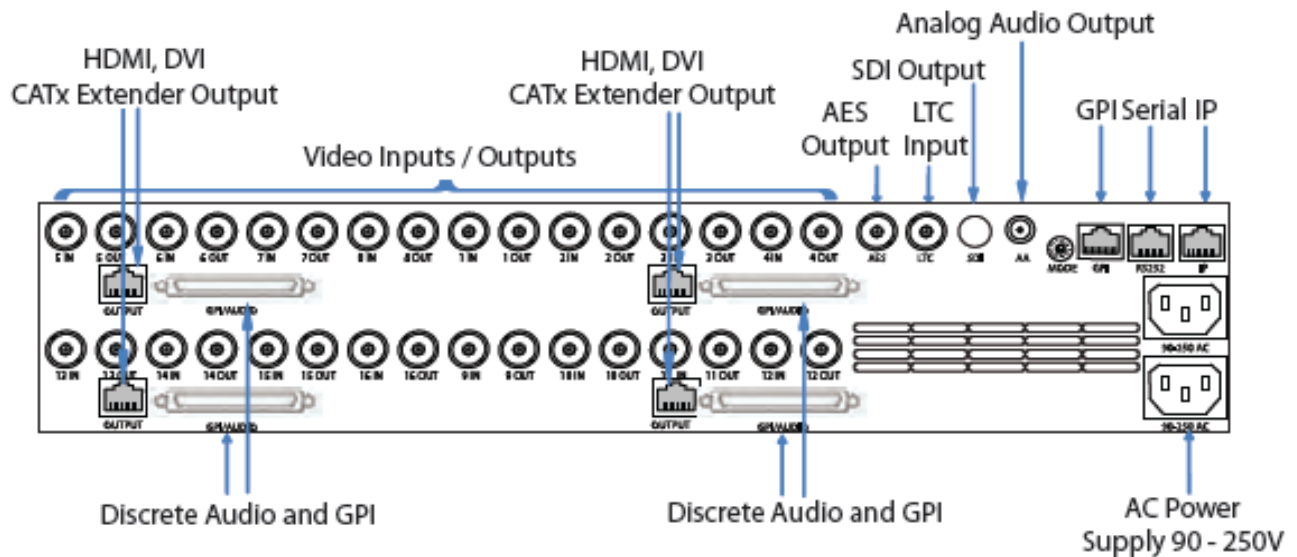
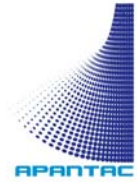

Figure 12: Tahoma LI-12 / LI-16 rear panel view

Rear Panel indicators, connectors and buttons are:

1. RJ45: For DVI/HDMI/VGA output with built-in extenders up to 2048x1080 @115ft (35 meters) with optional active receiver. Passive receivers supports up to 35 feet.
2. BNCs: Input for video (auto-detect PAL/NTSC, HD/SD-SDI, and 3G HD-SDI)
3. BNC: LTC input to sync on screen clocks
4. BNC: Line level AES audio monitor output*
5. Rotary Switch: Reserve for future use
6. RJ50: GPI/O for control, alarm and tally
7. RJ45: RS232 serial
8. RJ45: IP control
9. SCSI connector: for discrete audio and GPI/O
10. Phone Jack: Line level stereo audio monitor output*

*Audio monitoring is available in line level in stereo and AES



Tahoma LX-4 / LX-8 / LX12 / LX-16

Table 17: Tahoma LX-4 / LX-8 / LX12 / LX-16 Physical Specifications

Size	H: 1.75 in (4.45 cm, 1RU), W: 18 in (21.6 cm), D: 13 in (33 cm)
Rack installation	Standard 19-inch equipment rack.
Weight	12 lbs. (2.8kg)
Power	90/250 VAC, 60/50Hz, 100 W, internal auto switchable
Noise Level	Maximum 38dB. Tahoma LE has temperature sensor to regulate fan speed, actual noise level may be much lower

Figure 13 - 14 shows the front and back panels of the Tahoma LX-4 / LX-8 / LX12 / LX-16.

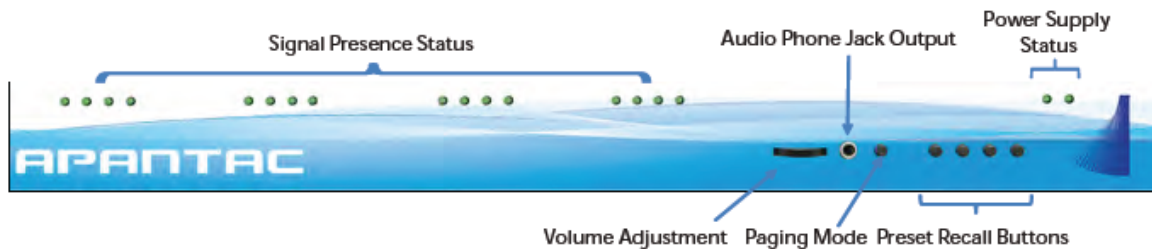

Figure 13: Tahoma LX-4 / LX-8 / LX12 / LX-16 front panel view

Front Panel indicators, connectors and buttons are:

1. Signal presence LED
2. Power supply status
3. Audio volume adjustment
4. Audio phone jack output
5. Paging mode
6. Buttons to recall presets

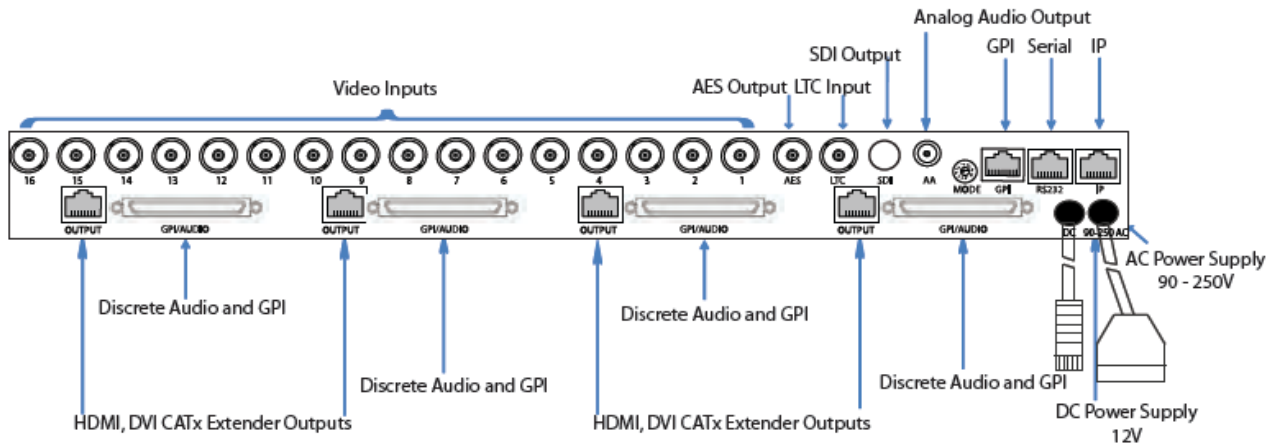
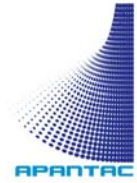

Figure 14: Tahoma LX-4 / LX-8 / LX12 / LX-16 rear panel view

Rear Panel indicators, connectors and buttons are:

1. RJ45: For DVI/HDMI/VGA output with built-in extenders up to 2048x1080 @115ft (35 meters) with optional active receiver. Passive receivers supports up to 35 feet.
2. BNCs: Input for video (auto-detect PAL/NTSC, HD/SD-SDI, and 3G HD-SDI)
3. BNC: LTC input to sync on screen clocks
4. BNC: Line level AES audio monitor output*
5. Rotary Switch: reserved for future use
6. RJ50: GPI/O for control, alarm and tally
7. RJ45: RS232 serial
8. RJ45: IP control
9. SCSI connector: for discrete audio and GPI/O
10. Phone Jack: Line level stereo audio monitor output*
11. Redundant DC Power 12V
12. AC Power – 90 to 250 50/60Hz

*Audio monitoring is available in line level in stereo and AES



Tahoma LX-16-32 / LX-20 / LX-24 / LX-28 / LX-32

Table 18: Tahoma LX-16-32 / LX-20 / LX-24 / LX-28 / LX-32 Physical Specifications

Size	H: 5.25 in (13.34 cm, 3RU), W: 18 in (21.6 cm), D: 13 in (33 cm)
Rack installation	Standard 19-inch equipment rack.
Weight	25 lbs. (2.8kg)
Power	90/250 VAC, 60/50Hz, 200 W, internal auto switchable
Noise Level	Maximum 41dB. Tahoma LE has temperature sensor to regulate fan speed, actual noise level may be much lower

Figure 15 - 16 shows the front and back panels of the Tahoma LX-32.

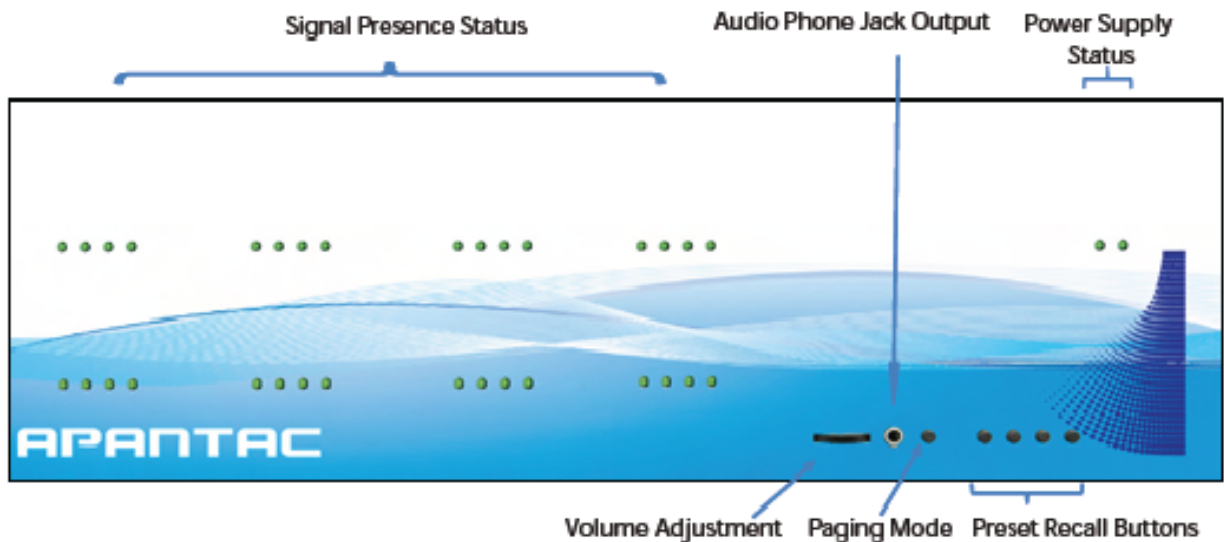

Figure 15: Tahoma LX-32 front panel view

1. Signal presence LED
2. Power supply status
3. Audio volume adjustment
4. Audio phone jack output
5. Paging mode
6. Buttons to recall presets

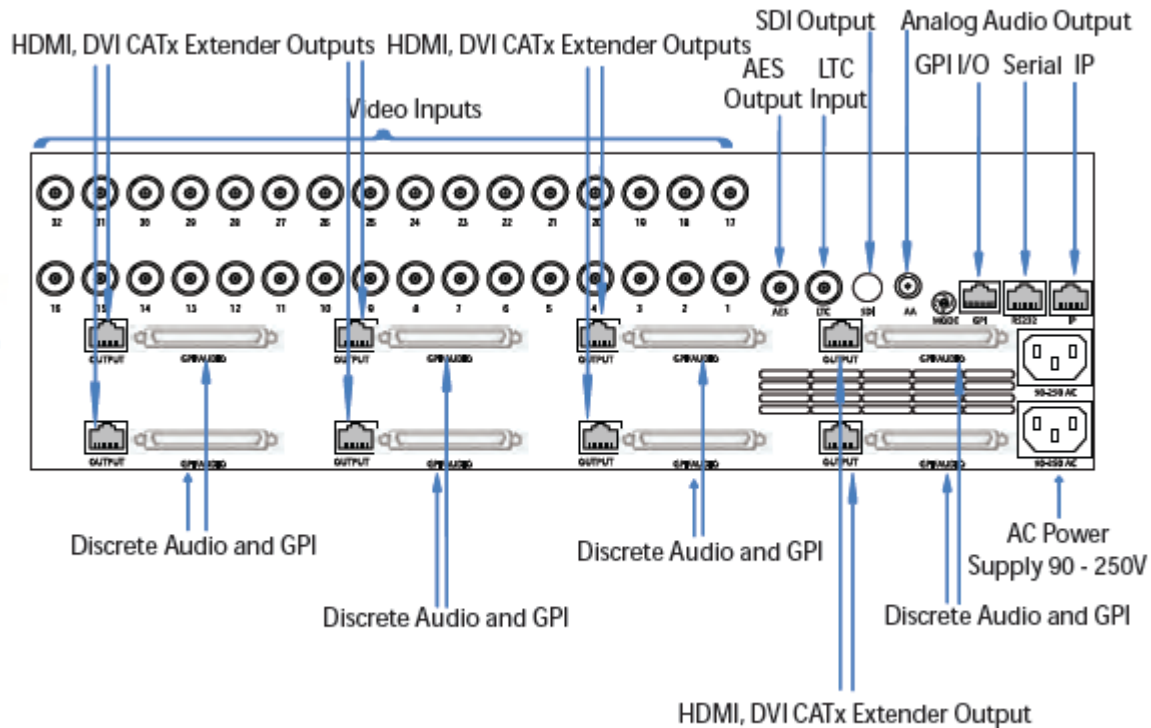
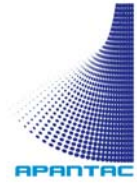

Figure 16: Tahoma LX-32 rear panel view

Rear Panel indicators, connectors and buttons are:

1. RJ45: For DVI/HDMI/VGA output with built-in extenders up to 2048x1080 @115ft (35 meters) with optional active receiver. Passive receivers supports up to 35 feet.
2. BNCs: Input for video (auto-detect PAL/NTSC, HD/SD-SDI, and 3G HD-SDI)
3. BNC: LTC input to sync on screen clocks
4. BNC: Line level AES audio monitor output*
5. Rotary Switch: Reserved for future use
6. RJ50: GPI/O for control, alarm and tally
7. RJ45: RS232 serial
8. RJ45: IP control
9. SCSI connector: for discrete audio and GPI/O
10. Phone Jack: Line level stereo audio monitor output*

*Audio monitoring is available in line level in stereo and AES



Tahoma DE-4 / DE-8

Table 19: Tahoma DE-4 / DE-8 Physical Specifications

Size	H: 1.75 in (4.45 cm, 1RU)), W: 18 in (21.6 cm), D: 13 in (33 cm)
Rack installation	Standard 19-inch equipment rack.
Weight	12 lbs. (2.8kg)
Power	90/250 VAC, 60/50Hz, 100 W, internal auto switchable
Noise Level	Maximum 38dB. Tahoma LE has temperature sensor to regulate fan speed, actual noise level may be much lower

Figure 17 - 18 shows the front and back panels of the Tahoma DE-4 / DE-8.

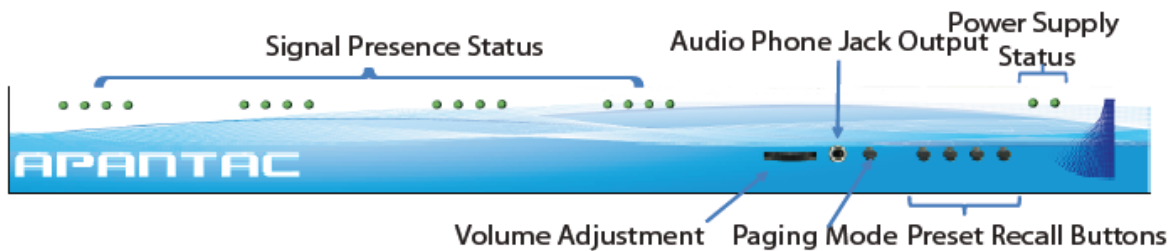

Figure 17: Tahoma DE-4 / DE-8 front panel view

Front Panel indicators, connectors and buttons are:

1. Signal presence LED
2. Power supply status
3. Audio volume adjustment
4. Audio phone jack output
5. Paging mode
6. Buttons to recall presets

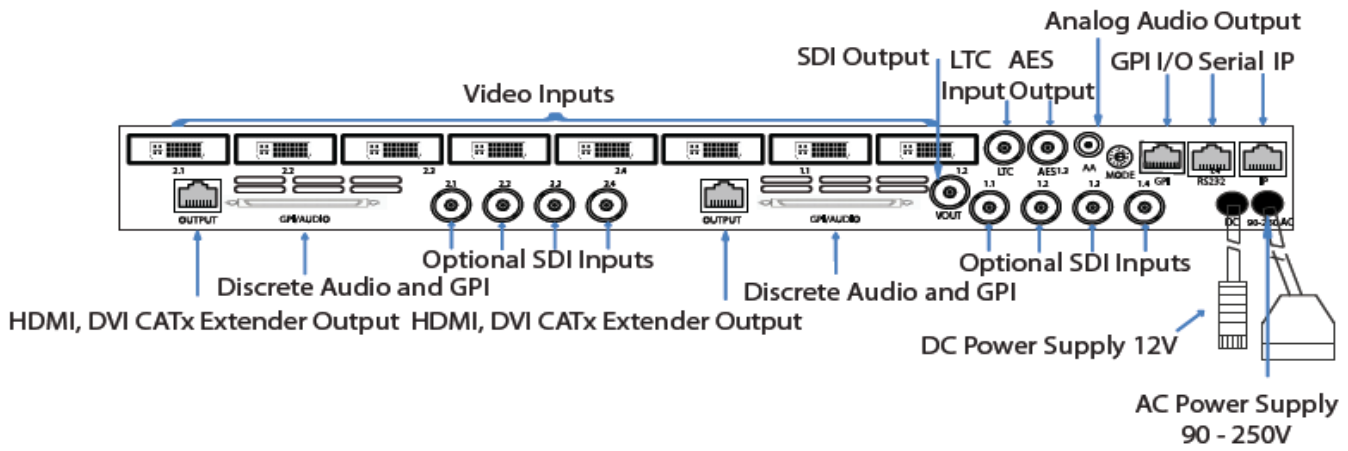
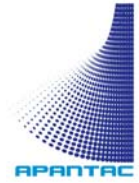

Figure 18: Tahoma DE-4 / DE-8 rear panel view

Rear Panel indicators, connectors and buttons are:

1. RJ45: For DVI/HDMI/VGA output with built-in extenders up to 2048x1080 @115ft (35 meters) with optional active receiver. Passive receivers supports up to 35 feet.
2. DVI-I's: Input for video (auto-detect HDMI (with adapter), DVI, VGA (with adapter), composite (with breakout), component (with breakout), YC (with breakout))
3. BNC's: HD/SD-SDI, and 3G HD-SDI
4. BNC: LTC input to sync on screen clocks
5. BNC: Line level AES audio monitor output*
6. Rotary Switch: Reserved for future use
7. RJ50: GPI/O for control, alarm and tally
8. RJ45: RS232 serial
9. RJ45: IP control
10. SCSI connector: for discrete audio and GPI/O
11. Phone Jack: Line level stereo audio monitor output*
12. Redundant DC Power 12V
13. AC Power – 90 to 250 50/60Hz

*Audio monitoring is available in line level in stereo and AES



Tahoma DE-12 / DE-16

DE-12 / DE-16 Multiviewers are still under development. Information coming soon

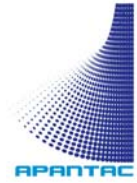

PRODUCT CONTENTS - "WHAT'S IN THE BOX"

Table-20: What's in the box – LE Series

	Accessories / Models	LE-4x	LE-8x	LE-12x	LE-16x	LE-20x	LE-24x	LE-28x	LE-32x
1	Hardware	1	1	1	1	1	1	1	1
2	Power Cord (North America Only)	1	1	1	1	1	1	1	1
3	Serial Breakout	1	1	1	1	1	1	1	1
4	Rack mount	1 set of Rack Ears, 1 x Blank Panel	1 set of Rack Ears	1 set of Rack Ears	1 set of Rack Ears	1 set of Rack Ears	1 set of Rack Ears	1 set of Rack Ears	1 set of Rack Ears
5	CPM GPI Breakout	1	1	1	1	1	1	1	1
6	VPM GPI Breakout	1	2	3	4	5	6	7	8
7	CD	1	1	1	1	1	1	1	1

*CPM = Control Process Module, *VPM = Video Processing Module

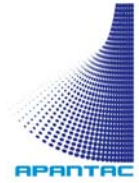

Table 21: What's in the box – LI Series

	Accessories / Models	LI-4x	LI-8x	LI-12x	LI-16x
1	Hardware	1	1	1	1
2	Power Cord (North America Only)	1	1	1	1
3	Serial Breakout	1	1	1	1
4	Rack mount	1 set of Rack Ears, 1 x Blank Panel	1 set of Rack Ears	1 set of Rack Ears	1 set of Rack Ears
5	CPM GPI Breakout	1	1	1	1
6	VPM GPI Breakout	1	2	3	4
7	CD	1	1	1	1

*CPM = Control Process Module, *VPM = Video Processing Module

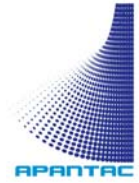

Table 22: What's in the box – LX Series

	Accessories / Models	LX-4x	LX-8x	LX-12x	LX-16x	LX-20x	LX-24x	LX-28x	LX-32x
1	Hardware	1	1	1	1	1	1	1	1
2	Power Cord (North America Only)	1	1	1	1	1	1	1	1
3	Serial Breakout	1	1	1	1	1	1	1	1
4	Rack mount	1Rack Ears, 1 x Blank Panel	11set of Rack Ears	1 set of Rack Ears	1 set of Rack Ears	1 set of Rack Ears	1 set of Rack Ears	1 set of Rack Ears	1 set of Rack Ears
5	CPM GPI Breakout	1	1	1	1	1	1	1	1
6	VPM GPI Breakout	1	2	3	4	5	6	7	8
7	CD	1	1	1	1	1	1	1	1

*CPM = Control Process Module, *VPM = Video Processing Module

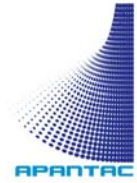

Table 23: What's in the box – DE Series

Accessories / Models		DE-4	DE-8
1	Hardware	1	1
2	Power Cord (North America Only)	1	1
3	Serial Breakout	1	1
4	Rack mount	1 set of Rack Ears	1 set of Rack Ears
5	CPM GPI Breakout	1	1
6	VPM GPI Breakout	1	2
7	DVI-VGA Adapter	4	8
8	CD	1	1

*CPM = Control Process Module, *VPM = Video Processing Module

OPTIONAL ACCESSORIES

Table 24: Optional Accessories

Accessories		Description
1	Unbalanced Analog	Breakout Box with 16 BNC inputs
2	Audio Breakout Unbalanced AES Audio	Breakout Box with 8 BNC inputs
3	Breakout Balance Analog Audio	Breakout Box with 16 XLR inputs
4	Breakout Balance AES Audio	Breakout Box with 8 BNC inputs
5	Breakout RS232-RS422 Converter	Serial Tally Interface
6	Redundant Power Supply	DC Redundant Power Supply
7	RJ45 to VGA	RJ45 VGA receiver

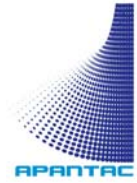

Overview of TAHOMA Platform Models

TAHOMA LE MODELS

Analog composite video inputs

- LE-4CV: Accepts 4 analog composite video as inputs. Auto-detect NTSC or PAL
- LE-8CV: Accepts 8 analog composite video as inputs. Auto-detect NTSC or PAL
- LE-12CV: Accepts 12 analog composite video as inputs. Auto-detect NTSC or PAL
- LE-16CV: Accepts 16 analog composite video as inputs. Auto-detect NTSC or PAL
- LE-20CV: Accepts 20 analog composite video as inputs. Auto-detect NTSC or PAL
- LE-24CV: Accepts 24 analog composite video as inputs. Auto-detect NTSC or PAL
- LE-28CV: Accepts 28 analog composite video as inputs. Auto-detect NTSC or PAL
- LE-32CV: Accepts 32 analog composite video as inputs. Auto-detect NTSC or PAL

SD-SDI/analog composite video inputs

- LE-4SD: Accepts 4 SD-SDI or analog composite video as inputs. Auto-detects between analog and SD-SDI in 50/60Hz
- LE-8SD: Accepts 8 SD-SDI or analog composite video as inputs. Auto-detects between analog and SD-SDI in 50/60Hz
- LE-12SD: Accepts 12 SD-SDI or analog composite video as inputs. Auto-detects between analog and SD-SDI in 50/60Hz
- LE-16SD: Accepts 16 SD-SDI or analog composite video as inputs. Auto-detects between analog and SD-SDI in 50/60Hz
- LE-20SD: Accepts 20 SD-SDI or analog composite video as inputs. Auto-detects between analog and SD-SDI in 50/60Hz
- LE-24SD: Accepts 24 SD-SDI or analog composite video as inputs. Auto-detects between analog and SD-SDI in 50/60Hz
- LE-28SD: Accepts 28 SD-SDI or analog composite video as inputs. Auto-detects between analog and SD-SDI in 50/60Hz
- LE-32SD: Accepts 32 SD-SDI or analog composite video as inputs. Auto-detects between analog and SD-SDI in 50/60Hz

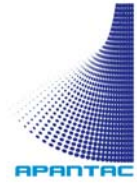

HD/SD-SDI/analog composite video inputs

- LE-4HD: Accepts 4 HD/SD-SDI or analog composite video as inputs. Auto-detects between analog and HD/SD-SDI in 24/50/60Hz
- LE-8HD: Accepts 8 HD/SD-SDI or analog composite video as inputs. Auto-detects between analog and HD/SD-SDI in 24/50/60Hz
- LE-12HD: Accepts 12 HD/SD-SDI or analog composite video as inputs. Auto-detects between analog and HD/SD-SDI in 24/50/60Hz
- LE-16HD: Accepts 16 HD/SD-SDI or analog composite video as inputs. Auto-detects between analog and HD/SD-SDI in 24/50/60Hz
- LE-20HD: Accepts 20 HD/SD-SDI or analog composite video as inputs. Auto-detects between analog and HD/SD-SDI in 24/50/60Hz
- LE-24HD: Accepts 24 HD/SD-SDI or analog composite video as inputs. Auto-detects between analog and HD/SD-SDI in 24/50/60Hz
- LE-28HD: Accepts 28 HD/SD-SDI or analog composite video as inputs. Auto-detects between analog and HD/SD-SDI in 24/50/60Hz
- LE-32HD: Accepts 32 HD/SD-SDI or analog composite video as inputs. Auto-detects between analog and HD/SD-SDI in 24/50/60Hz

TAHOMA LI MODELS

Analog composite video inputs

- LI-4CV: Accepts 4 analog composite video as inputs with looping output. Auto-detect NTSC or PAL
- LI-8CV: Accepts 8 analog composite video as inputs with looping output. Auto-detect NTSC or PAL
- LI-12CV: Accepts 12 analog composite video as inputs with looping output. Auto-detect NTSC or PAL
- LI-16CV: Accepts 16 analog composite video as inputs with looping output. Auto-detect NTSC or PAL

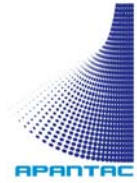

SD-SDI

- LI-4SD: Accepts 4 SD-SDI or analog composite video as inputs with looping output. Auto-detects between analog and SD-SDI in 50/60Hz
- LI-8SD: Accepts 8 SD-SDI or analog composite video as inputs with looping output. Auto-detects between analog and SD-SDI in 50/60Hz
- LI-12SD: Accepts 12 SD-SDI or analog composite video as inputs with looping output. Auto-detects between analog and SD-SDI in 50/60Hz
- LI-16SD: Accepts 16 SD-SDI or analog composite video as inputs with looping output. Auto-detects between analog and SD-SDI in 50/60Hz

HD/SD-SDI

- LI-4HD: Accepts 4 HD/SD-SDI or analog composite video as inputs with looping output. Auto-detects between analog and HD/SD-SDI in 24/50/60Hz
- LI-8HD: Accepts 8 HD/SD-SDI or analog composite video as inputs with looping output. Auto-detects between analog and HD/SD-SDI in 24/50/60Hz
- LI-12HD: Accepts 12 HD/SD-SDI or analog composite video as inputs with looping output. Auto-detects between analog and HD/SD-SDI in 24/50/60Hz
- LI-16HD: Accepts 16 HD/SD-SDI or analog composite video as inputs with looping output. Auto-detects between analog and HD/SD-SDI in 24/50/60Hz

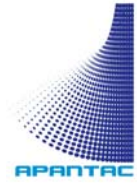

TAHOMA LX MODELS

SD-SDI

- LX-4SD: Accepts 16 SD-SDI inputs that can be displayed on 4 windows. Auto-detects between analog and SD-SDI in 50/60Hz
- LX-8SD: Accepts 16 SD-SDI inputs that can be displayed on 8 windows. Auto-detects between analog and SD-SDI in 50/60Hz
- LX-12SD: Accepts 16 SD-SDI inputs that can be displayed on 12 windows. Auto-detects between analog and SD-SDI in 50/60Hz
- LX-16SD: Accepts 16 SD-SDI inputs can be displayed on 16 windows. Auto-detects between analog and SD-SDI in 50/60Hz
- LX-20SD: Accepts 32 SD-SDI inputs can be displayed on 20 windows. Auto-detects between analog and SD-SDI in 50/60Hz
- LX-24SD: Accepts 32 SD-SDI inputs can be displayed on 24 windows. Auto-detects between analog and SD-SDI in 50/60Hz
- LX-28SD: Accepts 32 SD-SDI inputs can be displayed on 28 windows. Auto-detects between analog and SD-SDI in 50/60Hz
- LX-32SD: Accepts 32 SD-SDI inputs can be displayed on 32 windows. Auto-detects between analog and SD-SDI in 50/60Hz

HD/SD-SDI

- LX-4HD: Accepts 16 HD/SD-SDI inputs that can be displayed on 4 windows Auto-detects between analog and HD/SD-SDI in 24/50/60Hz
- LX-8HD: Accepts 16 HD/SD-SDI inputs that can be displayed on 8 windows. Auto-detects between analog and HD/SD-SDI in 24/50/60Hz
- LX-12HD: Accepts 16 HD/SD-SDI inputs that can be displayed on 12 windows. Auto-detects between analog and HD/SD-SDI in 24/50/60Hz
- LX-16HD: Accepts 16 HD/SD-SDI inputs can be displayed on 16 windows. Auto-detects between analog and HD/SD-SDI in 24/50/60Hz
- LX-20HD: Accepts 32 HD/SD-SDI inputs can be displayed on 20 windows. Auto-detects between analog and HD/SD-SDI in 24/50/60Hz
- LX-24HD: Accepts 32 HD/SD-SDI inputs can be displayed on 24 windows. Auto-detects between analog and HD/SD-SDI in 24/50/60Hz
- LX-28HD: Accepts 32 HD/SD-SDI inputs can be displayed on 28 windows. Auto-detects between analog and HD/SD-SDI in 24/50/60Hz

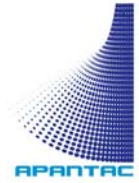

- LX-32HD: Accepts 32 HD/SD-SDI inputs can be displayed on 32 windows. Auto-detects between analog and HD/SD-SDI in 24/50/60Hz

TAHOMA DE MODELS

- DE-4HD: Accepts 4 HDMI/DVI/VGA/YPbPr/YC/HD-SDI/SD-SDI or analog composite video inputs that are be displayed on 4 windows.
- DE-8HD: Accepts 8 HDMI/DVI/VGA/YPbPr/YC/HD-SDI/SD-SDI or analog composite video inputs that are displayed on 8 windows.

INSTALLATION

Mechanical Installation:

Tahoma can be installed in a standard 19" rack using the proper screws and washers (not included). Tahoma modules are shipped with rack ear, blank panels and interconnect (LE/C-4 only). These accessories are not installed to ensure proper shipment. First locate them in the accessories box and then install them.

Note: For proper ventilation, make sure the side panel air vents are not blocked.



Figure 19: Rack mount and airflow for Tahoma LX-16 and LX-32 frames

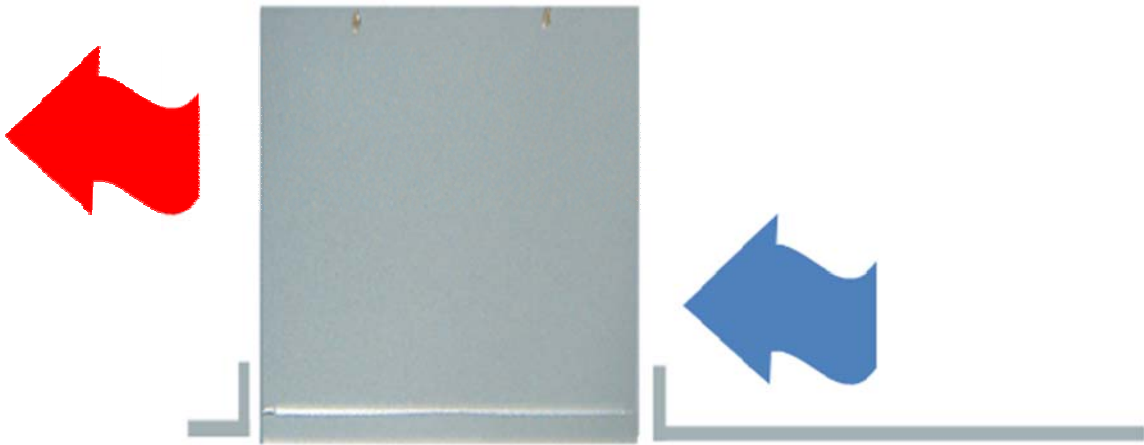

Figure 20: Rack mount and airflow for a single- Tahoma LE/C-4

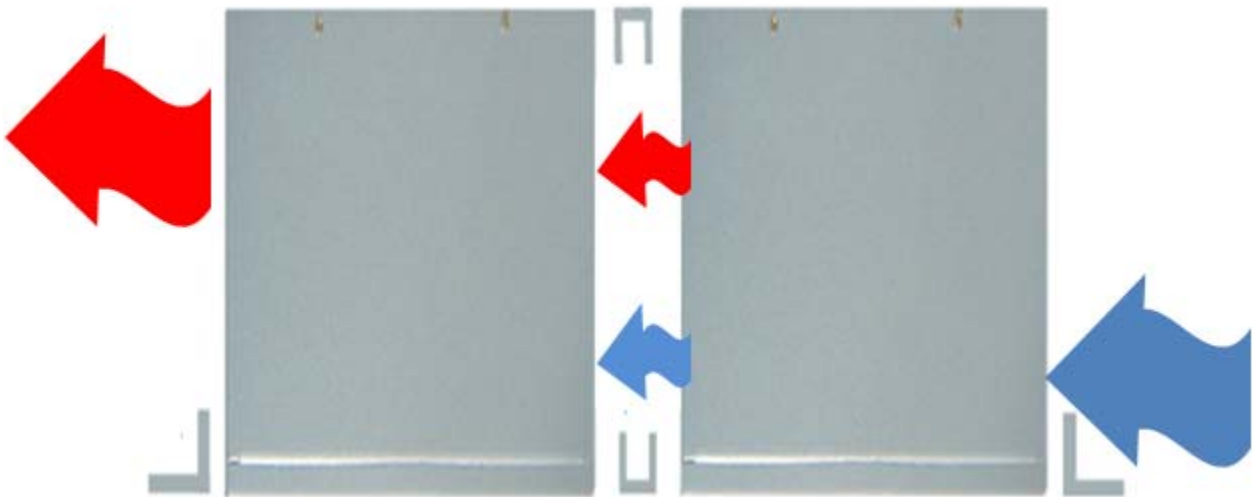
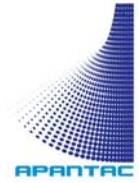

Figure 21: Rack mount and airflow for 2 Tahoma LE/C-4 mounted side by side



Power Connection:

Connect the AC power cord to the rear panel AC receptacle. The Tahoma includes a Universal power supply for 90V to 250V operation.

Dual Power supplies (Optional):

The ½ width 1 RU and 1 RU Tahoma frames come with an optional DC power Supply. This can be purchased during or after the initial purchase. The 2 RU and 3 RU Tahoma frames come standard with the redundant power supply.

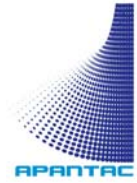

OPERATION

Powering Up

There is no power switch on the Tahoma Multiviewers. Plugging in the power cord will turn on the Multiviewer. Unplugging the power cord will turn off the Multiviewer.

Connection / Indicator / Button Descriptions

- BNC connectors for auto-detect video inputs
- DVI-I connectors for auto-detect high resolution inputs
- 16 embedded audio meters per SDI inputs
- 8 GPI/O on the control board for alarms and recalling presets
- 8 GPI/O on the video processing board for tally, alarm and recalling presets
- 1 Ethernet connection for control and configuration
- 1 RJ45 input for serial connection
- 1 BNC for AES audio output for monitoring
- 1 phone jack on the rear panel for line Level analog audio monitoring
- 1 phone jack on the front panel with volume control for audio monitoring
- 1 BNC for LTC input
- 1 RJ45 for DVI/HDMI(1.2/1.3)/VGA outputs with built in extenders to reach 35 meters (115 feet)
- Rotary switch: Reserved for future use
- Temperature sensor to control fan speed
- LED for input status (present/absent). One LED per input
- 5 buttons on the front panel to recall presets

Optional Hardware

- Unbalanced Analog audio inputs (16 inputs per video processing card)
- Unbalanced AES audio inputs(8 inputs per video processing card)
- Balanced Analog audio inputs (16 inputs per video processing card)
- Balanced AES audio inputs(8 inputs per video processing card)
- Redundant Power Supply
- RJ45 to VGA Receiver

TAHOMA MULTIVIEWER SETUP EXAMPLES

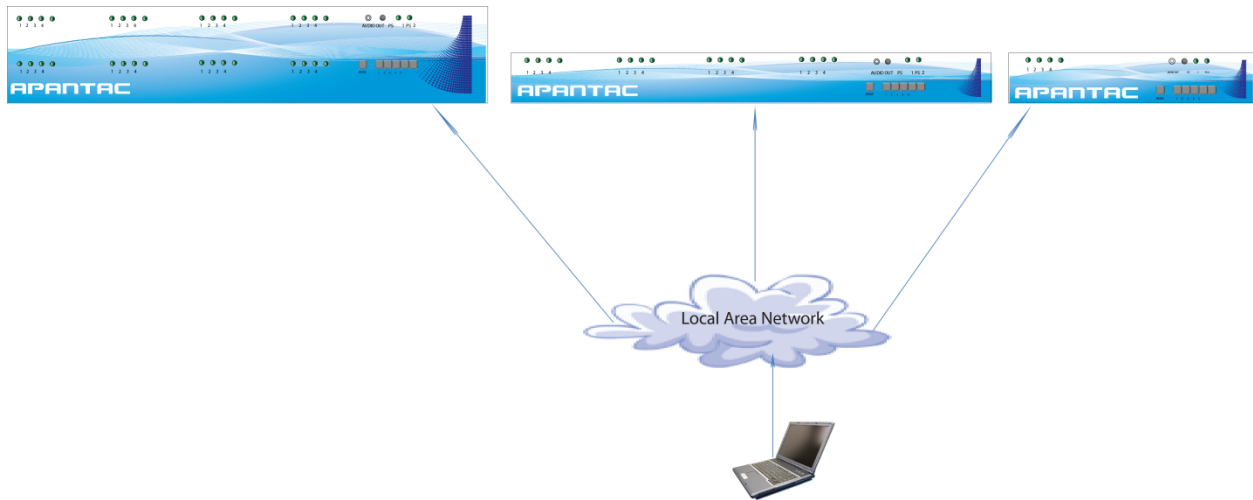

Figure 22: Multiple Tahoma Modules installation with Ethernet connection. Each Tahoma multiviewer has a different IP address.

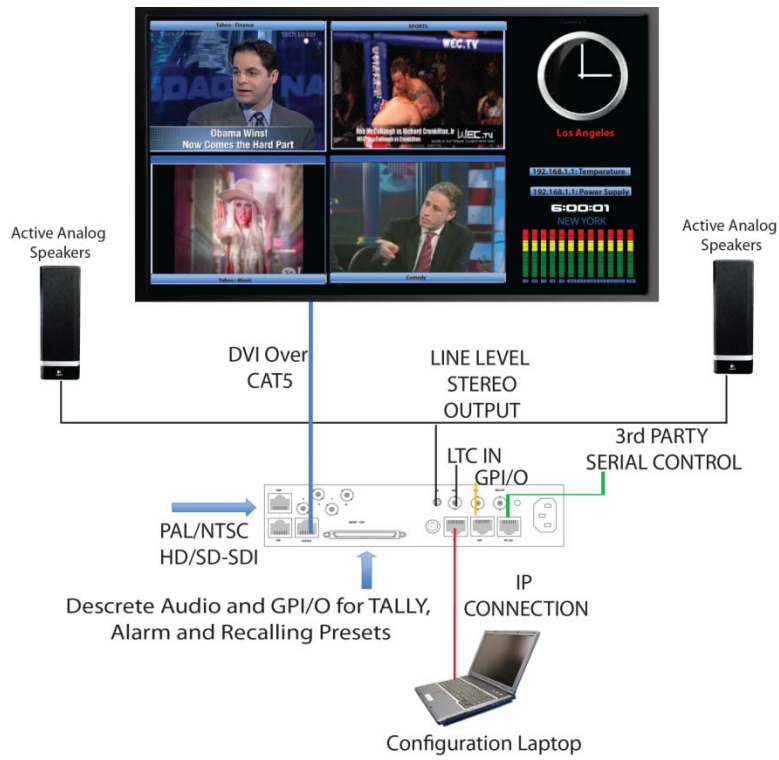

Figure 23: Tahoma setup, displaying analog and digital clocks with standalone labels and audio meters

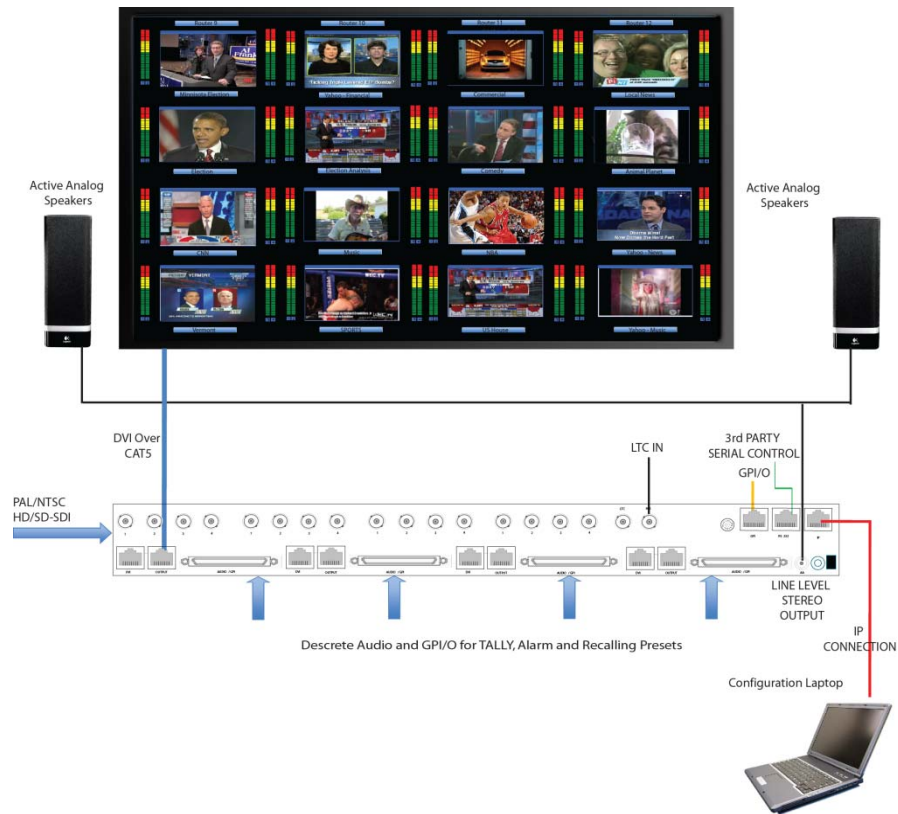

Figure 24: Tahoma LE-16 setup with a single output (16 windows), displaying analog and digital clocks with standalone labels and audio meters

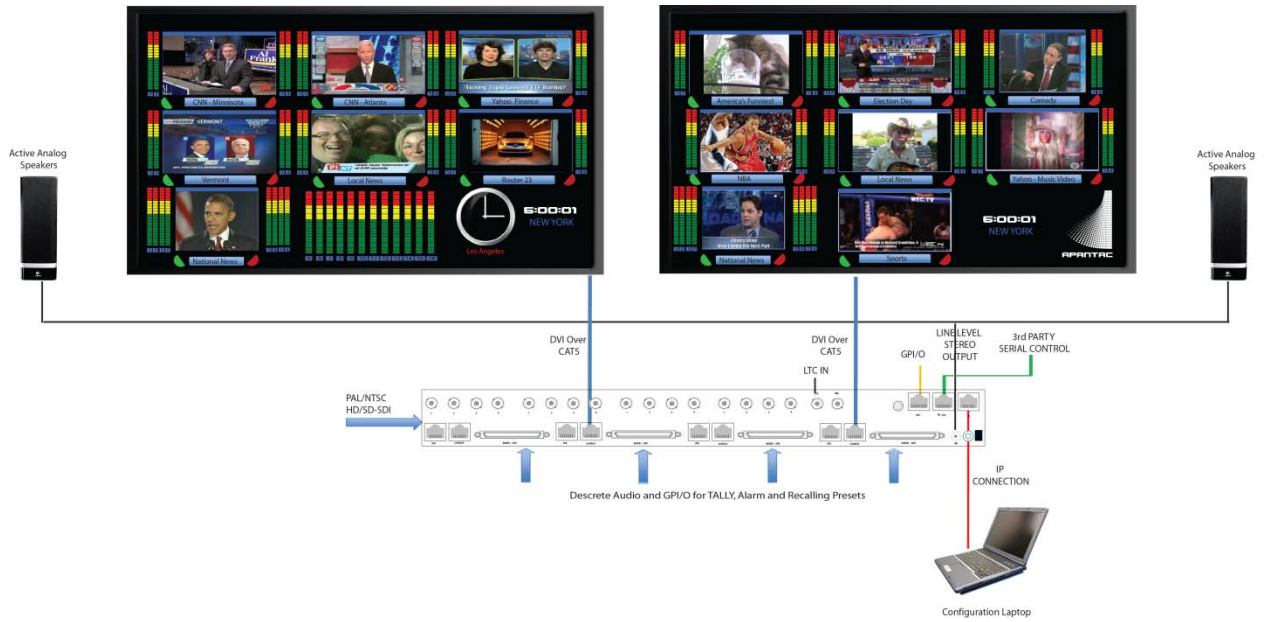

Figure 25: Tahoma LX-16 setup with 2 outputs (8 windows each), displaying analog and digital clocks with standalone labels and audio meters



Figure 26: Tahoma LX-16 setup with 4 outputs (4 windows each), displaying analog and digital clocks with standalone labels, logo and audio meters

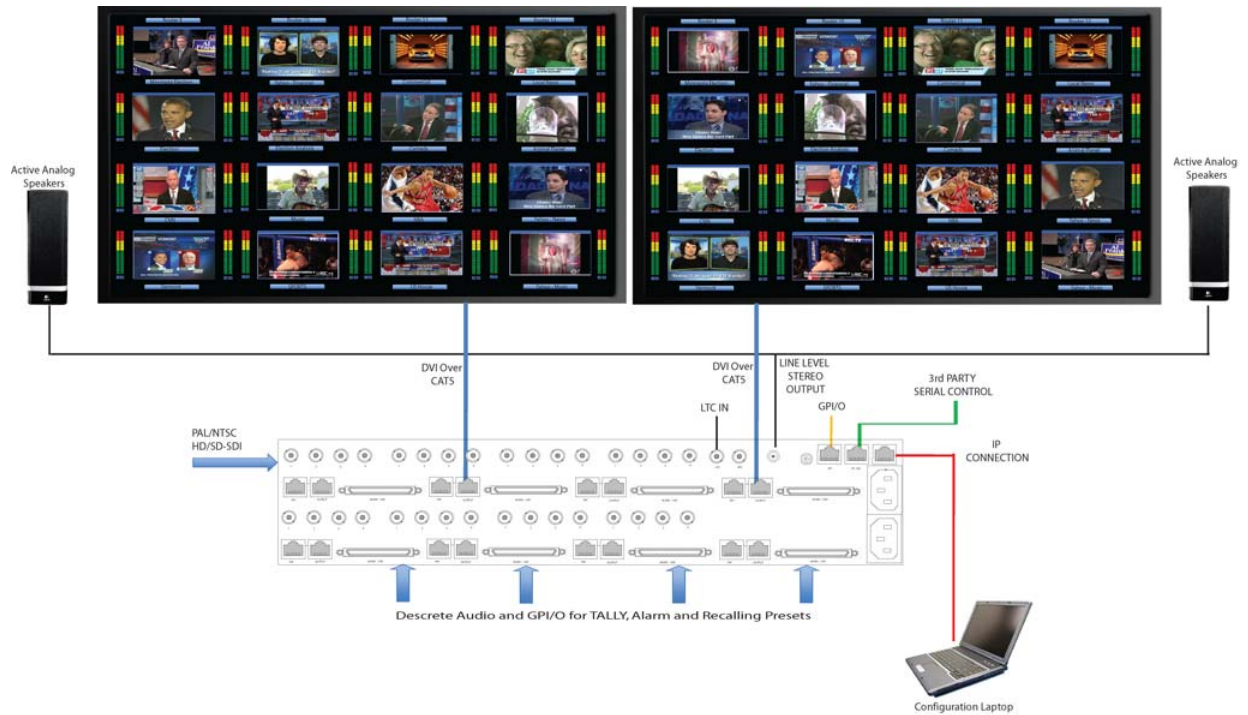

Figure 27: Tahoma LX-32 setup with 2 outputs, 16 windows each with audio meters

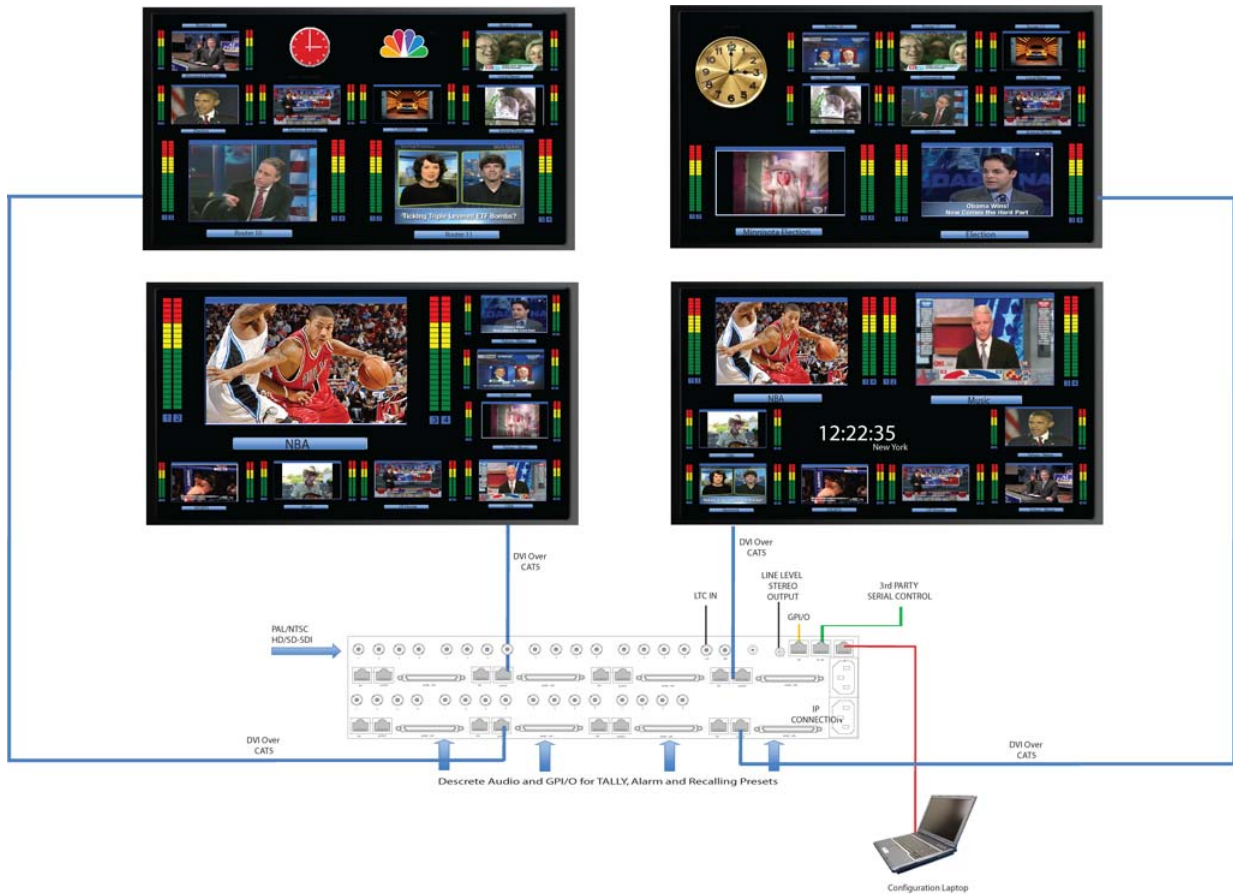

Figure 28: Tahoma LX-32 setup with 4 outputs, 8 windows each with audio meters and clocks

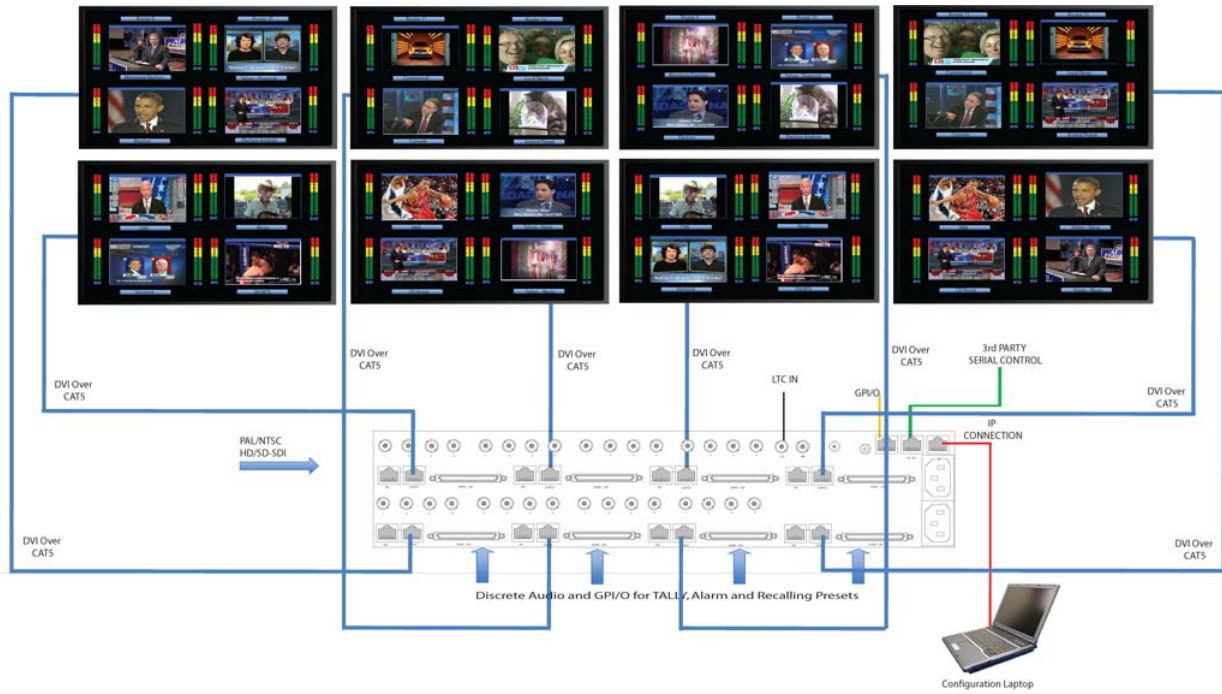
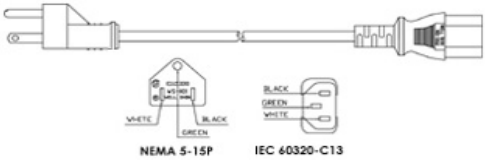







Figure 29: Tahoma LX-32 setup with 8 outputs, 4 windows each with audio meters

ACCESSORIES

Standard Accessories:

<p>Power cord (North American customers only)</p>  <p>NEMA 5-15P IEC 60320-C13</p>	<p>GPI breakout (on control board) – RJ45 to DB9</p> 
<p>GPI breakout (on video processing board) – Mini SCSI to DB9</p> 	<p>RJ45-DB9 converter for RS232 serial connection</p> 
<p>Rack mount</p> 	<p>CD, manual</p> 
<p>Terminal Block</p> 	

Optional Accessories:

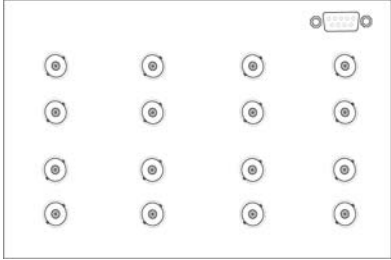
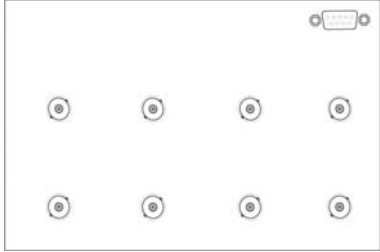
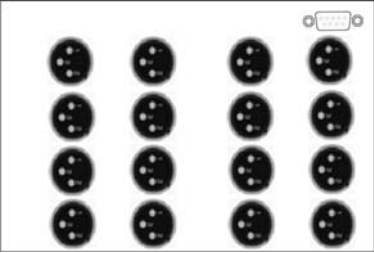
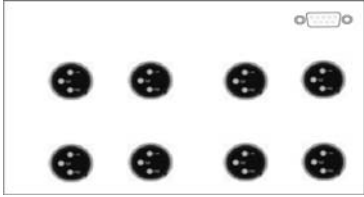
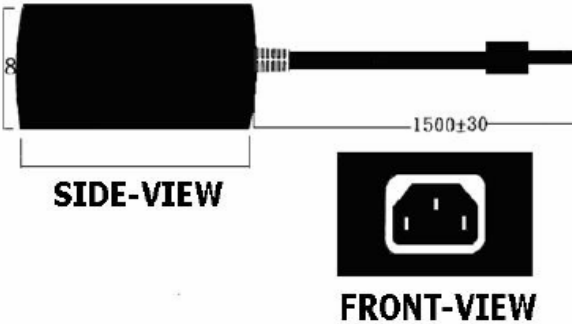
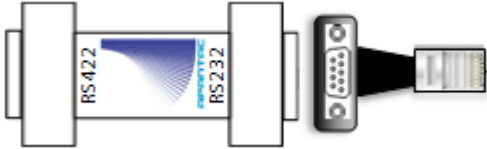
<p>Unbalanced Analog Audio breakout connector – Mini SCSI to BNC + DB9 (for GPI)</p> 	<p>Unbalanced AES audio breakout connector – Mini SCSI to BNC + DB9 (for GPI)</p> 
<p>Balanced Analog Audio breakout connector – Mini SCSI to BNC + DB9 (for GPI)</p> 	<p>Balanced AES audio breakout connector – Mini SCSI to BNC + DB9 (for GPI)</p> 
<p>Redundant Power Supply</p>  <p>SIDE-VIEW</p> <p>FRONT-VIEW</p>	<p>RS232 to 422 converter with RJ45 to DB9 cable- for TSL and other RS422 serial needs</p> 

APPENDIX A: CONNECTORS

BNC Inputs:

- 4 X BNC Connector
- Auto Detection for SDI and CVBS signal



Figure 30: 75 ohm BNC Connector

- SCSI Connector for Audio and GPI/O
- 8 GPIO
- 8 AES
- 16 Analog audio
- Others are Grounds
- TOTAL 68 PINS

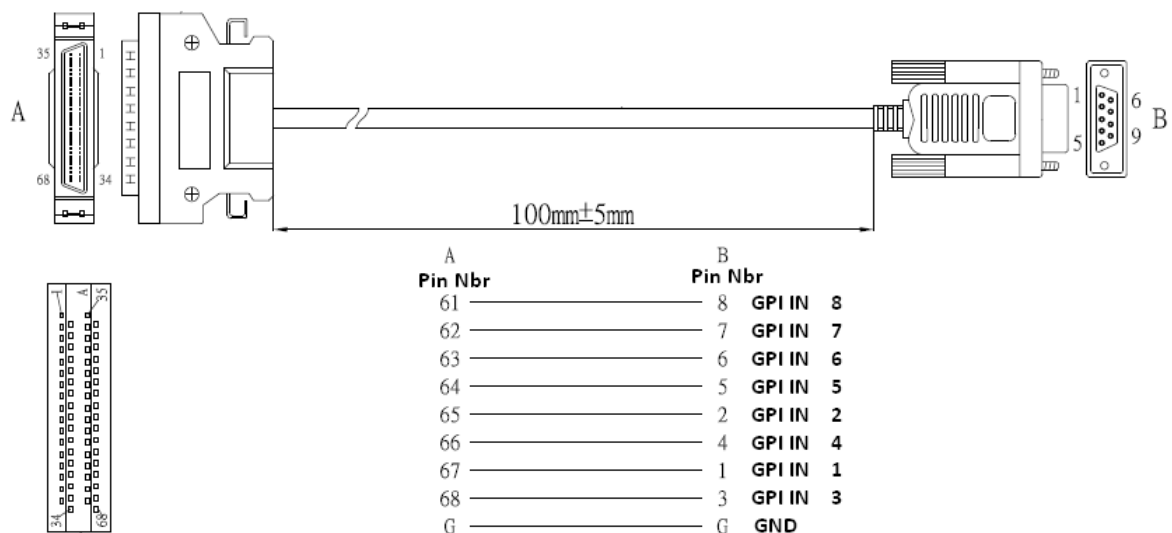
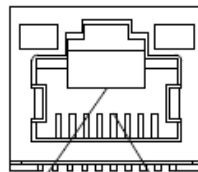

Figure 31: 68 pin SCSI Connector

Pin #	17	18	35	36	37	38	39	40	41	42
Function	AA #12	AES#4	AA #08	AA #07	AA #03	AA #04	AA #02	AA #14	AA #01	AA #13
43	44	45	46	47	48	51	52	53	55	56
AA #05	AA #09	AA #06	AA #16	AA #10	AA #15	AES #5	AES #11	AES #1	AES #06	AES #03
57	58	59	60	61	62	63	64	65	66	67
AES #2	AES #7	MODE A	MODE B	GPIO #08	GPIO #07	GPIO #06	GPIO #05	GPIO #02	GPIO #04	GPIO #1
68										
GPIO #3										

HDMI / DVI RJ45 Output Connector:

- 3 differential pairs for data
- 1 differential pair for clock
- Total 8 pins



Housing Insert

Figure 32: RJ45 connector

Pin #	1	2	3	4	5	6	7	8
Function	Clk+	Clk-	Data 2+	Data 1-	Data 1+	Data 2-	Data 0+	Data 0-

HDMI Input Connector

Pin #	1	2	3	4	5	6	7	8
Function	Clk+	Clk-	Data 2+	Data 1-	Data 1+	Data 2-	Data 0+	Data 0-

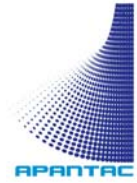

VGA RJ45 Connector:

- 3 for RGB
- 1 for HS
- 1 for VS
- Others are GND
- Total 8 pins

Pin #	1	2	3	4	5	6	7	8
Function	VS	HS	BLUE	GND	GREEN	GND	RED	GND

RS232 RJ45 Connector:

- 1 pin for Tx
- 1 pin for Rx
- 3 pins for 5V power
- 3 pins for GND

Pin #	1	2	3	4	5	6	7	8
Function	5V	GND	Tx	GND	Rx	GND	5v	5v

GPI I/O:

- RJ50 defined GPI I/O
- 8 pins GPI I/O
- 1 power alarm
- 1 GND

Pin #	1	2	3	4	5	6	7	8	9	10
Function	GPI I/O #1	GPI I/O #2	GPI I/O #3	GPI I/O #4	GPI I/O #5	GPI I/O #6	GPI I/O #7	GPI I/O #8	Power Alarm	GND

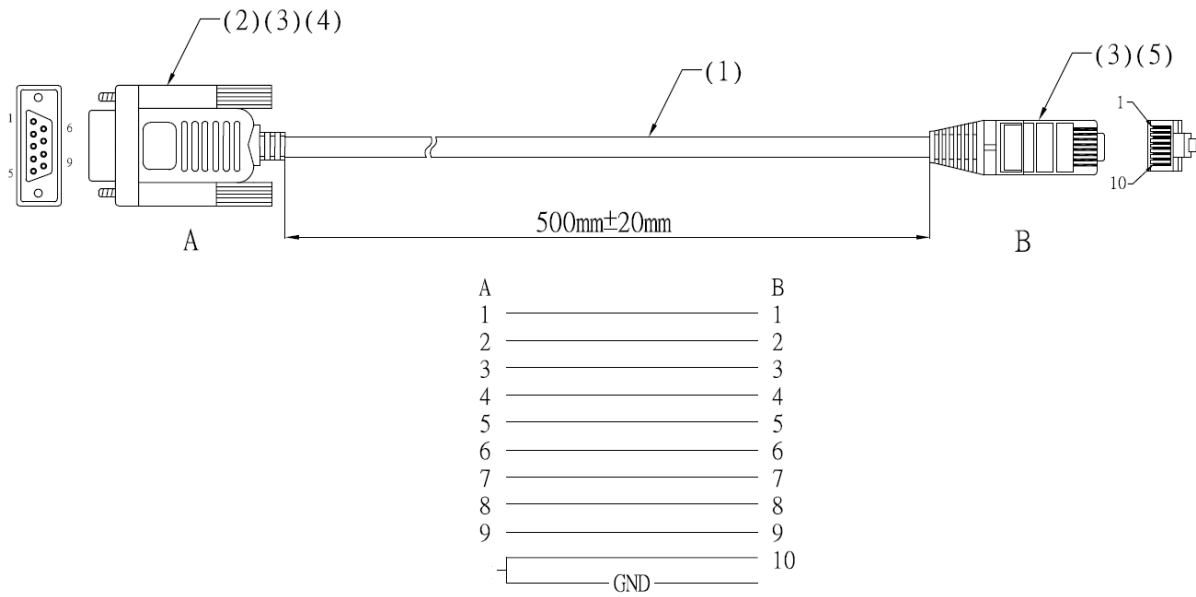

Figure 33: RJ50 to DB9 cable

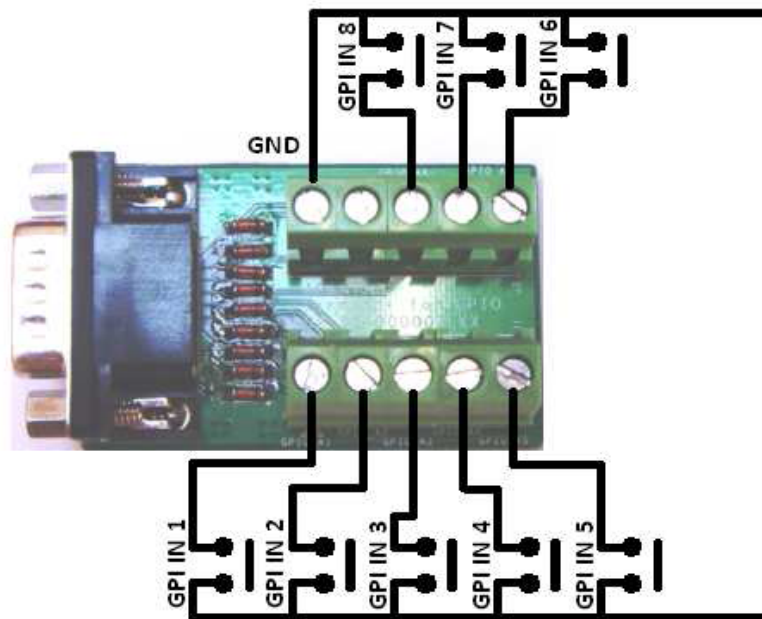

Figure 34: GPI-IN Wiring diagram. Connect this terminal block to the RJ50 to DB9 cable shown in Figure 33.

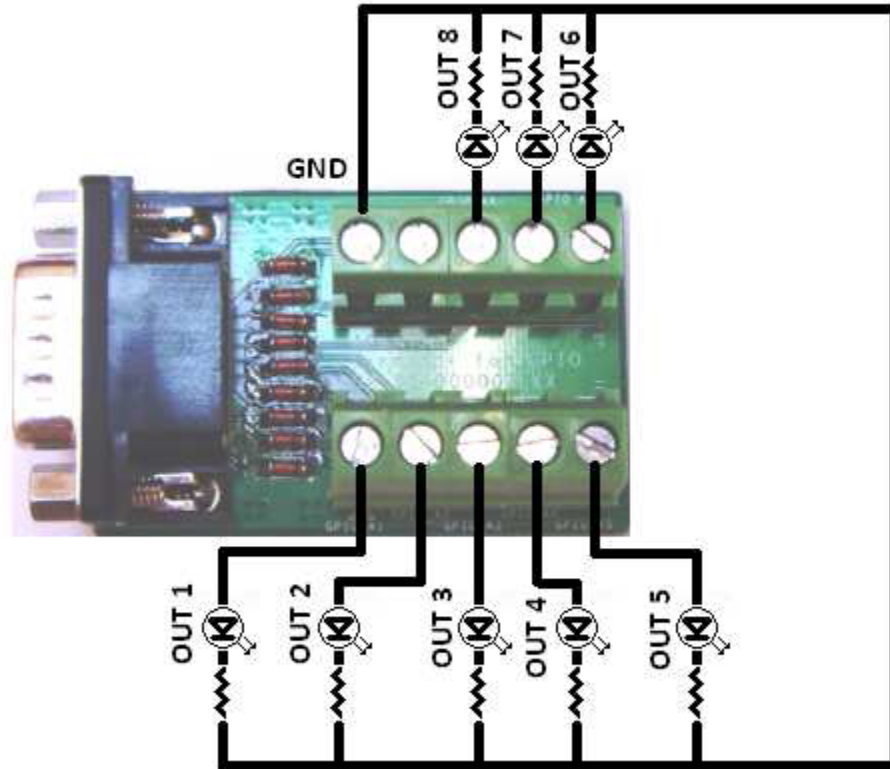
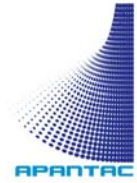

Figure 35: GPI-OUT Wiring diagram. Connect this terminal block to the RJ50 to DB9 cable shown in Figure 33. Note: All LED are standard LEDs, all resistors are 150 ohms



APPENDIX B: REDUNDANT POWER SUPPLIES

- Input: Universal 100-240 VAC / 47-63 HZ input, without any slide switcher output: 12V / 0~5A
- Case Dimension: 120L X 60W X 38 H MM
- Efficiency: 78% is typical
- Safety: UL/CUL/GS/PSE/BSMI
- EMI: FCC/CE Class B, conduction and radiation has been met.
- High frequency design, less power consumption
- CEC law (energy efficiency) has been met
- Over voltage protection, short circuit protection

Input:

Voltage	Range: Universal 100-200 VAC, single- phase Nominal: 100-120 VAC / 200-24-VAC
Frequency	47 – 63Hz
Current	1.5A Max
Inrush Current	30A Max/100VAC; 60A Max / 240VAC
Efficiency	78% minimum 9At normal line voltage, full Load)

DC Output:

Voltage	12.00V
Current	5A MAX
Regulation	Vo+-5%
Ripple- and Noise	200 mV Max
Total Power	60 W Max

Protection:

Over Voltage Protection	V out (110% - 140%)
Short Circuit Protection	Automatic recovery after short circuit fault removed

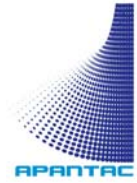

Operating and Environmental Performance:

Temperature Range

Operating	0 OC~C +40 OC
Storage	~ 20 OC~C +60 OC

Humidity Range (non-condensing)

Operating	OPERATING	20%~ 80% RH
Storage	STORAGE	10%~ 90% RH

Cooling should operate without fan
 MTBF: 50000 HOURS Min: 25OC FULL LOAD

MECHANICAL

WEIGHT: 320g
 CABLX- TYPE UL 1185 18AWG
 WIRE + PLUG BLACK
 PLUG: 5.5 X 2.5 X 10 mm



Lock Ring to secure connection
 CABLX- LX-NGTH: 150 cm
 CASE DIMENSION: 120 mm(L) x 60mm(W) x 38mm(H)
 EXTERNAL LOOK:

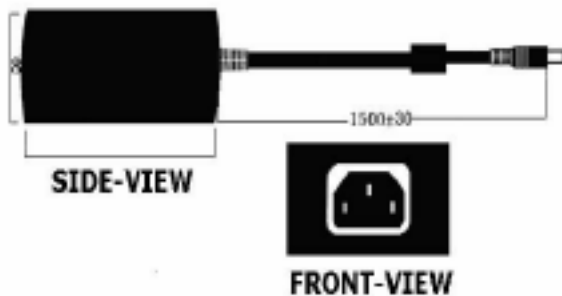

MATERIAL FLAMMABILITY: UL 94V-0

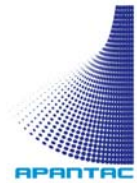

APPENDIX C: TAHOMA PLATFORM COMPARISON CHART

	TAHOMA-LE	TAHOMA-LX	TAHOMA-LI	TAHOMA-DE	TAHOMA-LC
INPUTS	4-32	16-32	4-16	2-16	4
INPUT FORMATS	HD-SDI SD-SDI Composite (PAL / NTSC)	HD-SDI SD-SDI	HD-SDI, SD-SDI or Composite (PAL / NTSC)	HDMI, DVI, VGA YPbPr, Composite, HD-SDI, SD-SDI	HD-SDI SD-SDI Composite (PAL / NTSC)
LOOPING INPUTS	No	No	Yes	No	No
EXTENDER	- Yes - Up to 35 feet with pas- sive receivers - Up to 115 feet with optional receivers	- Yes - Up to 35 feet with pas- sive receivers - Up to 115 feet with optional receivers	- Yes - Up to 35 feet with pas- sive receivers - Up to 115 feet with optional receivers	- Yes - Up to 35 feet with pas- sive receivers - Up to 115 feet with optional receivers	- Yes - Up to 35 feet with pas- sive receivers - Up to 115 feet with optional receivers
ROUTER	No	Yes	No	No	No
OUTPUTS	1-8	1-8	1-4	1-4	1
TOTAL WINDOWS	4, 8, 12, 16, 20, 24, 28, 32	4, 8, 12, 16, 20, 24, 28, 32	4, 8, 12 or 16	4, 8, 12 or 16	4
OUTPUT FORMATS	- DVI, HDMI - VGA - option - SDI - option	- DVI, HDMI - VGA - option - SDI - option	- DVI, HDMI - VGA - option - SDI - option	- DVI, HDMI - VGA - option - SDI - option	- DVI, HDMI - VGA - option - SDI - option
RESOLUTION	800 x 480 - 2048 x 1080 including 1920 x 1080 / 1080p				800 x 480 - 1920 x 1200 including 1920 x 1080 / 1080p
PRESETS	30	30	30	30	30
GRAPHICS	- Apantac Skin Technology - UMD, OMD, IMD, Tallies - Multiple labels per window - Borders - Clocks - Logos		- Apantac Skin Technology - UMD, OMD, IMD, Tallies - Multiple labels per window - Borders - Clocks - Logos		- UMD - Tallies - Borders
VIDEO / AUDIO ALARMS	No audio, audio high/ low, no video, video black, video frozen, WSS/ AFD	No audio, audio high/ low, no video, video black, video frozen, WSS/ AFD	No audio, audio high/ low, no video, video black, video frozen, WSS/ AFD	No audio, audio high/ low, no video, video black, video frozen	No audio, audio high/ low, no video, video black, video frozen, WSS/ AFD
AUDIO SUPPORT	- 16 channels embedded audio per input - 4 channels discrete analog or digital audio (option) - Audio associated with video windows or standalone audio meters - Analog or AES audio (option)				- 4 channels embedded audio per input
REDUNDANT POWER SUPPLY	- 1/2 width and 1RU - optional with external AC/ DC adapter - 2 RU - standard	- 1 RU - optional with external AC/DC adapter - 3 RU - standard	- 1 RU - optional with external AC/DC adapter - 2 RU - standard	- 1 RU - optional with external AC/DC adapter - 2 RU - standard	Optional with external AC/DC adapter
CONTROL	- Front panel buttons - Simple preset panel - Apantac ASCII protocol - Control Module with GPI inputs assigned to presets - Apantac Director Software	- Front panel buttons - Simple preset panel - Apantac ASCII protocol - Control Module with GPI inputs assigned to presets - Apantac Director Software	- Front panel buttons - Simple preset panel - Apantac ASCII protocol - Control Module with GPI inputs assigned to presets - Apantac Director Software	- Front panel buttons - Simple preset panel - Apantac ASCII protocol - Control Module with GPI inputs assigned to presets - Apantac Director Software	- Front panel buttons - Simple preset panel - Apantac ASCII protocol - Control Module with GPI inputs assigned to presets - Apantac Director Software
SIZE	1/2 wide 1 RU, 1 RU, 2 RU	1 RU 3 RU	1 RU 2 RU	1 RU 2 RU	1/2 wide 1 RU

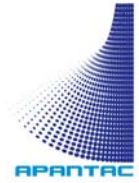

CONTACT APANTAC

For troubleshooting, support and service, as well as upgrades, please contact:

Phone: +1 503 616 3711

Email: support@apantac.com

Apantac

7556 SW Bridgeport Road

Portland, OR 97224

USA

Phone: +1 503 616 3711

Fax: +1 503 389 7921

Email: support@apantac.com

www.apantac.com