



4K Ultra HD Extender w/ RS-232 and 2-way IR

GTB-UHD2IRS-ELRPOL-BLK

User Manual



Release A1

Important Safety Instructions

1. Read these instructions.
2. Keep these instructions.
3. Heed all warnings.
4. Follow all instructions.
5. Do not use this product near water.
6. Clean only with a dry cloth.
7. Do not block any ventilation openings. Install in accordance with the manufacturer's instructions.
8. Do not install or place this product near any heat sources such as radiators, heat registers, stoves, or other apparatus (including amplifiers) that produce heat.
9. Do not defeat the safety purpose of the polarized or grounding-type plug. A polarized plug has two blades with one wider than the other. A grounding type plug has two blades and a third grounding prong. The wide blade or the third prong are provided for your safety. If the provided plug does not fit into your outlet, consult an electrician for replacement of the obsolete outlet.
10. Protect the power cord from being walked on or pinched particularly at plugs, convenience receptacles, and the point where they exit from the apparatus.
11. Only use attachments/accessories specified by the manufacturer.
12. To reduce the risk of electric shock and/or damage to this product, never handle or touch this unit or power cord if your hands are wet or damp. Do not expose this product to rain or moisture.
13. Unplug this apparatus during lightning storms or when unused for long periods of time.
14. Refer all servicing to qualified service personnel. Servicing is required when the apparatus has been damaged in any way, such as power-supply cord or plug is damaged, liquid has been spilled or objects have fallen into the apparatus, the apparatus has been exposed to rain or moisture, does not operate normally, or has been dropped.
15. Batteries that may be included with this product and/or accessories should never be exposed to open flame or excessive heat. Always dispose of used batteries according to the instructions.

Warranty Information

Gefen warrants the equipment it manufactures to be free from defects in material and workmanship.

If equipment fails because of such defects and Gefen is notified within two (2) years from the date of shipment, Gefen will, at its option, repair or replace the equipment, provided that the equipment has not been subjected to mechanical, electrical, or other abuse or modifications. Equipment that fails under conditions other than those covered will be repaired at the current price of parts and labor in effect at the time of repair. Such repairs are warranted for ninety (90) days from the day of reshipment to the Buyer.

This warranty is in lieu of all other warranties expressed or implied, including without limitation, any implied warranty or merchantability or fitness for any particular purpose, all of which are expressly disclaimed.

1. Proof of sale may be required in order to claim warranty.
2. Customers outside the US are responsible for shipping charges to and from Gefen.
3. Copper cables are limited to a 30 day warranty and cables must be in their original condition.

The information in this manual has been carefully checked and is believed to be accurate. However, Gefen assumes no responsibility for any inaccuracies that may be contained in this manual. In no event will Gefen be liable for direct, indirect, special, incidental, or consequential damages resulting from any defect or omission in this manual, even if advised of the possibility of such damages. The technical information contained herein regarding the features and specifications is subject to change without notice.

For the latest warranty coverage information, refer to the Warranty and Return Policy under the Support section of the Gefen Web site at www.gefen.com.

Technical Support

(818) 772-9100 (800) 545-6900
8:00 AM to 5:00 PM Monday - Friday, Pacific Time

Fax

(818) 772-9120

Email

support@gefen.com

Web

<http://www.gefen.com>

Mailing Address

Gefen, LLC
c/o Customer Service
20600 Nordhoff St.
Chatsworth, CA 91311

Product Registration

Register your product here: <http://www.gefen.com/kvm/Registry/Registration.jsp>

Operating Notes

- CAT-5e (or better) cables should always be used.
- The 4K Ultra HD Extender w/ RS-232 and 2-way IR will extend 1080p Full HD up to 495 feet (150 meters) and is limited to 8-bit color. 4K x 2K resolution can be extended up to 330 feet (100 meters). See [Distance Setting \(page 14\)](#) for more information.
- Power Over Line (POL) is a Gefen proprietary technology that provides power to the Receiver unit over a single CAT-5e (or better) cable. The included power supply can be connected to either the Sender or Receiver unit. *Never connect a power supply to both the Sender and Receiver unit.*
- This product passes through the display's EDID to the source. If the display is capable of accepting Deep Color, the source must be manually configured to output 8-bit color. This is only applicable when using 4K x 2K resolutions and "long-run" modes. See [Distance Setting \(page 14\)](#) for more information.

4K Ultra HD Extender w/ RS-232 and 2-way IR is a trademark of Gefen, LLC.

© 2014 Gefen, LLC. All Rights Reserved. All trademarks are the property of their respective owners.

Gefen, LLC reserves the right to make changes in the hardware, packaging, and any accompanying documentation without prior written notice.



This product uses UL or CE listed power supplies.

Features

- Extends 4K Ultra HD (3840 x 2160 @ 30 Hz, 8-bit color), RS-232, and bidirectional IR, up to 330 feet (100 meters) over a single CAT-5e cable (or better)
- Extends HDMI at 1080p Full HD, RS-232, and Bi-Directional IR, over a single CAT-5e (or better) cable up to 495 feet (150 meters) at 8-bit color or up to 330 feet (100 meters) at 12-bit deep color
- Supported HDMI Features
 - ▶ HDCP
 - ▶ 12-bit Deep Color
 - ▶ LPCM 7.1, Dolby® TrueHD, and DTS-HD Master Audio™
 - ▶ 3DTV pass-through
 - ▶ CEC pass-through
 - ▶ Lip-sync pass-through
- RS-232 extension
- 2-way IR extension from Sender to Receiver and from Receiver to Sender
- Gefen POL feature provides power to the Receiver unit over the link cable
- Uses Gefen's implementation of HDBaseT® technology
- EDID pass-through
- Locking power connector
- Surface mountable



Packing List

The following items are shipped with the 4K Ultra HD Extender w/ RS-232 and 2-way IR. If any of these items are not present in the box when you first open it, immediately contact your dealer or Gefen.

- 1 x 4K Ultra HD Extender w/ RS-232 and 2-way IR (Sender unit)
- 1 x 4K Ultra HD Extender w/ RS-232 and 2-way IR (Receiver unit)
- 1 x 6 ft. locking HDMI cable (M-M)
- 1 x 6 ft. DB-9 cable (M-F)
- 1 x IR extender
- 1 x IR emitter
- 1 x 24V DC locking power supply
- 1 x Quick-Start Guide

1 Getting Started

Introduction.....	2
Sender unit.....	2
Receiver unit.....	4
Installation.....	6
Connection Instructions.....	6
Sample Wiring Diagram.....	7

2 Basic Operation

Power LED Status.....	10
Sender unit LED.....	10
Receiver unit LED.....	11
IR Control.....	12
Controlling the Source from the Viewing Location.....	12
Controlling the Display from the Source Location.....	13
DIP Switch Configuration.....	14
Distance Setting.....	14

3 Appendix

Surface Mounting Instructions.....	18
Network Cable Diagram.....	19
Specifications.....	20
Index.....	21

4K Ultra HD Extender w/ RS-232 and 2-way IR

1

Getting Started

Introduction.....	2
Sender unit.....	2
Receiver unit	4
Installation	6
Connection Instructions.....	6
Sample Wiring Diagram	7

Sender unit

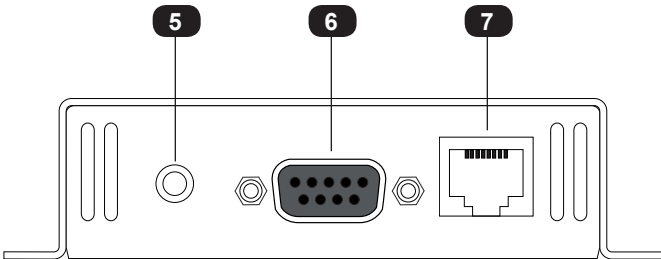
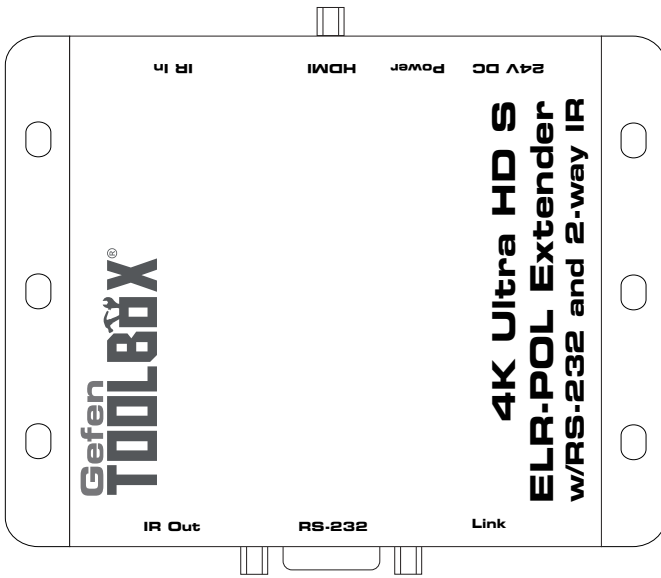
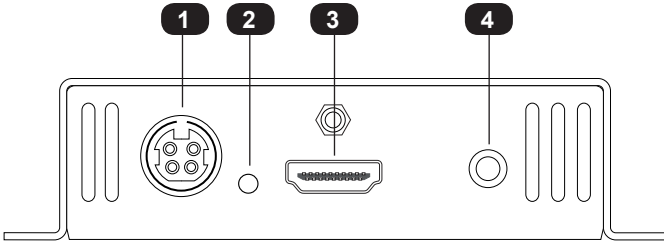

ID	Name	Description
1	24V DC	Connect the included 24V DC power supply to this power receptacle.
2	Power	This LED indicator will glow bright blue and will remain illuminated as long as the power supply is connected to the Sender unit. See Power LED Status (page 10) for details on LED status messages.
3	HDMI	Use the included HDMI cable to connect an Ultra Hi-Def source to this HDMI port.
4	IR In	Connect an IR extender (Gefen part no. EXT-RMT-EXTIRN) to this port. Alternatively, connect a mini-mono 3.5mm cable from this port to an automation system with an electrical IR output.
5	IR Out	Connect the included IR emitter from this port to the IR sensor of the device to be controlled.
6	RS-232	Connect the included RS-232 cable from this port to the automation device.
7	Link	Connect a CAT-5e cable (or better), up to 495 feet (150 meters), from this port to the Link port on the Receiver unit.

Receiver unit

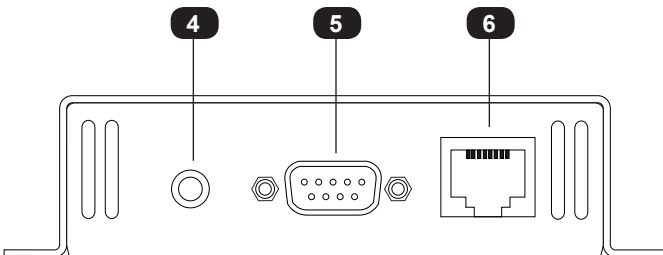
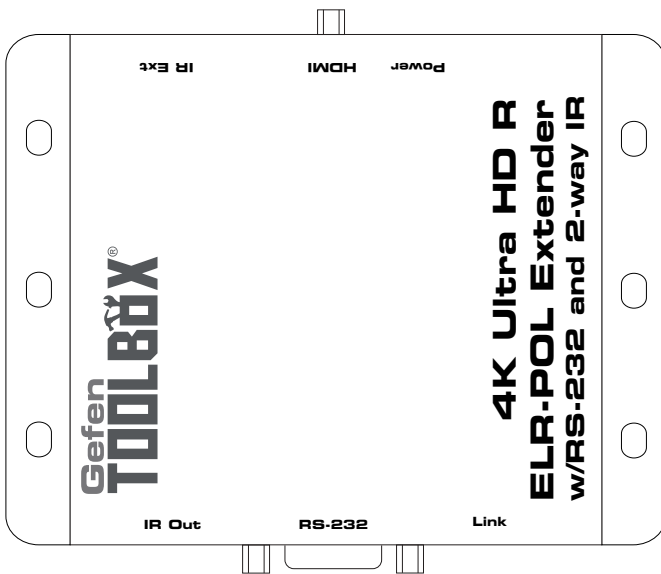
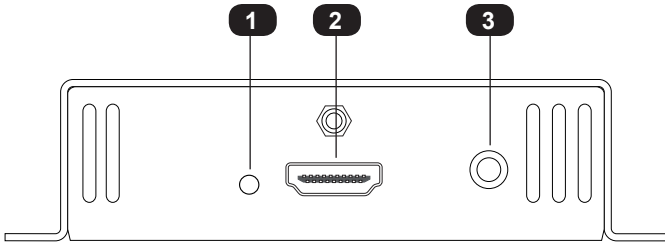

ID	Name	Description
1	Power	This LED indicator will glow bright blue and will remain illuminated as long as the power supply is connected to the Receiver unit. See Power LED Status (page 10) for details on LED status messages.
2	HDMI	Connect an HDMI cable between this port and an Ultra HD display.
3	IR Ext	Connect the included IR extender to this port. Alternatively, connect a mini-mono 3.5mm cable from this port to an automation system with an electrical IR output.
4	IR Out	Connect an IR emitter (Gefen part no. EXT-IREMIT) from this port to the IR sensor of the device to be controlled.
5	RS-232	Connect an RS-232 cable from this port to the RS-232 device to be controlled.
6	Link	Connect a CAT-5e cable (or better), up to 495 feet (150 meters), from this port to the Link port on the Sender unit.

Connection Instructions

▶ Video

1. Connect the included HDMI cable between the Ultra Hi-Def source and the **HDMI** port on the Sender unit.
2. Connect an Ultra HD display to the **HDMI** port on the Receiver unit using another HDMI cable.

▶ CAT-5

3. Connect a CAT-5e (or better) cable, up to 495 feet (150 meters) from the **Link** port on the Sender unit to the **Link** port on the Receiver unit.



Information

Resolution will affect extension distance. 1080p Full HD can be extended up to 495 feet (150 meters) and is limited to 8-bit color depth. 4K resolutions can be extended up to 330 feet (100 feet). Refer to [Distance Setting \(page 14\)](#) for details.

▶ IR

4. Refer to [IR Control \(page 12\)](#) for details on connecting IR devices.

▶ RS-232

5. Connect the included RS-232 cable from the automation device to the **RS-232** port on the Sender unit.
6. Connect an RS-232 cable from the **RS-232** port on the Receiver unit to the device to be controlled.

▶ Power

7. Connect the included 24V DC power supply to the power receptacle on the Sender unit.
8. Connect the opposite end of the power supply to an available electrical outlet.

Sample Wiring Diagram



CAT-5e CABLE 

HDMI CABLE 

IR 

RS-232 CABLE 

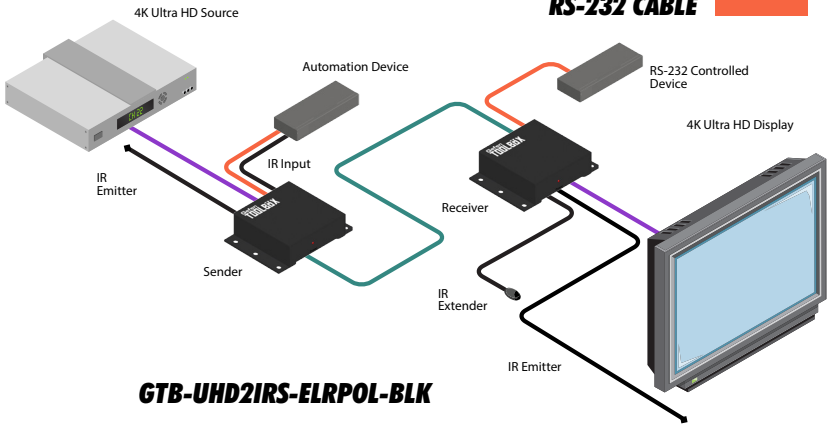

Information

The wiring diagram, shown above, requires an additional IR emitter (Gefen part no. EXT-IREMIT) and IR extender (Gefen part no. EXT-RMT-EXTIRN).





4K Ultra HD Extender w/ RS-232 and 2-way IR

2 Basic Operation





Power LED Status	10
Sender unit LED	10
Receiver unit LED	11
IR Control	12
Controlling the Source from the Viewing Location	12
Controlling the Display from the Source Location	13
DIP Switch Configuration	14
Distance Setting	14

The Power LED indicator on the Sender and Receiver unit provides basic information on the current status of the 4K Ultra Extender w/ RS-232 and 2-way IR.

Sender unit LED

Status		Description
Off		<ul style="list-style-type: none">• Sender unit is not powered.• Check the power supply.
Solid blue		<ul style="list-style-type: none">• Link is established between Sender and Receiver unit.• The Sender unit is receiving the source signal.
Flashing blue / orange	 	<ul style="list-style-type: none">• Non-HDCP content is being received by the Sender unit.
Solid orange		<ul style="list-style-type: none">• Sender unit is not receiving source signal from the source device.• Source is not connected. Check the cable between the Sender unit and the source device.

Receiver unit LED

Status		Description
Off		<ul style="list-style-type: none"> Receiver unit is not receiving power from Sender unit. Inspect CAT-5 cable between Sender and Receiver unit. Check the power supply.
Solid blue		<ul style="list-style-type: none"> Link is established between Sender and Receiver unit. Receiver unit is powered and is receiving the source signal from the Sender unit.
Flashing blue / orange	 	<ul style="list-style-type: none"> Non-HDCP content is being transmitted to the Receiver unit.
Solid orange		<ul style="list-style-type: none"> Receiver unit is not receiving source signal from the Sender unit. Inspect the CAT-5 cable between the Sender and Receiver unit.

Controlling the Source from the Viewing Location

1. Connect the included IR extender to the **IR Ext** port on the Receiver unit.
2. Connect the included IR emitter from the **IR Out** port on the Sender unit to the IR sensor on the source device.

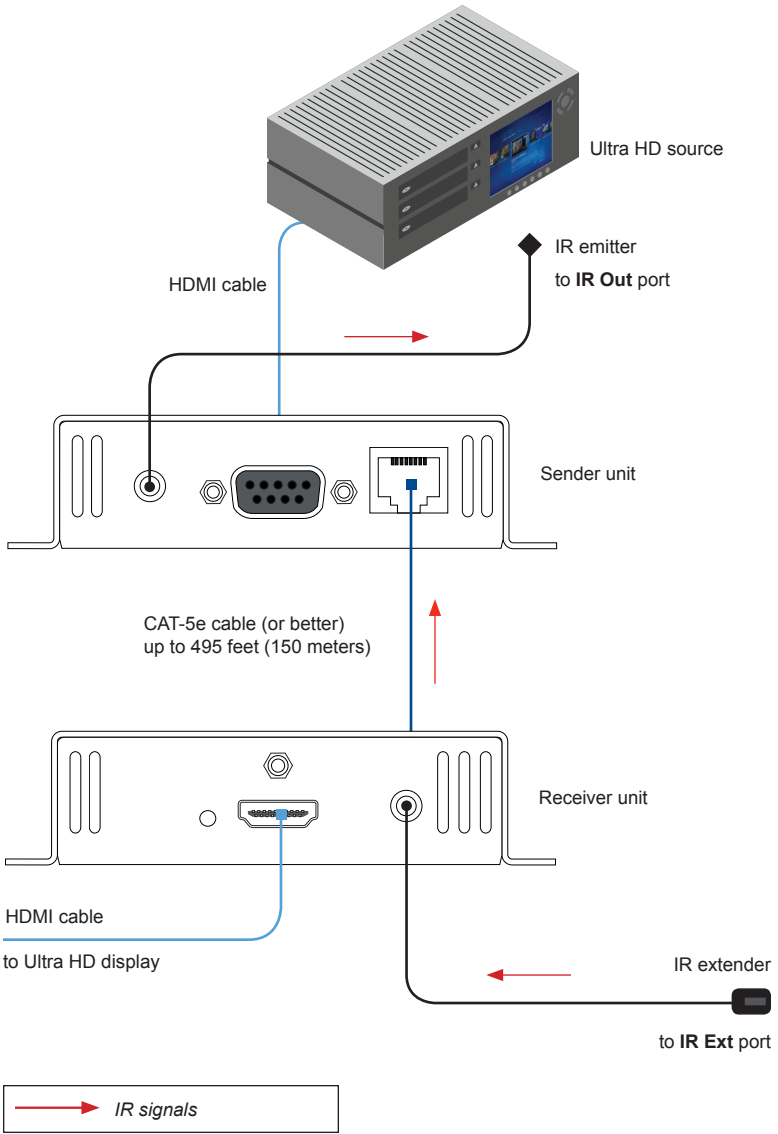

Controlling the Display from the Source Location

1. Connect the 3.5mm mini-mono connector from the **IR In** port on the Sender unit to the automation system.
2. Connect the included IR emitter from the **IR Out** port on the Receiver unit to the IR sensor on the display.

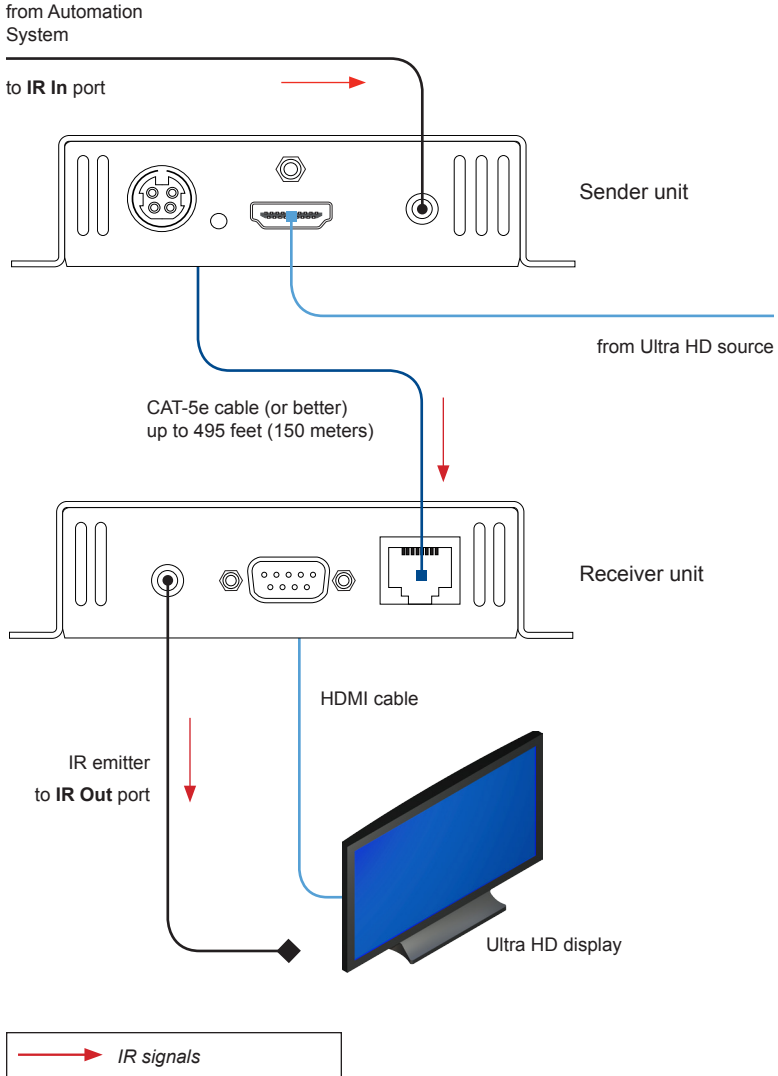

Distance Setting

This product passes through the display's EDID to the source. If the display is capable of accepting Deep Color, the source must be manually configured to output 8-bit color. This is only applicable when using 4K x 2K resolutions and "long-run" modes. The distance setting is controlled using a DIP switch on the bottom of the Receiver unit.

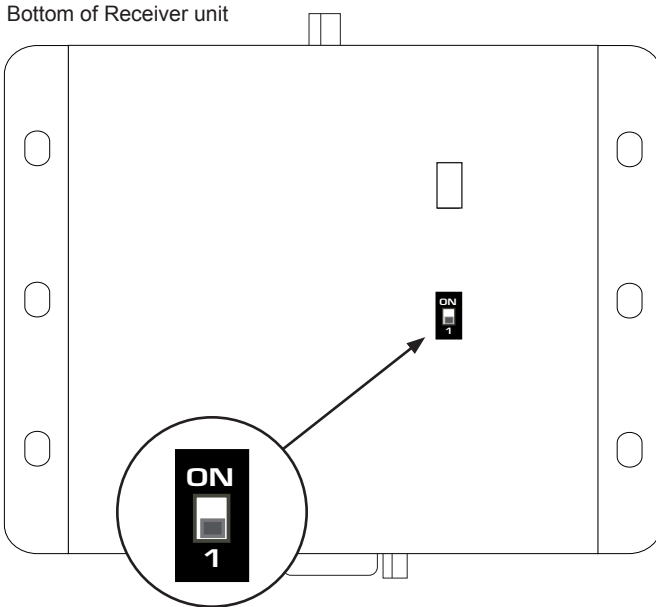

Position	Description
ON	<ul style="list-style-type: none">Allows resolutions up to 1080p Full HD to be extended to a maximum distance of 495 feet (150 meters).Color depth is limited to 8-bit.
OFF (1)	<ul style="list-style-type: none">This is the default settingAllows all resolutions, up to 4K x 2K, to be extended up to 330 feet (100 meters).

4K Ultra HD Extender w/ RS-232 and 2-way IR

3

Appendix

Surface Mounting Instructions.....	18
Network Cable Diagram	19
Specifications	20
Index.....	21

Surface Mounting Instructions

The Sender and Receiver units can be mounted on any flat surface, as shown below (screws not included). There should be an inch or two of clearance between the edges of the unit and any walls or vertical surfaces to allow for enough clearance for connection and disconnection of the HDMI cables.

For installation on a drywall surface, use a #6 drywall screw. When installing, it is recommended to use the center hole on a stud.

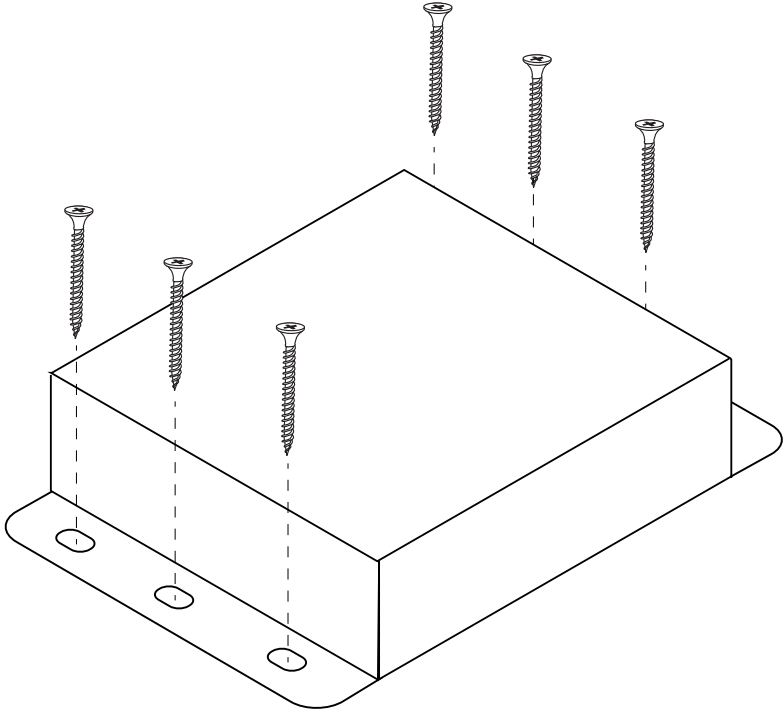

Front of RJ-45 Connector

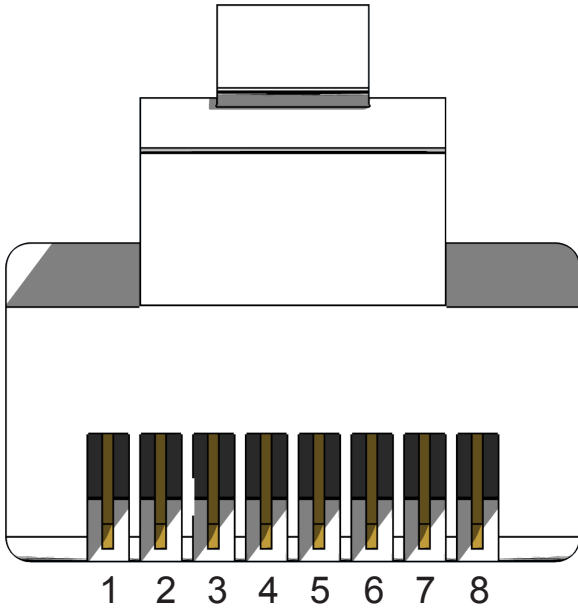

Gefen recommends the TIA/EIA-568-B wiring option. Use the following table when terminating cables in the field.

Pin	Color	Description
1	Orange / White	TD+ (Transmit Data, positive differential signal)
2	Orange	TD- (Transmit Data, negative differential signal)
3	Green / White	RD+ (Receive Data, positive differential signal)
4	Blue	Unused
5	Blue / White	Unused
6	Green	RD- (Receive Data, negative differential signal)
7	Brown / White	Unused
8	Brown / White	Unused

Shielded (STP) CAT-5e or CAT-6 is recommended. However, unshielded (UTP) CAT-5 or CAT-6 is acceptable. CAT-5, CAT-5e, and CAT-6 cabling comes in stranded and solid core types. Gefen recommends using solid core cabling. CAT-6 cable is also recommended.

It is recommended to use one continuous run from one end to the other. Patch cable is not recommended.

Supported Formats	
Video	<ul style="list-style-type: none"> • 4K x 2K • 1920 x 1200 (WUXGA) • 1080p Full HD
Audio	<ul style="list-style-type: none"> • 7.1 Linear PCM • Dolby® TrueHD • DTS-HD Master Audio™

Connectors, Indicators, and Controls	
HDMI (Sender)	<ul style="list-style-type: none"> • 1 x HDMI Type A, 19-pin, female
HDMI (Receiver)	<ul style="list-style-type: none"> • 1 x HDMI Type A, 19-pin, female
Link (Sender / Receiver)	<ul style="list-style-type: none"> • 1 x RJ-45, shielded, female
IR In (Sender / Receiver)	<ul style="list-style-type: none"> • 1 x 3.5mm, female
IR Out (Sender / Receiver)	<ul style="list-style-type: none"> • 1 x 3.5mm, female
RS-232 (Sender)	<ul style="list-style-type: none"> • 1 x DB-9, male
RS-232 (Receiver)	<ul style="list-style-type: none"> • 1 x DB-9, female
Power (Sender)	<ul style="list-style-type: none"> • 1 x 4-pin, female
Power Indicator (Sender / Receiver)	<ul style="list-style-type: none"> • 1 x LED, blue
DIP switch (Receiver)	<ul style="list-style-type: none"> • 1 x DIP switch

Operational	
Maximum Pixel Clock	<ul style="list-style-type: none"> • 300 MHz
Maximum TMDS Clock	<ul style="list-style-type: none"> • 300 MHz
Input Video Signal	<ul style="list-style-type: none"> • 1.2 Volts p-p
Input DDC Signal	<ul style="list-style-type: none"> • 5 Volts p-p (TTL)
Power Input	<ul style="list-style-type: none"> • 24V DC
Power Consumption	<ul style="list-style-type: none"> • 10 Watts (max.)
Operating Temperature	<ul style="list-style-type: none"> • +32 to +122 °F (0 to +50 °C)

Physical	
Dimensions (W x H x D) (Sender / Receiver)	<ul style="list-style-type: none"> • 4.3" x 1" x 3.2" (110mm x 26mm x 80mm)
Unit Weight	<ul style="list-style-type: none"> • 0.35 lb (0.2 kg)

C

Connection Instructions 6

D

DIP Switch Configuration 14

Distance setting. *See* DIP Switch Configuration

F

Features vi

I

Installation 6

L

LED Status 10

"long-reach" mode. *See* DIP Switch Configuration

M

Mounting Instructions 18

N

Network Cable Diagram 19

O

Operating Notes v

P

Packing List vii

Power LED Status 10

R

Receiver unit 4

LED status 11

S

Safety Instructions ii

Sender unit 2

LED status 10

Specifications 20

T

Table of Contents viii

Technical Support iv

W

Warranty Information iii

Wiring Diagram 7



20600 Nordhoff St., Chatsworth CA 91311
1-800-545-6900 818-772-9100 fax: 818-772-9120
www.gefen.com support@gefen.com