

## MODEL : SB-8804LCM

8x8 DIGITAL-AUDIO MATRIX SWITCHER



## 8x8 DIGITAL-AUDIO MATRIX SWITCHER

### **Digital - Audio Matrix Switcher Series**

*Thank you for purchasing the SB-8804LCM 8x8 DIGITAL-AUDIO Matrix Switcher. You will find this unit easy to install and highly reliable but it is essential that you read this manual thoroughly before attempting to use this switcher.*



## SAFETY INFORMATION



1. To ensure the best results from this product, please read this manual and all other documentation before operating your equipment. Retain all documentation for future reference.
2. Follow all instructions printed on unit chassis for proper operation.
3. To reduce the risk of fire, do not spill water or other liquids into or on the unit, or operate the unit while standing in liquid.
4. Make sure power outlets conform to the power requirements listed on the back of the unit. Keep unit protected from rain, water and excessive moisture.
5. Do not attempt to clean the unit with chemical solvents or aerosol cleaners, as this may damage the unit. Dust with a clean dry cloth.
6. Do not use the unit if the electrical power cord is frayed or broken. The power supply cords should be routed so that they are not likely to be walked on or pinched by items placed upon or against them, paying particular attention to cords and plugs, convenience receptacles, and the point where they exit from the appliance.
7. Do not force switched or external connections in any way. They should all connect easily, without needing to be forced.
8. Always operate the unit with the AC ground wire connected to the electrical system ground. Precautions should be taken so that the means of grounding of a piece of equipment is not defeated.
9. AC voltage must be correct and the same as that printed on the rear of the unit. Damage caused by connection to improper AC voltage is not covered by any warranty.
10. Turn power off and disconnect unit from AC current before making connections.
11. Never hold a power switch in the "ON" position.
12. This unit should be installed in a cool dry place, away from sources of excessive heat, vibration, dust, moisture and cold. Do not use the unit near stoves, heat registers, radiators, or other heat producing devices.
13. Do not block fan intake or exhaust ports. Do not operate equipment on a surface or in an environment which may impede the normal flow of air around the unit, such as a bed, rug, carpet, or completely enclosed rack. If the unit is used in an extremely dusty or smoky environment, the unit should be periodically "blown free" of foreign dust and matter.
14. To reduce the risk of electric shock, do not remove the cover. There are no user serviceable parts inside. Refer all servicing to qualified service personnel. There are no user serviceable parts inside.
15. When moving the unit, disconnect input ports first, then remove the power cable; finally, disconnect the interconnecting cables to other devices.
16. Do not drive the inputs with a signal level greater than that required to drive equipment to full output.
17. The equipment power cord should be unplugged from the outlet when left unused for a long period of time.
18. Save the carton and packing material even if the equipment has arrived in good condition. Should you ever need to ship the unit, use only the original factory packing.
19. Service Information Equipment should be serviced by qualified service personnel when:
  - A. The power supply cord or the plug has been damaged.
  - B. Objects have fallen, or liquid has been spilled into the equipment.
  - C. The equipment has been exposed to rain
  - D. The equipment does not appear to operate normally, or exhibits a marked change in performance
  - E. The equipment has been dropped, or the enclosure damaged.

# TABLE OF CONTENTS

## CONTENTS

INTRODUCTION .....	1
FEATURES & SPECIFICATIONS .....	2
FRONT PANEL .....	3
BACK PANEL .....	6
REMOTE CONTROL .....	7
REMOTE PROTOCOL COMMANDS .....	8
RS-232 SERIAL INTERFACE .....	9
IR EXTENDER .....	10
TYPICAL APPLICATION .....	11

## INTRODUCTION

Congratulations on your purchase of one of the most innovative 8x8 Digital & Stereo Audio matrix switching product on the market Today. The SB-8804LCM is a true Matrix Routing Switcher for Digital Audio (compatible Composite Video signal) and Stereo Audio. Support Composite Video on digital port input and output. It is a 8 individual Digital Audio and Stereo Audio inputs with 8 individual Digital audio and Stereo Audio outputs. Because it is a matrix router, any input may be routed to any output; or the same input may be routed to all outputs or any combination. It completely eliminates the need to constantly move around audio input and output cables. The SB-8804LCM is useful for Matrix signals from Digital Audio and stereo audio source devices (such as: VCRs, Camcorders, Video Game Consoles, Video CDs, DVDs, Satellite Receivers, CAT5 Set Top Boxes, etc.) To Composite Video/Audio destination devices (such as: LCD TV, HDTV, Plasma displays, Projectors, etc.). Selection of inputs is made via the Front Panel push buttons or an Infrared Remote Control unit or PC RS-232.

## PACKAGE CONTENTS

Check that you have the following components;

- SB-8804LCM 8x8 Matrix Switcher
- RS-232 V2.0 Protocol Instructions
- Master wireless IR Remote Control (SW-8804)
- 19 inch Ear mount bracket (Part # 1U-440L)
- SB-100 IR Extender distance 984 feet (300M) Receiver pack.
- SB-100C IR Extender distance 6 feet (2M) Receiver Cable
- CD Contents : Manual, Windows GUI, ISP V1.0 Windows driver
- RS-232 Cable 6 feet (2M)
- Users Guide
- AC/DC Adapter: 12VDC, 2A Universal Type 50/60Hz, 100-230 VAC



## SAFETY PRECAUTIONS

Please read all instructions before attempting to unpack, install or operate this equipment and before connecting the power supply. Please keep the following in mind as you unpack and install this equipment:

- Always follow basic safety precautions to reduce the risk of fire, electrical shock and injury to persons.
- To prevent fire or shock hazard, do not expose the unit to rain, moisture or install this product near water.
- Never spill liquid of any kind on or into this product.
- Never push an object of any kind into this product through any openings or empty slots in the unit, as you may damage parts inside the unit.
- Do not attach the power supply cabling to building surfaces.
- Use only the supplied power supply unit (PSU). Do not use the PSU if it is damaged.
- Do not allow anything to rest on the power cabling or allow any weight to be placed upon it or any person walk on it.
- To protect the unit from overheating, do not block any vents or openings in the unit housing that provide ventilation and allow for sufficient space for air to circulate around the unit.

## DISCLAIMERS

The information in this manual has been carefully checked and is believed to be accurate. We assume no responsibility for any infringements of patents or other rights of third parties which may result from its use.

We assume no responsibility for any inaccuracies that may be contained in this document. We make no commitment to update or to keep current the information contained in this document.

We reserve the right to make improvements to this document and/or product at any time and without notice.

## COPYRIGHT NOTICE

No part of this document may be reproduced, transmitted, transcribed, stored in a retrieval system, or any of its part translated into any language or computer file, in any form or by any means — electronic, mechanical, magnetic, optical, chemical, manual, or otherwise — without express written permission and consent

© Copyright 1997. All Rights Reserved.

Version 1.2 NOV 2013

## TRADEMARK ACKNOWLEDGMENTS

All products or service names mentioned in this document may be trademarks of the companies with which they are associated.

# FEATURES & SPECIFICATIONS

## FEATURES

- Supports 8x inputs to 8x outputs Digital (SPDIF) & Stereo Audio Matrix Switcher
  - Input / Out put signals via Digital(SPDIF) or Composite Video & Stereo Audio(AR/ AL)
  - Higher Video Bandwidth 300MHz each path signals.
  - Supported selection buttons direct channel on front panel
  - Support Audio Volume control via Push Button select Audio Value from unit front panel (Stereo audio only)
  - Compatible with all Digital(SPDIF) and Stereo Audio devices, Digital port supports : Composite Video AR/AL port supported
  - Supported RS-232 serial interface protocol commands list
  - Control PC RS-232 Drive compatible with win-95/98/2000/xp
  - Various User Interface controls:
    - Attached Window based control software for Desktop or NB control by RS-232 port
    - Manual controlled by Front Panel button
    - IR remote control
    - IR Extension control
  - Support desktop with Ear mount and 19 inch 1U Rack mountable type panel
  - Power supply DC12 Volt, Universal Type Switch 100~230VAC, 50/60Hz
- 

## SPECIFICATIONS

- **Type of Switcher:** 8 in To 8 out, Digital (SPDIF) / Stereo Audio Matrix Switcher
- **I/O Signals:**
  - Digital : Digital or Composite Video 0.5~1.0Vpp, 75 Ohms, RCA(Orange)
  - Analog : Stereo Audio (AR/AL), Via 2x RCA connector(Red/white)
- **Video Bandwidth:** 300MHz (-3db), 200mVp-p
- **Digital Supported:** Digital Audio SPDIF, Composite Video and Component Video (Y)
- **Audio Supported:** Stereo Audio(AR/AL), Adjust Audio volume on each destination.
- **Low All Hostile Crosstalk:** -83 db@5MHz
- **Controls:** IR remote, Select buttons on the front panel & RS-232
- **PC RS-232 Control:** RS-232 interface serial via DRV on a PC
- **Gain Control:** 60MHz 0.1 db gain flatness
- **Dimensions (WxDxH):** 19 x 7.87 x 1.73 in (482x200x44mm)
- **Shipping Weight:** 2.85 Kgs / 4.75 lb
- **Safety Approvals:** CE, FCC, RoHS(2002/95/EC).
- **Power Supply:** DC12V / 2A (consumption 1250mA Max) Use Universal Switch Type 50/60Hz,100~230 VAC

As product improvements are continuous, specifications are subject to change without notice.

# FRONT PANEL

## FRONT PANEL

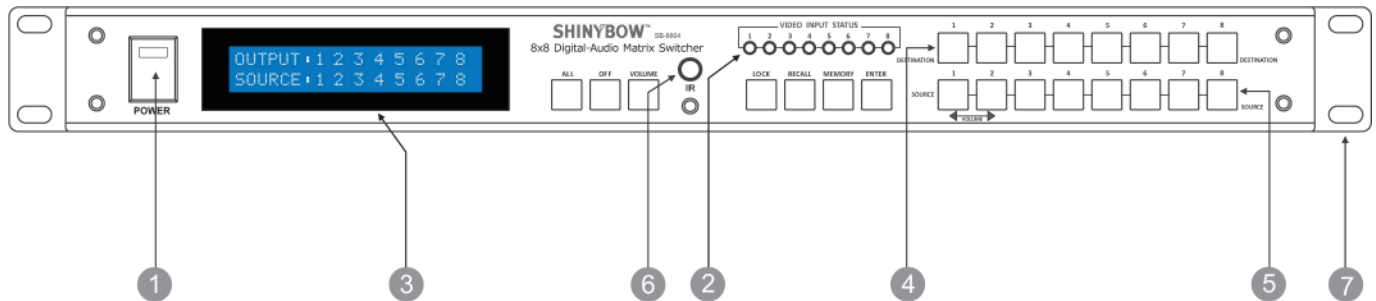

### 1. POWER ON SWITCH

The power switch turns the unit on and off. The LED will illuminate red to indicate that the switcher is ON and is receiving power. The Switcher will remember that last state during a power cycle. When power is removed and resorted, the last configuration will be evoked.

### 2. INPUT STATUS DISPLAY

Input sources 1 to 8 LED illuminates blue to indicate that a Composite video source is present on that input.

### 3. OUTPUT STATUS DISPLAY

Each Output (destination) Channel shows which input (source) is assigned.

### 4. DESTINATION SELECT BUTTONS

Separate outputs 1 thru 8 select buttons are provided for each destination assignment. Routing can be Source to Destination or one source to multiple destinations. **Example:** Press Destination 1,3,5 then press Source 2 will route Input 2 to Output 1,3,5 respectfully

### 5. SOURCE SELECT BUTTONS

Separate inputs 1 thru 8 select buttons are provided each source selection.

### 6. IR SENSOR

The IR sensor receives IR commands from the supplied remote controller or third party IR emitter.

### 7. 19 INCH EAR MOUNT PAIR

Converts desk-top to 19 inch rack mount bracket (part # 1U-440L) INCLUDED. Image shows rack mount bracket attached.

# FRONT PANEL

## FRONT PANEL

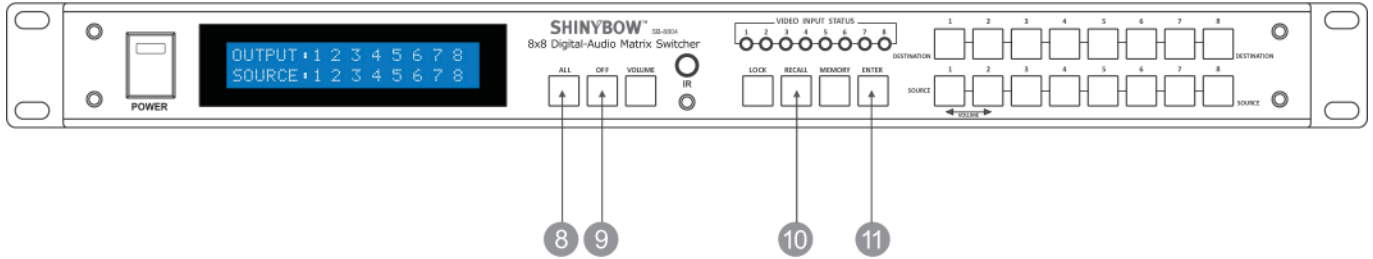

### 8. FUNCTION KEY - ALL

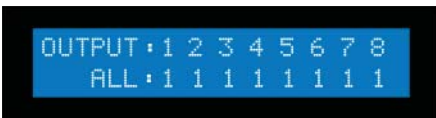

Disables (mute) video on all destinations OR Selects the same source to all destinations.

*Option 1*

- Press **ALL** followed by **OFF** button. The display will show "0" indicating all destinations have no video selected.

*Option 2*

- Press **ALL** followed by Source 1 thru 8. The display will show the Source selected.
- Press **ENTER**. The pre-set source selection will be assigned all destinations.

### 9. FUNCTION KEY - OFF

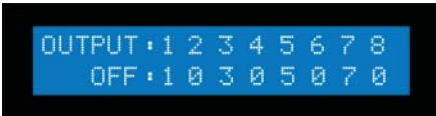

Disables (mute) video to selected channels. Either destinations.

- Press **OFF** button followed by any Destination channel.
- Press 1 thru 8 output destination. The display will show "0" for the selected channel indicating no video selected.

### 10. FUNCTION KEY - RECALL



The system will show previously stored presets, up to a total of 16. Presets are stored in local memory using Source keys 1 thru 8 or Destination keys 1 thru 8 as the memory preset location.

- Press **RECALL** button.
- Press 1 thru 8 on either Source or Destination row.
- Press **ENTER**. The pre-set configuration will execute.

Operation completes.

**Note:** Operation will abort if no keys are pressed within 5 seconds.

### 11. FUNCTION KEY - ENTER

Press **ENTER** to confirm entries.

# FRONT PANEL

## FRONT PANEL

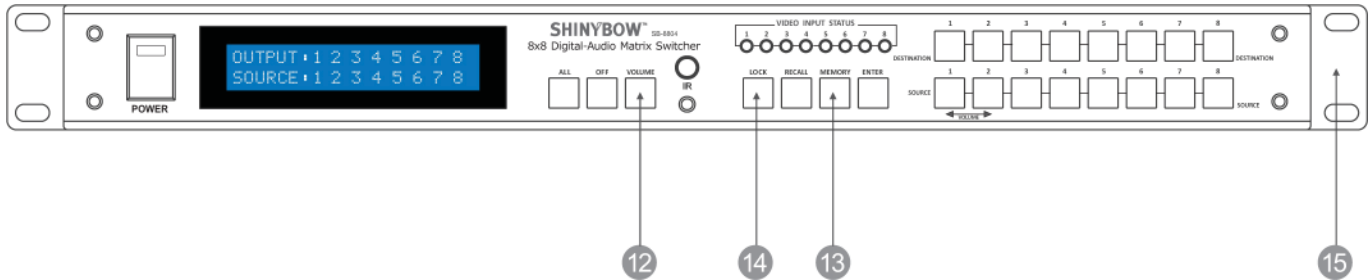

### 12. FUNCTION KEY - VOLUME



Repeatedly depressing the source 1 button will cycle down thru the options.  
Repeatedly depressing the source 2 button will cycle up thru the options.  
The button will flash blue and the display will show the current Audio volume +0~100 Status.

The system will show previously stored presets, up to a total of 8 outputs. Presets are stored in audio volume memory using Destination keys 1 thru 8 as the memory preset location.

- Press **VOLUME** button.
- Press 1 thru 8 on either Destination row.
- Press Source #1 or #2 button row for adjust the audio volume 0~100 level.
- Press **ENTER** The pre-set audio volume selection will be assigned all destinations.

Operation completes.

**Note:** Operation will abort if no keys are dressed within 5 seconds.

### 13. FUNCTION KEY - MEMORY



The system will show store presets, up to a total of 16. Presets are stored in local memory using Source keys 1 thru 8 or Destination keys 1 thru 8 as the memory preset location.

- Configure desired matrices .
- Press **MEMORY** button.
- Press 1 thru 8 on either Source or Destination row.
- Press **ENTER** to ready memory location.
- Or press **MEMORY** again to cancel operation.

Operation completes.

**Note:** Operation will abort if no keys are dressed within 5 seconds.

### 14. FUNCTION KEY - LOCK

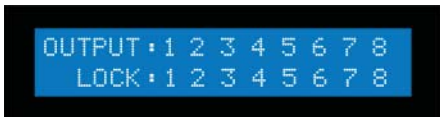

- Press and hold **LOCK** button for two seconds lockout the front panel.
- Press and hold **LOCK** button for two seconds to enable front panel.

### 15. 19 INCH EAR MOUNT PAIR

Converts desktop to 19 inch rack mount. Bracket (part # 1U-440L) INCLUDED. Image shows rack mount bracket attached.

# BACK PANEL

## BACK PANEL

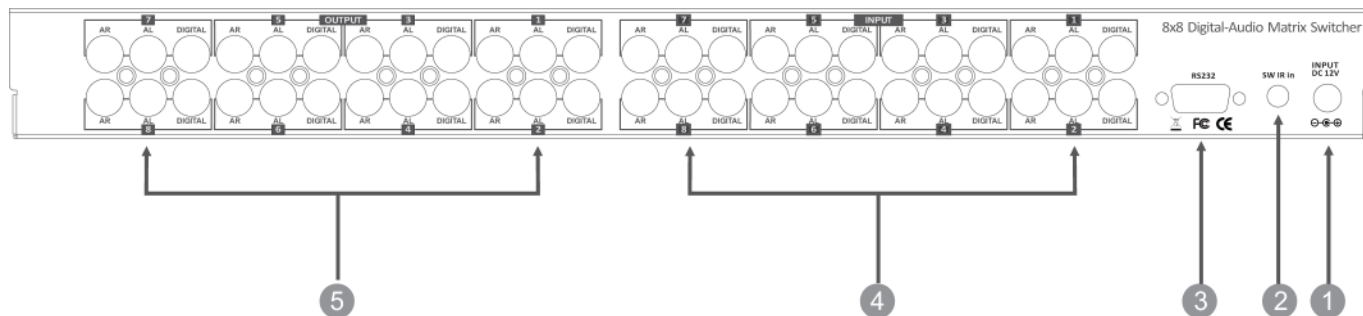

### 1. DC POWER INLET:

The switcher is fitted with a DC power plug input connector. Please ensure that the plug used is of an approved type and is of sufficient current carrying capacity with the correct voltage and connector polarity. 12Volt DC power supply 2A Max.



### Power Jack:

DC Jack - Inner OD Ø 2.1 mm (+)  
Outside OD Ø 5.5mm (GND)  
Power input -12VDC, 2A

### 2. IR EXTENDER CONTROL:

Support one of IR Extender (IR input) Extend distance maximum 984 ft. (300 m)



**IR Extender Jack:** Female Jack - inner OD Ø 3.5mm

### 3. RS-232 CONNECTION:

RS-232 control port to allow for interfacing to a PC, such as a computer or touch panel control, to the switcher via this DB-9pin Female connector for serial RS-232 control.

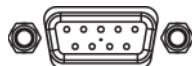

**Remote port:** DB-9pin Female connector

### 4. INPUTS-1~8 DIGITAL / AUDIO(AR/AL):

Connect a signal source of Digital audio or composite video and Stereo Audio (AR/AL) devise to 8x8 matrix switcher. Input 1~8 port source signals : Digital audio or composite video/ Stereo Audio.

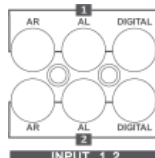

Digital Audio and Stereo Audio Via 3x RCA connectors

**Note: With 3x RCA female connectors.**

### 5. OUTPUTS-1~8 DIGITAL / AUDIO(AR/AL):

Connect a signal source of Digital audio or composite video and Stereo Audio (AR/AL) direct to Female RCA connector. This connector supports Digital audio or composite video and Stereo Audio display device.

Output 1~8 destination port signals : Digital audio or composite video and Stereo Audio.

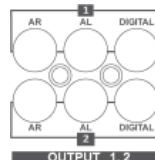

Digital Audio and Stereo Audio Via 3x RCA connectors

**Note: With 3x RCA female connectors.**

## CONNECTING THE HARDWARE

Please study the panel drawings below and become familiar with the signal input-output, Power requirements plus any controls present. Before using the switcher, please take the time to make certain that the device you wish to connect to its inputs is functioning properly in all respects. Verify that the video and audio signals are present and are being displayed properly on a suitable device. If all is well connect the appropriate cables between the output of the device you wish to distribute to output(s) of the switcher to the various devices you wish to feed a signal to. Lastly, connect the AC to DC adaptor, connect the DC connector to the switcher first and then plug the adaptor into a functional AC outlet.



# REMOTE CONTROL

## Before making any connections to the SB-8804LCM. Observe the following:

- Ensure the mains voltage supply matches the label on the supplied plug- Pack (+/- 10%).
- Ensure that the power switch is OFF.
- Ensure that all system grounds (earth) are connected to a common point.
- Avoid powering equipment within a system from multiple power sources that may be separated by large distances.
- Connect all audio video sources and destination equipment.
- Power up all source and destination audio-visual sources.
- For each destination output select the appropriate input source by using The front panel input 1-8 select buttons. The supplied IR remote control. Or through the RS-232 serial communications port.
- Upon power up the switcher will return to its last used setting before Powered down.

## REMOTE CONTROL

### IR REMOTE CONTROL KEY :

#### 1. & 2. SWITCH POWER ON or OFF:

Controller with a power ON and OFF

#### 3. DESTINATION : 1 thru 8 OUTPUT SELECTION:

Press the destination button to select the output display channel.

#### 4. SOURCE : 1 thru 8 INPUT SOURCE SELECTION:

Press input 1~8 sources with selection button

#### 5. AUDIO VOLUME KEY:

Adjust Audio Volume from +0 ~ +100 levels.

#### 6. FUNCTION KEY:

ALL - function selection button

OFF - function selection button

RECALL - function selection button

DEMO or ENTER - function selection button

MEMORY - function selection button

LOCK - function selection button

IR REMOTE : SW-8804 IR PCB : RA-02

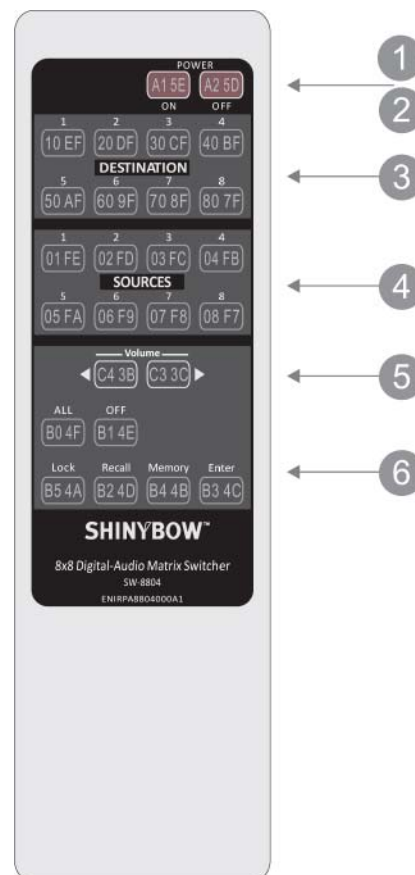

# REMOTE PROTOCOL COMMANDS

## IR REMOTE CUSTOM AND DATA CODES (NEC STANDARD)

### HOW TO SETUP IR CODES :

POWER ON : 40BF A15E  
POWER OFF : 40BF A25D  
ALL : 40BF B04F  
OFF : 40BF B14E  
LOCK : 40BF B54A

### CUSTOM CODE : 40BF

VOLUME + : 40BF C33C  
VOLUME - : 40BF C43B  
RECALL : 40BF B24D  
ENTER : 40BF B34C  
MEMORY : 40BF B44B

### PRESS TV DESTINATION - # then PRESS SOURCE - #

DESTINATION #1 : 40BF 01FE	SOURCE #1 : 40BF 01FE
DESTINATION #2 : 40BF 02FD	SOURCE #2 : 40BF 02FD
DESTINATION #3 : 40BF 03FC	SOURCE #3 : 40BF 03FC
DESTINATION #4 : 40BF 04FB	SOURCE #4 : 40BF 04FB
DESTINATION #5 : 40BF 50AF	SOURCE #5 : 40BF 05FA
DESTINATION #6 : 40BF 609F	SOURCE #6 : 40BF 06F9
DESTINATION #7 : 40BF 078F	SOURCE #7 : 40BF 07F8
DESTINATION #8 : 40BF 087F	SOURCE #8 : 40BF 08F7

---

For example;

Select Destination # 1 to show Source #1~8,

The IR Data Code list when press Destination # then press Source #

Press Destination # 1 & Source #1 40BF 01FE 40BF 01FE  
Press Destination # 1 & Source #2 40BF 01FE 40BF 02FD  
Press Destination # 1 & Source #3 40BF 01FE 40BF 03FC  
Press Destination # 1 & Source #4 40BF 01FE 40BF 04FB  
Press Destination # 1 & Source #5 40BF 01FE 40BF 05FA  
Press Destination # 1 & Source #6 40BF 01FE 40BF 06F9  
Press Destination # 1 & Source #7 40BF 01FE 40BF 07F8  
Press Destination # 1 & Source #8 40BF 01FE 40BF 08F7

# RS-232 SERIAL INTERFACE

## RS-232

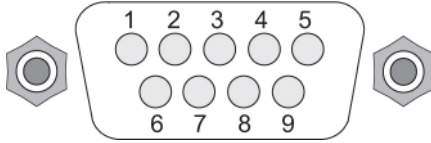

Pin	RS-232	Definition
1	-----	Not used
2	TX	Transmitter
3	RX	Receiver
4	-----	Not used
5	GND	Ground
6	-----	Not used
7	-----	Not used
8	-----	Not used
9	-----	Not used

### RS-232 PROTOCOL COMMANDS ( RS-232 Control driver V2.0.1 )

The ShinybowUSA switcher can be controlled via the RS-232 serial control port to allow for interfacing to a PC, or similar third party control system.

The serial communication parameters are 9600 baud, 8 bit, No Parity and 1 stop bit - this is often referred to as 9600 8N1. When the unit recognizes a complete command it will perform the requested action - there is no delimiter character required.

# IR EXTENDER

## REAR PANEL IR EXTENDER PORT

### 1. SB-100 IR 300M Receiver

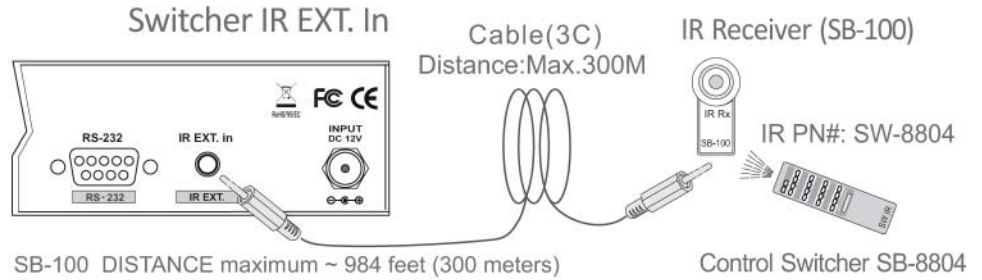

### 2. SB-100C IR 2M Receiver IR Receiver cable 6ft (2M)

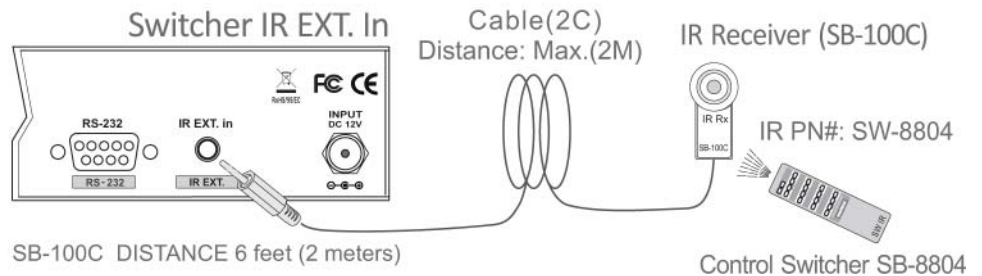

**Note: When you plug the External IR extender into the switcher, the front panel IR receiver remains active.**

## IR EXTENDER PACKAGE :

### HOW TO SETUP THE IR EXTENDER COMPONENTS

Pin configuration for IR 984 feet (300 meters) Extender Receiver such as **SB-100** compatible



Tip: Signal  
Ring :VCC  
Sleeve: GND

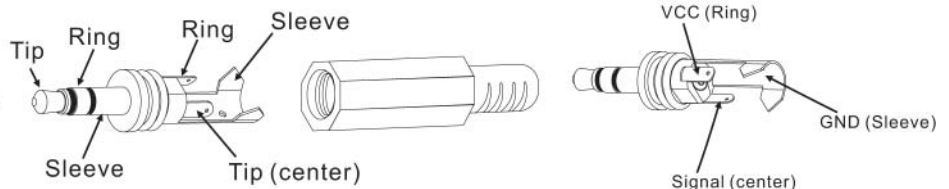

SB-100 Receiver and SB-101 Transmitter The DISTANCE maximum ~ 984 feet (300 meters)

Pin configuration for IR Receiver 6 feet (2 meters) cable such as **SB-100C** compatible



Tip: Signal  
Ring: NC  
Sleeve: GND

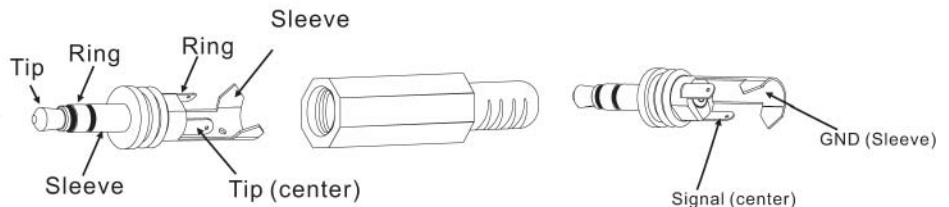

SB-100C Receiver Cable and SB-101C Transmitter Cable The DISTANCE maximum 6 feet (2 meters)

**Note: The External IR jack has voltage on the "Ring" portion of a 3-conductor plug. You must use a 3-conductor plug (aka: stereo plug). Using a 2-conductor plug will short out the power supply. Always make connections with the switcher power off.**

# TYPICAL APPLICATION

## 8X DIGITAL / AUDIO SOURCES TO 8X DIGITAL / AUDIO OUTPUT MATRIX SWITCHER

SB-8804LCM

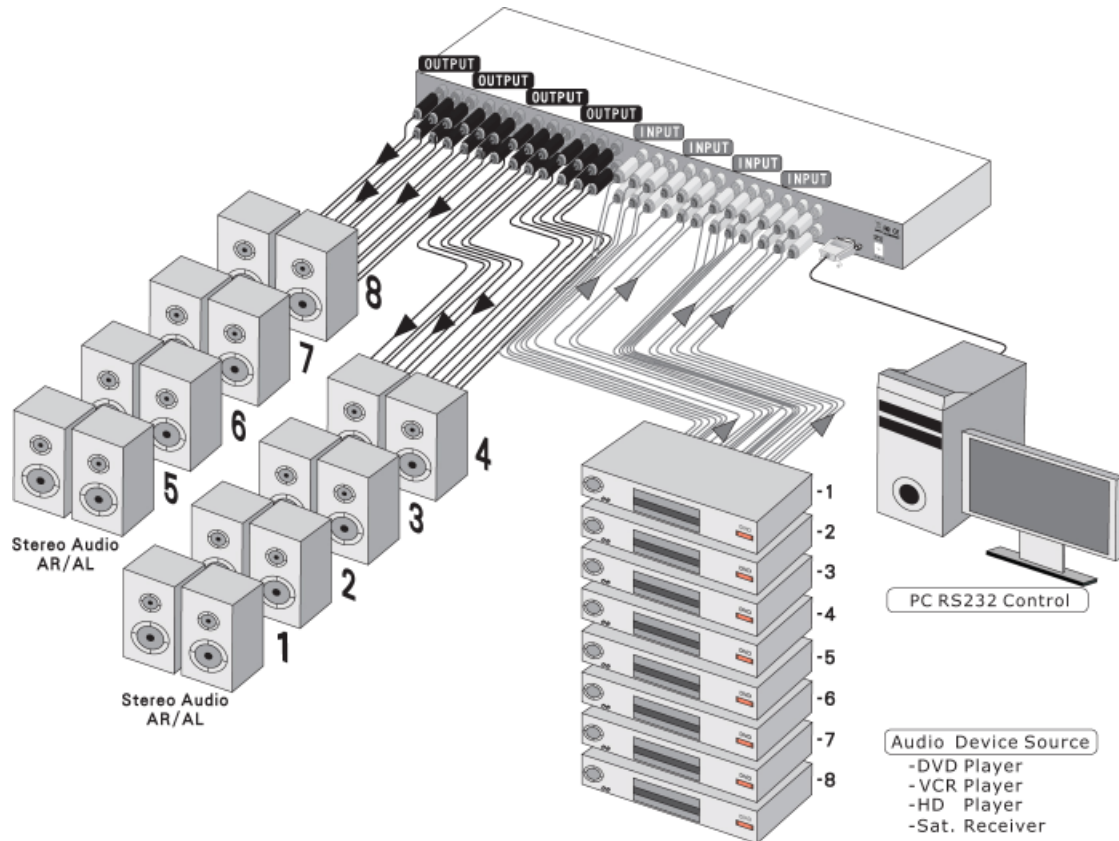

## INSTALLING

### CONTROL PORTS:

1. IR REMOTE - IR Remote Controller
2. RS-232 Interface - RS-232 interface system

### INPUTS 1 ~ 8 PORT DIGITAL / AUDIO SOURCE SIGNALS:

- DIGITAL - Digital (SPDIF) or Composite Video, connector with RCA
- AUDIO - Stereo Audio (AR/AL), connector with RCA

### OUTPUT 1 ~ 8 PORT AUDIO SIGNALS DEVICE:

- DIGITAL - Digital (SPDIF) or Composite Video, connector with RCA
- AUDIO - Stereo Audio (AR/AL), connector with RCA

SB-8804LCM SUPPORT DIGITAL/AUDIO EIGHT INPUTS MATRIX TO EIGHT SWITCH OUTPUTS  
SUPPORT CONTROL IR & RS-232 INTERFACE SYSTEM PORTS.

# LIMITED WARRANTY

PLEASE READ THE FOLLOWING TERMS AND CONDITIONS CAREFULLY BEFORE USING THIS HARDWARE, COMPONENTS AND SOFTWARE PROVIDED BY, THROUGH OR UNDER SHINYBOWUSA, INC (COLLECTIVELY, THE "PRODUCT"). By using installing or using the Product, you unconditionally signify your agreement to these Terms and Conditions. If you do not agree to these Terms and Conditions, do not use the Product and return the Product to SHINYBOWUSA, Inc. at the return address set forth on the Product's packing label at your expense. SHINYBOWUSA, Inc. may modify these Terms and Conditions at anytime, without notice to you.

## **RESTRICTIONS ON USE OF THE PRODUCT**

It is your responsibility to read and understand the installation and operation instructions, both verbal and in writing, provided to you with respect to the Product. You are authorized to use the Product solely in connection with such instructions. Any use of the Product not in accordance with such instructions shall void any warranty pertaining to the Product. Any and all damages that may occur in the use of the Product that is not strictly in accordance with such instructions shall be borne by you and you agree to indemnify and hold harmless SHINYBOWUSA, Inc. from and against any such damage.

The Product is protected by certain intellectual property rights owned by or licensed to SHINYBOWUSA. Any intellectual property rights pertaining to the Product are licensed to you by SHINYBOWUSA, Inc. and/or its affiliates, including any manufacturers or distributors of the Product (collectively, "SHINYBOWUSA") for your personal use only, provided that you do not change or delete any proprietary notices that may be provided with respect to the Product.

The Product is sold to you and any use of any associated intellectual property is deemed to be licensed to you by SHINYBOWUSA for your personal use only. SHINYBOWUSA does not transfer either the title or the intellectual property rights to the Product and SHINYBOWUSA retains full and complete title to the intellectual property rights therein. All trademarks and logos are owned by SHINYBOWUSA or its licensors and providers of the Product, and you may not copy or use them in any manner without the prior written consent of SHINYBOWUSA, which consent may be withheld at the sole discretion of SHINYBOWUSA.

The functionality and usability of the Product is controlled by SHINYBOWUSA, Inc. from its offices within the State of Texas, United States of America. SHINYBOWUSA makes no representation that materials pertaining to the Product are appropriate or available for use in other locations other than the shipping address you provided with respect thereto. You are advised that the Product may be subject to U.S. export controls.

Disclaimers and Limitation of Liability

SHINYBOWUSA may change or modify the Product at any time, from time to time.

THE PRODUCT IS PROVIDED "AS IS" AND WITHOUT WARRANTIES OF ANY KIND EITHER EXPRESS OR IMPLIED. SHINYBOWUSA DOES NOT WARRANT OR MAKE ANY REPRESENTATIONS REGARDING THE USE OR THE RESULTS OF THE USE OF THE PRODUCT'S CORRECTNESS, ACCURACY, RELIABILITY, OR OTHERWISE.

SHINYBOWUSA has no duty or policy to update any information or statements pertaining to the Product and, therefore, such information or statements should not be relied upon as being current as of the date you use the Product. Moreover, any portion of the materials pertaining to the Product may include technical inaccuracies or typographical errors. Changes may be made from time to time without notice with respect to the Product.

TO THE FULLEST EXTENT PERMISSIBLE PURSUANT TO APPLICABLE LAW, SHINYBOWUSA DISCLAIMS ALL WARRANTIES, EXPRESS OR IMPLIED, INCLUDING, BUT NOT LIMITED TO IMPLIED WARRANTIES OF MERCHANTABILITY, FITNESS FOR A PARTICULAR PURPOSE AND NON-INFRINGEMENT. SHINYBOWUSA DOES NOT WARRANT THE ACCURACY, COMPLETENESS OR USEFULNESS OF ANY INFORMATION WITH RESPECT TO THE PRODUCT. SHINYBOWUSA DOES NOT WARRANT THAT THE FUNCTIONS PERTAINING TO THE PRODUCT WILL BE ERROR-FREE, THAT DEFECTS WITH RESPECT TO THE PRODUCT WILL BE CORRECTED, OR THAT THE MATERIALS PERTAINING THERETO ARE FREE OF DEFECTS OR OTHER HARMFUL COMPONENTS. SHINYBOWUSA WILL USE ITS REASONABLE EFFORTS TO CORRECT ANY DEFECTS IN THE PRODUCT UPON TIMELY WRITTEN NOTICE FROM YOU NOT TO EXCEED 10 BUSINESS DAYS AFTER RECEIPT BY YOU OF THE PRODUCT, BUT YOU (AND NOT SHINYBOWUSA) ASSUME THE ENTIRE COST OF ALL NECESSARY SERVICING, REPAIR AND CORRECTION THAT WAS CAUSED BY YOU UNLESS OTHERWISE AGREED TO IN A SEPARATE WRITING BY SHINYBOWUSA.

UNDER NO CIRCUMSTANCES, INCLUDING, BUT NOT LIMITED TO, NEGLIGENCE, SHALL SHINYBOWUSA BE LIABLE FOR ANY SPECIAL OR CONSEQUENTIAL DAMAGES THAT RESULT FROM THE USE OF, OR THE INABILITY TO USE THE PRODUCT IN ACCORDANCE WITH ITS SPECIFICATIONS, EVEN IF SHINYBOWUSA OR ITS REPRESENTATIVES HAVE BEEN ADVISED OF THE POSSIBILITY OF SUCH DAMAGES. IN NO EVENT SHALL SHINYBOWUSA'S TOTAL LIABILITY TO YOU FROM ALL DAMAGES, LOSSES, AND CAUSES OF ACTION (WHETHER IN CONTRACT, OR OTHERWISE) EXCEED THE AMOUNT YOU PAID TO SHINYBOWUSA, IF ANY, FOR THE PRODUCT.

END OF DOCUMENT

# SHINYBOW™ USA

MULTIMEDIA AUDIO AND VISUAL

---