

MODEL : SB-5685LCM

8x5 HDMI MATRIX SWITCHER



8x5 HDMI MATRIX SWITCHER

HDMI Matrix Switcher Series

Thank you for purchasing the SB-5685LCM HDMI Matrix Switcher. You will find this unit easy to install and highly reliable but it is essential that you read this manual thoroughly before attempting to use 8x5 HDMI Matrix switcher.



SAFETY INFORMATION



1. To ensure the best results from this product, please read this manual and all other documentation before operating your equipment. Retain all documentation for future reference.
2. Follow all instructions printed on unit chassis for proper operation.
3. To reduce the risk of fire, do not spill water or other liquids into or on the unit, or operate the unit while standing in liquid.
4. Make sure power outlets conform to the power requirements listed on the back of the unit. Keep unit protected from rain, water and excessive moisture.
5. Do not attempt to clean the unit with chemical solvents or aerosol cleaners, as this may damage the unit. Dust with a clean dry cloth.
6. Do not use the unit if the electrical power cord is frayed or broken. The power supply cords should be routed so that they are not likely to be walked on or pinched by items placed upon or against them, paying particular attention to cords and plugs, convenience receptacles, and the point where they exit from the appliance.
7. Do not force switched or external connections in any way. They should all connect easily, without needing to be forced.
8. Always operate the unit with the AC ground wire connected to the electrical system ground. Precautions should be taken so that the means of grounding of a piece of equipment is not defeated.
9. AC voltage must be correct and the same as that printed on the rear of the unit. Damage caused by connection to improper AC voltage is not covered by any warranty.
10. Turn power off and disconnect unit from AC current before making connections.
11. Never hold a power switch in the "ON" position.
12. This unit should be installed in a cool dry place, away from sources of excessive heat, vibration, dust, moisture and cold. Do not use the unit near stoves, heat registers, radiators, or other heat producing devices.
13. Do not block fan intake or exhaust ports. Do not operate equipment on a surface or in an environment which may impede the normal flow of air around the unit, such as a bed, rug, carpet, or completely enclosed rack. If the unit is used in an extremely dusty or smoky environment, the unit should be periodically "blown free" of foreign dust and matter.
14. To reduce the risk of electric shock, do not remove the cover. There are no user serviceable parts inside. Refer all servicing to qualified service personnel. There are no user serviceable parts inside.
15. When moving the unit, disconnect input ports first, then remove the power cable; finally, disconnect the interconnecting cables to other devices.
16. Do not drive the inputs with a signal level greater than that required to drive equipment to full output.
17. The equipment power cord should be unplugged from the outlet when left unused for a long period of time.
18. Save the carton and packing material even if the equipment has arrived in good condition. Should you ever need to ship the unit, use only the original factory packing.
19. Service Information Equipment should be serviced by qualified service personnel when:
 - A. The power supply cord or the plug has been damaged.
 - B. Objects have fallen, or liquid has been spilled into the equipment.
 - C. The equipment has been exposed to rain
 - D. The equipment does not appear to operate normally, or exhibits a marked change in performance
 - E. The equipment has been dropped, or the enclosure damaged.

TABLE OF CONTENTS

CONTENTS

| | |
|---------------------------------|----|
| INTRODUCTION & CONTENTS | 1 |
| FEATURES & SPECIFICATIONS | 2 |
| FRONT PANEL | 3 |
| REAR PANEL | 6 |
| REMOTE CONTROL | 7 |
| RS-232 SERIAL INTERFACE | 9 |
| EDID FUNCTIONS | 10 |
| TYPICAL APPLICATION | 13 |
| R EXTENDER | 15 |
| LIMITED WARRANTY | 16 |

INTRODUCTION

The SB-5685LCM is high-performance 8x5 matrix routing switcher for HDMI signals. This switcher supports data rates up to 6.75 Gbps, enabling 1080p HDMI formats and UXGA/WUXGA/DVI resolution to any HD display. High Definition Digital signals can be selected and distributed to any 5 outputs simultaneously. The Switcher is certified as being fully HDMI and HDCP compliant, with RoHS,CE,FCC certification. Support high resolution HDMI sources routed to HDMI displays, monitors, and projector or audio receivers. The EDID can be selected between eight (8) different modes. Control is provided via Front panel push buttons, IR remote, RS-232 or TCP/IP (not a web-browser). An RS-232 / TCP-IP Windows GUI interface is provided for matrix routing.

PACKAGE CONTENTS

Check that you have the following components;

- SB-5685LCM Matrix Routing Switcher
- IR remote controller (SW-5685)
- 19-inch ear mount bracket (Part # 1U-440 L)
- IR extender SB-100 receiver (300M length)
- IR extender SB-100C receiver (2M length)
- 13x HDMI connector use ISO screw(L5mm/OD3mm)
- CD contents: Windows GUI
- RS-232 Cable
- Users Guide
- Power Supply 12VDC, 5A Universal Type 50/60Hz, 100~240 VAC



SAFETY PRECAUTIONS

Please read all instructions before attempting to unpack, install or operate this equipment and before connecting the power supply. Please keep the following in mind as you unpack and install this equipment:

- Always follow basic safety precautions to reduce the risk of fire, electrical shock and injury to persons.
- To prevent fire or shock hazard, do not expose the unit to rain, moisture or install this product near water.
- Never spill liquid of any kind on or into this product.
- Never push an object of any kind into this product through any openings or empty slots in the unit, as you may damage parts inside the unit.
- Do not attach the power supply cabling to building surfaces.
- Use only the supplied power supply unit (PSU). Do not use the PSU if it is damaged.
- Do not allow anything to rest on the power cabling or allow any weight to be placed upon it or any person walk on it.
- To protect the unit from overheating, do not block any vents or openings in the unit housing that provide ventilation and allow for sufficient space for air to circulate around the unit.

DISCLAIMERS

The information in this manual has been carefully checked and is believed to be accurate. We assume no responsibility for any infringements of patents or other rights of third parties which may result from its use.

We assume no responsibility for any inaccuracies that may be contained in this document. We make no commitment to update or to keep current the information contained in this document.

We reserve the right to make improvements to this document and/or product at any time and without notice.

COPYRIGHT NOTICE

No part of this document may be reproduced, transmitted, transcribed, stored in a retrieval system, or any of its part translated into any language or computer file, in any form or by any means — electronic, mechanical, magnetic, optical, chemical, manual, or otherwise — without express written permission and consent

© Copyright 1997. All Rights Reserved.

Version 1.2 OCT 2013

TRADEMARK ACKNOWLEDGMENTS

All products or service names mentioned in this document may be trademarks of the companies with which they are associated.



FEATURES & SPECIFICATIONS

FEATURES

- 8x HDMI digital source devices matrix switched to 5x HDMI devices.
 - HDMI digital video w/embedded audio, DVI format and CEC/HDCP 2.0 compliant
 - Seven (7) function key control and worldwide (8) EDID modes for HDTV resolutions.
 - Link speeds of up to 6.75 Gbps (link clock rate of 340Mb Hz), Support HDMI 1.4a 3D formats.
 - Wide range of HD resolutions from PC XGA to WUXGA 1920x1200 and HDTV/DTV resolutions 480i/480p, 576i/576p, 720p, 1080i & 1080p
 - Compatible with all HDMI source devices, PC monitors, Plasma HD display, HDTV and audio receivers/amplifiers.
 - Digital Video TMDS formats Resolution up to 1080p-60 with Deep color 36-bit.
 - Digital Audio Support : - Dolby TrueHD, Dolby Digital, Dolby Digital Plug/ex
 - DTS, DTS-HD, DTS-HD Master, DTS-EX
 - PCM, PCM2, LPCM2
 - Various User Interface control:
 - Windows based GUI control via RS-232 port
 - Front Panel push button
 - IR wireless remote control
 - Third party RS-232 controller (via simple ASCII)
 - Support world wide control functions: ALL/OFF/RECALL/ENTER/MEMORY/EDID/LOCK
 - Support EDID modes :
 - Embedded EDID modes : FSS/H24-3D/H24-3D-M/H36-3D/H36-3D-M/DVI-D 1280x1024-60Hz/DVI-D 1920x1200-60Hz/AUTO
 - External modes : Learning mode
 - Automatic scanning input & output status via LED show on front panel.
 - Support preview output port simultaneously output #1.
 - Support IR Remote and IR Extender with distance up to ~ 1000 ft (300M) Maximum
 - EDID configuration via Internal modes.
 - Consumer Electronic Control (CEC) switch all open or OFF
- The Switcher will remember that last state during a power cycle. When power is removed and resorted, the last configuration will be invoked.

SPECIFICATIONS

- **Type of Switcher:** 8x HDMI inputs To 5x HDMI Outputs Matrix Switcher
- **HDMI Support:** HD 1080p-@60Hz, H36-bit Deep color, 3D (1.4a) formats
- **HDCP / CEC Support:** HDCP 2.0 Compliant, CEC Compliant
- **Video Bandwidth:** Double Data Rates: 225Mhz, Total 6.75Gbps bandwidth
- **Digital Video Support:** Full HD resolution: 480i / 480p / 720p / 1080i / 1080p
- **Digital Audio Support:** Multi Audio Formats 5.1 / 7.1, MAT(MLP), Dolby Digital, Dolby TrueHD, Dolby Digital Plus, DTS, DTS-ES 6.1, DTS-HD, DTS-HD-HRA, DTS-HD Master, (PCM-2CH)
- **Controls:**
 - IR Remote Controller
 - IR External port x 1 (OD 3.5mm Ear phone Jack)
 - Select & Function buttons on front panel
 - RS-232 series interface
- **Preview output:** Support 1x preview output port simultaneously via Output-#1
- **Source Status:** Automatically Scan Sources Inputs via LED
- **Function Control Key:** ALL / OFF / RECALL / ENTER / MEMORY / LOCK / EDID
- **Infrared Frequency:** 38 KHz
- **IR External Distance:** ~1000 feet / 300 meters maximum
- **HDMI I/O Connector:** HDMI Type A - SMD 19pin Female Type
- **Temperature:** 32 °F - 100 °F Operation (0 °C - 38 °C)
- **Dimensions (LxWxH):** 19* x 9.85 x 1.75 in (*with rackmount bracket) (482 x 250 x 44 mm)
- **Rack Mount:** 1RU High 19in Rack Mount (with rack mount)
- **Power Supply:** DC12V / 5A, Universal world wide Type 50/60Hz, 100~230 VAC
- **Power Consumption:** 3550 mA Maximum
- **Safety Approvals:** CE, FCC, RoHS (2002/95/EC)
- **Product Weight:** 2.40 Kgs / 4.0 lb

As product improvements are continuous, specifications are subject to change without notice.

FRONT PANEL

FRONT PANEL

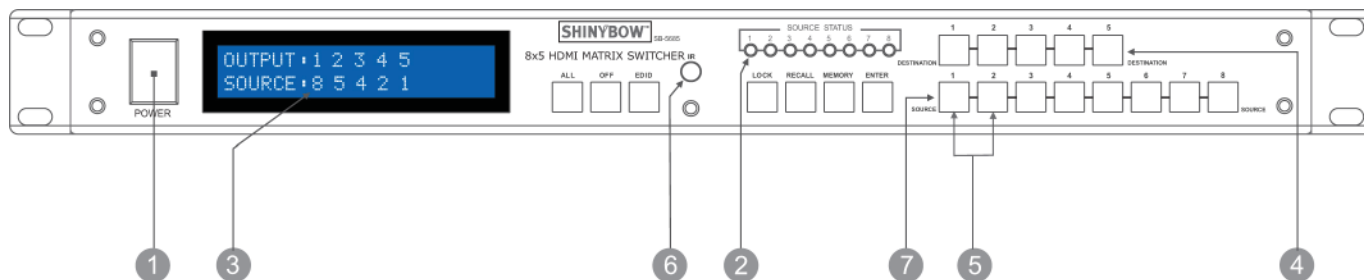

1. POWER SWITCH

The power switch turns the unit on and off. The LCM will illuminate red to indicate that the switcher is ON and is receiving power. The Switcher will remember that last state during a power cycle. When power is removed and resorted, the last configuration will be evoked.

2. INPUT STATUS DISPLAY

Input sources 1 to 5 LCM illuminates blue to indicate that a video source is present on that input.

3. OUTPUT STATUS DISPLAY

Each Output (destination) Channel shows which input (source) is assigned.

4. DESTINATION SELECT BUTTONS

Separate outputs 1 thru 5 select buttons are provided for each destination assignment.

Routing can be Source to Destination or one source to multiple destinations.

Example : Press Destination 1,3,5 then press Source 2 will route Input 2 to Output 1,3,5 respectfully.

5. EDID MODE SELECT BUTTONS

Used to select EDID mode using Input buttons #1 and #2.

6. IR SENSOR

The IR sensor receives IR commands from the supplied remote controller or third party IR emitter.

7. SOURCE SELECT BUTTONS

Separate inputs 1 thru 8 select buttons are provided each source selection.

FRONT PANEL

FRONT PANEL

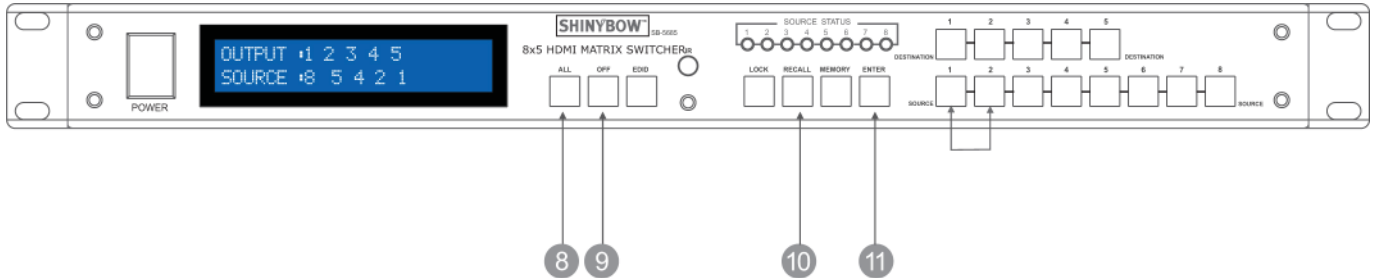

8. FUNCTION KEY - ALL

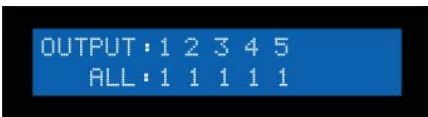

Disables (mute) video on all destinations OR Selects the same source to all destinations.

Option 1

- Press **ALL** followed by **OFF** button. The display will show " 0 " indicating all destinations have no video selected.

Option 2

- Press **ALL** followed by Source 1 thru 8. The display will show the Source selected.
- Press **ENTER** The pre-set source selection will be assigned all destinations.

9. FUNCTION KEY - OFF

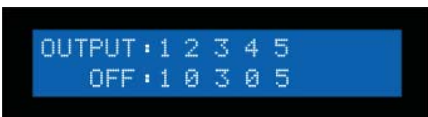

Disables (mute) video to selected channels. Either destinations.

- Press **OFF** button followed by any Destination channel.
- Press 1 thru 5 output destination. The display will show " 0 " for the selected channel indicating no video selected.

10. FUNCTION KEY - RECALL

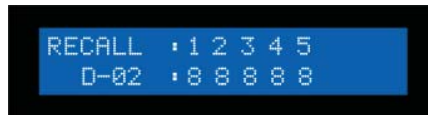

The system will show previously stored presets, up to a total of 13.

Presets are stored in local memory using Source keys 1 thru 8 or Destination keys 1 thru 5 as the memory preset location.

- Press **RECALL** button.
- Press 1 thru 8 on either Source or Destination row
- Press **ENTER** The pre-set configuration will execute.

Operation completes.

Note: Operation will abort if no keys are dressed within 5 seconds.

11. FUNCTION KEY - ENTER

Press **ENTER** to confirm entries.

FRONT PANEL

FRONT PANEL

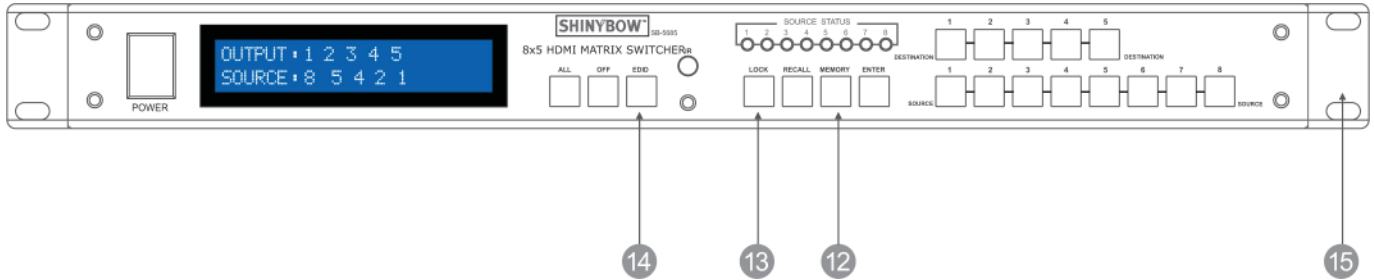

12. FUNCTION KEY - MEMORY



The system will show store presets, up to a total of 13.

Presets are stored in local memory using Source keys 1 thru 8 or Destination keys 1 thru 5 as the memory preset location.

- Configure desired matrices.
- Press **MEMORY** button.
- Press 1 thru 8 on either Source or 1 thru 5 Destination row.
- Press **ENTER** to ready memory location.
- Or press **MEMORY** again to cancel operation.

Operation completes.

Note : Operation will abort if no keys are pressed within 5 seconds.

13. FUNCTION KEY - LOCK



- Press and hold **LOCK** button for two seconds lockout the front panel.
- Press and hold **LOCK** button for two seconds to enable the front panel.

14. FUNCTION KEY - EDID



- Press **EDID** to select new EDID mode or select source row #1 or #2 for LINK source EDID again.
- Press the **DESTINATION** # to learn EDID the Destination EDID has been learned.

15. 19 INCH EAR MOUNT PAIR

Converts desktop to 19 inch rack mount. Bracket (part # 1U-440L) INCLUDED.

Image shows rack mount bracket attached.

REAR PANEL

REAR PANEL

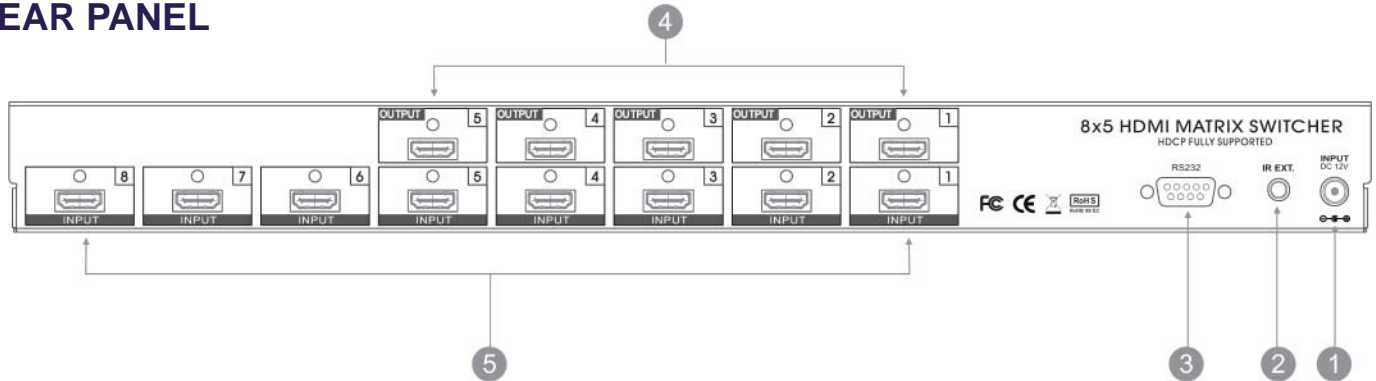

1. DC POWER INLET

The Switcher is fitted with a DC power plug input connector. Ensure that the used is of an approved type and is of sufficient current carrying connector capacity with the correct voltage and connector polarity. 12Volt DC power supply 5A Max (Center pin positive).



Power Jack:

DC Jack - Inner OD \approx 2.1mm (+)
 Outside OD \approx 5.5mm (GND)
 Power input - 12VDC, 5A

2. IR EXTENDER CONTROL

Support one of IR Extender. Extend distance max. 300 M / ~1000 ft. When you plug the External IR extender into the switcher, the front panel IR receiver remain active.



IR Extender Jack:

Female Jack - inner OD \approx 3.5 mm

3. RS-232 CONNECTION

RS-232 control port to allow for interfacing to a PC Such as a computer or touch panel control, to the switcher via this DB-9pin Female connector for serial RS-232 control.



Remote port :

DB-9pin Female connector

4. INPUTS- 1,2,3,4,5,6,7, & 8 HDMI

Connect a signal link of HDMI direct digital video/audio to this Female HDMI connector. This connector supports HDMI digital video/audio and DVI digital video sources.

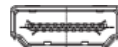

HDMI Digital Video/Audio, Connector with fix screw Input 1 ~ Input 8

HDMI digital video/audio connector:

HDMI Female connector.

Note: With the proper adapters, the switcher can be used with DVI digital video signals HDCP compliant. DVI does not support audio.

5. OUTPUTS- 1,2,3,4 & 5 HDMI

Connect a signal link of HDMI direct digital video/audio to this Female HDMI connector. This connector supports HDMI digital video/audio and DVI digital video sources.

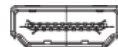

HDMI Digital Video/Audio, Connector with fix screw Output 1 ~ Output 5

HDMI digital video/audio connector:

HDMI Female connector.

Note: With the proper adapters, the switcher can be used with DVI digital video signals HDCP compliant.

REMOTE CONTROL

Before making any connections to the SB-5685LCM. Observe the following:

- > Ensure the mains voltage supply matches the label on the supplied plug- Pack (+/- 10%)
- > Ensure that the power switch is OFF
- > Ensure that all system grounds (earth) are connected to a common point.
- > Avoid powering equipment within a system from multiple power sources that may be separated by large distances
- > Connect all audio video sources and destination equipment
- > Power up all source and destination audio-visual sources
- > For each destination output select the appropriate input source by using the front panel input 1~8 select buttons. The supplied IR remote control. Or through the RS-232 serial communications port.
- > Upon power up the switcher will return to its last used setting before Powered down.

REMOTE CONTROL

1. & 2. SWITCH POWER ON or OFF:

Controller with a power ON and OFF

3. DESTINATION : 1 thru 5 OUTPUT SELECTION:

Press the destination button to select the output display channel.

4. SOURCE : 1 thru 8 INPUT SOURCE SELECTION:

Press input 1~8 sources with selection button

5. FUNCTION KEY:

ALL - function selection button
OFF - function selection button
EDID - function selection button
RECALL - function selection button
MEMORY - function selection button
ENTER - function selection button
LOCK - function selection button

IR REMOTE : SW-5685

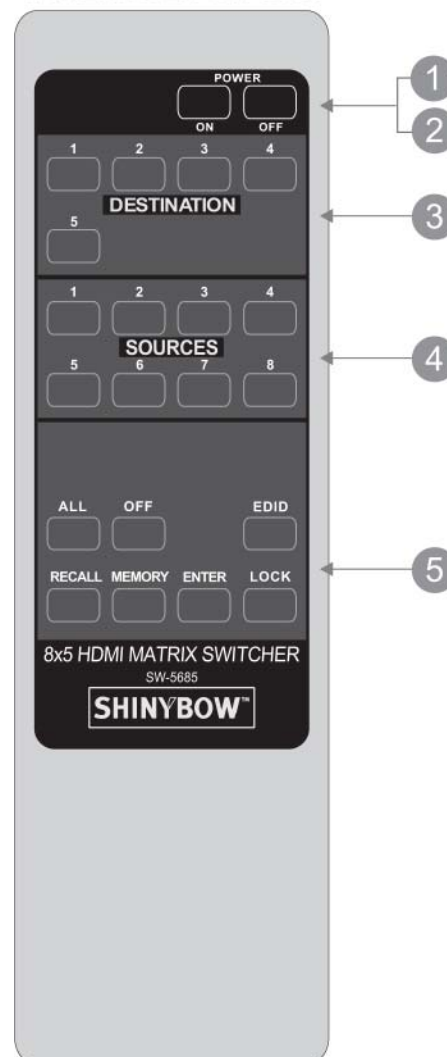

REMOTE CONTROL

IR REMOTE CUSTOM AND DATA CODES (NEC STANDARD)

HOW TO SETUP IR CODES

CUSTOM CODE : 23DC

DATA CODE :

POWER ON : 23DC A15E

POWER OFF : 23DC A25D

ALL : 23DC B04F

OFF : 23DC B14E

EDID : 23DC B748

LOCK : 23DC B54A

RECALL : 23DC B24D

MEMORY : 23DC B44B

ENTER : 23DC B34C

PRESS TV DESTINATION - # then PRES AV SOURCE -

DESTINATION #1 : 23DC 10EF

DESTINATION #2 : 23DC 20DF

DESTINATION #3 : 23DC 30EF

DESTINATION #4 : 23DC 40BF

DESTINATION #5 : 23DC 50AF

SOURCE #1 : 23DC 01FE

SOURCE #2 : 23DC 02FD

SOURCE #3 : 23DC 03FC

SOURCE #4 : 23DC 04FB

SOURCE #5 : 23DC 05FA

SOURCE #6 : 23DC 06F9

SOURCE #7 : 23DC 07F8

SOURCE #8 : 23DC 08F7

For example: Select Destination # 1 to show Source #1~8

The IR Data Code list :

Destination # 1, Source #1 23DC 10EF 23DC 01FE

Destination # 1, Source #2 23DC 10EF 23DC 02FD

Destination # 1, Source #3 23DC 10EF 23DC 03FC

Destination # 1, Source #4 23DC 10EF 23DC 04FB

Destination # 1, Source #5 23DC 10EF 23DC 05FA

Destination # 1, Source #6 23DC 10EF 23DC 06F9

Destination # 1, Source #7 23DC 10EF 23DC 07F8

Destination # 1, Source #8 23DC 10EF 23DC 08F7

RS-232 SERIAL INTERFACE

RS-232 SERIAL INTERFACE CONNECT A PC OR CONTROL SYSTEM. VERSION COMPATIBLE V2.0.1

For a complete list of commands, please reference external document extended RS-232 Protocol Instruction Manual.

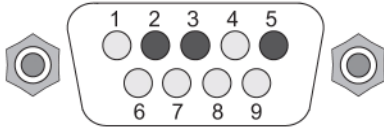

RS-232 SERIAL INTERFACE

| Pin | RS-232 | Definition |
|-----|--------|-------------|
| 1 | ----- | Not used |
| 2 | TX | Transmitter |
| 3 | RX | Receiver |
| 4 | ----- | Not used |
| 5 | GND | Ground |
| 6 | ----- | Not used |
| 7 | ----- | Not used |
| 8 | ----- | Not used |
| 9 | ----- | Not used |

RS-232 PROTOCOL COMMANDS (RS-232 Control driver V2.0.1)

The Shinybow switcher can be controlled via the RS-232 serial control port to allow for interfacing to a PC, or similar third party control system.

The serial communication parameters are 9600 baud, 8 bit, No Parity and 1 stop bit - this is often referred to as 9600 8N1. When the unit recognizes a complete command it will perform the requested action - there is no delimiter character required.

For a complete list of commands, please reference external document extended RS-232 Protocol Instruction Manual.





EDID FUNCTION

EDID FUNCTION SETUP



| EDID Setup | To change the EDID setup |
|---|--|
| Step 1 . Press the EDID button | The display will show the currently selected EDID mode |
| Step 2 . Press SOURCE #1 or #2 button row | The button will flash blue and the display will show the current Embedded EDID Status. |
| Step 3 . Press the ENTER button | To set EDID mode. The switcher will return to operation mode. |
| Operation will abort if no keys are pressed within 5 seconds. | |

| Embedded EDID modes | Total 8 EDID Modes |
|---|--|
| <p>Embedded EDID setup</p> <p>Press EDID > SOURCE > ENTER</p> <p>SOURCE #1 or SOURCE #2</p>  | <p>To select Embedded EDID mode or LEARNING mode. Press EDID button : The LCM will show the current EDID status.</p> <p>Repeatedly depressing the source 1 button will cycle up thru the options. Repeatedly depressing the source 2 button will cycle down thru the options.</p> <p>Embedded EDID :</p> <ul style="list-style-type: none"> Mode 1 : FSS Mode 2 : H24-3D Mode 3 : H24M-3D Mode 4 : H36-3D Mode 5 : H36M-3D Mode 6 : DVI 1280x1024-60Hz Mode 7 : DVI 1920x1200-60Hz Mode 8 : AUTO |



EDID FUNCTION : 8X EMBEDDED EDID MODES

| EDID Function | 8x Embedded EDID Modes |
|---|---|
| <p>Mode 1. FSS (Fast Speed Start)</p>  | <p>Video Support : All resolutions up to and including 1080p.</p> <p>Automatic capture of the most suitable EDID from Destination to Source.</p> |
| <p>Mode 2. H24-3D (1080p-24 bits)</p>  | <p>Video Support : All resolutions up to and including 1080p.</p> <p>Audio Support : PCM 2CH</p> |
| <p>Mode 3. H24-3D-M (1080p-24bits)</p>  | <p>Video Support : All resolutions up to and including 1080p.</p> <p>Audio Support :</p> <p>MAT(MLP) 7.1CH, PCM 2CH, One Bit Audio 2CH, AC-3 5.1CH, DTS 5.1CH, PCM 7.1CH, Dolby Digital + 7.1CH, DTS-HD 7.1CH</p> |
| <p>Mode 4. H36 (1080p-36 bits)</p>  | <p>Video Support : All resolutions up to and including 1080p.</p> <p>Audio Support : PCM 2CH</p> |
| <p>Mode 5. H36-M (1080p-36 bits)</p>  | <p>Audio Support :</p> <p>MAT(MLP) 7.1CH, PCM 2CH, One Bit Audio 2CH, AC-3 5.1CH, DTS 5.1CH, PCM 7.1CH, Dolby Digital + 7.1CH, DTS-HD 7.1CH</p> |

EDID FUNCTION

| | |
|--|--|
| <p>Mode 6. 1280x1024-60Hz (DVI-D)</p>  | <p>DVI Support : DVI-D 1280x1024 60Hz</p> |
| <p>Mode 7. 1920x1200-60Hz (DVI-D)</p>  | <p>DVI Support : DVI-D 1920 x 1200 60Hz</p> |
| <p>Mode 8. AUTO <Default></p>  | <p>Video Support : All resolutions up to and including 1080p. All Outputs will be set to the highest common resolution of all connected display devices.</p> |

EDID FUNCTION FOR HDMI MATRIX SWITCHER

| RESET | EDID Return To Factory default |
|--|--|
| <p>How to RESET EDID mode</p> <p>Press EDID > SOURCE > ENTER</p>   | <p>To RESET the FACTORY DEFAULT (1080p-2CH).</p> <p>Press EDID button : The LCM will show the current EDID status.</p> <p>Press RECALL button : The LCM will show the RESET EDID.</p> <p>Press ENTER to confirm entries.</p> <p>The EDID will return to FSS mode and resolution 1080p-2CH.</p> |
| LEARNING EDID | Learning EDID from Destination to Source |
| <p>Learning EDID setup</p> <p>Press EDID > DESTINATION > SOURCE > ENTER</p>  | <p>.Press: EDID > DESTINATION #1 ></p> <p>Switcher will LEARN destination #1 EDID and pass the selected source.</p> |

NOTE : The already learned EDID cannot be modified. You can only rebuild a new Learning EDID.

For example; When the Source has “Learned” the EDID data from a destination, It will save that EDID information into EPROM and the EDID data cannot change.

Please select new learning destination to sources or change to one of the embedded EDID modes when you want to remove the learning EDID memory from EPRPM.

EDID FUNCTION

EDID FUNCTION FOR HDMI MATRIX SWITCHER

| | |
|---|--|
| Learning EDID Single to Single | Example : Learn Destination #2 EDID To Source #3. |
| Step 1 . Press EDID button | The button will flash blue and the display will show the current Embedded EDID Status. |
| Step 2 . Press the Destination #5 button row | Copy the Destination #5 Display EDID. |
| Step 3 . Press the Source #8 button row | Learning the Destination #5 EDID To Source # 8. |
| Step 4 . Press ENTER button | To confirm entries. |
| Learning EDID Single to multiple | Learning destination EDID link to the majority Sources |
| Step 1 . Press EDID button | The button will flash blue and the display will show the current Embedded EDID Status. |
| Step 2 . Press the Destinations #1~5 button row | Copy any 1~5 Destinations EDID. |
| Step 3 . Press the Source #1, #6,~#8 button row | Learning the Destination EDID link to source #1,#6,~#8 . |
| Step 4 . Press ENTER button | To confirm entries. |
| Learning EDID Single to ALL | Learning destination EDID link to All Sources |
| Step 1 . Press EDID button | The button will flash blue and the display will show the current Embedded EDID Status. |
| Step 2 . Press destination button 1 thru 5 | Learning anyone 1~5 Destination EDID to all sources. |
| Step 3 . Press ALL button | Learning selected destination EDID to all sources. |
| Step 4 . Press ENTER button | To confirm entries. |
| EDID status | To view the current EDID status. |
| Step 1 . Press EDID button | The button will flash blue and the display will show the current Embedded EDID Status. |
| Step 2 . Press EDID button | To exit. |
| How to setup FSS® Function | Fast Speed Start® |
| Step 1 . Press the Destination #1~5 button row Then Press the Source #1~8 button row | To setup and Install all devices. |
| Step 2 . Press EDID button | Select a optimum status of Embedded EDID mode. |
| Step 3 . Press ENTER button | To confirm entries. |
| Step 4 . Press EDID button | To select the EDID FSS® mode. |
| Step 5 . Press ENTER button | To confirm entries. |
| LEARNING EDID definition | Learning EDID from Destination to Source |
| 1. Switcher will LEARN destination EDID and pass the selected source. | |
| 2. To set up learning between a single destination and single source: Press EDID button > Press Destination 1 thru 5 > Press Source 1 thru 8 > Press ENTER to confirm. Switcher will learn destination EDID to source device. | |
| 3. To set up learning between a single destination and Multiple sources: Press EDID button > Press Destination 1 thru 5 > Press the majority Sources 1 thru 8 > Press ENTER . Switcher will learn single destination EDID to many source devices. | |
| 4. How to Learning single destinations with all sources. Press EDID button > Press ALL button > Press ENTER to confirm. | |
| Auto mode definition | Common Resolution and Audio |
| Switcher will find highest common Resolution and Audio from all destination EDID to link Source. Example for single source: Destination > press #1 and then Source > press #1 Destination device #1 will set to the highest common resolution and Audio of source #1 Example for multiple sources Destination device #1, #2, #3 will be set to the highest common resolution and Audio available and source device #1 will output this same resolution. | |

TYPICAL APPLICATION

INSTALLING DIAGRAM

Sample connection using IR Transmitters (SB-101) and IR Receiver (SB-100) with SB-6335T & SB-6335R to control a projector.

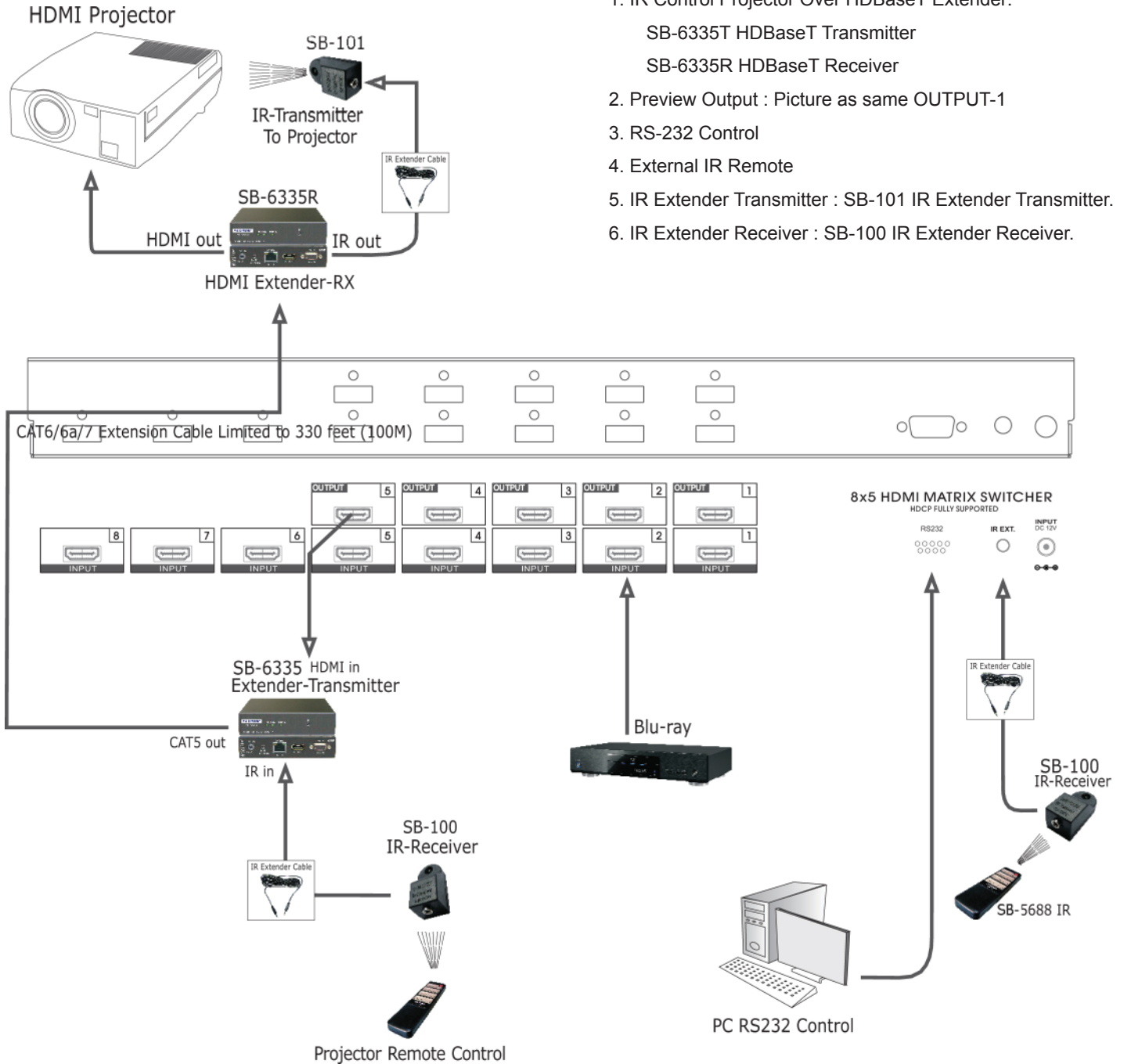

NOTE:

1. IR Control Projector Over HDBaseT Extender:
SB-6335T HDBaseT Transmitter
SB-6335R HDBaseT Receiver
2. Preview Output : Picture as same OUTPUT-1
3. RS-232 Control
4. External IR Remote
5. IR Extender Transmitter : SB-101 IR Extender Transmitter.
6. IR Extender Receiver : SB-100 IR Extender Receiver.

TYPICAL APPLICATION

INSTALLING DIAGRAM

Sample connection using IR Transmitters (SB-101) and IR Receivers (SB-100) with SB-6335T and SB-6335R to control a Satellite Receiver.

NOTE :

1. IR Control Satellite Receiver Over HDBaseT CAT5e/6/7 Extender from room:
 SB-6335T HDBaseT CAT5e/6/7 Transmitter
 SB-6335R HDBaseT CAT5e/6/7 Receiver
2. Audio Extractor To Recode Audio:
 SB-5609 HDMI Audio Extractor
3. Control HDMI ARC: SB-5610 ARC Control Box.
4. IR Extender Transmitter : SB-101 IR Extender Transmitter.
5. IR Extender Receiver : SB-100 IR Extender Receiver.

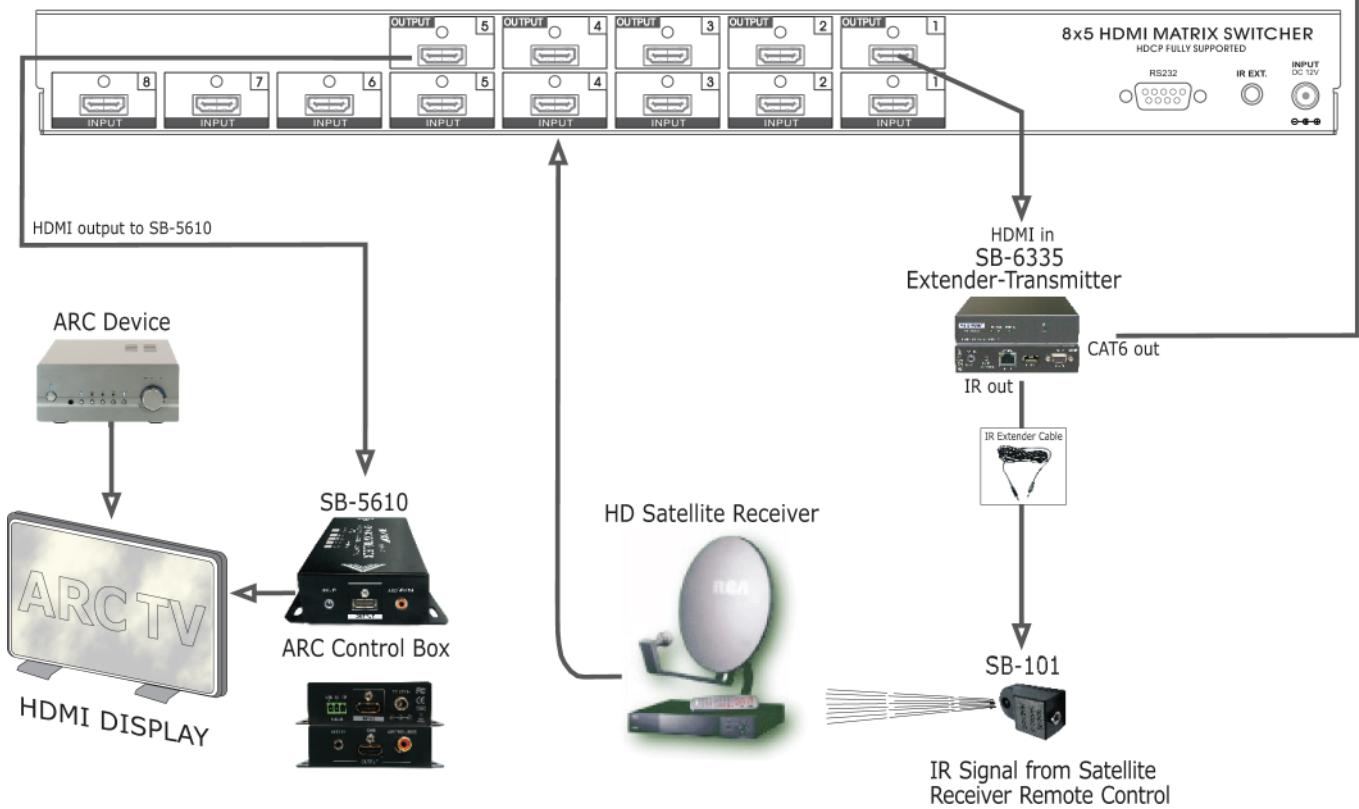
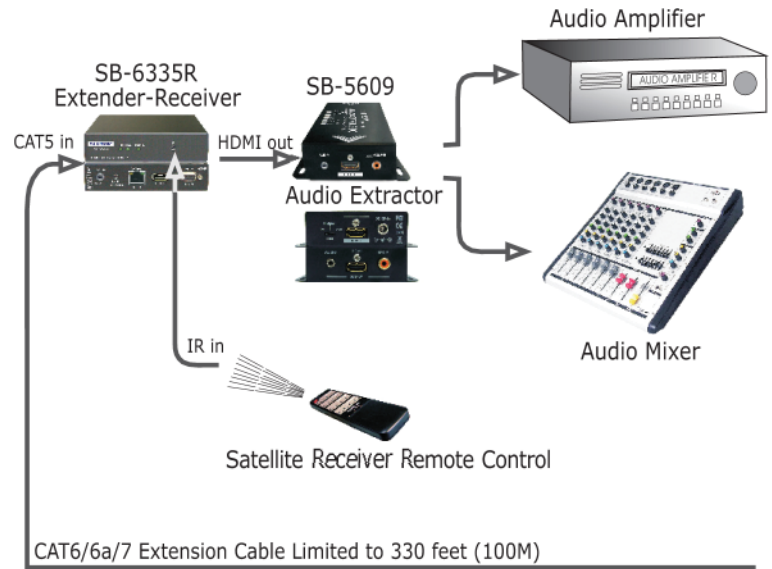

Support HDBaseT Extender by SB-6335T Transmitter and SB-6335R Receiver via CAT5e/6/7 cable

IR EXTENDER

REAR PANEL IR EXTENDER PORT

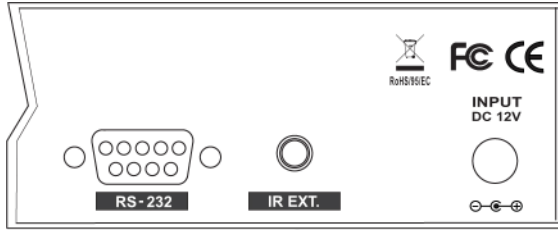

IR EXTENDER CONNECTION

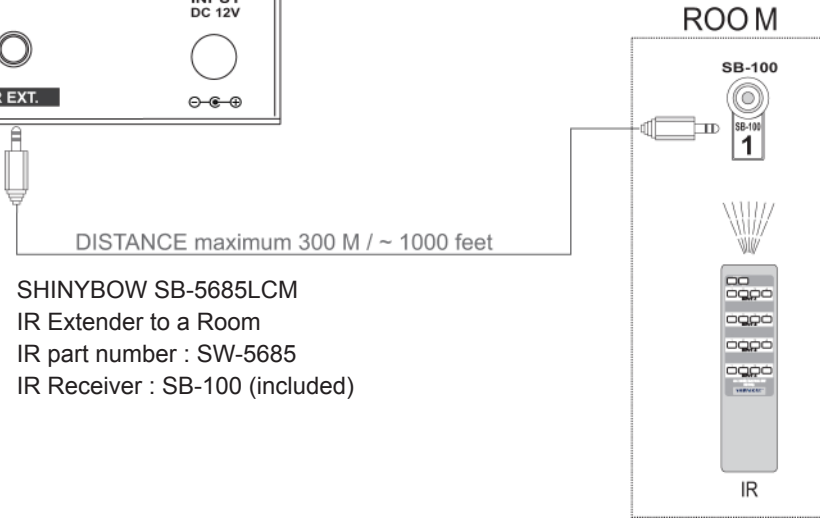

SHINYBOW SB-5685LCM
 IR Extender to a Room
 IR part number : SW-5685
 IR Receiver : SB-100 (included)

*** When you plug the External IR extender into the switcher, the front panel IR receiver remains active. ***

IR EXTENDER PACKAGE :

HOW TO SETUP THE IR EXTENDER COMPONENTS

Step 1

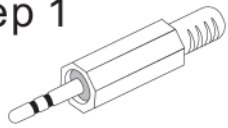

Tip:Signal
 Ring:VCC
 Sleeve:GND

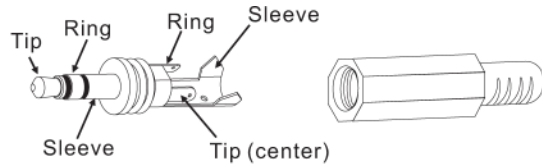

Step 2

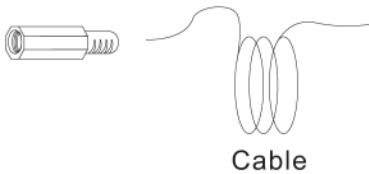

Step 3

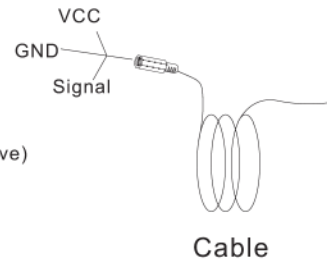
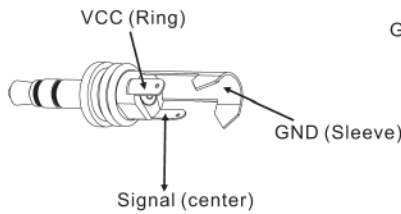

Switcher IR EXT. In

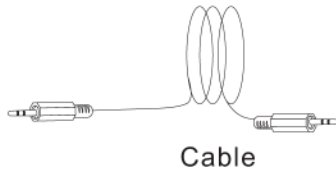
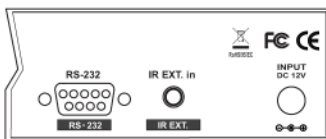

IR Receiver (SB-100)

LIMITED WARRANTY

PLEASE READ THE FOLLOWING TERMS AND CONDITIONS CAREFULLY BEFORE USING THIS HARDWARE, COMPONENTS AND SOFTWARE PROVIDED BY, THROUGH OR UNDER SHINYBOWUSA, INC (COLLECTIVELY, THE "PRODUCT"). By using installing or using the Product, you unconditionally signify your agreement to these Terms and Conditions. If you do not agree to these Terms and Conditions, do not use the Product and return the Product to SHINYBOWUSA, Inc. at the return address set forth on the Product's packing label at your expense. SHINYBOWUSA, Inc. may modify these Terms and Conditions at anytime, without notice to you.

RESTRICTIONS ON USE OF THE PRODUCT

It is your responsibility to read and understand the installation and operation instructions, both verbal and in writing, provided to you with respect to the Product. You are authorized to use the Product solely in connection with such instructions. Any use of the Product not in accordance with such instructions shall void any warranty pertaining to the Product. Any and all damages that may occur in the use of the Product that is not strictly in accordance with such instructions shall be borne by you and you agree to indemnify and hold harmless SHINYBOWUSA, Inc. from and against any such damage.

The Product is protected by certain intellectual property rights owned by or licensed to SHINYBOWUSA. Any intellectual property rights pertaining to the Product are licensed to you by SHINYBOWUSA, Inc. and/or its affiliates, including any manufacturers or distributors of the Product (collectively, "SHINYBOWUSA") for your personal use only, provided that you do not change or delete any proprietary notices that may be provided with respect to the Product.

The Product is sold to you and any use of any associated intellectual property is deemed to be licensed to you by SHINYBOWUSA for your personal use only. SHINYBOWUSA does not transfer either the title or the intellectual property rights to the Product and SHINYBOWUSA retains full and complete title to the intellectual property rights therein. All trademarks and logos are owned by SHINYBOWUSA or its licensors and providers of the Product, and you may not copy or use them in any manner without the prior written consent of SHINYBOWUSA, which consent may be withheld at the sole discretion of SHINYBOWUSA.

The functionality and usability of the Product is controlled by SHINYBOWUSA, Inc. from its offices within the State of Texas, United States of America. SHINYBOWUSA makes no representation that materials pertaining to the Product are appropriate or available for use in other locations other than the shipping address you provided with respect thereto. You are advised that the Product may be subject to U.S. export controls.

Disclaimers and Limitation of Liability

SHINYBOWUSA may change or modify the Product at any time, from time to time.

THE PRODUCT IS PROVIDED "AS IS" AND WITHOUT WARRANTIES OF ANY KIND EITHER EXPRESS OR IMPLIED. SHINYBOWUSA DOES NOT WARRANT OR MAKE ANY REPRESENTATIONS REGARDING THE USE OR THE RESULTS OF THE USE OF THE PRODUCT'S CORRECTNESS, ACCURACY, RELIABILITY, OR OTHERWISE.

SHINYBOWUSA has no duty or policy to update any information or statements pertaining to the Product and, therefore, such information or statements should not be relied upon as being current as of the date you use the Product. Moreover, any portion of the materials pertaining to the Product may include technical inaccuracies or typographical errors. Changes may be made from time to time without notice with respect to the Product.

TO THE FULLEST EXTENT PERMISSIBLE PURSUANT TO APPLICABLE LAW, SHINYBOWUSA DISCLAIMS ALL WARRANTIES, EXPRESS OR IMPLIED, INCLUDING, BUT NOT LIMITED TO IMPLIED WARRANTIES OF MERCHANTABILITY, FITNESS FOR A PARTICULAR PURPOSE AND NON-INFRINGEMENT. SHINYBOWUSA DOES NOT WARRANT THE ACCURACY, COMPLETENESS OR USEFULNESS OF ANY INFORMATION WITH RESPECT TO THE PRODUCT. SHINYBOWUSA DOES NOT WARRANT THAT THE FUNCTIONS PERTAINING TO THE PRODUCT WILL BE ERROR-FREE, THAT DEFECTS WITH RESPECT TO THE PRODUCT WILL BE CORRECTED, OR THAT THE MATERIALS PERTAINING THERETO ARE FREE OF DEFECTS OR OTHER HARMFUL COMPONENTS. SHINYBOWUSA WILL USE ITS REASONABLE EFFORTS TO CORRECT ANY DEFECTS IN THE PRODUCT UPON TIMELY WRITTEN NOTICE FROM YOU NOT TO EXCEED 10 BUSINESS DAYS AFTER RECEIPT BY YOU OF THE PRODUCT, BUT YOU (AND NOT SHINYBOWUSA) ASSUME THE ENTIRE COST OF ALL NECESSARY SERVICING, REPAIR AND CORRECTION THAT WAS CAUSED BY YOU UNLESS OTHERWISE AGREED TO IN A SEPARATE WRITING BY SHINYBOWUSA.

UNDER NO CIRCUMSTANCES, INCLUDING, BUT NOT LIMITED TO, NEGLIGENCE, SHALL SHINYBOWUSA BE LIABLE FOR ANY SPECIAL OR CONSEQUENTIAL DAMAGES THAT RESULT FROM THE USE OF, OR THE INABILITY TO USE THE PRODUCT IN ACCORDANCE WITH ITS SPECIFICATIONS, EVEN IF SHINYBOWUSA OR ITS REPRESENTATIVES HAVE BEEN ADVISED OF THE POSSIBILITY OF SUCH DAMAGES. IN NO EVENT SHALL SHINYBOWUSA'S TOTAL LIABILITY TO YOU FROM ALL DAMAGES, LOSSES, AND CAUSES OF ACTION (WHETHER IN CONTRACT, OR OTHERWISE) EXCEED THE AMOUNT YOU PAID TO SHINYBOWUSA, IF ANY, FOR THE PRODUCT.

END OF DOCUMENT

SHINYBOW™ USA

MULTIMEDIA AUDIO AND VISUAL
