

ANI-QUAD-MINI

HDMI 4x1 Quad Multi-Viewer w/ Seamless Switcher





SAFETY INFORMATION



1. To ensure the best results from this product, please read this manual and all other documentation before operating your equipment. Retain all documentation for future reference.
2. Follow all instructions printed on unit chassis for proper operation.
3. To reduce the risk of fire, do not spill water or other liquids into or on the unit, or operate the unit while standing in liquid.
4. Make sure power outlets conform to the power requirements listed on the back of the unit. Keep unit protected from rain, water and excessive moisture.
5. Do not attempt to clean the unit with chemical solvents or aerosol cleaners, as this may damage the unit. Dust with a clean dry cloth.
6. Do not use the unit if the electrical power cord is frayed or broken. The power supply cords should be routed so that they are not likely to be walked on or pinched by items placed upon or against them, paying particular attention to cords and plugs, convenience receptacles, and the point where they exit from the appliance.
7. Do not force switched or external connections in any way. They should all connect easily, without needing to be forced.
8. Always operate the unit with the AC ground wire connected to the electrical system ground. Precautions should be taken so that the means of grounding of a piece of equipment is not defeated.
9. AC voltage must be correct and the same as that printed on the rear of the unit. Damage caused by connection to improper AC voltage is not covered by any warranty.
10. Turn power off and disconnect unit from AC current before making connections.
11. Never hold a power switch in the "ON" position.
12. This unit should be installed in a cool dry place, away from sources of excessive heat, vibration, dust, moisture and cold. Do not use the unit near stoves, heat registers, radiators, or other heat producing devices.
13. Do not block fan intake or exhaust ports. Do not operate equipment on a surface or in an environment which may impede the normal flow of air around the unit, such as a bed, rug, carpet, or completely enclosed rack. If the unit is used in an extremely dusty or smoky environment, the unit should be periodically "blown free" of foreign dust and matter.
14. To reduce the risk of electric shock, do not remove the cover. There are no user serviceable parts inside. Refer all servicing to qualified service personnel. There are no user serviceable parts inside.
15. When moving the unit, disconnect input ports first, then remove the power cable; finally, disconnect the interconnecting cables to other devices.
16. Do not drive the inputs with a signal level greater than that required to drive equipment to full output.
17. The equipment power cord should be unplugged from the outlet when left unused for a long period of time.
18. Save the carton and packing material even if the equipment has arrived in good condition. Should you ever need to ship the unit, use only the original factory packing.
19. Service Information Equipment should be serviced by qualified service personnel when:
 - A. The power supply cord or the plug has been damaged.
 - B. Objects have fallen, or liquid has been spilled into the equipment.
 - C. The equipment has been exposed to rain
 - D. The equipment does not appear to operate normally, or exhibits a marked change in performance
 - E. The equipment has been dropped, or the enclosure damaged.

▶ CONTENTS

INTRODUCTION 1
 PACKAGE CONTENTS 1
 FEATURES 2
 SPECIFICATIONS 3
 OPERATION & FUNCTIONS 4
 CONNECT & OPERATE 6
 REMOTE CONTROL / PC GUI INTERFACE 5
 CONNECTION DIAGRAM 8
 RS-232 COMMANDS 9

DEAR CUSTOMER

Thank you for purchasing this product. For optimum performance and safety, please read these instructions carefully before connecting, operating or adjusting this product. Please keep this manual for future reference.

INTRODUCTION

The ANI-QUAD-MINI HDMI Quad Screen Multiviewer allows you to simultaneously display real-time HDMI/DVI video from (4) different sources on a single monitor. It is capable of displaying the video sources in quad, PiP or full screen mode. The audio/video output can be extended up to 250* feet away via a single CAT6/6a/7 cable.

PACKAGE CONTENTS

Before attempting to use this unit, please check the packaging and make sure the following items are contained in the shipping carton:

- HDMI Quad Multi-Viewer
- CAT5e/6 Receiver
- 2x Surface Mount brackets
- 12V/2.5A DC power adaptor
- 5V/1A DC power adaptor
- Remote Control
- 2x Wide-band IR Receiver
- 5x Wide-band IR Transmitter
- RS-232 Cable
- Operation Manual

Optional Rack Mount Bracket Available (ANI-QUAD-MINI-RM)

DOWNLOADS

- GUI Software: Download available from our website

www.a-neuvideo.com/shop/ANI-QUAD-MINI.html

SAFETY PRECAUTIONS

Please read all instructions before attempting to unpack, install or operate this equipment and before connecting the power supply. Please keep the following in mind as you unpack and install this equipment:

- Always follow basic safety precautions to reduce the risk of fire, electrical shock and injury to persons.
- To prevent fire or shock hazard, do not expose the unit to rain, moisture or install this product near water.
- Never spill liquid of any kind on or into this product.
- Never push an object of any kind into this product through any openings or empty slots in the unit, as you may damage parts inside the unit.
- Do not attach the power supply cabling to building surfaces.
- Use only the supplied power supply unit (PSU). Do not use the PSU if it is damaged.
- Do not allow anything to rest on the power cabling or allow any weight to be placed upon it or any person walk on it.
- To protect the unit from overheating, do not block any vents or openings in the unit housing that provide ventilation and allow for sufficient space for air to circulate around the unit.

DISCLAIMERS

The information in this manual has been carefully checked and is believed to be accurate. We assume no responsibility for any infringements of patents or other rights of third parties which may result from its use.

We assume no responsibility for any inaccuracies that may be contained in this document. We make no commitment to update or to keep current the information contained in this document.

We reserve the right to make improvements to this document and/or product at any time and without notice.

COPYRIGHT NOTICE

No part of this document may be reproduced, transmitted, transcribed, stored in a retrieval system, or any of its part translated into any language or computer file, in any form or by any means — electronic, mechanical, magnetic, optical, chemical, manual, or otherwise — without the express written permission and consent.

© Copyright 2015. All Rights Reserved.
 Version 2.0 MAY 2015

TRADEMARK ACKNOWLEDGMENTS

All products or service names mentioned in this document may be trademarks of the companies with which they are associated.

FEATURES

- 4x1 Quad Multi-viewer and seamless switch with multiplexed HDMI (4) inputs and (1) output
- Compliant with HDMI 1.3a, HDCP 1.2
- Supports scaler up, scaler down functions and digital audio formats LPCM/AC3/DTS
- Control provided with front panel buttons, IR remote, RS-232 and various third party controllers
- IR system allows for control of source at display end
- Allows HDMI Audio/Video and IR signals to be transmitted over a single CAT5e/6 cable
- Quad, Picture in Picture, and Full Screen display modes
- Quad Mode:
 - In quad mode, the screen is split into (4) fields of equal size each displaying the entire contents of (4) different video sources
 - Fluid, real-time video performance with 60 frames per second (fps) in all (4) quadrants
- Full Screen Mode:
 - In full screen mode, (1) of the (4) video sources is displayed in full screen size and maximum resolution
- Picture in Picture (PIP) Mode:
 - In PIP mode, the full screen display of (1) of the (4) video sources is accompanied by (3) small images (thumbnails) of the (3) other video sources on the right hand margin of the screen allowing simultaneous monitoring. Independent video in to video out resolution
- Supports HDTV resolutions up to 1080p and computer resolutions to 1920x1200
- HDMI features supported:
 - Inputs: 24, 30, and 36bit xvYCC, sRGB, and YCbCr
 - Outputs: 24 and 30bit sRGB
 - (4) channel non-mixing or (1) channel mixing stereo with 16, 20, or 24bit uncompressed PCM audio
 - Bandwidth up to 165 MHz
 - Inputs: 2.25 Gbps
 - Output: 2.0625 Gbps
- Fluid, real-time video performance with (60) frames per second (fps) in all (4) quadrants
- Switch audio independently of video from connected HDMI sources in Quad mode
- Control the multiviewer through front panel buttons, IR remote, or Graphical User Interface (GUI) via RS-232
 - Bi-directional IR control from multiviewer and remote unit locations
- Cascade multiviewers to display video from any number of video sources on (1) screen
 - Each unit in the cascade must be configured and controlled individually
 - Cascaded outputs can be extended using the remote unit as long as the combined total CAT6/6a/7 cable length between all levels of the cascade does not exceed 250 feet
- Adjust output video brightness, contrast, color, and sharpness
- Supports simultaneous local and remote HDMI output
 - Features coax SPDIF audio outputs at the multiviewer and receiver
- Built-in default EDID table
 - Supported output resolutions can be selected
- ARC (Audio Return Channel) support at the receiver unit via coax SPDIF output for speakers
 - Turn ARC on to play audio from an HDTV with ARC support to the connected speakers
 - Turn ARC off to play audio from the multiviewer source to the connected speakers

SPECIFICATIONS

- **Video Bandwidth:** 2.25Gbps
- **Input Ports:**
 - 4x HDMI (Female type)
 - 1x 3.5mm port for IR receiver
 - 1x RS-232
- **Output Ports:**
 - 1x HDMI (Female type)
 - 1x RCA
 - 1x RJ45 connector for CATx cable to remote unit
 - 1x UTP
 - 1x coax connector for local SPDIF audio
 - 4x 3.5mm ports for IR emitters
- **Audio Output:** PCM2, 5.1, 7.1CH, Dolby 5.1, DTS5.1
- **Input Resolution:** 480i60Hz,480p60Hz, 576i50Hz, 576p50Hz, 720p50/60Hz, 1080i50/60Hz, 1080p24/30/50/60Hz, 800x600@60, 1024x768@60, 1280x720@60, 1920x1080@60
- **Output Resolution:** 1080p, 1080i, 720p, 1024x768, 1360x768
- **Control:**
 - Infrared Remote Control:
 - IR control of multiviewer: Control with the included IR remote using the built-in IR receiver on the multiviewer or via an IR receiver connected to the remote unit
 - IR control of connected sources: Control with the source IR remote using the built-in IR receiver on the multiviewer or via an IR transmitter connected to the multiviewer and an IR receiver connected to the remote unit
 - IR control of connected display: Control the remote display with the display IR remote via the IR receiver on the multiviewer and an IR transmitter connected to the remote unit
 - Front Panel Interface
 - RS-232 Control
- **ESD Protection: Human Body model:** ±8 kV (air-gap discharge)
±4 kV (contact discharge)
- **Power Supply:** 100 to 240VAC@50 or 60Hz via AC adapter (US/EU standards, CE, FCC, RoHS)
- **Dimensions (WxDxH):** 4.6 x 9.8 x 1.3 in (118x250x32 mm)
- **Weight:** 1.65 lb/750g
- **Chassis Material:** Metal
- **Silkscreen Color:** Black
- **Operating Temperature:** 0°C~40°C/ 32°F~104°F
- **Storage Temperature:** -20°C~60°C/-4°F~140°F
- **Relative Humidity:** 20~90% RH (non-condensing)
- **Power Consumption:** 10W

Cable	Distance	Max Resolution
CAT6 Standard UTP	90 ft	1080p/60Hz
CAT6 Solid UTP*	125 ft	1080p/60Hz
	250 ft	1080i/60Hz / 720p/60Hz
CAT6a/7 Solid UTP/STP*	250 ft	1080p/60Hz

As product improvements are continuous, specifications are subject to change without notice.

FRONT PANEL

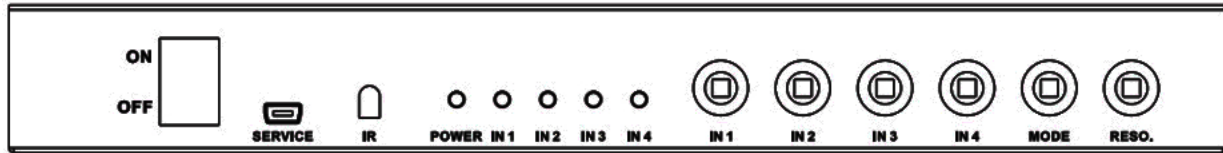

- 1 **ON/OFF:** Power on/off switch.
- 2 **SERVICE:** For factory use only.
- 3 **IR :** Remote control receiver window.
- 4 **POWER LED:** This red LED illuminates when the device is connected to the power supply.
- 5 **IN1, 2, 3, 4 LED:** These red LED illuminates when the output has selected the corresponding input.
- 6 **INPUT BUTTON:** Press this button to select the Input source.
- 7 **MODE BUTTON:** Press this button to cycle thru the different view display modes.
- 8 **RESO BUTTON:** Press this button to cycle thru the HDMI output resolutions.

BACK PANEL

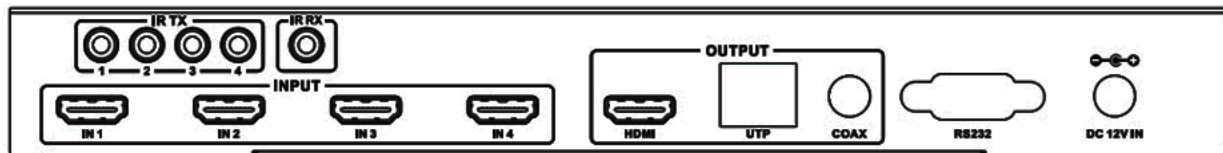

- 1 **INPUT:** This slot is where you connect the HDMI source output from DVD, PS3, Set-top Box and Note Book.
- 2 **OUTPUT:** The HDMI is where you connect the HDTV or monitor with HDMI cable for input source display. The UTP port connect to CAT Receiver by CAT5e/6 cable for signal extend. The Coax is where you connect to the amplifier with coaxial cable.
- 3 **IR RX:** Connect to the IR Receiver for IR signal reception. Ensure that remote being used is within the direct line-of-sight of the IR receiver.
- 4 **IR TX:** Connect the IR Blaster cable included in the package for IR signal transmission. Place the IR blaster in direct line-of-sight of the equipment to be controlled.
- 5 **RS-232:** Connect the RS-232 port to the PC or notebook by RS-232 Cable.
- 6 **DC 12V:** Plug the 12V DC power supply into the unit and connect the adaptor to AC wall outlet.

CAT RECEIVER

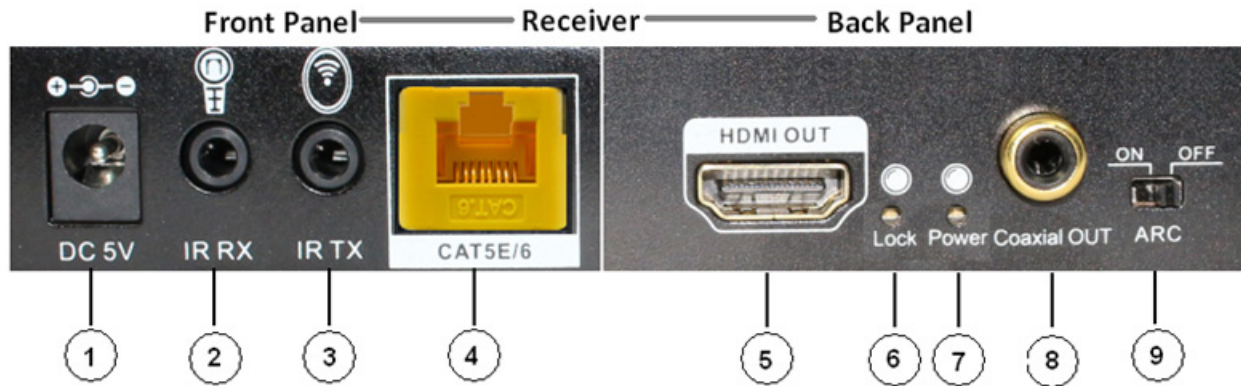

- 1 **DC 5V:** Connect from 5V DC power supply into the unit and connect the adaptor to an AC outlet.
- 2 **IR RX:** Connect to the IR Receiver for IR signal reception. Ensure that remote being used is within the direct line-of-sight of the IR receiver.
- 3 **IR TX:** Connect the IR Blaster cable included in the package for IR signal transmission. Place the IR blaster in direct line-of-sight of the equipment to be controlled.
- 4 **CAT5e/6:** Connect the CAT input of the receiver with the CAT output of the transmitter with CAT5e/6 cable.
- 5 **HDMI OUT:** This slot is to connect the HDMI input port of your display such as an HDTV.
- 6 **LOCK LED:** This LED will illuminate when the HDMI signal from the transmitter is stable.
- 7 **POWER LED:** This LED will illuminate when the device is connected with power supply.
- 8 **COAXIAL OUT:** This slot is where you connect to the audio amplifier with coaxial cable.
- 9 **ARC :** Switch the ARC switcher will open or close the ARC function.

ARC Function: If you need use ARC, your HDTV must support this function. When you open the ARC function, the coaxial of the receiver will output the HDTV current display content audio signal. Otherwise will output the HDMI source (DVD, set-top-box, etc.) audio signal.

CONNECT AND OPERATE

1. Connect the signal sources such as Blu-Ray Player, Play Station 3, audio/video receiver, satellite receivers and computers equipped with HDMI output interfaces with a short high-speed HDMI cable to the HDMI Switcher inputs.
2. Connect the HDMI output of the HDMI Switcher to a high-definition display device such as HD-LCD, HD-DLP and HD projectors with HDMI input interfaces. Use high-speed HDMI cables that are recommended for the distances that are required for each connection.
3. The Switcher is powered by an external power supply which is included. Connect power first to the source, then to the Switcher and then to HDTV or projector.
4. The input source can be controlled from the display. This is accomplished by using an optional IR Receiver pigtail pointing away from the display(s), which can be connected with an optional HDMI IR Adapter, and inserted between HDMI cable connector and display with the toggle switcher at the "IR" position. The IR Transmitter pigtail is used to connected to the switcher and pointed to the source(s). The switcher also have a capability of being controlled via Remote control.

WIDEBAND IR (30KHZ--60KHZ) INTRODUCTION

IR RECEIVER

IR BLASTER

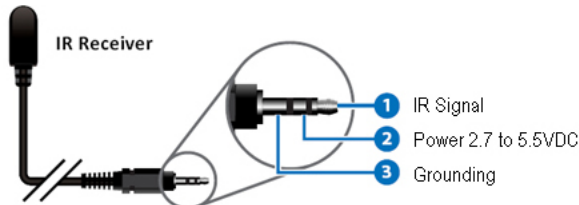
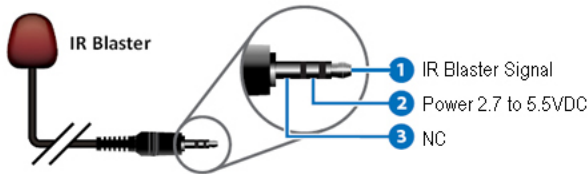

IR BLASTER (TX): To control the source: Plug IR Blaster into IR TX port of transmitter unit. Place blaster in front of the IR eye of the source.

IR RECEIVER (RX): To control the source: Plug IR Receiver into IR RX port of receiver unit. Place receiver at or near display.

DETAIL DESCRIPTION OF DISPLAY MODES

The quad multi-viewer has (3) display modes.

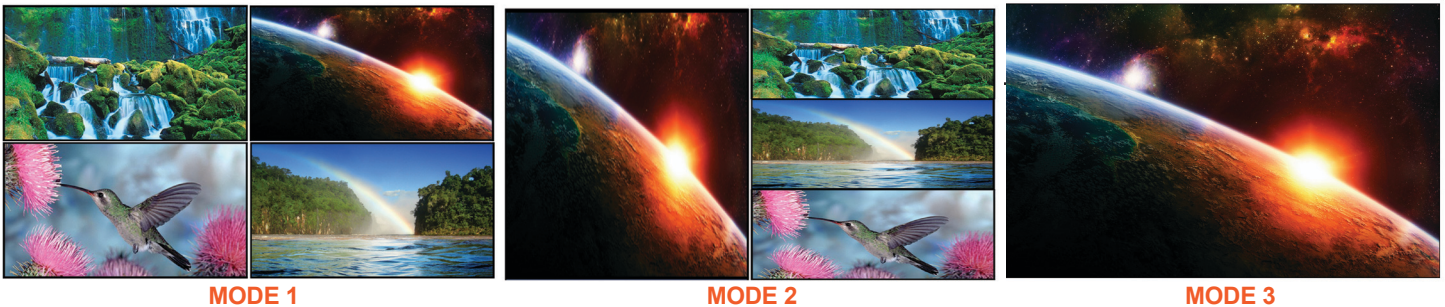

MODE1: The quad multi-viewer divides the (4) HD inputs into the same size displays on (1) screen. Switch the inputs using the buttons on the front panel or IR remote, and the HDMI output audio will correspond to the selected input source.

MODE2: The quad multi-viewer divides the (4) HD inputs into (1) large and (3) smaller picture displays on (1) screen. Switch the inputs using the buttons on front panel or IR remote, and the bigger picture will correspond to the selected input source. The HDMI output audio follow the bigger picture source.

MODE3: The quad multi-viewer will separate and display the (4) HD inputs individually and become a seamless switcher.

REMOTE CONTROL

- 1 **Input Select Button:** The quad multi-viewer will select the corresponding input source. The front panel LED will indicate the selected input source status.
- 2 **Mode Select Button:** The quad multi-viewer will select the corresponding mode, see the detail description.
- 3 **Resolution Button:** The HDMI will output different resolutions, 1080p,1080i, 720p,1024x768,1360x768. The F1, F2 buttons expand for user defined fuction. Press the Reset button, the quad multi-viewer will reset to factory state.
- 4 **Picture Button:** These buttons can adjust the display picture contrast, brightness, color and sharpness.

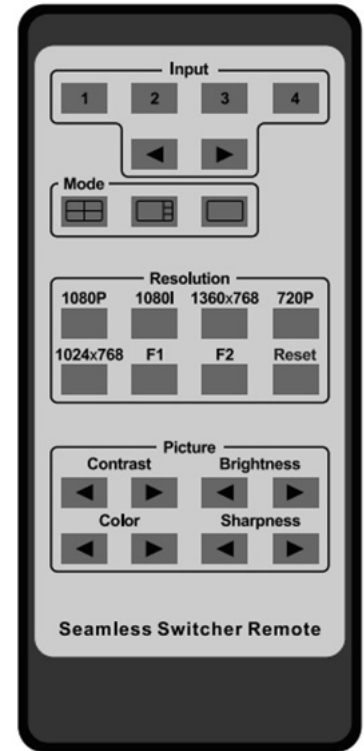

PC GUI INTERFACE

INSTALLATION: Download the GUI software from our site www.a-neuvideo.com/shop/ANI-QUAD-MINI.html

Just use a cable to connect the PC via RS-232 port and copy “Quad multi-viewer.exe” to your PC to complete installation.

PREPARATION:

1. Connect PC and multi-viewer by RS-232 cable (headers of both sides of cable should be FEMALE)
2. Power-up multi-viewer
3. Double click Quad multi-viewer.exe icon to run it

SET UP:

1. Select PC connect COM port. Click to connect or disconnect PC and multi-viewer.
2. Select the HDMI output resolution.
3. Select the input source.
4. Select the output mode, see the detail description. Adjust the HDMI output picture quality.
6. Display or hidden the OSD menu.
7. FW upgrade part: Click to open Firmware. Then click the UPGRADE button. the new firmware will auto download to the multi-viewer and restart it.
8. Press the RESET button. The quad multi-viewer will reset to factory state.

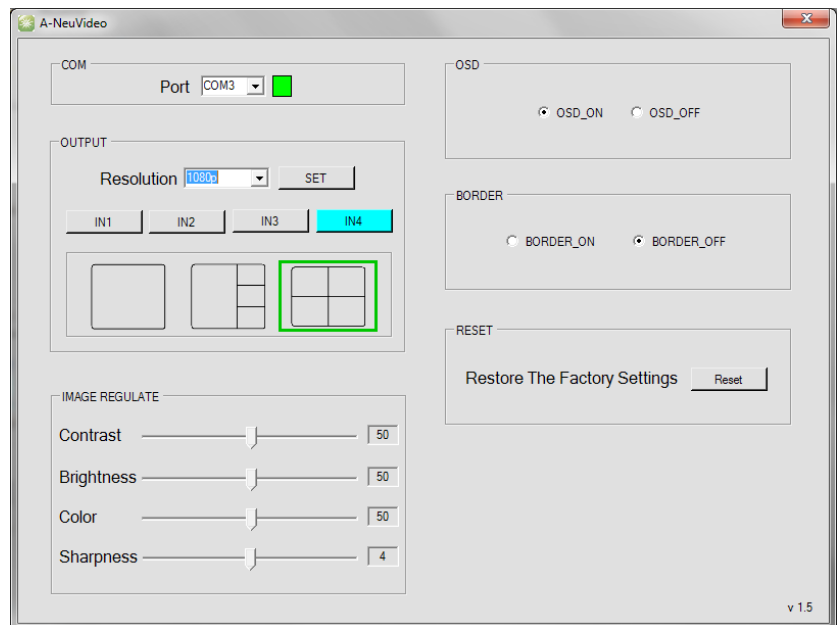

DIAGRAM

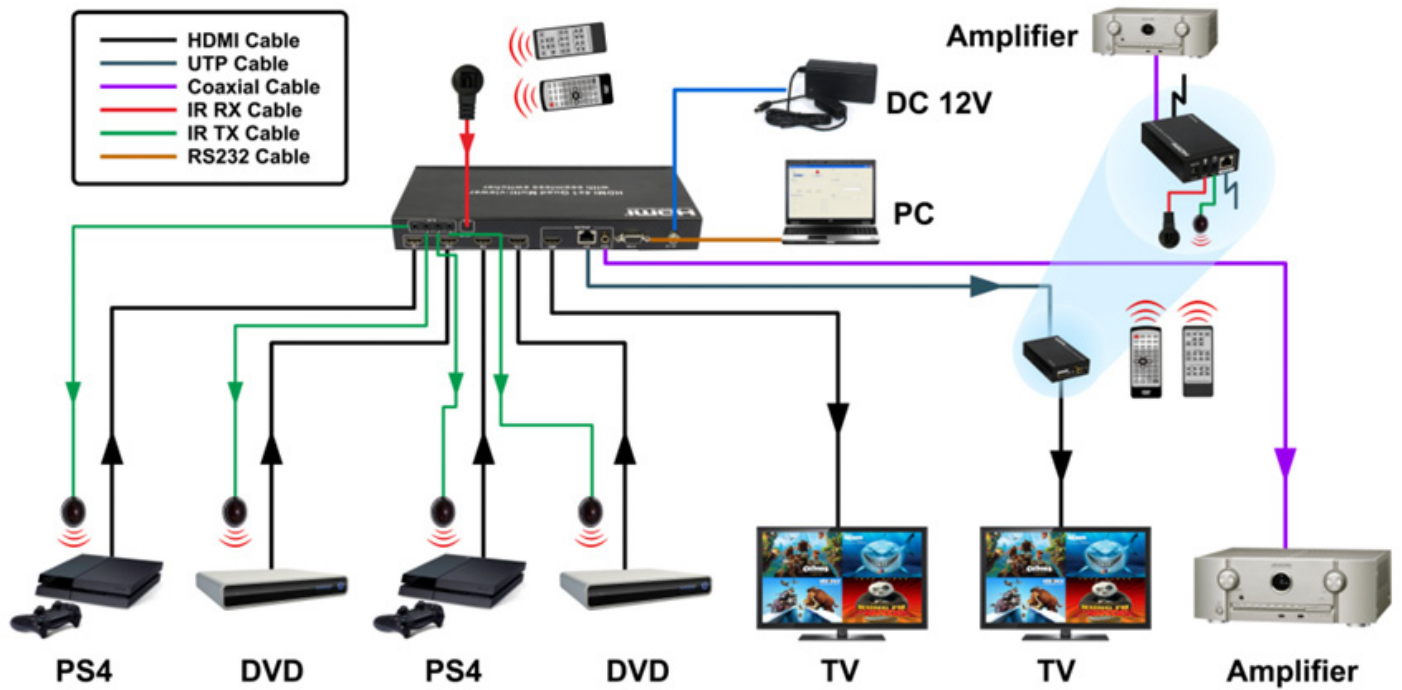

OPTIONAL RACK MOUNT BRACKET



MODEL NO.: ANI-QUAD-MINI-RM

RS-232 SERIAL INTERFACE FOR CONNECTION TO A PC OR 3RD PARTY CONTROLLER

1. Transmission rate: 115200bps
 2. Data format: 8 data bits, No parity, 1 start bit and 1 stop bit
 3. Flowing control: None
- Also know as 115200,8,n,1

RS-232 Pin Diagram

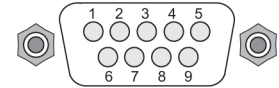

RS-232 CONFIGURATION

RS-232 cable is a straight thru cable and not null-modem

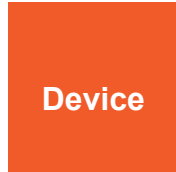

Definition	Pin		Pin	Definition
	1		1	DCD
TX	2		2	RX
RX	3		3	TX
	4		4	DTR
GND	5		5	GND
	6		6	DSR
	7		7	RTS
	8		8	CTS
	9		9	RI



Data String Format

The data string must conclude with a period "." (without the quotes).
All text is full ASCII Code and is NOT case sensitive.

COMMANDS

COMMAND	AUCTION	ANI-QUAD-MIN RETURNS	OPTIONS
Resolution1.	Change resolution to 1080P	Resolution : 1080P/60	
Resolution2.	Change resolution to 720P	Resolution : 720P/60	
Resolution3.	Change resolution to 1080I	Resolution : 1080I/60	
Resolution4.	Change resolution to 1360x768	Resolution : 1360x768/60	
Resolution5.	Change resolution to 1024x768	Resolution : 1024x768/60	
IN1.	Select input 1	Input 1 select	
IN2.	Select input 2	Input 2 select	
IN3.	Select input 3	Input 3 select	
IN4.	Select input 4	Input 4 select	
Mode1.	Select mode QUAD	Mode:QUAD	
Mode2.	Select mode PIP	Mode:PIP	
Mode3.	Select mode FULL	Mode:FULL	
OSDON.	ENABLE OSD	OSD ON	
OSDOFF.	DISABLE OSD	OSD OFF	
BorderON.	ENABLE Color Border	Border ON	
BorderOFF.	DISABLE Color Border	Border OFF	
Contrastxx.	Setting Contrast 50	Contrast : 50	X= - 00 to 99
Brightnessxx.	Setting Brightness 50	Brightness : 50	X= - 00 to 99
Colorxx.	Setting Color 50	Color : 50	X= - 00 to 99
Sharpnessx.	Setting Sharpness 0	Sharpness : 0	X= - 0 to 8
Version.	Check software Version	V 1.7	
Restore.	Factory Reset	Factory init	

PLEASE READ THE FOLLOWING TERMS AND CONDITIONS CAREFULLY BEFORE USING THIS HARDWARE, COMPONENTS AND SOFTWARE PROVIDED BY, THROUGH OR UNDER A-NeuVideo, INC (COLLECTIVELY, THE "PRODUCT"). By using installing or using the Product, you unconditionally signify your agreement to these Terms and Conditions. If you do not agree to these Terms and Conditions, do not use the Product and return the Product to A-NeuVideo, Inc. at the return address set forth on the Product's packing label at your expense. A-NeuVideo, Inc. may modify these Terms and Conditions at anytime, without notice to you.

RESTRICTIONS ON USE OF THE PRODUCT

It is your responsibility to read and understand the installation and operation instructions, both verbal and in writing, provided to you with respect to the Product. You are authorized to use the Product solely in connection with such instructions. Any use of the Product not in accordance with such instructions shall void any warranty pertaining to the Product. Any and all damages that may occur in the use of the Product that is not strictly in accordance with such instructions shall be borne by you and you agree to indemnify and hold harmless A-NeuVideo, Inc. from and against any such damage.

The Product is protected by certain intellectual property rights owned by or licensed to A-NeuVideo. Any intellectual property rights pertaining to the Product are licensed to you by A-NeuVideo, Inc. and/or its affiliates, including any manufacturers or distributors of the Product (collectively, "A-NeuVideo") for your personal use only, provided that you do not change or delete any proprietary notices that may be provided with respect to the Product.

The Product is sold to you and any use of any associated intellectual property is deemed to be licensed to you by A-NeuVideo for your personal use only. A-NeuVideo does not transfer either the title or the intellectual property rights to the Product and A-NeuVideo retains full and complete title to the intellectual property rights therein. All trademarks and logos are owned by A-NeuVideo or its licensors and providers of the Product, and you may not copy or use them in any manner without the prior written consent of A-NeuVideo, which consent may be withheld at the sole discretion of A-NeuVideo.

The functionality and usability of the Product is controlled by A-NeuVideo, Inc. from its offices within the State of Texas, United States of America. A-NeuVideo makes no representation that materials pertaining to the Product are appropriate or available for use in other locations other than the shipping address you provided with respect thereto. You are advised that the Product may be subject to U.S. export controls.

Disclaimers and Limitation of Liability

A-NeuVideo may change or modify the Product at any time, from time to time.

THE PRODUCT IS PROVIDED "AS IS" AND WITHOUT WARRANTIES OF ANY KIND EITHER EXPRESS OR IMPLIED. A-NEUVIDEO DOES NOT WARRANT OR MAKE ANY REPRESENTATIONS REGARDING THE USE OR THE RESULTS OF THE USE OF THE PRODUCT'S CORRECTNESS, ACCURACY, RELIABILITY, OR OTHERWISE.

A-NeuVideo has no duty or policy to update any information or statements pertaining to the Product and, therefore, such information or statements should not be relied upon as being current as of the date you use the Product. Moreover, any portion of the materials pertaining to the Product may include technical inaccuracies or typographical errors. Changes may be made from time to time without notice with respect to the Product.

TO THE FULLEST EXTENT PERMISSIBLE PURSUANT TO APPLICABLE LAW, A-NEUVIDEO DISCLAIMS ALL WARRANTIES, EXPRESS OR IMPLIED, INCLUDING, BUT NOT LIMITED TO IMPLIED WARRANTIES OF MERCHANTABILITY, FITNESS FOR A PARTICULAR PURPOSE AND NON-INFRINGEMENT. A-NEUVIDEO DOES NOT WARRANT THE ACCURACY, COMPLETENESS OR USEFULNESS OF ANY INFORMATION WITH RESPECT TO THE PRODUCT. A-NEUVIDEO DOES NOT WARRANT THAT THE FUNCTIONS PERTAINING TO THE PRODUCT WILL BE ERROR-FREE, THAT DEFECTS WITH RESPECT TO THE PRODUCT WILL BE CORRECTED, OR THAT THE MATERIALS PERTAINING THERETO ARE FREE OF DEFECTS OR OTHER HARMFUL COMPONENTS. A-NEUVIDEO WILL USE ITS REASONABLE EFFORTS TO CORRECT ANY DEFECTS IN THE PRODUCT UPON TIMELY WRITTEN NOTICE FROM YOU NOT TO EXCEED 10 BUSINESS DAYS AFTER RECEIPT BY YOU OF THE PRODUCT, BUT YOU (AND NOT A-NEUVIDEO) ASSUME THE ENTIRE COST OF ALL NECESSARY SERVICING, REPAIR AND CORRECTION THAT WAS CAUSED BY YOU UNLESS OTHERWISE AGREED TO IN A SEPARATE WRITING BY A-NEUVIDEO.

UNDER NO CIRCUMSTANCES, INCLUDING, BUT NOT LIMITED TO, NEGLIGENCE, SHALL A-NEUVIDEO BE LIABLE FOR ANY SPECIAL OR CONSEQUENTIAL DAMAGES THAT RESULT FROM THE USE OF, OR THE INABILITY TO USE THE PRODUCT IN ACCORDANCE WITH ITS SPECIFICATIONS, EVEN IF A-NEUVIDEO OR ITS REPRESENTATIVES HAVE BEEN ADVISED OF THE POSSIBILITY OF SUCH DAMAGES. IN NO EVENT SHALL A-NEUVIDEO'S TOTAL LIABILITY TO YOU FROM ALL DAMAGES, LOSSES, AND CAUSES OF ACTION (WHETHER IN CONTRACT, OR OTHERWISE) EXCEED THE AMOUNT YOU PAID TO A-NEUVIDEO, IF ANY, FOR THE PRODUCT.