

I-Sniper Super Night Vision Outdoor Camera

INSTRUCTION MANUAL

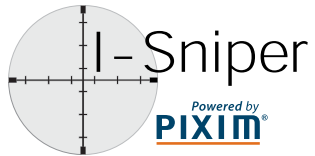

• **EL-2000**

Dear Customers!

By selecting this product, you have decided to use a professional device that guarantees highest quality and reliability. We would like to thank you very much for your confidence and kindly ask you to read the following instructions carefully before installation and operation in order to take full advantage of all quality features regarding this product.

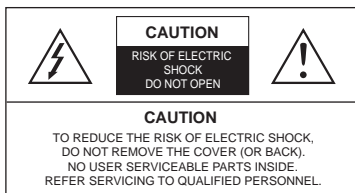

The lightning flash with an arrowhead symbol, within an equilateral triangle is intended to alert the user to the presence of non-insulated dangerous voltage within the product's enclosure that may be of sufficient magnitude to constitute a risk of electric shock to persons.



The exclamation point within an equilateral triangle is intended to alert the user to the presence of important operating and maintenance (servicing) instructions in the literature accompanying the appliance.

INFORMATION

This equipment has been tested and found to comply with limits for a Class A digital device, pursuant to part 15 of the FCC Rules. These limits are designed to provide reasonable protection against harmful interference when the equipment is operated in a commercial environment. This equipment generates, uses, and can radiate radio frequency energy and, if not installed and used in accordance with the instruction manual, may cause harmful interference to radio communications. Operation of this equipment in a residential area is likely to cause harmful interference in which case the user will be required to correct the interference at its own expense.

WARNING

Changes or modifications not expressly approved by the manufacturer could void the user's authority to operate the equipment.

CAUTION – To prevent electric shock and risk of the fire hazards

- Do NOT use power source other than that specified.
- Do NOT expose this appliance to rain or moisture.

This installation should be made by a qualified service person and should conform to all local codes.

Table of contents

1. Precautions -----	4
2. Limitation of liability -----	5
3. Disclaimer of warranty -----	5
4. Package -----	6
5. Main Features -----	7
6. Installation -----	8~9
6-1. Installation overview	
6-2. 3-Axis Adjustment	
6-3. Ext-Video	
6-4. Waterproof processing of cable end connection	
7. Tips for quick installation -----	10
7-1. Quick control to Zoom & Focus	
7-2. RS485 Connection	
8. Functions and operation -----	11~14
8-1. OSD Menu Tree	
8-2. Setting up the menu	
1. WDR CONTROL	
2. BLC	
3. AGC	
4. WHITE BALANCE	
5. FLUORESCENT	
6. ICR DVR TOOL	
7. RS-485..	
8. FLIP	
9. SAVE&EXIT	
10. DEFAULT	
11. CANCEL	
9. Troubleshooting -----	15~16
10. Dimension -----	16
11. Specification -----	17

1. Precautions

- Please read the manual carefully before the installation in order to set up the camera correctly and to obtain the best picture quality.
- Please keep the manual in good condition for your future reference and service application.
- Installation and services should be only carried out by an authorized personnel according to local safety regulations.
- If any liquid or solid matter gets into the housing, immediately disconnect the camera from power supply and have it checked by your authorized dealer before reusing.
- Avoid installing the camera at extremely hot or cold places.
- If you are not a certified person, never try to dismantle the camera. To avoid electric shock, never remove the screws or covers. There are no parts inside that need maintenance by the user. All maintenance should be carried out by qualified personnel.
- Avoid installing the camera at a place of high humidity.
- Avoid installing the camera at the place exposed to gas or oil.
- Keep the top glass of the lens always clean in order to obtain the best picture quality all the time. Be careful not to be stained by fingerprint.
- Please give a special attention to keep the unit from dangerous drop or external shock during the process of transportation or handling.
- Never try to touch the camera in wet hand. It may cause an electric shock.
- Do not expose the camera to radioactivity. It causes a serious damage on the Sensor.

2. Limitation of liability

This publication is provided "AS IS" without warranty of any kind, either express or implied, including but not limited to, the implied warranties of merchantability, fitness for any particular purpose, or non-infringement of the third party's right. This publication could include technical inaccuracies or typographical errors. Changes are added to the information herein, at any time, for the improvements of this publication and/or the corresponding product(s).

3. Disclaimer of warranty

In no event shall seller be liable to any party or any person, except for replacement or reasonable maintenance of the product, for the cases, including but not limited to below:

- (1) Any damage and loss, including without limitation, direct or indirect, special, consequential or exemplary, arising out of or relating to the product;
- (2) Personal injury or any damage caused by inappropriate use or negligent operation of the user;
- (3) Unauthorized disassemble, repair or modification of the product by the user;
- (4) Inconvenience or any loss arising when images are not displayed, due to any reason or cause including any failure or problem of the product;
- (5) Any problem, consequential inconvenience, or loss or damage, arising out of the system combined by the devices of third party.
- (6) Any claim or action for damages, brought by any person or organization being photogenic subject, due to violation of privacy with the result of that surveillance-camera's picture, including saved data, for some reason, becomes public or is used for the purpose other than surveillance.

4. Package



Camera x 1



manual x 1

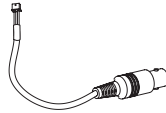

Extra video output cable
x 1



L- Wrench Ø4.0 x 1



Tapping screws x3



Plastic anchor x3

5. Main Features

- 1/3" I-Sniper PIXIM DPS image sensor
- 690TVL / 960H Effective Pixels
- Motorized Lens Control with built in button for local control and RS-485 for remote control through DVR
 - Quick, easy & accurate zoom and focus control
 - Quick and easy OSD Menu operation
- 2.8-12mm Motorized Vari-Focal Lens
- WDR (Wide Dynamic Range)
- 2D/3D Digital Noise Reduction
- Up to 150 ft IR True Night Time Viewing
- Intelligent IR Image Compensation
- Intelligent Functions
 - Highlight Eclipse Function
 - Privacy Masking
- RS-485 Interface (Pelco D)
- IP67 Weatherproof
- 12VDC / 24VAC Non-polarity power input

- Day / Night Comparison

By Day



By Night

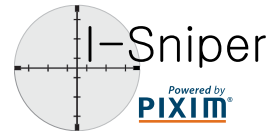

I-Sniper, the most accurate chip in the world, is an imaging solution created exclusively by Pixim for IC Realtime. I-Sniper cameras deliver clear, detailed images in real-world scenes, night and day, even under challenging, mixed lighting conditions. I-Sniper cameras have been custom tuned with camera settings specifically for ICRealtime's line of DVRs, resulting in 25-45% longer recording times vs. non-optimized 3rd party cameras.

6. Installation

6-1. Installation overview

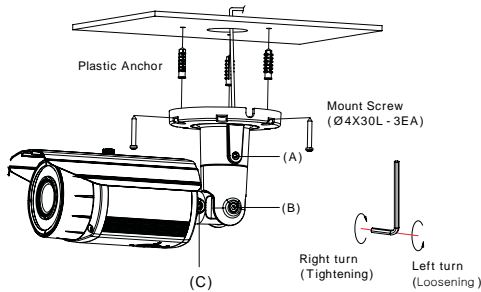
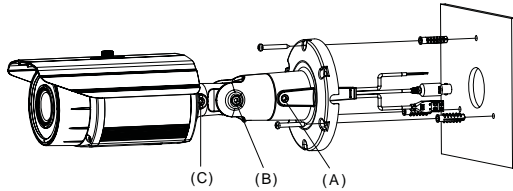

- ① Drill three screw holes on the ceiling plate to fix three anchors (supplied) in the holes.
- ② Fix the plastic anchors in the holes.
- ③ Position the mounting bracket on the screw points.
- ④ Fix the mounting bracket by tightening the screws.
- ⑤ Slightly loosen bolt (A), (B) then adjust TILT (180°) and PAN (360°) of the camera using a serration on the bracket and tighten the bolt firmly.
- ⑥ Slightly loosen bolt (C) then adjust ROTATION (360°) of the camera and tighten the bolt firmly

6. Installation

6-2. 3-Axis Adjustment

1. PAN 360°
2. TILT 180°
3. ROTATION 360°

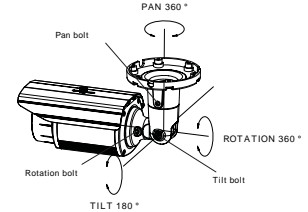

6-3. Ext-Video

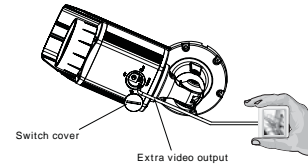

- How to use

- ① Take off switch cover located on the bottom of the camera body.
- ② Connect Extra video output to LCD Monitor as in the drawing.

6-4. Waterproof processing of cable end connection

Make sure to use a butyl tape. (Do not use a sealing material on those parts)

- ① It is useful to connect the cable ends from camera to the extension cable for waterproof.
- ② Connect and tape the power cables (Power-Power/Ground-Ground).
- ③ Bind the power cables together with the tape. When DC-Jack is used, tape the DC-DC joint.
- ④ Connect and tape the RS485 cables (RS485+—TRX+ /RS485— —TRX-)
- ⑤ Tape the BNC-BNC joint.

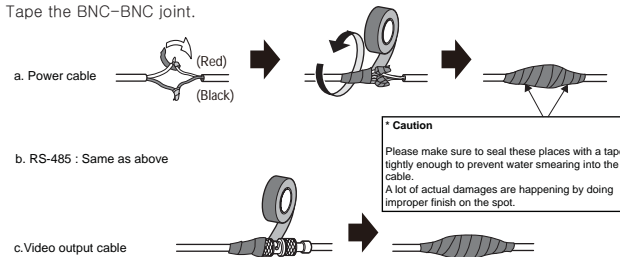

7. Tips for quick installation

7-1. Quick control to Zoom & Focus

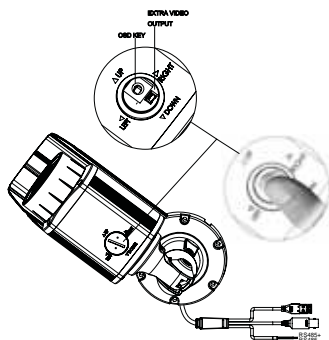

- Push up or down the Tact SW (OSD Key) by finger for a second
- Up → Zoom in
- Down ← Zoom out
- Left / Right ↔ Focus in/out

7-2. RS485 Connection

You can access to the OSD menu via remote controller or DVR as in the drawing.



8. Functions and operation

8-1. OSD Menu Tree

I-SNIPER					
WDR CONTROL	LOW	NORMAL	MIDDLE	HIGH	
BLC	OFF	ON			
AGC	LOW	NORMAL	HIGH		
WHITE BALANCE	ATW	AWB..			
FLUORESCENT	OFF	CRR	CRR2		
ICR DVR TOOL	OFF	EDGE SERIES	MAX SERIES	FLEX SERIES	ELITE SERIES
RS-485..	CAMERA #	PROTOCOL	BAUD RATE	RETURN.	
FLIP	OFF	BOTH	VERT	HORIZ	
SAVE&EXIT	DEFAULT	CANCEL			

8-2. Setting up the menu

- Press the Tact SW to enter <MAIN MENU>.
- Move the arrow to a specific menu by pushing the Tact SW up or down.
- Adjust the selected feature by pushing the Tact SW left or right

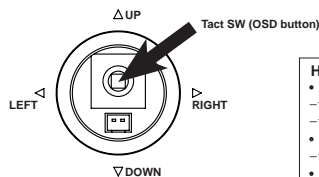
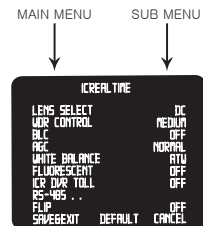

How to use OSD button (Tact SW)

- Press
 - to enter the menu
 - to save settings
- Push up or down
 - to select functions
- Push left or right
 - to adjust a level or mode of sub-menu

- When completed, move the arrow indicator to 'EXIT' and press the Tact SW to finish all settings.

8. Functions and operation

1.WDR(Wide Dynamic Range) CONTROL

Light level is controllable with provided easy-to-use OSD menu that enables the camera to be ideally Set up for the most of different levels of backlight or contrast lighting situations.

LOW : Dynamic range level similar to that of CCD cameras.
NORMAL : Suitable for most indoor scenes without windows or difficult lighting.
MIDDLE : Suitable for normal outdoor scenes and indoor scenes that include windows.
HIGH : Maximum setting for harsh outdoor scenes.



2.BLC(Back Light Compensation)

OFF : Highlights in image are prioritized.
ON : Shadows in image are prioritized.

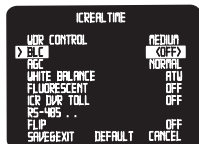

3.AGC(Auto Gain Control)

LOW : Low gain limit.
NORMAL : Normal gain limit.
HIGH : High gain limit.

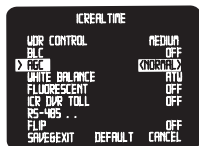

4.White Balance

The Automatic White Balance provides an extensive Range color temperature control that covers form 2,000°K to 11,000°K generating natural color image without Being red or blue in varying light conditions.

ATW : Auto-tracking white balance mode.
AWB : Set white balance now and lock it.

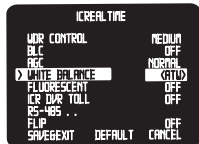

8. Functions and operation

5.Fluorescent

Color Rolling Reduction.

OFF : Not used CRR.

CRR : This color roll reduction mode will work with manual and auto-iris lenses. However, using it with auto-iris lenses typically results in noticeable levels of noise in shadows or dark areas in the image.

CRR2 : This color roll reduction mode works with auto-iris lenses only.
Noise levels are reduced in shadows or dark areas in the image compared to the noise levels present when using the CRR mode, but dynamic range is also reduced further.



6.ICR DVR TOOL

Ideal setting with IC Realtime DVR series.

OFF : Default Setting.
EDGE SERIES : EDGE series.
MAX SERIES : MAX series.
FLEX SERIES : FLEX series.
ELITE SERIES : ELITE series.



7.RS-485..

CAMERA# : Available to set up from 1 to 255.
PROTOCOL : Supports PELCO-D.
BAUD RATE : Select a baud rate.(2400, 4800, 9600, 19200)
RETURN. : Move to MAIN MENU.

*How to control OSD menu over RS485 :

- 1) Set communication speed on the camera to 9600bps.
- 2) Accord the ID of the camera with the of the DVR or PTZ controller.

The factory default ID of the camera is CAM1.

- 3) On the DVR or PTZ controller, press 95 then press PRESET or IRIS OPEN.(95+PRESET : Set Preset)
- 4) When the MAIN MENU pops up on the screen, move the cursor Using a joystick to the desired menu to control. When entering a Sub menu, press IRIS OPEN momentarily.

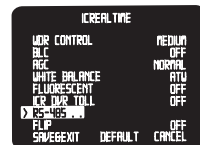

8. Functions and operation

8.FLIP

Adjustable to OFF, HORIZ, VERT, BOTH.

* OFF : Normal image



* HORIZ : Mirror image



* VERT : Vertical Reversal Image

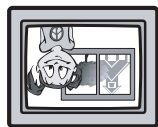

* BOTH : Flip over image

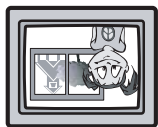

9.SAVE&EXIT

Saves the current settings and exits the menu.



10.DEFAULT

All the settings will be restored to the factory default.
RS-485.. settings are not initialized.

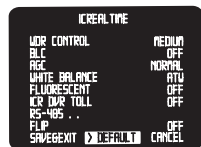

11.CANCEL

Not saves the current settings and exits the menu.



9. Troubleshooting

If there are problems in operating, please refer to the checklist below. If the problem persists, please contact the agent where this product is purchased.

Problems	Troubleshooting
Nothing appears on the screen.	<ul style="list-style-type: none"> Please check that the power cord and line connection between the camera and monitor are fixed properly. Please check that you have properly connected VIDEO cable to the camera VIDEO output jack.
The image on the screen is dim.	<ul style="list-style-type: none"> Is lens stained with dirt? Clean your lens with soft, clean cloth. Set the monitor to proper condition. If the camera is exposed to too strong light, change the camera position.
The image on the screen is dark.	<ul style="list-style-type: none"> Adjust the contrast feature of the monitor. If you have an intermediate device, set the 75Ω / Hi-Z properly (Please check the impedance)
The camera is not working properly, and the surface of the camera is hot.	<ul style="list-style-type: none"> Please check that you have properly connected the camera to an appropriate power source.
Color is not correct.	<ul style="list-style-type: none"> Please check the setting of WHITE BALANCE SETUP menu .

9. Troubleshooting

Problems	Troubleshooting									
RS-485 communication fails.	<ul style="list-style-type: none"> Please check the polarity between RS-485 Control Port and RS-485 cable. 									
	<table border="1"> <tr> <td>485 Control Board Connection Port</td> <td>RS-485 Control Port</td> </tr> <tr> <td>(+)CONNECTION TERMINAL(TRX+)</td> <td>485+</td> </tr> <tr> <td>(-)CONNECTION TERMINAL(TRX-)</td> <td>485-</td> </tr> </table>	485 Control Board Connection Port	RS-485 Control Port	(+)CONNECTION TERMINAL(TRX+)	485+	(-)CONNECTION TERMINAL(TRX-)	485-			
	485 Control Board Connection Port	RS-485 Control Port								
	(+)CONNECTION TERMINAL(TRX+)	485+								
	(-)CONNECTION TERMINAL(TRX-)	485-								
	<ul style="list-style-type: none"> Please check if the initial value of the RS-485 Communication setup matches between camera and OSD Controller or DVR. * RS-485 Communication establishment initial value 									
<table border="1"> <tr> <th>Item</th> <th>Camera ID</th> <th>BAUD RATE</th> <th>UART MODE</th> <th>RET PKT</th> </tr> <tr> <td>Initial value</td> <td>1</td> <td>9600</td> <td>8-NONE-1</td> <td>ENABLE</td> </tr> </table>	Item	Camera ID	BAUD RATE	UART MODE	RET PKT	Initial value	1	9600	8-NONE-1	ENABLE
Item	Camera ID	BAUD RATE	UART MODE	RET PKT						
Initial value	1	9600	8-NONE-1	ENABLE						
<ul style="list-style-type: none"> We recommend that you make ground connection between camera and controller for safe communication control. When RS-485 cable is not properly connected, Please reconnect and Reboot' is displayed. Then please turn off the power and connect the cable again. 										

10. Dimension (mm)

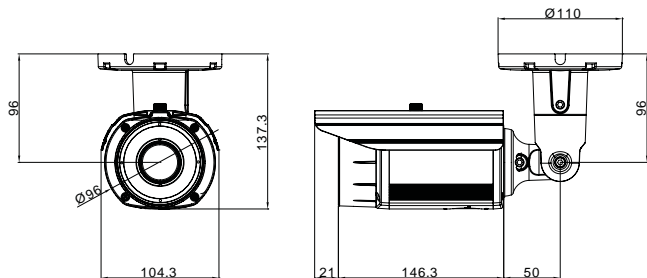

11. Specification

Model	EL-2000 (I-Sniper)
Image sensor	1/3" Pixim WDR digital imaging device
Effective Pixels	410,000 pixels 758(H)X540(V)
H.Resolution	690HTVL effective.
Synchronization	Internal
Video output	1.0Vp-p Composite 75 Ohms
S/N Ratio	50dB(AGC OFF, Weight ON)
Min.Illumination	0Lux
Shutter speed	1/25s ~ 1/30,720s(Global Shutter)
Gamma control	Standard $\gamma=0.45$
White Balance	2000°K ~ 11,000°K Auto. ATW / AWB selectable by OSD
Power source	DC12V / AC24V
Operating current	210mA / DC12V(IR Off), 630mA / DC12V(IR On)
	110mA / AC24V(IR Off), 250mA / AC24V(IR On)
LENS	2.8-12mm Varifocal motorized lens(F1.4)
IR spectrum	850nm
Viewable distance	Up to 150ft at moonless night
Iris control	DC
MTBF of IR	20,000 hours
Operation Temperature	-10°C to +50°C
Humidity	0% to 90% RH
Measurement(mm)	110(W) x 138(H) x 272.3(D)
Weight(Approx. g)	2,500
Function	
WDR	Low / Normal / Middle / High
AGC	Low / Normal / High
BLC	On/Off
Fluorescent	Off / CRR / CRR2
ICR DVR Tool	Off / EDGE / MAX / FLEX / ELITE
RS485	Pelco-D
Flip	Off / Horiz / Vert / Both

* Specifications are subject to change without prior notice for improvement.

MEMO

MEMO

MEMO

MEMO

MEMO

MEMO
