



# 32 x 32 Modular Matrix Switch

## VM3200 User Manual



[www.aten.com](http://www.aten.com)

## EMC Information

---

### FEDERAL COMMUNICATIONS COMMISSION INTERFERENCE STATEMENT

This equipment has been tested and found to comply with the limits for a Class A digital device, pursuant to Part 15 of the FCC Rules. These limits are designed to provide reasonable protection against harmful interference when the equipment is operated in a commercial environment. This equipment generates, uses, and can radiate radio frequency energy and, if not installed and used in accordance with the instruction manual, may cause harmful interference to radio communications. Operation of this equipment in a residential area is likely to cause harmful interference in which case the user will be required to correct the interference at his own expense.

The device complies with Part 15 of the FCC Rules. Operation is subject to the following two conditions: (1) this device may not cause harmful interference, and (2) this device must accept any interference received, including interference that may cause undesired operation.

**FCC Caution:** Any changes or modifications not expressly approved by the party responsible for compliance could void the user's authority to operate this equipment.

**Warning:** Operation of this equipment in a residential environment could cause radio interference.

**Suggestion:** Shielded twisted pair (STP) cables must be used with the unit to ensure compliance with FCC & CE standards.

**KC Information:** 이 기기는 업무용(A급)전자파 적합기기로서 판매자 또는 사용자는 이점을 주의하시기 바라며, 가정외의 지역에서 사용하는 것을 목적으로 합니다.

## RoHS

---

This product is RoHS compliant.

## SJ/T 11364-2006

The following contains information that relates to China.

部件名称	有毒有害物质或元素					
	铅	汞	镉	六价铬	多溴联苯	多溴二苯醚
电器部件	●	○	○	○	○	○
机构部件	○	○	○	○	○	○

○: 表示该有毒有害物质在该部件所有均质材料中的含量均在SJ/T 11363-2006规定的限量要求之下。

●: 表示符合欧盟的豁免条款，但该有毒有害物质至少在该部件的某一均质材料中的含量超出SJ/T 11363-2006的限量要求。

×: 表示该有毒有害物质至少在该部件的某一均质材料中的含量超出SJ/T 11363-2006的限量要求。



# Table of Contents

---

## Preface

About this Manual . . . . .	ix
Conventions . . . . .	x
Product Information . . . . .	x
User Information . . . . .	xi
Online Registration . . . . .	xi
Telephone Support . . . . .	xi
User Notice . . . . .	xi
Package Contents . . . . .	xii
VM3200 . . . . .	xii
VM7514 / VM8514 . . . . .	xii
VM7814 / VM8814 . . . . .	xii
VM7804 / VM8804 . . . . .	xiii
VM7604 / VM8604 . . . . .	xiii
VM7104 . . . . .	xiii
VM7404 . . . . .	xiii
VE805R . . . . .	xiv

## 1. Introduction

Overview . . . . .	1
Features . . . . .	4
VM3200 . . . . .	4
VM7514 / VM8514 . . . . .	5
VM7814 / VM8814 . . . . .	6
VM7804 / VM8804 . . . . .	7
VM7604 / VM8604 . . . . .	8
VM7104 . . . . .	8
VM7404 . . . . .	9
VE805R . . . . .	10
Requirements . . . . .	11
Input / Output Board . . . . .	11
Source Devices . . . . .	11
Display Devices . . . . .	11
Cables . . . . .	12
Browsers . . . . .	13
Optional Equipment . . . . .	13
Components . . . . .	14
VM3200 Front View . . . . .	14
VM3200 Rear View . . . . .	16
VM7514 Front View . . . . .	18
VM8514 Front View . . . . .	18
VM7814/VM7804 Front View . . . . .	19

---

VM8814/VM8804 Front View	19
VM7604 Front View	20
VM8604 Front View	20
VM7104 Front View	21
VM7404 Front View	21
VE805R Front View	22
VE805R Rear View	22
<b>2. Hardware Setup</b>	
Transporting and Storing the Unit	23
Rack Mounting	24
Grounding	27
Input / Output Board Installation	28
Cable Connection	30
Installation Diagram	31
<b>3. Front Panel Operation</b>	
Overview	33
Front Panel Pushbuttons	33
Basic Navigation	33
Front Panel LCD	34
LCD Password	34
Port Switching	36
Video / Audio Pushbutton	36
Profile Pushbutton	41
LCD Menu	42
LCD Main Screen	43
IP Setting	44
Serial Port Setting	45
Baud Rate	45
Operation Mode	46
EDID	46
CEC	47
OSD	48
Output Status	49
Security Mode	51
Mode	51
Change Password	52
Saving Configurations to Profile	54
Playing/Stopping the Profile Schedule	55
Turning Video Wall Off	55
<b>4. Browser Operation</b>	
Overview	57
Logging In	57
Main Page	58

---

Menu Bar	58
Profile List	59
Adding/Playing a Profile	59
Importing/Exporting a Profile	61
Profile List Options	62
Profile	62
Play Window	63
Change Input	64
Live Streaming View	65
Profile Scheduling	66
Adding Profiles	67
Editing Profile Scheduling	68
Playing Profile Scheduling	70
Connection Profiles	71
Layout Type	71
Side Panel	72
Main Page	74
Output Icon	75
Video Wall	78
Null Input	79
Independent Output	79
Grouping	80
Group	80
Display Preferences	81
Output Options	84
Audio Control	84
Video Control	85
System Settings	87
General	88
Serial Settings	88
Fan Status	89
Power Status	89
Device Info	89
Other	91
User Account	92
Add Account	93
Permission Level	94
Port Name	95
Network	96
EDID	97
EDID & CEA Description	99
Maintenance	107
Upgrading the VM3200	107
Upgrading the VE805R	108
IR/RS232 Channel	109
HDCP	111

OSD/CEC .....	112
Telnet Operation .....	113
Configuration Menu .....	113
1. H – Call up the command list for help .....	113
2. IP – Set IP address .....	114
3. LO – Load connections from profile .....	114
4. PW – Change password .....	114
5. RI – Read what input is connected to nn output .....	114
6. RO – Read what output is connected to nn input .....	114
7. SB – Set serial port baud rate .....	114
8. SS – Switch input to specified output .....	114
9. SV – Save the current connections into a profile .....	114
10. TI – Set timeout .....	115
11. VR – Software version information .....	115
<b>5. RS-232 Commands</b>	
Serial Control Protocol Commands .....	117
RS232 Pin Assignment .....	117
Configuring the Serial Port .....	117
RS-422 / RS-485 .....	118
Verification .....	118
Switch Port Command .....	119
Mute Command .....	122
Volume Command .....	124
Save/Load Profile Commands .....	126
EDID Mode Command .....	128
CEC Command .....	130
Read Command .....	131
Reset Command .....	133
Baud Rate Command .....	134
OSD Command .....	135
Echo Command .....	136
Scaling Command .....	137
Fan Speed Command .....	142
Alert Command .....	143
<b>Appendix</b>	
Safety Instructions .....	145
General .....	145
Rack Mounting .....	147
Technical Support .....	148
International .....	148
North America .....	148
Specifications .....	149
VM3200 .....	149
VM7514 / VM8514 .....	151

VM7814 / VM8814 .....	152
VM7804 / VM8804 .....	153
VM7604 / VM8604 .....	154
VM7104 .....	155
VM7404 .....	156
VE805R .....	157
VM-PWR800 .....	158
VM-FAN556 .....	158
Limited Warranty .....	159



# Preface

## About this Manual

This user manual is provided to help you get the most from your VM3200 Modular Matrix Solution Series, which includes the following the following product models:

Device Type	Model	Product Name
Modular Matrix Switch	VM3200	32 x 32 Modular Matrix Switch
Input / Output Board	VM7514 / VM8514	4-Port HDBaseT Input / Output Board
	VM7814 / VM8814	4-Port 4K HDMI Input / Output Board
	VM7804 / VM8804	4-Port HDMI Input / Output Board
	VM7604 / VM8604	4-Port DVI Input / Output Board
	VM7104	4-Port VGA Input Board
	VM7404	4-Port 3G-SDI Input Board
Video Receiver	VE805R	HDMI HDBaseT Lite Receiver with Scaler

This manual covers all aspects of installation, configuration and operation of the VM3200 Modular Matrix system. An overview of the information found in the manual is provided below.

**Chapter 1, Introduction**, introduces you to the Modular Matrix Solution system and its components. Its purpose, features and benefits are presented, and its front and back panel components are described.

**Chapter 2, Hardware Setup**, describes how to set up the hardware for your Modular Matrix Solution installation.

**Chapter 3, Front Panel Operation**, explains the fundamental concepts involved in operating the VM3200 at the local site via the front panel LCD display using pushbuttons.

**Chapter 4, Browser Operation**, provides a complete description of the Modular Matrix Solution's web Graphical User Interface (GUI), and how to use it to remotely configure and operate the Modular Matrix Solution.

**Chapter 5, RS-232 Commands**, provides a complete list of the serial control protocol commands used when utilizing the RS-232 Serial Port so that an extra source device can be utilized in the installation.

**An Appendix**, provides specifications and other technical information regarding the Modular Matrix Solution.

---

**Note:**

- ◆ Read this manual thoroughly and follow the installation and operation procedures carefully to prevent any damage to the device or to any other connected devices.
  - ◆ The VM3200 product firmware may have been updated with new features after the release of this manual. For an up-to-date VM3200 user manual, visit <http://www.aten.com/global/en/>
- 

## Conventions

---

This manual uses the following conventions:

- `Monospaced`      Indicates text that you should key in.
- [ ]      Indicates keys you should press. For example, [Enter] means to press the **Enter** key. If keys need to be chorded, they appear together in the same bracket with a plus sign between them: [Ctrl+Alt].
1.      Numbered lists represent procedures with sequential steps.
- ◆      Bullet lists provide information, but do not involve sequential steps.
- Indicates selecting the option (on a menu or dialog box, for example), that comes next. For example, Start → Run means to open the *Start* menu, and then select *Run*.
-       Indicates critical information.

## Product Information

---

For information about all ATEN products and how they can help you connect without limits, visit ATEN on the Web or contact an ATEN Authorized Reseller. Visit ATEN on the Web for a list of locations and telephone numbers:

---

International	<a href="http://www.aten.com">http://www.aten.com</a>
---------------	---

---

---

## User Information

---

### Online Registration

Be sure to register your product at our online support center:

International	<a href="http://eservice.aten.com">http://eservice.aten.com</a>
---------------	---

### Telephone Support

For telephone support, call this number:

International	886-2-8692-6959
China	86-400-810-0-810
Japan	81-3-5615-5811
Korea	82-2-467-6789
North America	1-888-999-ATEN ext 4988
United Kingdom	44-8-4481-58923

### User Notice

All information, documentation, and specifications contained in this manual are subject to change without prior notification by the manufacturer. The manufacturer makes no representations or warranties, either expressed or implied, with respect to the contents hereof and specifically disclaims any warranties as to merchantability or fitness for any particular purpose. Any of the manufacturer's software described in this manual is sold or licensed *as is*. Should the programs prove defective following their purchase, the buyer (and not the manufacturer, its distributor, or its dealer), assumes the entire cost of all necessary servicing, repair and any incidental or consequential damages resulting from any defect in the software.

The manufacturer of this system is not responsible for any radio and/or TV interference caused by unauthorized modifications to this device. It is the responsibility of the user to correct such interference.

The manufacturer is not responsible for any damage incurred in the operation of this system if the correct operational voltage setting was not selected prior to operation. PLEASE VERIFY THAT THE VOLTAGE SETTING IS CORRECT BEFORE USE.

**Caution:** There is a risk of explosion if the battery is replaced by an incorrect type. Always dispose of used batteries according to the relevant instructions.

## **Package Contents**

---

Check to make sure that all of the components are present and in good order. If anything is missing or was damaged in shipping, contact your dealer.

### **VM3200**

The VM3200 package consists of:

- ◆ 1 VM3200 Modular Matrix Switch
- ◆ 1 Power Cord
- ◆ 1 Terminal Block
- ◆ 1 User Instructions\*

### **VM7514 / VM8514**

The 4-Port HDBaseT Input / Output Board package consists of:

- ◆ 1 VM7514 4-Port HDBaseT Input Board
- ◆ 1 VM8514 4-Port HDBaseT Output Board
- ◆ 4 Terminal Blocks
- ◆ 1 IR Transmitter
- ◆ 1 IR Receiver
- ◆ 1 User Instructions\*

### **VM7814 / VM8814**

The 4-Port 4K HDMI Input / Output Board package consists of:

- ◆ 1 VM7814 4-Port 4K HDMI Input Board
- ◆ 1 VM8814 4-Port 4K HDMI Output Board
- ◆ 4 Terminal Blocks
- ◆ 4 HDMI LockPro
- ◆ 1 User Instructions\*

**VM7804 / VM8804**

The 4-Port HDMI Input / Output Board package consists of:

- ◆ 1 VM7804 4-Port HDMI Input Board
- ◆ 1 VM8804 4-Port HDMI Output Board
- ◆ 4 Terminal Block
- ◆ 1 User Instructions\*

**VM7604 / VM8604**

The 4-Port DVI Input / Output Board package consists of:

- ◆ 1 VM7604 4-Port DVI Input Board
- ◆ 1 VM8604 4-Port DVI Output Board
- ◆ 4 Terminal Block
- ◆ 1 User Instructions\*

**VM7104**

The 4-Port VGA Input Board package consists of:

- ◆ 1 VM7104 4-Port VGA Input Board
- ◆ 4 Terminal Block
- ◆ 1 User Instructions\*

**VM7404**

The 4-Port 3G-SDI Input Board package consists of:

- ◆ 1 VM7404 4-Port 3G-SDI Input Board
- ◆ 4 Terminal Block
- ◆ 1 User Instructions\*

## **VE805R**

The HDMI HDBaseT Lite Receiver with Scaler package consists of:

- ◆ 1 VE805R HDMI HDBaseT Lite Receiver with Scaler
- ◆ 1 Power Adapter
- ◆ 1 Terminal Block
- ◆ 1 IR Transmitter
- ◆ 1 IR Receiver
- ◆ 1 User Instructions\*

# Chapter 1

## Introduction

### Overview

---

This ATEN Modular Matrix Solution Series is comprised of the VM3200 Modular Matrix Switch, input boards, output boards, and VE805R HDMI HDBaseT Lite Receiver with Scaler.

The VM3200 Modular Matrix Switch offers advanced access and real-time control of multiple local and remote A/V input devices and displays from a single chassis. Operators can work from 4 x 4 up to 32 x 32 inputs and outputs simultaneously, as well as incorporate multiple digital video formats within the setup. It uses TMDS technology to support high speed data transfer at 1080p / 1920 x 1200 @ 60Hz / 4K x 2K @ 30Hz (4:4:4).

The VM7514 / VM8514 4-Port HDBaseT Input/Output Boards offers an easy way to route any of 4 HDBaseT audio/video sources to any of 4 HDBaseT display devices, in combination with the ATEN Modular Matrix Switch. When the VM8514 HDBaseT Output Board is used in conjunction with the VE805R HDBaseT Extender it features Seamless Switch technology and video wall functionality.

The VM7814 / VM8814 is a 4-Port 4K HDMI input/output board that works with VM3200 to route 4 HDMI sources to 4 displays. The VM7814 / VM8814 is equipped with 4 input/output ports to allow for stereo audio embedding and audio extraction. The VM8814 supports Seamless Switch™ to ensure real-time video switching, a built-in 4K scaler to handle videos of different resolutions, and EDID Expert™ to ensure high video quality.

The VM7804 / VM8804 4-Port HDMI Input / Output Board is a hot-swappable I/O board that offers an easy way to route any of 4 audio/video sources to any of 4 displays and installs in the Modular Matrix Switch. The VM8804 supports Seamless Switch technology that provides video switching in real-time, a built in scaler that handles different video resolutions, and EDID Expert technology for fast smooth switching between displays. The VM7804 / VM8804 also supports separate stereo audio signals that can be routed independently and extracted from embedded HDMI audio signals.

The VM7604 / VM8604 4-Port DVI Input / Output Board is a hot-swappable I/O board that offers an easy way to route any of 4 audio/video sources to any of 4 displays and installs in the Modular Matrix Switch. The VM8604 supports Seamless Switch technology that provides video switching in real-time, a built in scaler that handles different video resolutions and EDID Expert technology for fast smooth switching between displays.

The VM7104 4-Port VGA Input Board offers an easy way to route 4 VGA video and audio sources to 4 displays and speakers. In addition, the VM7104 can be mixed with any modular output boards on the VM3200 for optimum flexibility.

The VM7404 is a 4-Port 3G-SDI input board provides the capability to connect to SDI sources, such as 3G-SDI, HD-SDI and SD-SDI, and supports high quality video resolutions up to 1080p @ 60Hz. The VM7404 also supports separate analog stereo audio signals for independent routing.

The VE805R HDMI HDBaseT Lite Receiver with Scaler can be combined with an ATEN HDMI HDBaseT transmitter or splitter to extend your HDMI display up to 70 m from the source using a single Cat 6a cable (or up to 60 m when using a single Cat 5e cable). With a built-in scaler, the VE805R supports the scaling of different video resolutions. When combined with ATEN HDBaseT output boards, it supports video wall functionality. In addition, the VE805R is equipped with RS232 and IR signaling pass-through which allows RS232 and IR channel control from the remote to local unit, to control the HDMI source, or from the local to remote unit, to control the display device. The VE805R is HDCP compliant.

Combining these devices, this solution can be conveniently customized, allowing users to independently switch and route video and/or audio signals to various monitors, displays, projectors, and/or speakers simply by pressing front panel pushbuttons. The VM3200's built-in Scaler encodes video formats in order to provide seamless, real-time switching while ensuring stable signal transmission. In addition, the front panel LCD shows a quick view of active port connections, and includes an option to select an EDID Mode that yields the best resolution across different monitors.

The VM3200 is easily expandable and accommodates ATEN's hot-swappable I/O boards. Equipped with automatic signal conversion, it allows a combination of digital video formats, thus making it ideal for large-scale A/V applications.



Setup is fast and easy; install the modular I/O boards by sliding them into the VM3200's rear panel slots, then plug the device cables into the appropriate ports on the I/O boards and you're ready.

This solution can be connected to the network through the VM3200's LAN port, allowing the installation to take advantage of internal Cat 5 Ethernet wiring built into most modern commercial buildings. Once initial network setup has been accomplished at the local level, the VM3200 can be conveniently managed remotely using any web browser. Furthermore, for complete systems integration, the VM3200's built-in RS-232 and RS-485/RS-422 ports allow the switch to be configured through a high-end controller or PC.

The ATEN Modular Matrix Solution Series is a powerful integrated A/V setup targeted towards broadcasting stations, traffic and transportation-related control rooms, emergency service centers and any application that requires customizable high speed A/V signal routing.

## Features

---

### **VM3200**

- ◆ Connects any of 32 video sources to any of 32 displays in combination with ATEN Modular Matrix Solutions
- ◆ Built-in Scaler on each output port converts input resolutions into the display's native resolution
- ◆ Supports 4K resolutions up to UHD (3840 x 2160) and DCI (4096 x 2160) with refresh rates of 30 Hz (4:4:4) and 60 Hz (4:2:0)
- ◆ Seamless Switch™ – ATEN FPGA design unifies video formats to provide continuous video streams, real-time switching, and stable signal transmissions\*
- ◆ Video Wall – allows you to create custom video wall layouts via intuitive web GUI
- ◆ Live stream of connected video channels and image preview of video wall layouts via web GUI
- ◆ Calendar-based scheduling plays connection profiles synchronized with real-time clock
- ◆ EDID Expert™ – selects optimum EDID settings for smooth power-up and highest quality display
- ◆ Multiple Control Methods – system management via front-panel pushbuttons, RS-232, RS-485/422, and Ethernet (Telnet / Web GUI) connections
- ◆ Hot-pluggable fan and power modules for easy maintenance and higher reliability
- ◆ Flexible system expandability via hot-swappable tool-free installation of I/O boards
- ◆ Optional redundant power supply that ensures reliability for mission-critical applications
- ◆ Audio-enabled, HDMI audio can be extracted, and stereo audio can be embedded (VM7804/VM8804, VM7814/VM8814 only)
- ◆ HDMI (3D, Deep Color) (VM7804/VM8804, VM7814/VM8814 only); HDCP 1.4 compatible (VM7804/VM8804 only), HDCP 2.2 compatible (VM7814/VM8814 only)
- ◆ Consumer Electronics Control (CEC) support (VM7804/VM8804, VM7814/VM8814 only)

- ◆ ESD protection for HDMI
- ◆ Firmware upgradeable
- ◆ Aluminum frame provides light-weight design
- ◆ Rack mountable.

---

**Note:** Video outputs will not display 3D, Deep Color, or interlace (i.e., 1080i) resolutions correctly if Seamless Switch™ is enabled. To use these features, make sure to first disable Seamless Switch™.

---

### **VM7514 / VM8514**

- ◆ Compatible with the VM3200 and can be mixed with modular I/O boards of any type for optimum flexibility
- ◆ Bi-directional RS-232 serial port for control and configuration
- ◆ HDBaseT Connectivity – extends 4 HDBaseT connections up to 100 meters via single Cat 5e/6 cable
- ◆ HDBaseT Anti-jamming – resists signal interference during video transmission using
- ◆ HDBaseT technology
- ◆ Connected to VE805R:
  - ◆ Seamless Switch™ – features close-to-zero-second switching to provide continuous video streams, real-time switching, and stable signal transmissions
  - ◆ Video Wall – features configurable video wall profiles for custom layouts via point-n-click web GUI
- ◆ Bi-directional IR channel for IR signal control; IR transmission is processed one way at a time
- ◆ Supports full frequency IR signal from 30KHz to 60KHz

## **VM7814 / VM8814**

- ◆ Compatible with the VM1600/VM3200 and can be mixed with modular I/O boards of any type for optimum flexibility
- ◆ Superior video quality – HDTV resolutions of 480p, 720p, 1080i, and 1080p (1920 x 1080); VGA, SVGA, SXGA, UXGA, WUXGA (1920 x 1200), and 4K2K @ 60Hz (4:2:0)
- ◆ Audio-enabled, HDMI audio can be extracted and stereo audio can be embedded
- ◆ Scaler – features a 4K video scaling function to convert input resolutions to the optimum resolutions for display\* (VM8814 only)
- ◆ Seamless Switch™ – features close-to-zero-second switching to provide continuous video streams, real-time switching, and stable signal transmissions\* (VM8814 only)
- ◆ Video Wall – features configurable video wall profiles for custom layouts via point-n-click web GUI\* (VM8814 only)
- ◆ EDID Expert™ – selects optimum EDID settings for smooth power-up and highest quality display
- ◆ HDMI (3D, Deep Color)\*; HDCP 2.2 Compatible
- ◆ HDMI (cables) signal detection
- ◆ Consumer Electronics Control (CEC) support

---

### **Note:**

When Seamless Switch™ is enabled, mind the following:

- ◆ Video outputs will not display 3D, Deep Color, or interlace (i.e., 1080i) resolutions correctly. To use these features, make sure to first disable Seamless Switch™.
  - ◆ Videos may not display within range, in which case make sure to adjust the display settings on your device.
-

**VM7804 / VM8804**

- ◆ 4 HDMI input ports (VM7804); 4 HDMI output ports (VM8804 only)
- ◆ Superior video quality – HDTV resolutions of 480p, 720p and 1080p (1920 x 1080); VGA, SVGA, XGA, SXGA and WUXGA (1920 x 1200)
- ◆ HDMI (3D, Deep Color)\*; HDCP 1.4 Compatible
- ◆ Consumer Electronics Control (CEC) support
- ◆ Audio-enabled, HDMI audio can be extracted and stereo audio can be embedded
- ◆ Scaler – features a 4K video scaling function to convert input resolutions to the optimum resolutions for display\* (VM8804 only)
- ◆ Seamless Switch™ – features close-to-zero-second switching to provide continuous video streams, real-time switching, and stable signal transmissions\* (VM8804 only)
- ◆ Video Wall – features configurable video wall profiles for custom layouts via point-n-click web GUI\* (VM8804 only)
- ◆ Hot-swappable design

---

**Note:**

When Seamless Switch™ is enabled, mind the following:

- ◆ Video outputs will not display 3D, Deep Color, or interlace (i.e., 1080i) resolutions correctly. To use these features, make sure to first disable Seamless Switch™.
  - ◆ Videos may not display within range, in which case make sure to adjust the display settings on your device.
-

## **VM7604 / VM8604**

- ◆ 4 DVI-D input ports (VM7604 only); 4 DVI-D output ports (VM8604 only)
- ◆ Superior video quality – HDTV resolutions of 480p, 720p and 1080p (1920 x 1080); VGA, SVGA, XGA, SXGA and WUXGA (1920 x 1200)
- ◆ Scaler – features a 4K video scaling function to convert input resolutions to the optimum resolutions for display\* (VM8604 only)
- ◆ Seamless Switch™ – features close-to-zero-second switching to provide continuous video streams, real-time switching, and stable signal transmissions\* (VM8604 only)
- ◆ Video Wall – features configurable video wall profiles for custom layouts via point-n-click web GUI\* (VM8604 only)
- ◆ HDCP 1.4 Compatible
- ◆ EDID Expert™ – selects optimum EDID settings for smooth power-up and highest quality display
- ◆ Hot-swappable design
- ◆ Audio-enabled

---

### **Note:**

When Seamless Switch™ is enabled, mind the following:

- ◆ Video outputs will not display 3D, Deep Color, or interlace (i.e., 1080i) resolutions correctly. To use these features, make sure to first disable Seamless Switch™.
- ◆ Videos may not display within range, in which case make sure to adjust the display settings on your device.

---

## **VM7104**

- ◆ Connects 4 VGA inputs
- ◆ Superior video quality – up to 1920 x 1200 @ 60Hz
- ◆ Supports RGBHV / RGBS / YCbCr / YPbPr input signals
- ◆ Hot-swappable design

---

**Note:** When the VM7104 is used with the VM8514+VE805R, VM8804 or VM8604, the Seamless Switch, scaler, and video wall functions can be activated.

---

**VM7404**

- ◆ Four 3G-SDI inputs - allows you to easily switch between four media sources (such as professional cameras) with automatic detection of signal type (e.g. 3G-SDI, HD-SDI and SD-SDI)
- ◆ Analog stereo inputs - The four analog balanced/unbalanced stereo audio inputs separate audio routing within the system.
  - ◆ The analog stereo audio input can be integrated into HDMI TMDS signals (the TMDS audio signals will be replaced), and the SDI audio signals can be extracted and sent to the stereo audio output ports
- ◆ Supported SDI formats:
  - ◆ SD-SDI (SMPTE 259M, up to 270Mbps)
  - ◆ HD-SDI (SMPTE 292M, 296M, up to 1.485Gbps)
  - ◆ 3G-SDI (SMPTE 424M, 425M level A/B-DL, up to 2.97Gbps)
- ◆ Extensive input cable equalization distance:
  - ◆ 3G-SDI in 100m
  - ◆ HD-SDI in 150m
  - ◆ SD-SDI in 300m
- ◆ Supports high-resolution video
  - ◆ SD Format Support
    - ◆ PAL/50 PAL and NTSC/59.94
  - ◆ HD Format Support
    - ◆ 1080p: 23.98, 24, 25, 29.97, 30, 50, 59.94, 60
    - ◆ 1080PsF: 25, 29.97, 30
    - ◆ 1080i: 50, 59.94, 60
    - ◆ 720p: 25, 29.97, 30, 50, 59.94, 60
- ◆ Embedded HDMI stereo audio – can be switched and embedded
- ◆ Supports Seamless Switching™
- ◆ Supports output port scaling – built-in Scaler on each output port enables scaling to different video resolutions
- ◆ Adjustable Stereo audio output volume – analog audio levels of the selected output can be adjusted and muted
- ◆ ATEN EDID Expert support – allows management of EDID data to ensure all connected sources can output content to displays reliably

## **VE805R**

- ◆ HDBaseT Connectivity – extends the connection between the VM8514 HDBaseT outputs and an HDMI display over a long distance via single Cat 5e/6 cable
- ◆ HDBaseT Anti-jamming – resists signal interference during high quality video transmissions using HDBaseT technology
- ◆ Bi-directional RS-232 serial port for control and configuration\*
- ◆ Scaler – features a scaling function to integrate a video wall seamlessly with various output formats\*
- ◆ Seamless Switch™ – close-to-zero second switching to provide continuous video streams, real-time switching, and stable signal transmissions\*
- ◆ Video Wall – features configurable video wall profiles available for custom screen layouts via simple point-n-click web GUI\*
- ◆ Supports full frequency IR signals from 30KHz to 60KHz\*
- ◆ Rack-mountable

---

### **Note:**

- ◆ The VE805R only supports Seamless Switch™ when it is used with the VM8514, VM3404H, and VM3909H.
  - ◆ When Seamless Switch™ is enabled, video outputs will not display 3D, Deep Color, or interlace (i.e., 1080i) resolutions correctly. To use these features, make sure to first disable Seamless Switch™.
  - ◆ The VE805R only supports bi-directional RS-232 transmission when it works with VM8514.
-



## Requirements

---

The following are required for a complete VM3200 Modular Matrix Solution Series installation:

### **Input / Output Board**

- ◆ VM7514 (HDBaseT input board) and VM8514 (HDBaseT output board)
- ◆ VM7814 (4K HDMI input board) and VM8814 (4K HDMI output board)
- ◆ VM7804 (HDMI input board) and VM8804 (HDMI output board)
- ◆ VM7604 (DVI input board) and VM8604 (DVI output board)
- ◆ VM7104 (VGA input board)
- ◆ VM7404 (3G-SDI input board)

### **Source Devices**

- ◆ For VM7514 4-port HDBaseT input board + VE802T HDBaseT Transmitter: Digital A/V source device with HDMI output connector(s)
- ◆ For VM7814 4-port 4K HDMI input board: Digital A/V source device with HDMI output connector(s)
- ◆ For VM7804 4-port HDMI input board: Digital A/V source device with HDMI output connector(s)
- ◆ For VM7604 4-Port DVI input board: Digital A/V source device with DVI output connector(s)
- ◆ For VM7104 4-Port VGA input board: A/V source device with VGA output connector(s)
- ◆ For VM7404 4-Port 3G-SDI Input Board: SDI sources, including 3G-SDI, HD-SDI and SD-SDI

### **Display Devices**

- ◆ For VM8514 4-port HDBaseT output board + VE805R HDBaseT Receiver: Digital Display device(s) with HDMI input connector(s)
- ◆ For VM8814 4-port 4K HDMI output board: Digital Display device(s) with HDMI input connector(s)
- ◆ For VM8804 4-port HDMI output board: Digital Display device(s) with HDMI input connector(s)
- ◆ For VM8604 4-Port DVI output board: Digital Display device(s) with DVI input connector(s)

## **Cables**

- ◆ 1 SDI cable for each source device (VM7404)
- ◆ 1 Cat 5e cable for each transmitter (VM7514)
- ◆ 1 Cat 5e cable for each receiver (VM8514)
- ◆ 1 HDMI cable for each source device (VM7814/VM7804)
- ◆ 1 HDMI cable for each display device (VM8814/VM8804)
- ◆ 1 DVI cable for each source device (VM7604)
- ◆ 1 DVI cable for each display device (VM8604)
- ◆ 1 VGA cable for each source device (VM7104)
- ◆ 1 HDMI cable for each display device (VE805R)
- ◆ 1 audio cable for each audio source device (VM7814/VM7804 / VM7604)
- ◆ 1 audio cable for each audio device / speaker (VM8814/VM8804 / VM8604)
- ◆ 1 Ethernet cable (VM3200)
- ◆ 1 RS-232 serial cable (VM3200 / VM7514 / VM8514 / VE805R)
- ◆ 1 RS-485/RS-422 serial cable (VM3200)
- ◆ 1 IR cable for each IR transmitter device (VM7514 or VM8514)
- ◆ 1 IR cable for each IR receiver device (VM7514 or VM8514)

---

**Note:** No cables are included in this package. We strongly recommend that you purchase high-quality cables of appropriate length since this will affect the quality of the audio and video display. Contact your dealer to purchase the correct cable sets.

---

## Browsers

In order to achieve the best performance, the browsers listed in the table below are recommended to be used with the VM3200's GUI.

OS	Java Version	Browser	Version
Windows 10 (64 bit)	V1.8.0_121 (64 bit)	Chrome	56.0.2924.87 (64 bit)
		Edge	38.14393.0.0
		Firefox	51.0.1
		Opera	43.0.2442.1144
Windows 8.1	V1.8.0_121	IE	11
CentOS 7.0 (64Bit)	V1.8.0_121 x64)	Firefox	51.0.1 x64

## Optional Equipment

Depending on any optional equipment that you may have purchased, one of the following may be included in your package. Contact your ATEN dealer to purchase any of these additional accessories.

Model No.	Description	Dimensions (L x W x H)	Weight
2X-034G	Easy Installation Rack Mount Kit - Short	41 to 72 cm (depth)	-
2X-035G	Easy Installation Rack Mount Kit - Long	68 to 108 cm (depth)	-
2X-030G	Video Wall TV Mounting Brackets (Left)	15.47 x 11.83 x 43.00 cm	2.00 kg
	Video Wall TV Mounting Brackets (Right)	15.47 x 12.80 x 43.00 cm	2.00 kg
2X-RC1600	Video Wall TV Stand	140.00 x 90.00 x 207.00 cm	60.00 kg
VM-PWR800	Video Matrix Power Module	-	-
VM-FAN556	Video Matrix Fan Module	-	-

# Components

## VM3200 Front View

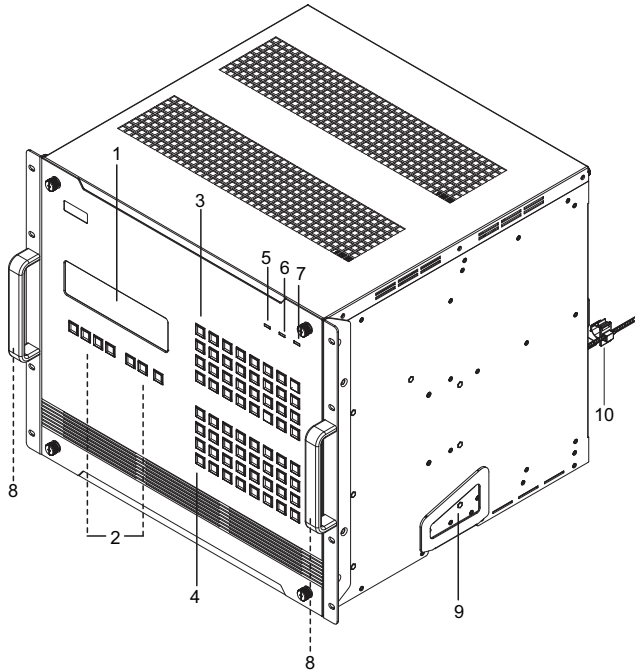

No.	Component	Description
1	LCD Display	The LCD Display shows the options for configuring and operating the VM3200. See <i>Front Panel Pushbuttons</i> , page 33, for details.
2	Function Pushbuttons	Use the UP, DOWN and CANCEL buttons to navigate the LCD display to configure the installation. Press the Video, Audio, Menu and Profile buttons to use each function. See <i>Front Panel Pushbuttons</i> , page 33, for details. <b>Note:</b> The pushbuttons have LEDs that light to indicate they have been selected.
3	Input Pushbuttons (1-32)	These pushbuttons refer to the Input ports on the VM3200 rear panel. Press to select the Input port. These pushbuttons may also correspond to menu options, profiles and other selections.
4	Output Pushbuttons (1-32)	These pushbuttons refer to the Output ports on the VM3200 rear panel. Press to select the Output port.

---

No.	Component	Description
5	Alarm LED	The Alarm LED lights red to indicate the power or fan module has failed.
6	Redundant Power LED	This LED lights green to indicate the redundant power module is plugged in and working.
7	Primary Power LED	This LED lights green to indicate the primary power module is plugged in and working.
8	Handles	The two front handles are used to install the unit into a rack.
9	Recessed Handles	The two side handles are used to transport the unit. Push in to lock and unlock the handles so that they can be used to carry the unit and be tucked away when not in use.
10	Cable Strap	A cable strap is provided to secure the power cord's plug to the VM3200.

---

## VM3200 Rear View

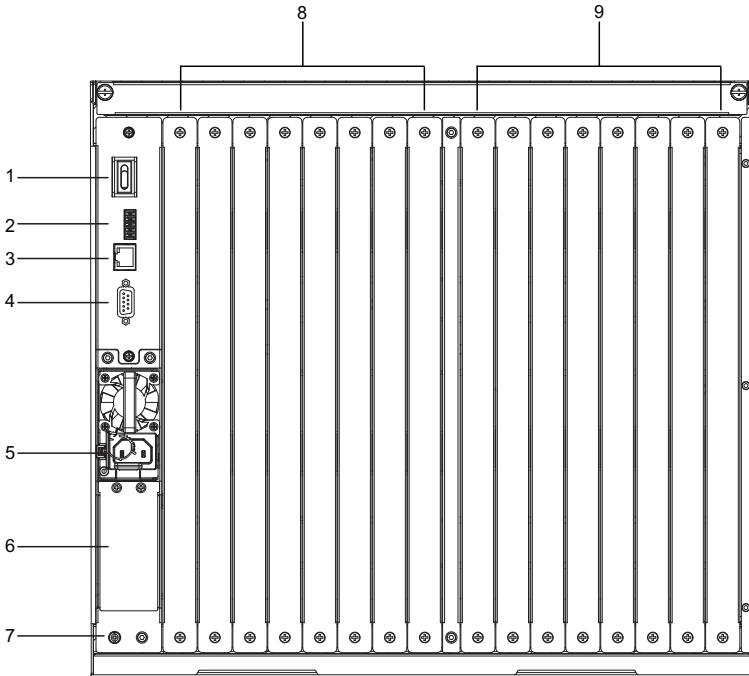

No.	Component	Description
1	Power Switch	This is a standard rocker switch that powers the unit on and off.
2	RS-485 / RS-422 Serial Port	Connect a computer or high-end system controller via this serial port.
3	Ethernet Port	In order to access the VM3200's web Graphical User Interface (GUI), the VM3200 must be connected to the network. The cable that connects the VM3200 to your LAN plugs in here. See <i>Cable Connection</i> , page 30, for further details
4	RS-232 Serial Port	Connect a computer or high-end system controller via this serial port.
5	Primary Power Supply	This is a standard 3-pin power socket. The power cord from a source plugs in here.

---

No.	Component	Description
6	Redundant Power Slot (Optional)	This slot with protective cover is used to install an additional power supply for redundant power protection. <b>Note:</b> The extra power module is not included in the VM3200 package. See , page 13, for details.
7	Grounding Terminal	The grounding wire attaches here. See <i>Grounding</i> , page 27, for further details.
8	Output Board slots	Unscrew the cover to insert the output boards into these 8 vertical slots. The display devices connect to the inserted Output boards.
9	Input Board Slots	Unscrew the cover to insert the Input boards into these 8 vertical slots. The source devices connect to the inserted Input boards.

---

## **VM7514 Front View**

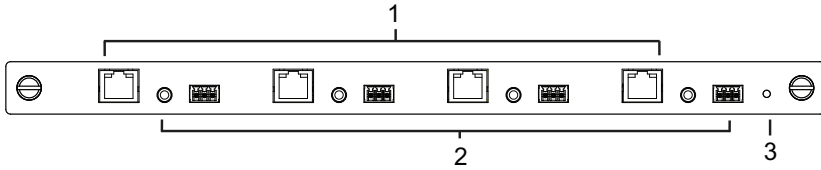

No.	Component	Description
1	HDBaseT Input Ports	Connect the Cat 5e cables from your HDBaseT transmitter to these ports.
2	IR / RS-232 Input Ports	Connect the cables from your IR transmitter to the mini stereo jack ports, and connect the cables from your RS-232 device to the RS-232 ports.
3	Status LED	Indicates the working status of the unit.

## **VM8514 Front View**

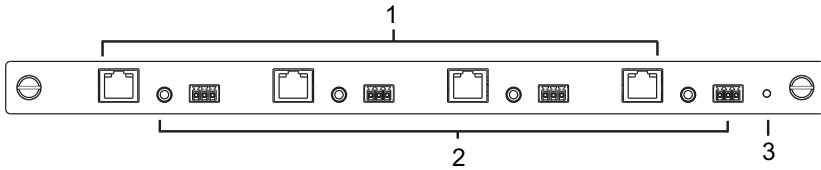

No.	Component	Description
1	HDBaseT Output Ports	Connect the Cat 5e cables from your HDBaseT receiver to these ports.
2	IR / RS-232 Output Ports	Connect the cables from your IR receiver to the mini stereo jack ports, and connect the cables from your RS-232 device to the RS-232 ports.
3	Status LED	Indicates the working status of the unit.



## VM7814/VM7804 Front View

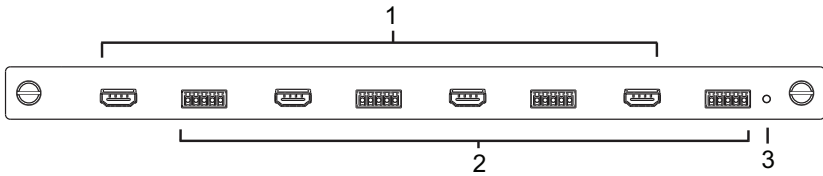

No.	Component	Description
1	HDMI Input Ports	Connect the cables from your HDMI video source devices to these ports.
2	Audio Input Ports	Connect the cables from your audio source devices to these ports.
3	Status LED	Indicates the working status of the unit.

## VM8814/VM8804 Front View

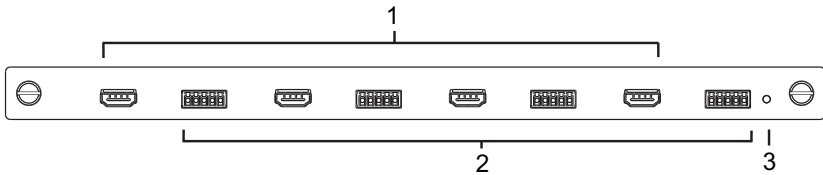

No.	Component	Description
1	HDMI Output Ports	Connect the cables from your HDMI display devices (monitors, projectors, TVs) to these ports.
2	Audio Output Ports	Connect the cables from your output audio devices or speakers to these ports.
3	Status LED	Indicates the working status of the unit.

## **VM7604 Front View**

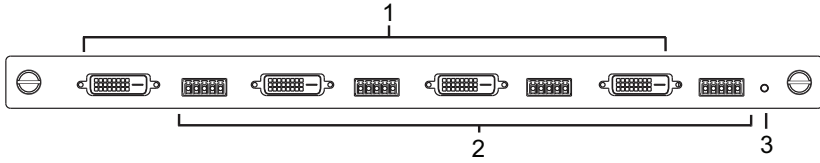

No.	Component	Description
1	DVI Input Ports	Connect the cables from your video source devices to these ports.
2	Audio Input Ports	Connect the cables from your audio source devices to these ports.
3	Status LED	Indicates the working status of the unit.

## **VM8604 Front View**

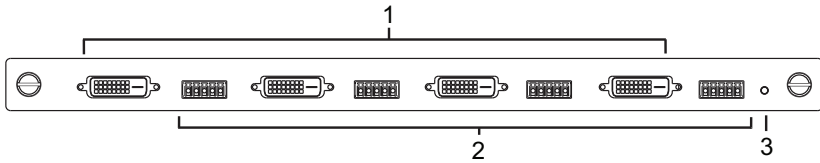

No.	Component	Description
1	DVI Output Ports	Connect the cables from display devices (monitors, projectors, TVs) to these ports.
2	Audio Output Ports	Connect the cables from your output audio devices or speakers to these ports.
3	Status LED	Indicates the working status of the unit.

## VM7104 Front View

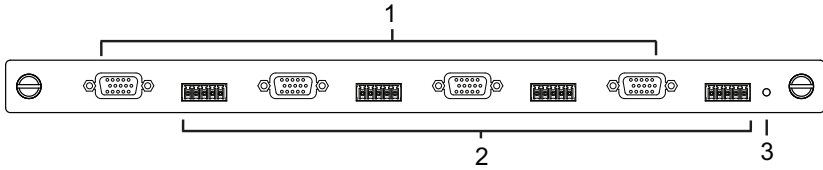

No.	Component	Description
1	VGA Input Ports	Connect the cables from your VGA video source devices to these ports.
2	Audio Input Ports	Connect the cables from your audio source devices to these ports.
3	Status LED	Indicates the working status of the unit.

## VM7404 Front View

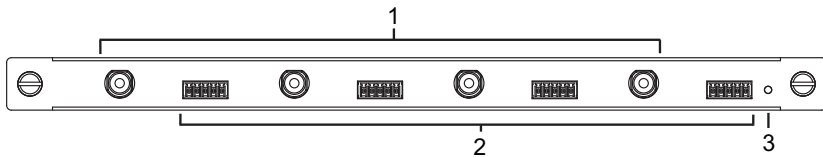

No.	Component	Description
1	SDI Input Ports	Connect the cables from your video source devices to these ports.
2	Analog Stereo Audio Input Ports	Connect the cables from your audio source devices to these ports.
3	Status LED	The VM7404 has an LED to indicate the working status.

## VE805R Front View

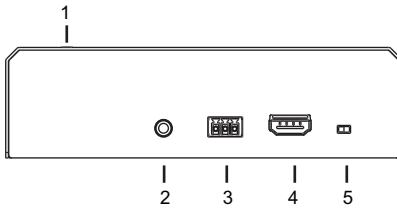

## VE805R Rear View

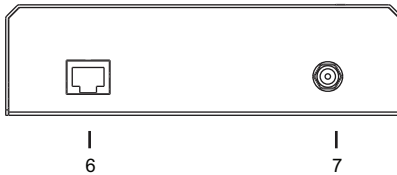

No.	Component	Description
1	LEDs	Three LEDs – Power, Link and HDMI Out – light when the unit is properly connected to an appropriate source. <ul style="list-style-type: none"> <li>◆ Power - lights Green to indicate the unit is receiving power.</li> <li>◆ Link - lights Orange to indicate that communication between VE805R and output board is established.</li> <li>◆ HDMI Out - lights Orange to indicate the HDMI output signal is good. LED blinks Orange every second to indicate that the device is in F/W upgrade mode.</li> </ul>
2	IRPort	Connect the IR transmitter or receiver cable port into this mini stereo jack port.
3	RS-232 Port	Use the captive screw connectors (3 pole) to connect the cable from your serial device into the RS-232 port.
4	HDMI Output Port	Connect the cable from your HDMI display device (monitors, projectors, TVs) into this port.
5	Firmware Upgrade Switch	Set this switch to OFF (left) for normal operation. Set this switch to ON (right) and reset the unit's power to enter the firmware upgrade mode. For details, see <i>Maintenance</i> , page 107.
6	HDBaseT Input	Use a Cat 5e cable to connect the VE805R to the VM8514 output board.
7	Power Jack	The power adapter cable plugs connects here.

# Chapter 2

## Hardware Setup



1. Important safety information regarding the placement of this device is provided on page 145. Please review it before proceeding.
2. Make sure that the power to all devices connected to the installation are turned off. You must unplug the power cords of any computers that have the Keyboard Power On function.

### Transporting and Storing the Unit

---

Its important to properly transport and store the VM3200. Follow the instructions below to avoid damaging the VM3200 due to improper handling.

When not rack mounted, the VM3200 should be placed on a flat and level surface with the bottom side down. The unit should never be placed with the front, rear or sides facing the ground.

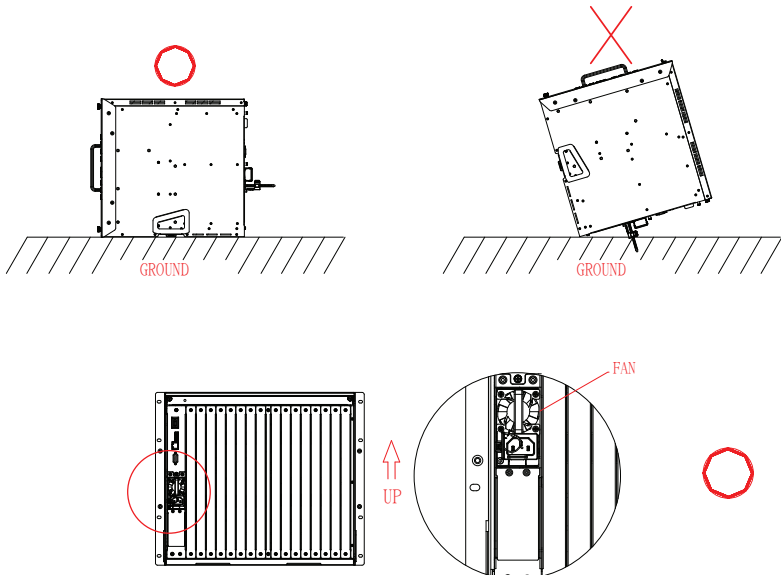

## Rack Mounting

---

The Modular Matrix Switch can be mounted in a 19" (1U) system rack. For the most convenient front panel operation at the local site, mount the unit at the front of the rack, as follows:

1. Position the unit in the front of the rack, and align the holes of the unit's built-in mounting brackets with the holes in the rack.
2. Use screws to attach the unit to the rack.

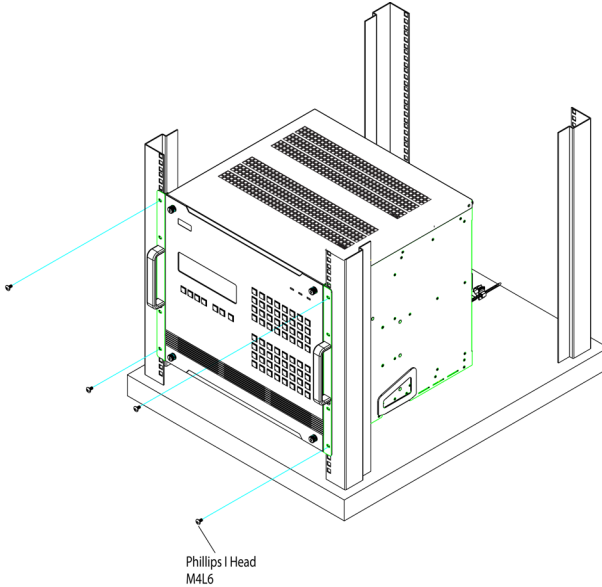

- 
- Note:**
1. Please allow 1U (44 mm) of space between the top of the VM3200 and any object to prevent obstruct of the air flow.
  2. To ensure the VM3200 has sufficient air flow, do not stack items on top or in front of the unit. Proper air flow ensures safe operation and prevents the unit from overheating.
-

## Mounting with Brackets

You can also use mounting brackets to install the VM3200, as shown below.

**Note:** The Easy Installation Mounting Kit is not included with the package (see page 13). To purchase a mounting kit please contact your dealer.

1. Screw the mounting brackets to the rack, as shown in the diagram.

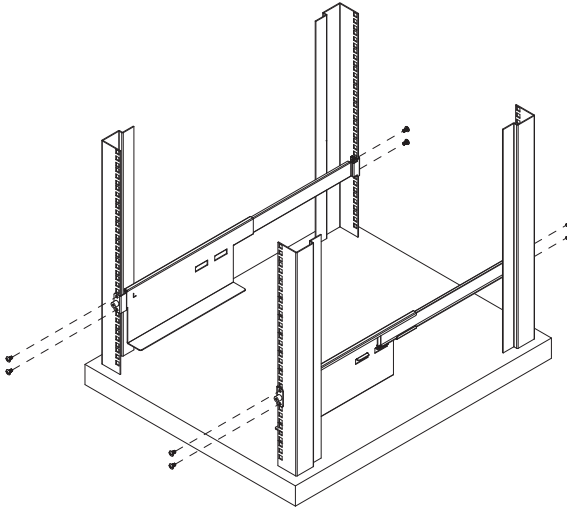

2. Push in and lock the Recessed Handles, and then slide the unit along the brackets.

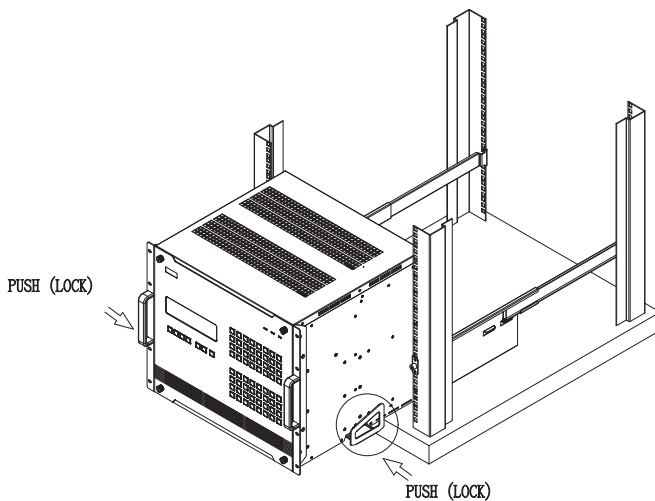

3. Screw the front panel to the rack.

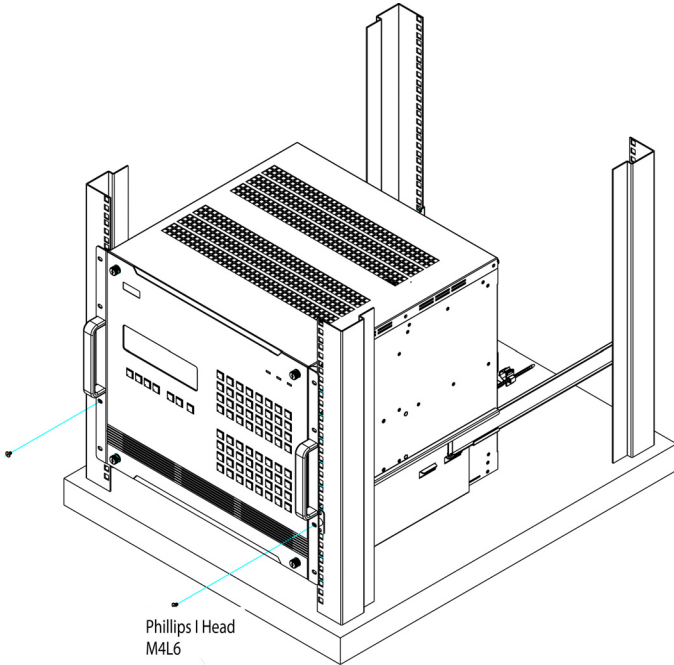

---

**Note:** 1. Please allow 1U (44 mm) of space between the top of the VM3200 and any object to prevent obstruct of the air flow.

2. To ensure the VM3200 has sufficient air flow, do not stack items on top or in front of the unit. Proper air flow ensures safe operation and prevents the unit from overheating.

---



---

## Grounding

---

To prevent damage to your installation, it is important that all devices are properly grounded.

1. Use a grounding wire to ground the installation using the VM3200's rear panel, by connecting one end of the wire to the grounding terminal, and the other end of the wire to a suitable grounded object.

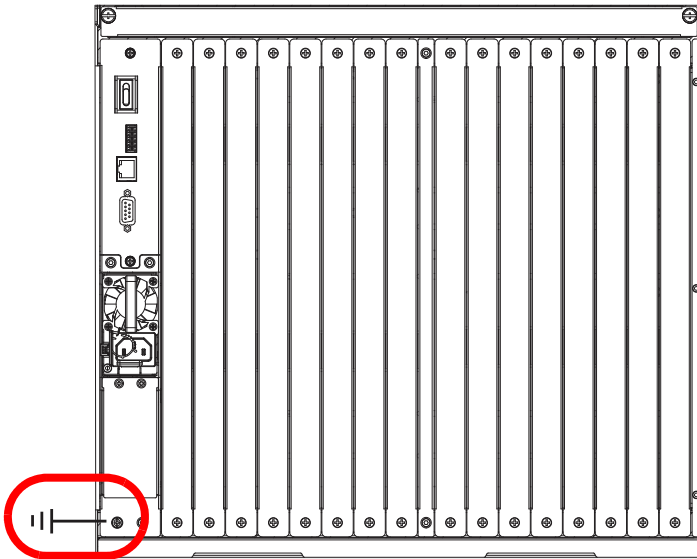

2. Make sure that all devices in your installation are properly grounded.

---

**Note:** The grounding wire is not included in the package. Please contact your dealer for details about purchasing a grounding wire.

---

## Input / Output Board Installation

---

To install the I/O boards in the VM3200, do the following:

**Note:** The eight right slots on the Modular Matrix Switch are for the Input boards. The eight left slots on the Modular Matrix Switch are for the Output boards.

---

1. On the rear of the VM3200, remove two screws from a left and right side slot, and then remove both covers.

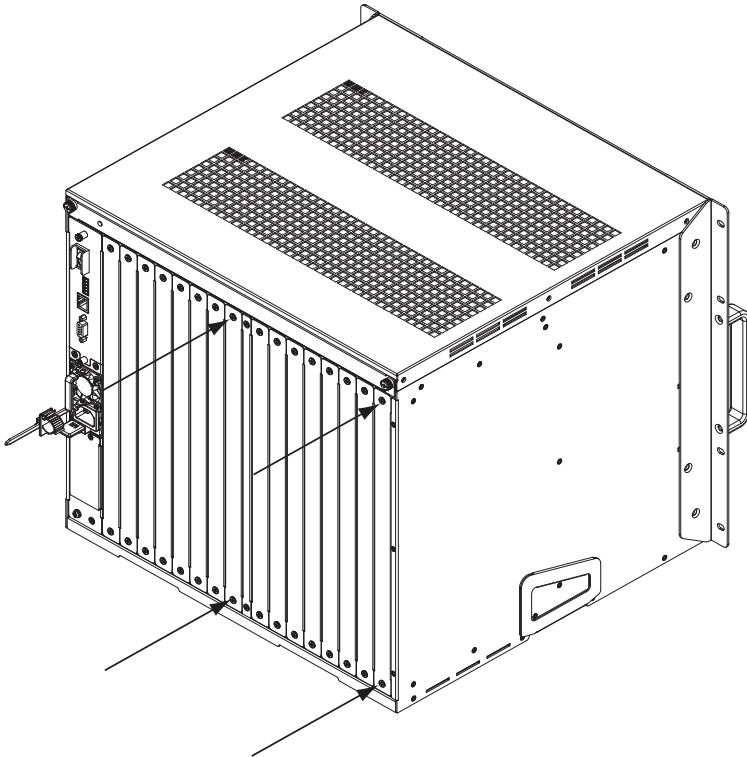

*(Continues on next page.)*

2. Slide an output board into a left side slot and then tighten the two screws to secure the board to the VM3200.

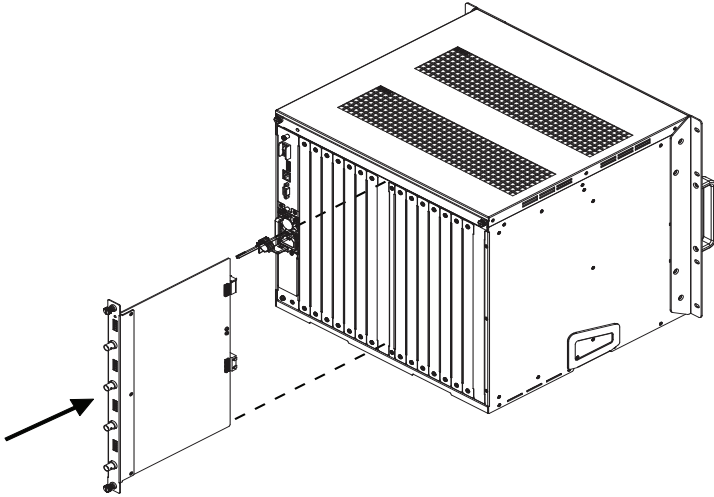

3. Slide an input board into a right side slot and then tighten the screws to secure the board to the VM3200.

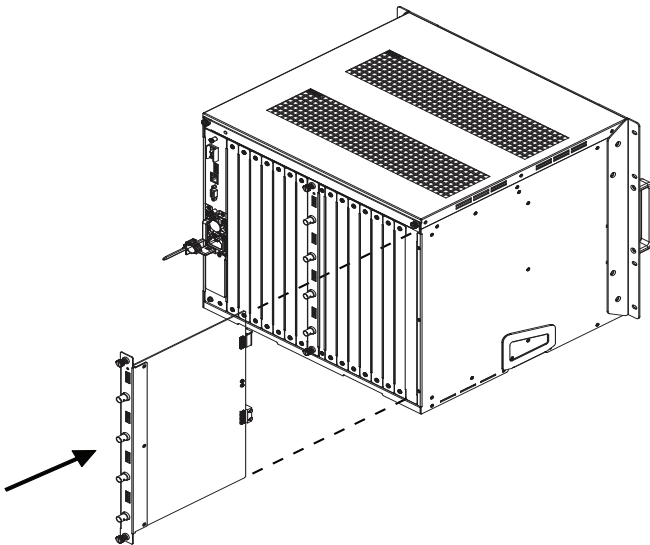

4. Repeat steps 2 and 3 to install additional I/O boards.
5. Power on the VM3200.

## Cable Connection

---

Installation of the VM3200 is simply a matter of connecting the appropriate cables. Refer to the installation diagram on the following page (the numbers in the diagram correspond to the steps below), and do the following:

1. Use a grounding wire to ground the unit by connecting one end of the wire to the grounding terminal, and the other end of the wire to a suitable grounded object.

---

**Note:** Do not omit this step. Proper grounding helps to prevent damage to the unit from surges or static electricity.

---

2. Unscrew the covers on the VM3200's rear panel and insert the I/O boards into the vertical slots (See *Input / Output Board Installation*, page 28, for details).
3. Connect your A/V source device(s) to the **Video and Audio port(s)** of the Input Board on the VM3200.
4. Connect your video display device(s) to the **Video port(s)** of the Output Board on the VM3200.
5. Connect your speakers / audio output device(s) to the **Audio port(s)** of the Output Board on the VM3200.
6. (Optional) If you are using the serial control function to control multiple VM3200's, use an appropriate serial cable to connect the computer or serial controller to the VM3200's female **RS-485 / RS-422** captive screw connector. The VM3200 package includes a terminal block that can be used for this connection.
7. (Optional) If using the remote operation features (web GUI), plug a Cat 5e cable from the network into the VM3200's **Ethernet** port.
8. (Optional) If you are using a serial control function, use an appropriate serial cable to connect the computer or serial controller to the VM3200's female **RS-232** serial port.
9. Plug the power cord supplied with the package into the VM3200's 3-prong socket, and then into a power source.
10. (Optional) Plug in an additional power module for redundancy if required.

---

**Note:** Secondary power modules are not included in the VM3200 package. For supported power module models, see *Optional Equipment*, page 13.

---

11. Power on the VM3200 and all devices in the installation.

## Installation Diagram

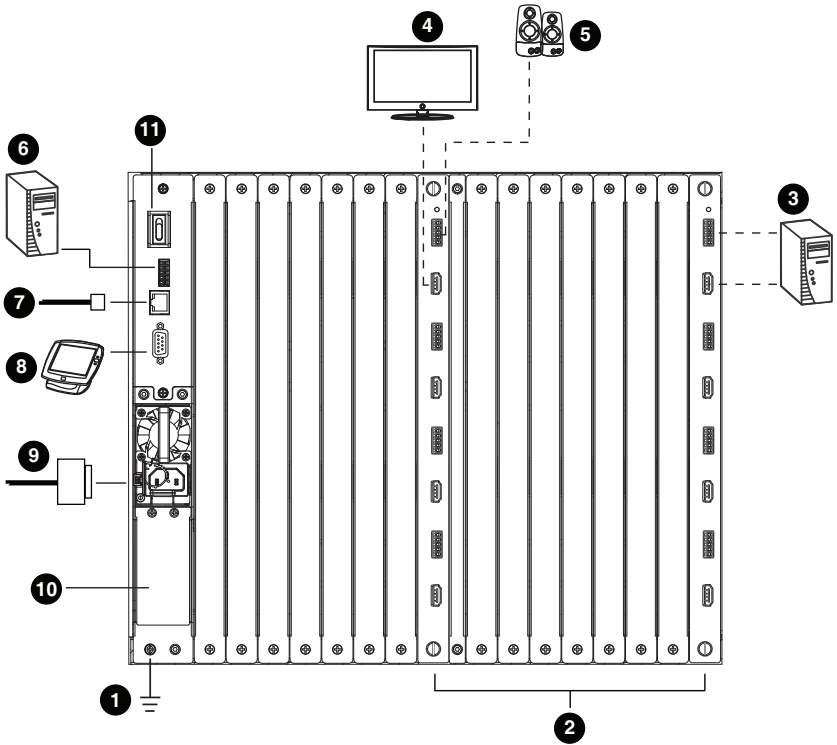

This Page Intentionally Left Blank

# Chapter 3

## Front Panel Operation

### Overview

---

The Modular Matrix Switch installation can be configured and operated locally via the VM3200 front panel LCD and pushbuttons.

### Front Panel Pushbuttons

---

The VM3200 front panel has easy-to-use pushbuttons for selecting which video/audio source shows on which display.

#### Basic Navigation

The VM3200's front panel LCD display operation is easy and convenient. Please note the following front panel button operations:

- ◆ Press the **VIDEO** pushbutton to configure the video connections.
- ◆ Press the **AUDIO** pushbutton to configure the audio connections.
- ◆ Use the **MENU** pushbutton to access the Menu page options: IP Setting, Serial Port Setting, Operation Mode, Security Mode, and Save to a Profile.
- ◆ Use the **PROFILE** pushbutton to select a profile or switch between the connection profiles which have been added to the Profile List (see page 59). Pressing this pushbutton for longer than 3 seconds displays the Save to a Profile page (see page 54).
- ◆ Use the **CANCEL** (↩) pushbutton to go back a level, return to the Main screen, stop or exit an operation.
- ◆ Use the **UP** (⬆) and **DOWN** (⬇) pushbuttons to go to the next or previous options.
- ◆ Use the Input / Output (**1–32**) pushbuttons to select the Input/Output port. The pushbuttons may also correspond to menu options, profiles, and so on.

## Front Panel LCD

The VM3200 features an LCD display for convenient configuration. This allows you to perform operations such as viewing the IP settings, configuring the serial port, setting EDID/CEC/OSD/Output Status, selecting security settings, and loading/saving connection profiles.

### LCD Password

If the VM3200 has been configured to require a password for local operation (see *Security Mode*, page 51), the password screen appears when the VM3200 is powered on, and the cursor flashes on the first digit. Enter a 4-digit password to continue to the Main Screen.

**Note:** If you are accessing the VM3200 for the first time, the default password is 1234.

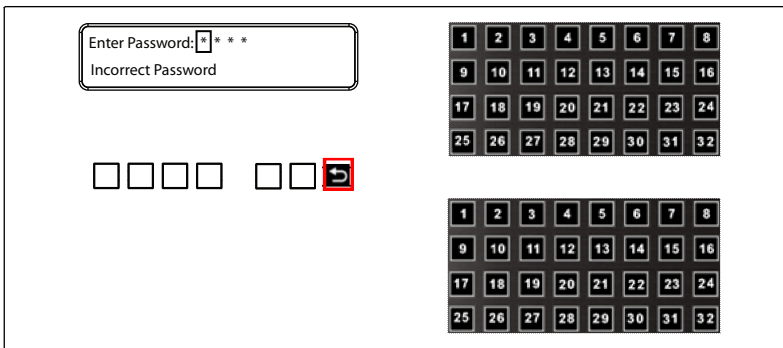

To enter a password, do the following:

1. Check that the cursor is flashing on the first digit.
2. Use the front panel number pushbuttons (1-9) to enter a 4-digit password. After the fourth digit, the cursor goes back to the first digit.



3. Press **Cancel** to clear the password. The digits revert to 4 asterisks (\*) and the cursor returns to the first digit.

---

**Note:** 1. The VM3200 password can be any four digit combination between 1111 to 9999.

2. If you enter an incorrect password, the cursor goes back to the first digit and reverts to flashing. The Incorrect Password message displays at the bottom of the screen, but clears as soon as a new digit is entered.
  3. If Password (see *Security Mode*, page 51) is Enabled, the LCD display time-out is 5 minutes by default.
-

## Port Switching

From the Main Screen, you can configure the Input-to-Output port connections to associate an Input source device to an Output display.

### Video / Audio Pushbutton

Before switching port connections, use the **Video** or **Audio** pushbuttons to select whether to switch only the video or the audio signal exclusively. Otherwise, both video and audio channels are configured together (default).

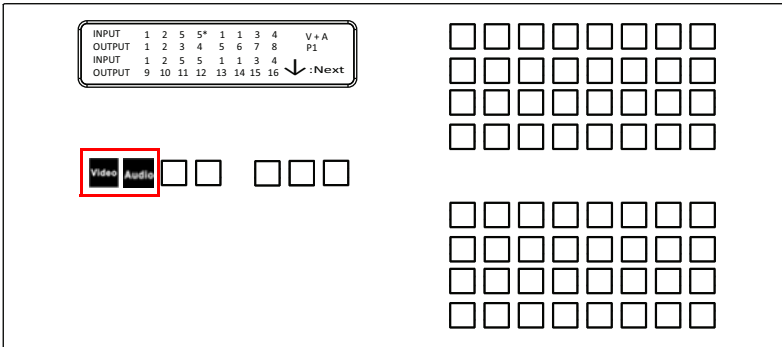

- ◆ Press the **Video\*** pushbutton to configure Video connections. The built-in LED lights up and the LCD displays **Video** on the lower right side. Press the button again to cancel.
- ◆ Press the **Audio\*** pushbutton to configure Audio connections. The built-in LED lights up and the LCD displays **Audio** on the lower right side. Press the button again to cancel.
- ◆ If both **Video** and **Audio** built-in LEDs are turned off, the video and audio channels are configured together and the LCD displays **V + A**.

---

**Note:** Press the **Video** or **Audio** pushbutton to independently switch either signal to a different source.

---

## Input Port Selection

Use the Input Port pushbuttons to select the Input port you want to configure.

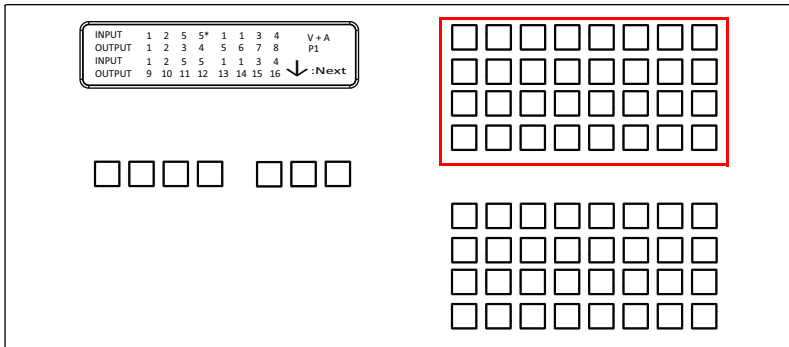

To select which input source displays on each output port, do the following:

1. Press any Input port pushbutton. The Output port LED(s) tied to the said Input port will begin to flash. Available Output port LED(s) will light up (steady).

In the example below, pressing Input port **1** shows it is tied to Output ports **1** and **2**.



2. To disconnect an Output port from an Input port, press the corresponding Output port pushbutton.

In the example below, Output port **2** has been disconnected from Input port **1**.

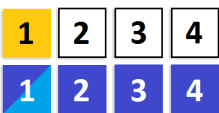

*(Continues on next page.)*

- To switch to another Input port, press any Input port pushbutton. The Output port LED(s) tied to the said Input port will flash.  
In the example below, pressing Input port **2** shows it is tied to Output ports **3** and **4**.



- To connect Output port **2** to Input port **2** in the example above, press the Output port **2** pushbutton. The Output port 2 LED will also begin to flash (0.5 sec on, 0.2 sec off). This indicates that Input port **2** is now connected to Output ports **2**, **3** and **4**.



Once the signal from the selected Input port is successfully tied to the Output port, the LEDs turn off and the LCD information is updated.

- 
- Note:**
- Pressing an Input port a second time deselects it.
  - Input ports that are not configured or tied to any output port do not appear in the LCD screen.
  - Pressing the **Cancel** pushbutton once stops the Input Port Selection operation and the LCD displays the active setting. Pressing the **Cancel** pushbutton again turns all LEDs off.
  - After 10 seconds of inactivity, all the LEDs turn off.
-

## Output Port Selection

Use the Output Port pushbuttons to select the Output port you want to configure.

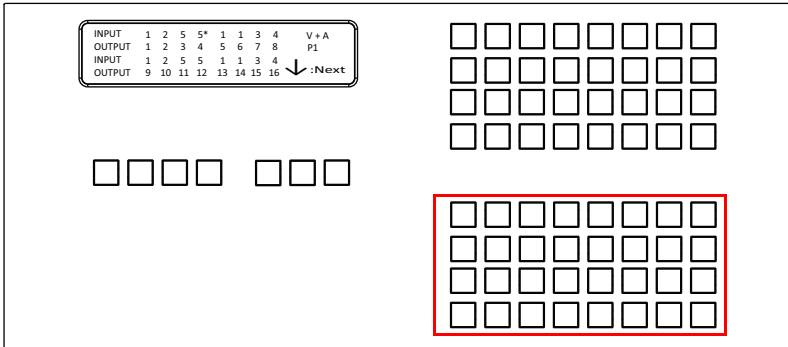

To select which output display corresponds to each input source, do the following:

1. Press any Output port pushbutton (1-32). The selected Output port LED lights steady.

In the example below, Output port **1** pushbutton has been pressed. Available Input ports light up. Because no Input LEDs are flashing, no ports have already been assigned to Output port **1**.



2. If an Output port pushbutton is pressed a second time, it is deselected and the LED turns off.
3. To connect the selected Output port(s) to an Input port, press the Input port pushbutton to which you want the Output port(s) tied. The newly selected Input port LED flashes (0.5 sec on, 0.2 sec off), and the LCD information is updated.

In the example below, pressing Input port **2** ties it to Output ports **2, 3** and **4**.



- To switch Output ports **2**, **3** and **4** to another Input port (and disconnect it from Input port **2**), press another Input port pushbutton to which you want them tied.

In the example below, Input port **3** has been pressed and is now connected to Output ports **2**, **3** and **4**.



- 
- Note:**
- Pressing an Output port a second time deselects it.
  - Pressing the **Cancel** pushbutton once stops the Output Port Selection operation, and the LCD displays the active setting. Pressing the **Cancel** pushbutton again turns all LEDs off.
  - After 10 seconds of inactivity, all the LEDs turn off.
-

## Profile Pushbutton

From the Main screen; pressing the **PROFILE** pushbutton switches between the connection profiles added to the Profile Selection list (see *Profile List*, page 59). If a connection profile is in use, it is shown from the Main screen on the lower right corner of the LCD display.

INPUT	1	2	5	5*	1	1	3	4	V + A P1
OUTPUT	1	2	3	4	5	6	7	8	
INPUT	1	2	5	5	1	1	3	4	
OUTPUT	9	10	11	12	13	14	15	16	↓ :Next



- ◆ Use the front panel number pushbuttons to select a profile:
  - ◆ **Input** ports 1–32 correspond to Profile **P1** to **P32**
  - ◆ **Output** ports 1–32 correspond to Profile **P33** to **P64**

---

**Note:** If a Profile is available for selection, its corresponding Input/Output port LED lights.

---

The selected pushbutton lights steady, and the VM3200 immediately applies the port connections configured in the Profile. The selected Profile is shown as **P1-P64** in the LCD's lower right corner.

- ◆ **Up** and **Down** buttons correspond to the previous or next profile in the Profile List, which can be edited via the GUI.

If there are no profiles configured, an error message “*No Profile List defined. Profile List can be edited via the Web GUI.*” is displayed.

- ◆ The Profile List and connections can be edited from the *Profile List* page of the Browser GUI. See *Profile List*, page 59.
- ◆ Press the **Cancel** pushbutton to turn off the Profile LED.
- ◆ Pressing the **Profile** pushbutton for longer than 3 seconds displays the Save to a Profile page (see *Saving Configurations to Profile*, page 54).

---

**Note:** To save a configuration to a profile using the Front Panel pushbuttons, follow the steps in *Saving Configurations to Profile*, page 54.

---

## LCD Menu

Use the **Menu** pushbutton to switch between the Main Screen and Menu page. From the Main Screen press the **Menu** pushbutton to access the Menu page; use the pushbuttons (1-32) to cycle through the menu options, starting from IP Setting, in the order show in the table below:

Menu Page	Sub-Menu Page(s)			
IP Setting	IP Address			
	Subnet Mask			
	Gateway			
Serial Port Setting	Baud Rate	9600 / <b>19200</b> / 38400 / 115200		
Operation Mode	EDID	<b>Default</b> / Port1 / Remix / Customized		
	CEC	On / <b>NA</b>		
	OSD	On / NA		
	Output Status	Video	<b>On</b> / NA	
		Stereo Audio	01-32	
Output Resolution		01-32		
Security Mode	Mode	<b>None</b>		
		Password Enable		
		Lock Screen		
	Change Password	Old Password	New Password	
Save to a Profile	Save to a Profile No.	01-32		
Play/Stop the Profile Schedule				
Turn Video Wall Off				

**Note:** 1. The highlighted values are the default settings of the VM3200.

2. Upon VM3200 startup, check the front panel LCD to view the loading progress. If the LCD Menu fails to load, an error message displays. Reset the unit and try again.



## LCD Main Screen

The Main Screen shows the Input–Output port pairs, with the Output ports shown in sequential order (1–16) at the bottom half.

INPUT	1	2	5	5*	1	1	3	4	V + A
OUTPUT	1	2	3	4	5	6	7	8	
INPUT	1	2	5	5	1	1	3	4	
OUTPUT	9	10	11	12	13	14	15	16	↓: Next

- ◆ The front panel pushbutton label (1–32) corresponds to the **Input** ports and **Output** ports on the unit’s rear panel.
- ◆ Use the **Down** pushbutton to go to the next page to view ports 17–32.
- ◆ Use the **Menu** pushbutton to go to the Menu page.
- ◆ Use the **Profile** pushbutton to switch between profile connections (see *Profile List*, page 59).

## IP Setting

---

To view the VM3200's IP settings, press the **Menu** pushbutton (lights). This takes you to the Menu page, shown below:

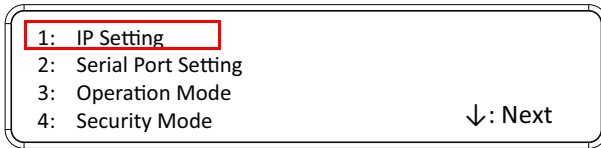

1. From the Menu page:
  - ◆ Press **1** to go to the IP Setting page.
  - ◆ Press **2** to go to the Serial Port Setting page.
  - ◆ Press **3** to go to the Operation Mode page.
  - ◆ Press **4** to go to the Security Mode page.
  - ◆ Press **Down** button to go to the next page.
  - ◆ Press **Menu** to return to the Menu Screen.
  - ◆ Press **Cancel** to return to the Main Screen.
2. After pressing **1**, the IP address, Subnet Mask and Gateway information are shown:

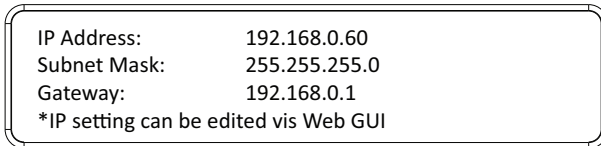

- ◆ The default IP address is 192.168.0.60.
  - ◆ The default Subnet Mask is 255.255.255.0.
  - ◆ The default Gateway is 192.168.0.1.
3. Press **Cancel** to return to the previous step without change.

## Serial Port Setting

---

To configure the VM3200's serial port settings, select Serial Port Setting from the Menu page.

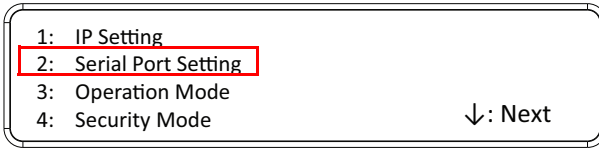

### Baud Rate

1. Select **Baud Rate Setting** from the Serial Port Setting by pressing **1**:

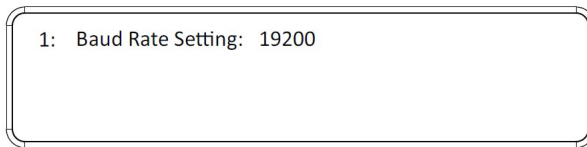

2. Press pushbuttons 1–4 to make your selection.

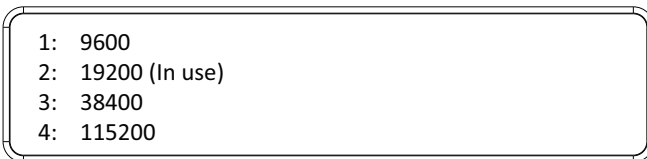

Baud Rate options are:

- ◆ 1: 9600
- ◆ 2: 19200
- ◆ 3: 38400
- ◆ 4: 115200

---

**Note:** The default baud rate is 19200.

---

3. Press **Menu** to return to the Menu page.
4. Press **Cancel** to return to the previous step without saving.

## Operation Mode

---

The EDID, CEC, OSD, and Output Status features are adjusted from the Operation Mode menu.

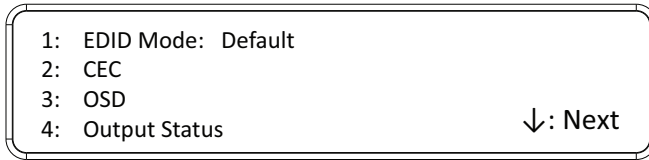

- ◆ EDID (extended display identification data) is used to apply a preset video configuration (EDID Mode), which utilizes the best resolution across different monitors.
- ◆ Consumer Electronics Control (CEC) allows interconnected HDMI devices to communicate and respond to one remote control.
- ◆ The OSD, when enabled for a port, displays real-time port switching information on the screen.
- ◆ The Output Status shows whether the video/audio of an Output port is turned on or off.

### EDID

To adjust the EDID mode, do the following:

1. From the Operation page, press pushbutton **1** to access the EDID Mode page:

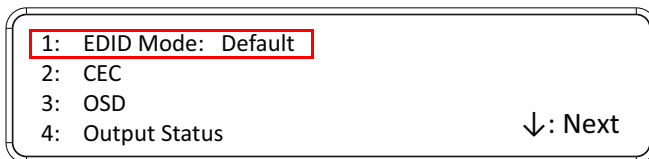

2. Press pushbuttons 1-4 to make your selection.

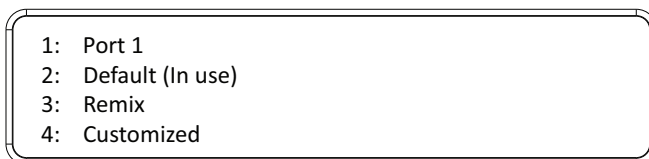

EDID Mode options are:

EDID Option	Description
1: Default	ATEN's default EDID data is passed to all video sources by default when the system is powered on.
2: Port1	EDID data read from port 1 is passed to all video sources. The system will enforce the Default EDID setting if port 1 is not occupied.
3: Remix	This mode reads the EDID data from all connected displays and generates the optimum EDID for all video sources. The system will not re-generate a new EDID when a new device is plugged in, unless triggered by a pushbutton or command.
4: Customized	This mode features an EDID Wizard that allows user-defined EDID configurations for optimum output. See <i>Customized Mode</i> , page 100.

3. Press **Menu** to return to the Menu page.
4. Press **Cancel** to return to the previous step without change.

---

**Note:** The default EDID setting is Default.

---

## CEC

To configure the CEC settings, do the following:

1. From the Operation page, press pushbutton **2** to access the CEC page:

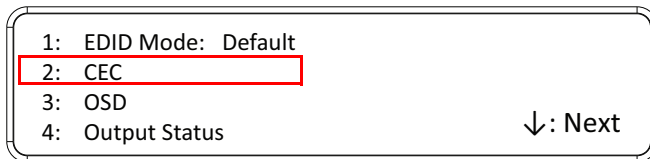

2. Press pushbuttons 1–32 to enable (**ON**) or disable (**NA**) the CEC feature for the output port. If the port does not support CEC, an **NA** is shown.

OUTPUT	1	2	3	4	5	6	7	8
	NA	NA	NA	NA	ON	NA	ON	NA
OUTPUT	9	10	11	12	13	14	15	16
	ON	ON	ON	ON	NA	NA	NA	NA

↓: Next

---

**Note:** The default CEC setting is Off.

---

3. Press **Menu** to return to the Menu page.
4. Press **Cancel** to return to the previous step without saving.

### OSD

The On-Screen Display or OSD feature enables real-time text updates to appear on the display device’s screen for any configuration changes made to the Output port via the VM3200’s front panel, remote control or Web GUI.

To configure the OSD setting for each output port, do the following:

1. From the Operation page, press pushbutton **3** to access the OSD page:

1: EDID Mode: Default
2: CEC
3: OSD
4: Output Status

↓: Next

2. Press pushbuttons 1–32 to enable (**ON**) or disable (**NA**) the OSD feature for the port.

OUTPUT	1	2	3	4	5	6	7	8
	NA	NA	NA	NA	ON	NA	ON	NA
OUTPUT	9	10	11	12	13	14	15	16
	ON	ON	ON	ON	NA	NA	NA	NA

↓: Next

---

**Note:** The default OSD setting is Off.

---

3. Press **Menu** to return to the Menu page.

4. Press **Cancel** to return to the previous step without saving.

### Output Status

To configure the Output Status settings for each output port, do the following:

1. From the Operation Mode screen, press pushbutton **4** to access the Output Status page:

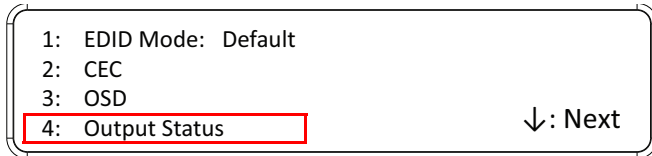

2. Press pushbuttons 1–3 to select whether you want to configure the video, stereo audio, or output resolution for output ports.

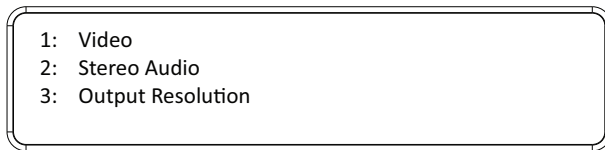

3. If configuring the output port status for video, press pushbuttons 1–32 to enable (**ON**) or disable (**NA**) the video channel:

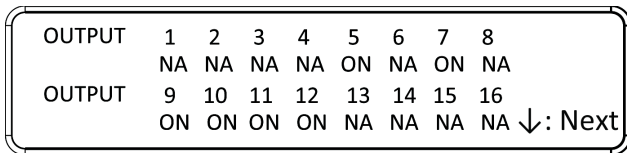

---

**Note:** The default Output Status setting is On.

---

- If configuring the output port status for stereo audio, press pushbuttons 1–32 to select the output port. Adjust the audio volume for the port by pressing the **Up** or **Down** pushbutton:

OUTPUT	1	2	3	4	5	6	7	8
	NA	NA	NA	NA	ON	NA	ON	NA
OUTPUT	9	10	11	12	13	14	15	16
	ON	ON	ON	ON	NA	NA	NA	NA ↓: Next

---

**Note:** The audio volume range from 0 (mute) and 1 (~27dB) to 10 (0dB).  
The default audio volume is 10.

---

- If configuring the output video resolution, press pushbuttons 1–32 to select the output port. Next, select the preferred output resolution.
- Press **Menu** to return to the Menu page.
- Press **Cancel** to return to the previous step without saving.



## Security Mode

---

The Security Mode page allows you to configure the VM3200's password-related settings; the **Password** page sets the VM3200 to require a password for local operation after the LCD display times out (default time out: 5 minutes) or is powered off/on. The **Change Password** option allows you to set a new password for the VM3200.

To configure the VM3200's password settings from the Main Screen, use the **Menu** pushbutton to access the Menu page, then press pushbutton **4** to access the Security Mode page.

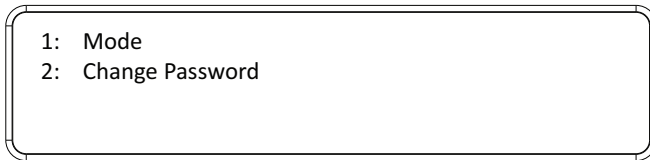

### Mode

1. To set the VM3200 so that it requires a password for local operation, press pushbutton **1** in the Security Mode page.

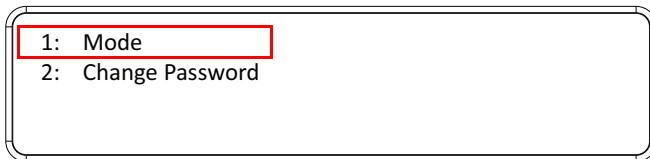

2. To disable security settings, press pushbutton **1**.
3. To require a password after the LCD display times out or is powered off/on, press pushbutton **2**.

- To enable a lock screen, press pushbutton **3**. When Lock Screen is enabled, pressing any pushbutton from the home screen will trigger the following message: *Please press "Menu" to start.*

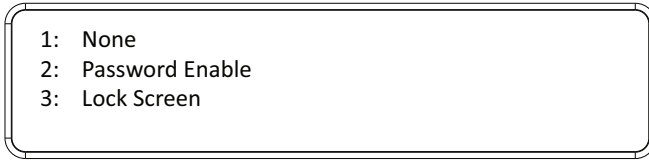

---

**Note:** By default the password requirement is disabled. If the password is enabled, the LCD display's default time-out is 5 minutes.

---

- Press **Menu** to return to the Menu page.
- Press **Cancel** to return to the previous step without saving.

### Change Password

- To change the password: from Security Mode, press pushbutton **2**.

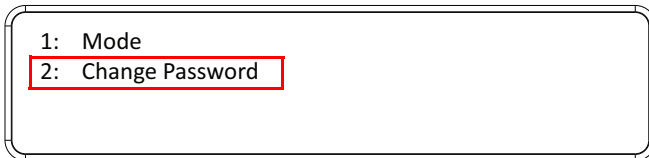

- In the Old Password field, the cursor flashes at the first digit. Enter the old password (see *LCD Password*, page 34). If the old password is entered correctly, you can proceed to the next step. The default password is: **1234**.

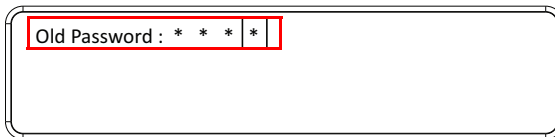

---

**Note:** If you enter an incorrect password, the cursor goes back to the first digit and reverts to flashing. The Incorrect Password message clears as soon as a new digit is entered.

---

3. In the New Password field, the cursor flashes at the first digit. Enter the new password using the front panel number pushbuttons (1111–9999).



A screenshot of a terminal screen showing a password change interface. The text "Old Password : \* \* \* \*" is displayed on the first line. The second line shows "New Password:" followed by a cursor in a box and three asterisks. A red rectangular box highlights the cursor and the first asterisk.

4. Re-enter the new password in the following screen. The new password is applied by the VM3200 immediately.

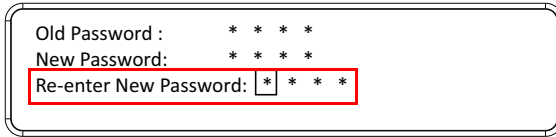

A screenshot of a terminal screen showing a password re-entry interface. The text "Old Password : \* \* \* \*" is displayed on the first line. The second line shows "New Password: \* \* \* \*". The third line shows "Re-enter New Password:" followed by a cursor in a box and three asterisks. A red rectangular box highlights the cursor and the first asterisk.

If the password you entered does not match the one entered in the previous screen, an error message appears. Enter the new password correctly.

5. Press **Menu** to return to the Menu page.
6. Press **Cancel** to return to the previous step without saving.

## Saving Configurations to Profile

---

The VM3200 allows you to store up to 64 (P1–P64) different connection profiles that can be saved and recalled later. When profiles are saved, they are saved according to the current connection configuration on the Main Screen. When you load a profile, the change is immediate and the profile number is shown in the lower right corner of the LCD display. To save profiles, from the Main Screen do the following:

1. Use the **Menu** pushbutton to access the Menu page, and **Down** to navigate to the next page. Press pushbutton **1** to open the Save to a Profile page.

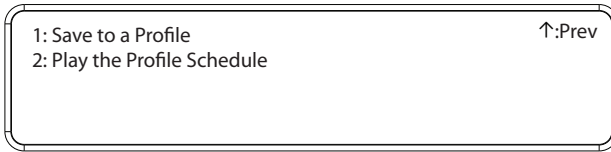

2. To save the active connection configuration as a profile use the front panel number pushbuttons to select a profile into which you want to save the configuration.

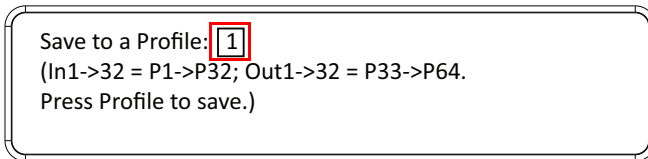

- ◆ Input ports **1–32** correspond to Profile **P1** to **P32**
  - ◆ Output ports **1–32** correspond to Profile **P33** to **P64**
3. Press the **Profile** pushbutton to store the connection configuration – the LCD shows a Profile Saved message.
  4. Press **Menu** to return to the Menu page.
  5. Press **Cancel** to return to the previous step without saving.

---

**Note:** You can also access the Save to a Profile page by pressing the **Profile** pushbutton for longer than 3 seconds.

---

---

## Playing/Stopping the Profile Schedule

---

Inputting port pushbutton **2** will Play or Stop the active Profile Schedule.

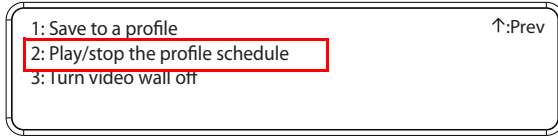

---

## Turning Video Wall Off

---

If a video wall is currently playing, a submenu will appear.

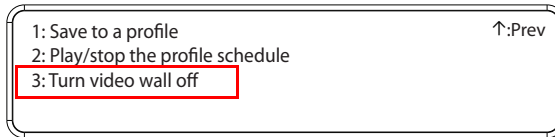

Selecting **Turn Video Wall Off** will return port assignments to their default (i.e. disassemble the video wall).

This Page Intentionally Left Blank

# Chapter 4

## Browser Operation

### Overview

---

The VM3200 can be configured over a standard TCP/IP connection via its built-in Graphical User Interface (GUI). Because it can be accessed from anywhere over a network or the Internet, operators can easily log in via web browser. Security is ensured by password protection and user-configurable time-out. The VM3200 supports three levels of remote users with various privileges, and up to 16 users can log into the GUI at one time. For full details see the sections that follow.

### Logging In

---

To access the GUI, type the VM3200's IP address into the address bar of any browser. If a Security Alert dialog box appears, accept the certificate – it can be trusted. The login screen appears:

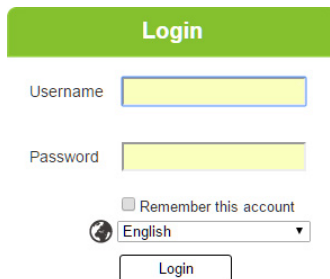

Username

Password

Remember this account

 English

Login

- ◆ The default IP address is **http://192.168.0.60**
- ◆ The default Username and Password are: **administrator / password**
- ◆ Enter the username and password, then click **Login**.
- ◆ Check **Remember this account** to save the Username and Password.
- ◆ Use the drop-down menu to select the GUI language

---

**Note:** 1. The username supports lower case letters only.

2. The same user can not be logged in simultaneously.

---

# Main Page

The Main Page opens to the **Profile List**. This is where you configure the input to output connections by creating profiles. The page is divided into three parts: the *Menu Bar*, *Profile List*, and *Profile Scheduling*.

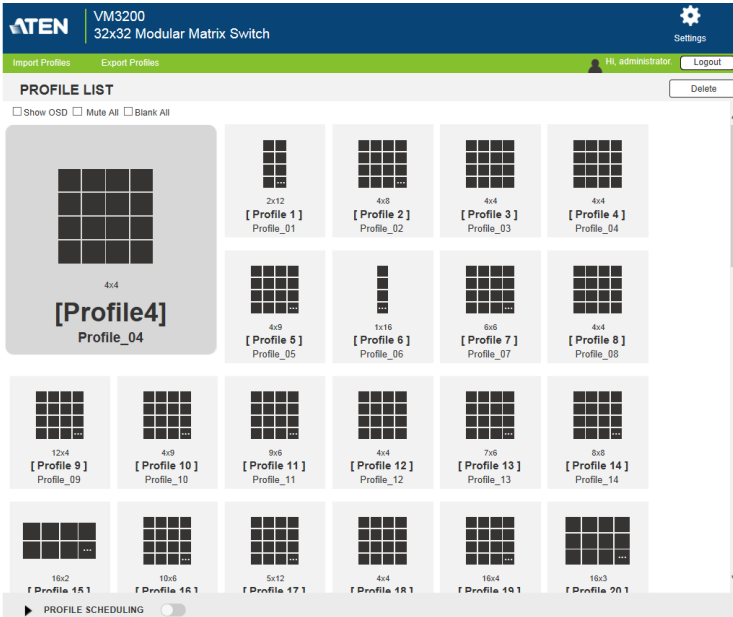

## Menu Bar

The Menu Bar consists of the *Settings* icon and *Logout* button.

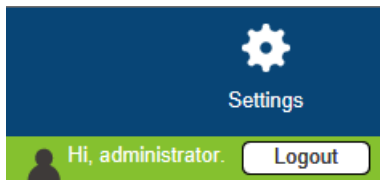

- ◆ Click **Settings** to enter the System Settings (see page 87).
- ◆ Click the **Logout** button to log out of the GUI.



## Profile List

The *Profile List* lets you configure the input to output port connections by creating profiles to use. You can store up to 64 differently configured profiles that can be saved and played later by two methods: locally via the unit's front panel pushbuttons and via the web GUI.

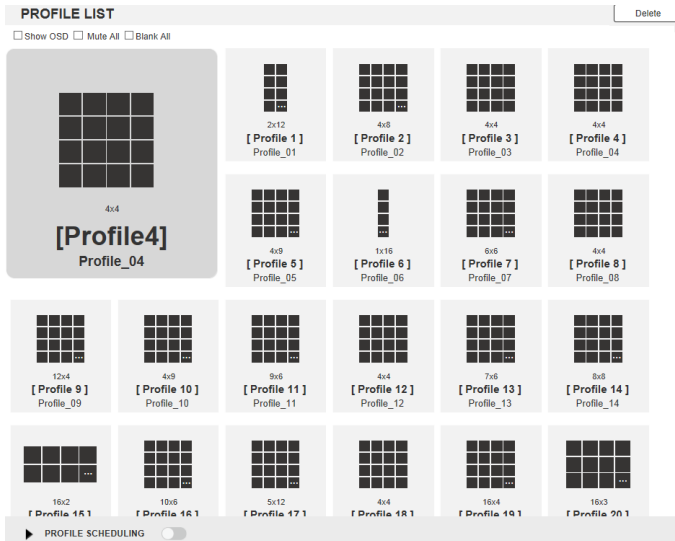

### Adding/Playing a Profile

To configure a new or existing connection profile:

1. From the Profile List, click an empty or existing **[Profile]** icon.

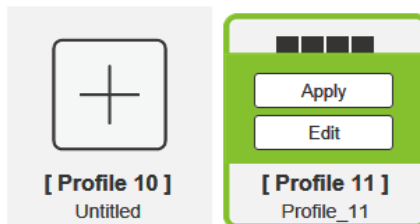

2. Configure the input to output connections and save the profile (see page 64 for details).
3. Once you create a profile, it appears in the *Profile List*.

4. Select the profile and click **Apply**.

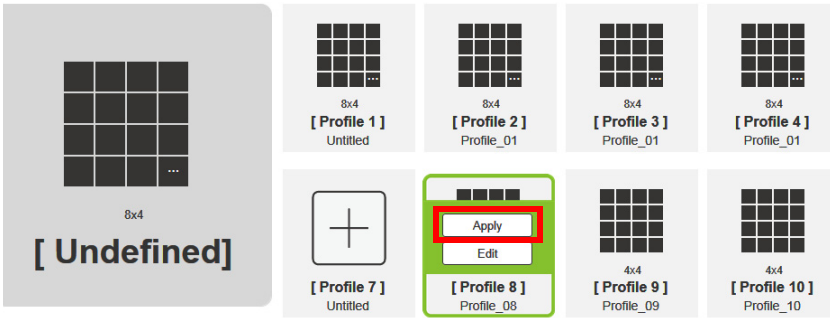

5. The profile appears in the large **Play** window and the connections start:

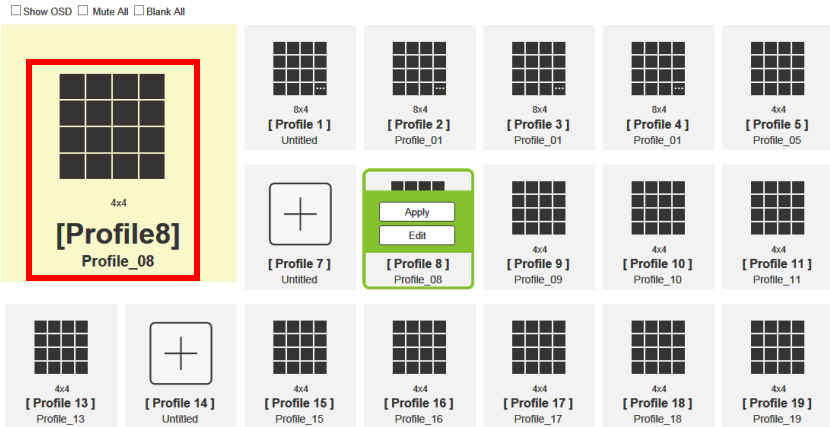

---

**Note:** More information about the Profile List is provided on the next page.

---

## Importing/Exporting a Profile

You can import and export a database file containing the complete list of connection profiles using the menu bar icons shown below:

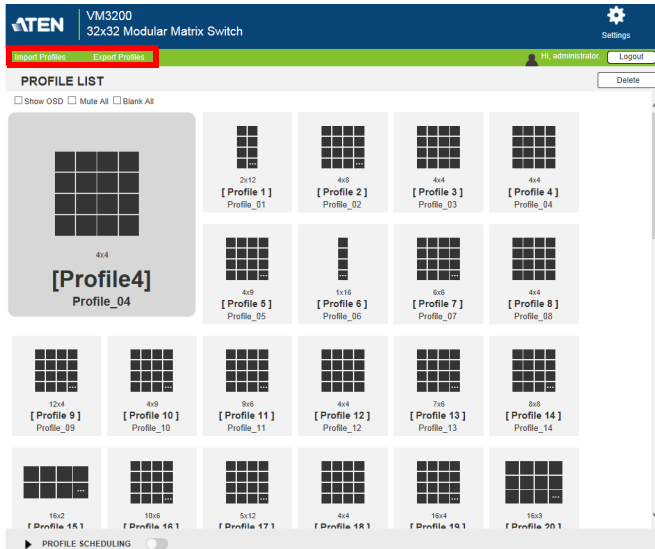

To export the VM3200's connection profiles, do the following:

1. Click **Export Profiles**. A configuration file will then begin downloading.

To import connection profiles to the VM3200, do the following:

1. Click **Import Profiles**.
2. Browse to the configuration file, select it and click **Open**.

---

**Note:** Importing a connection profile database will overwrite the current profiles.

---

## Profile List Options

Clicking on a *Profile* or the *Play* window opens a pop-up menu with options.

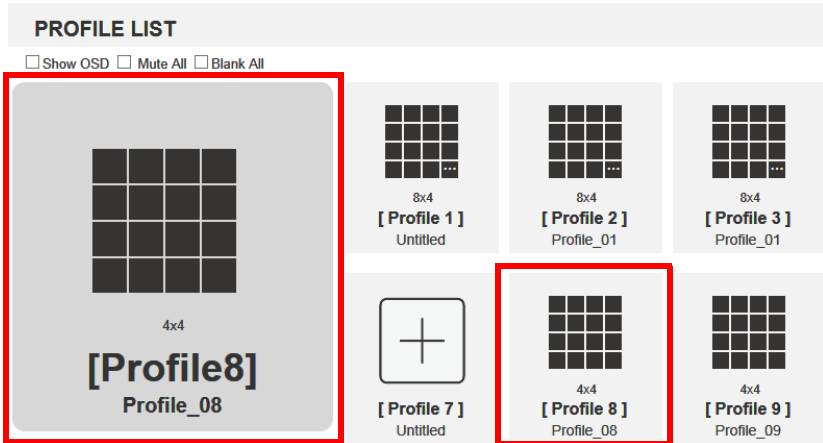

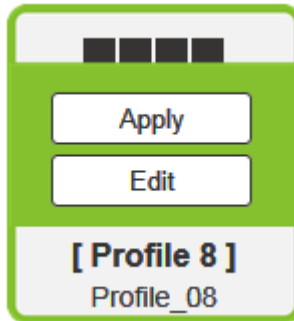

## Profile

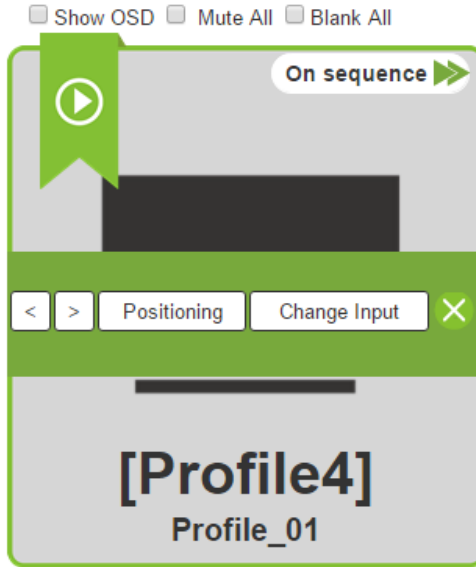

Option	Description
Apply	Click <b>Apply</b> to put the profile in the Play window. This allows you to start the profile connections.
Edit	Click <b>Edit</b> to configure the profile's input to output connections.

## Play Window



Option	Description
Show OSD	Check <b>Show OSD</b> to show the current connection status via OSD. When <b>Show OSD</b> is unchecked, the OSD will disappear.
Mute All	Check <b>Mute All</b> to mute the audio for all ports.
Blank All	Check <b>Blank All</b> to turn off the video to all displays.
On Sequence	<b>On Sequence</b> will appear when a profile schedule is playing (see see <i>Profile List Options</i> , page 62).
<	Click < to go back to the previous profile in the sequence, when Profile Scheduling is in use. Only available with <i>On Sequence</i> .
>	Click > to advance to the next profile in the sequence, when Profile Scheduling is in use. Only available with <i>On Sequence</i> .
Positioning	Click <b>Positioning</b> to open a window that allows you to adjust the image position on each display. For Video Wall profiles, you can also set the Bezel Dimension, which is the frame thickness between each display.
Change Input	Click <b>Change Input</b> to change the input for single and grouped outputs, as explained on the next page.
	Removes the profile from the Play window.

## Change Input

The *Change Input* page gives you a preview of what's displayed on all screens, allows you to change the inputs and view a live stream of each input. To access this page, click **Change Input** from the Play Window (see *Play Window*, page 63).

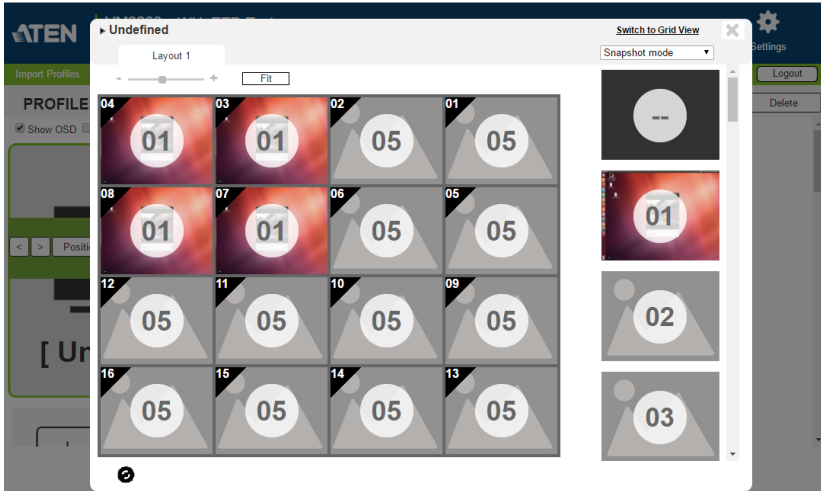



The *Change Input* page displays still image frames of output configuration, the left panel shows the profile's output configuration, and the right column lists the available inputs. The page provides the following options:

- ◆ To change the input of a display, **Drag and Drop** an input from the right column to any output in the left panel.
- ◆ Click **Switch to Grid View** to use the grid view to change the input and output connections (see *Grid View*, page 77).
- ◆ Use the drop-down menu to show the input ports in **Snapshot** or **List mode**.
- ◆ Use the slide bar to zoom the layout in (+) or out (-). Click **Fit** to set the layout to the default view.
- ◆ Click any input in the right column to view a live stream of the video source.
- ◆ Click on the refresh icon,  to refresh the *Change Input* page.

## Live Streaming View

This window gives you a live stream of the video source. To access this page click an input from the right column on the *Change Input* page (see *Change Input*, page 64).



Option	Description
	Click the icon to increase / decrease the size of the live preview window.
	Click the drop down menu to change the resolution, the available resolutions are, 1080P / 720P / 480P.
	Click on the icon, to close the window.

## Profile Scheduling

*Profile Scheduling* is located below the Profile List. Scheduling allows you to queue and play connection profiles via a calendar view for a specific amount of time.

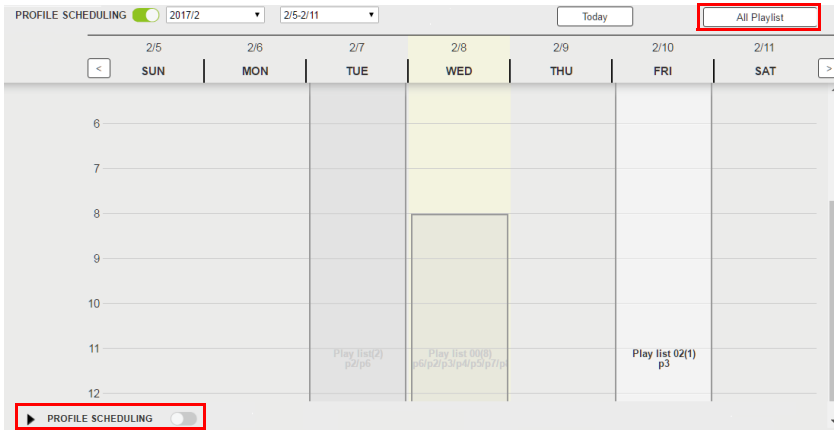



## Adding Profiles

Select **All Playlist** on the *Profile Scheduling* page, and then click **Add Playlist**, a window opens to add profiles.

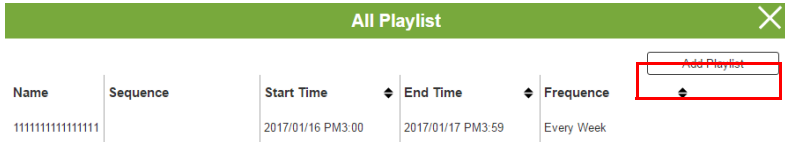

A new window will open to create schedule. You can select up to 20 profiles, then click **OK**.

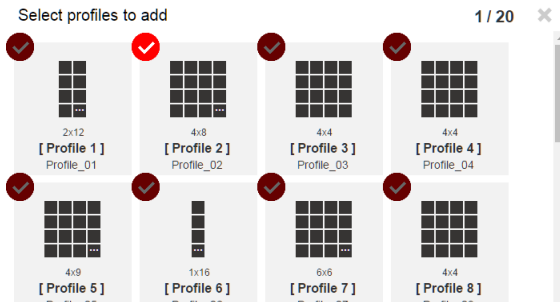

## All Playlist

Manage all playlists on the Profile Scheduling by selecting **All Playlist**. A new window opens; the options are: **Name**, **Sequence**, **Start Time**, **End Time**, **Frequency**.

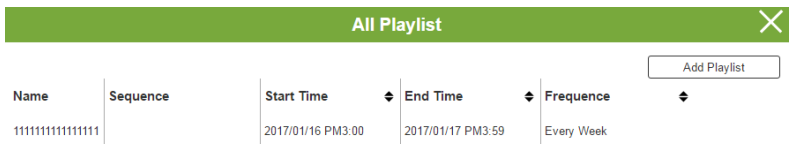

## Editing Profile Scheduling

After adding profiles to Profile Scheduling, the following options are available:

Add Playlist ✕

Name:   All Day

Start Time:     :

End Time:     :

Frequency:

Startup



4x4  
[Profile 1]  
Profile\_01

+

Option	Description
	<p>Click to add a profile to the schedule. The schedule plays profiles in order from left to right. Use the options under each profile to configure the duration of each profile being played (see below).</p>
<div style="border: 1px solid gray; padding: 2px; margin-bottom: 5px;">Repeat ▾</div> <div style="border: 1px solid gray; padding: 2px; margin-bottom: 2px;">Hour(s)</div> <div style="border: 1px solid gray; padding: 2px; margin-bottom: 2px;">Minutes</div> <div style="border: 1px solid gray; padding: 2px; margin-bottom: 2px;">Seconds</div> <div style="border: 1px solid gray; padding: 2px; margin-bottom: 2px;">Repeat</div> <div style="border: 1px solid gray; padding: 5px; text-align: center; margin-top: 10px;">0</div>	<p>Use the drop-down menu to select <b>Hour(s)</b>, <b>Minutes</b>, or <b>Seconds</b> and then enter a duration (1-999) for the profile to play. After the time expires, the schedule switches to the next profile in the list.</p> <p>Use <b>Repeat</b> to stop the schedule and stay on a particular profile. If <b>Repeat</b> isn't used, the schedule loops back to the first profile. If <b>Repeat</b> is selected for a profile, the number of hours, minutes and seconds cannot be set and any profiles added after this one will not be played.</p>
<div style="border: 1px solid gray; padding: 2px; margin-bottom: 2px;">Only Once ▾</div> <div style="border: 1px solid gray; padding: 2px; margin-bottom: 2px;">Only Once</div> <div style="border: 1px solid gray; padding: 2px; margin-bottom: 2px;">Every Day</div> <div style="border: 1px solid gray; padding: 2px; margin-bottom: 2px;">Weekday</div> <div style="border: 1px solid gray; padding: 2px; margin-bottom: 2px;">Every Week</div>	<p>Use the drop-down menu to select <b>Only Once</b>, <b>Every Day</b>, <b>Weekday</b> or <b>Every Week</b> and then enter a duration (1-999) for the profile to play. After the time expires, the schedule switches to the next profile in the list.</p>
<div style="border: 1px solid gray; padding: 5px; margin-bottom: 5px;"> <input type="radio"/> Startup         </div> <div style="border: 1px solid gray; padding: 5px; margin-bottom: 5px;"> <div style="display: flex; justify-content: space-between; align-items: center;"> <span>Replace</span> <span>Remove</span> </div> <div style="text-align: center; margin-top: 5px;"> <div style="border: 1px solid gray; padding: 2px; display: inline-block;">[Profile 3] Profile_03</div> </div> <div style="display: flex; justify-content: space-between; align-items: center; margin-top: 5px;"> <input type="text" value="3"/> <input type="text" value="Minutes"/> </div> </div> <div style="display: flex; align-items: center; gap: 10px; margin-top: 5px;"> <span>&lt;</span> <span>&gt;</span> </div>	<p>Click a profile to open the pop-up menu:</p> <ul style="list-style-type: none"> <li>◆ Select <b>Startup</b> to set a profile as the starting point each time the schedule is played.</li> <li>◆ Click <b>Replace</b> to replace the selected profile with another profile.</li> <li>◆ Click <b>Remove</b> to delete the profile from the schedule.</li> <li>◆ Use <b>&lt;</b> <b>&gt;</b> to change the profile's position in the schedule.</li> </ul>

---





Option	Description
Save	Click <b>Save</b> to save the schedule as it appears. After saving, the Profile Scheduling window stays open allowing you to <b>Play</b> or <b>Edit</b> the schedule. When a Profile Schedule is playing the <i>On Sequence</i> box will appear in the Play window.
Cancel	Click <b>Cancel</b> to discard changes and return to the Profile Schedule page.

---

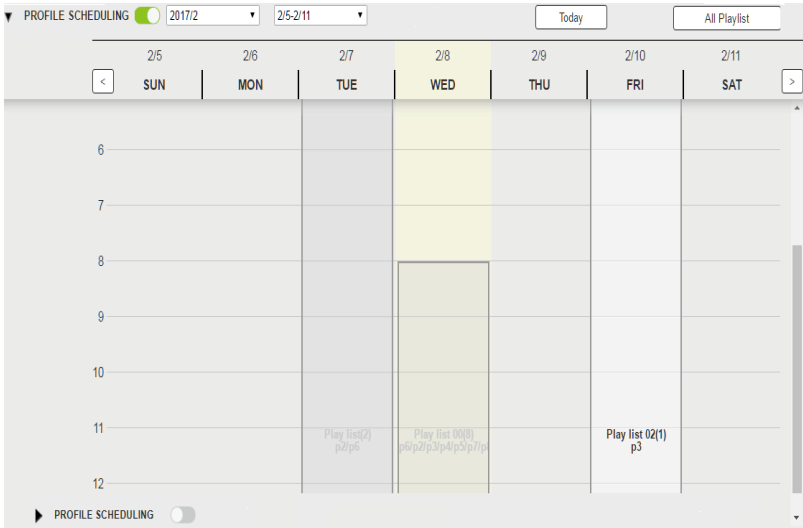
## Playing Profile Scheduling

When *Profile Scheduling* is ready to play, you are provided with the following calendar view:

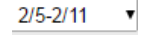

Option	Description
	Click on / off switch to turn on / off profile scheduling
	Click open to view <b>All Playlists</b>
	Click on the Today button to go to current week period.
	Click the previous week or next week icons, to scroll through the calendar
	Select a month to view from the drop down menu
	Select a week to view from the drop down menu

## Connection Profiles

Connection profiles configure the source to display connections. You can create up to 64 connection profiles that can be selected for use at any time. The configuration page opens after you click to add or edit a profile from the Profile List (see *Profile List*, page 59).

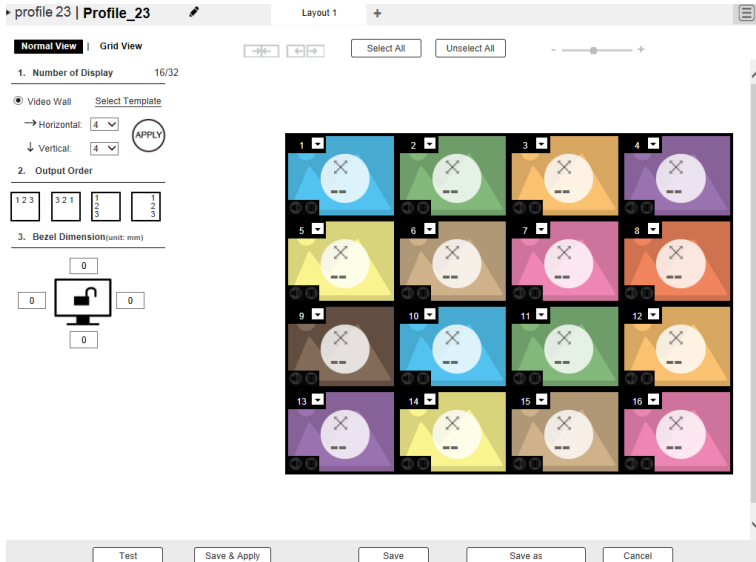

The Configuration page is comprised of the *Side Panel*, *Main Page*, *Top Bar*, and *Bottom Bar*.

### Layout Type

To configure the connections first choose the layout type from the Side Panel:

- ◆ **Video Wall** is for displays that are tiled together, where multiple monitors form one large screen – in various arrangements.
- ◆ **Select a Template** Is for selecting a predetermined layout; a *Select Template* window opens up. The seven templates are: **All in one**, **Split screens 1**, **Split screens 2**, **Quad view**, **Half & half 1**, **Half & half 2** and **pip**.

After choosing the layout type you can configure the input port to output port connections on the *Main Page*, as described on the pages that follow.

## Side Panel

The *Side Panel* sets up the layout type for the *Video Wall*(see *Layout Type*, page 71). When you **Apply** changes in the Side Panel, the Main Page layout changes to match that of the settings.

1. Number of Display 16/32

---

Video Wall [Select Template](#)

→ Horizontal:

↓ Vertical:

2. Output Order

---

3. Bezel Dimension(unit: mm)

---

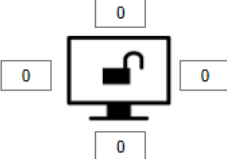

Option	Description
Number of Displays	<p>Choose the layout type and configure the number of displays:</p> <ul style="list-style-type: none"> <li>◆ <b>Video Wall</b>: Select for displays that are tiled together, where multiple monitors form one large screen – in various arrangements.                             <ul style="list-style-type: none"> <li>◆ Click <b>Select Template</b> to open a window that allows you to select a predefined video wall layout.</li> <li>◆ Use the <b>Horizontal</b> and <b>Vertical</b> drop-down menu to select the number of displays that make up the video wall (a maximum of 64 are supported). Match this to the physical layout of the displays.</li> </ul> </li> <li>◆ Click <b>Apply</b> to set the layout.</li> </ul>
Output Order	<p>Automatically assign output ports by selecting one of the following options: Left to right (top to bottom), right to left (top to bottom), top to bottom (left to right) or top to bottom (right to left).</p>
Bezel Dimension	<p>Use the four boxes to increase/decrease the frame size for each active display.</p>

---

Option	Description
Monitor Lock / Unlock 	Click the monitor icon to <b>Lock</b> the (4) bezel settings, so that when one size is changed they all change. Click the monitor icon to <b>Unlock</b> the (4) bezel settings, so that each size can be set independently.

---

## Main Page

The *Main Page* has Output icons that represent the physical displays. Each icon allows you to configure a displays input port, output port and other options. The number and arrangement of Output icons depends on the Side Panel settings (see *Side Panel*, page 72). Instructions are provided for Video Wall layout.

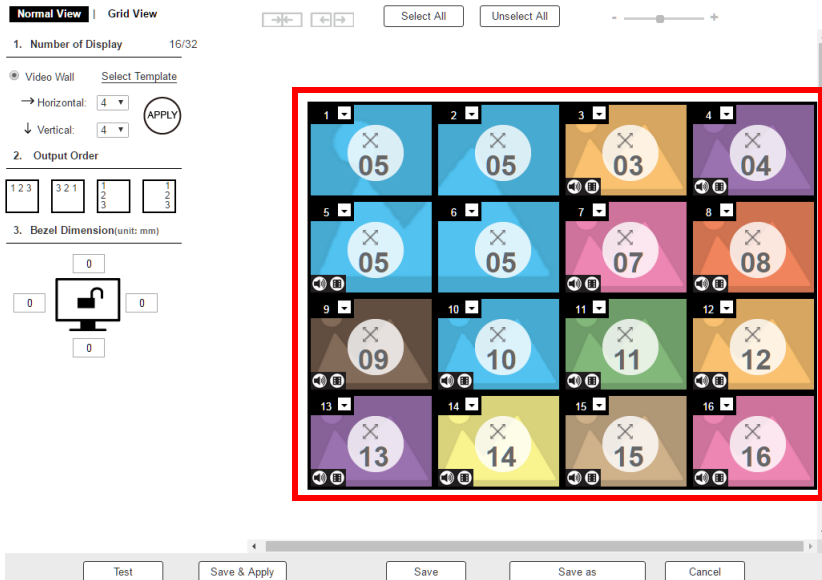



## Output Icon



Option	Description
Output Icon	<p>Click an Output icon(s) to highlight it in green and use the <i>Display Preferences</i> menu to set the video and audio input options (see <i>Display Preferences</i> below).</p> <p>The large number is the <b>Video Input</b> port selected for the display.</p> <p>The drop-down menu in the upper-left corner is used to select the <b>Output</b> port of the display.</p> <p>The arrows show the Scale option selected from <i>Display Preferences</i> for the output port.</p>
Mute / Video	<p>Click the <b>speaker</b> icon to mute the audio on/off.</p> <p>Click the <b>video</b> icon to turn the video off/on.</p>

## Display Preferences

**Display Preference**



---

Output: 1\_Port\_Out\_1 ▼

Video Input: 5\_Port\_In\_5 ▼ 

Audio Input: 5\_Port\_In\_5 ▼ 

Fit Width of Output(s)  
 Fit Height of Output(s)  
 Scale to Whole Output(s)

Option	Description
Display Preferences	The Display Preferences menu appears when you click an <b>Output</b> icon.
Output	Use the drop-down menu to select the <b>Output Input</b> port.
Video Input	Use the drop-down menu to select the <b>Video Input</b> port.
Audio Input	Use the drop-down menu to select the <b>Audio Input</b> port.
Live Streaming 	Use the <i>Input</i> drop-down menu and click on the icon to view live streaming.
Lock / Unlock 	<b>Lock</b> the icon to set the same source for the Video/Audio Input: when one is changed the other changes to match it. <b>Unlock</b> the icon to set different sources for the Video and Audio port.
Radio Button	<ul style="list-style-type: none"> <li>◆ <b>Fit Width of Output(s)</b>: fits the video to the width of the display.</li> <li>◆ <b>Fit Height of Output(s)</b>: fits the video to the height of the display.</li> <li>◆ <b>Scale to Whole Output(s)</b>: fits the video on the entire display.</li> </ul>

## Grid View

The Traditional View allows you to select the **Input to Output** and **Audio** connections using a simple grid.

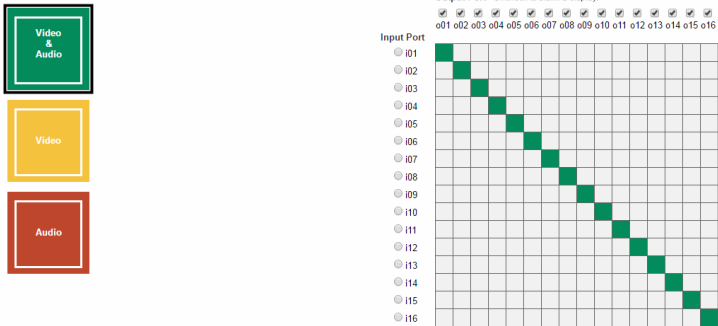

- ◆ Select: **Video & Audio**, **Video**, or **Audio** to set the input to output connection for the selected source.
- ◆ From an *Output Port* column, click a box to select its **Input Port**. The box will turn green, yellow or red.
- ◆ **Uncheck** an *Output Port* box to disable the video for that Output Port. The column will turn dark gray.
- ◆ **Check** an *Output Port* box to enable the video for that Output Port
- ◆ Click **Test** to play the current profile without saving.
- ◆ Click **Save & Apply** to save a profile and begin playing it.
- ◆ Click **Save** to save the profile.
- ◆ Click **Save as** to save the profile as a different profile number.
- ◆ Click **Cancel** to undo all unsaved changes.

## Video Wall

Each icon represents an Output port and the connected display. Use the icons to create Independent and Grouped Outputs. **Independent** Outputs will display video on a single monitor. **Grouped** Outputs will display video across multiple monitors as one large screen.

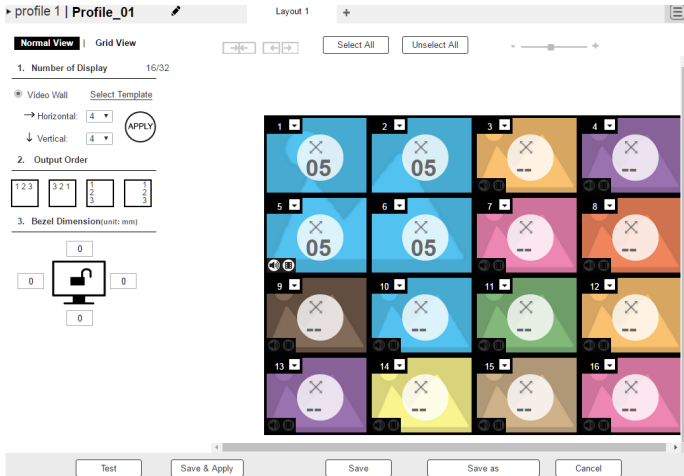

Click an icon to choose its **Output** and **Video Input** from the *Display Preference* menu (see *Display Preferences*, page 81).

- ◆ Click multiple icons to Group Outputs (see *Grouping*, page 80).
- ◆ Click **Select All** to select all outputs.
- ◆ Click **Unselect All** to unselect all outputs.
- ◆ Use the sidebar to zoom in and out of the display layout.
- ◆ On the *Top Bar* click:
  - ◆ The **PEN** icon or profile name to rename the profile.
  - ◆ **+** to add a layout to the profile.
  - ◆ The **Menu** icon for the **Output Option** page (see *Output Options*, page 84).
- ◆ On the *Bottom Bar* click:
  - ◆ **Test** to temporarily view the current connection settings.
  - ◆ **Save & Apply** to save and apply the settings.
  - ◆ **Save** to save and exit to the Profile List.
  - ◆ **Save as** to save the current settings as a different profile.
  - ◆ **Cancel** to exit without saving.

## Null Input



Option	Description
Null Icon	<p>Click Null Input icons to highlight icons in green and use the Display Preferences menu to set the video options (see <i>Display Preferences</i>, page 81).</p> <p>Select a <b>single</b> icon to set the <b>Output</b> and <b>Video Input</b> for an independent display (see <i>Independent Output</i>, page 79).</p> <p>Select <b>multiple</b> icons and set the <b>Video Input</b> to group displays as one screen (see <i>Grouping</i>, page 80). <i>You must first set the Output port for each icon.</i></p>
Drop-Down Menu	Use the drop-down menu to select the Output port.

## Independent Output



Option	Description
Independent	<p>Independent Outputs are displays that have their own <b>Video Input</b> and <b>Output</b> selected. Independent Outputs:</p> <ul style="list-style-type: none"> <li>◆ Display their own video</li> <li>◆ Icons have their own color and Video Input</li> </ul> <p>Select an Independent Output and use the <i>Display Preferences</i> menu to select the <b>Video Input</b> (see page 81).</p>
Drop-down Menu	Use the drop-down menu (top-right corner) to select the Output port.
Mute / Video	<p>Click the <b>speaker</b> icon to mute the audio on/off.</p> <p>Click the <b>video</b> icon to turn the video off/on.</p>



## Grouping



Option	Description
Grouping	Click multiple icons to Group Outputs (highlighted in green) and click → ← to group the displays into one screen. Use the <b>Display Preferences</b> menu to select the <b>Video Input</b> for the group - each Output icon in the Group will appear with the same Video Input number and icon color.
Ungroup	Select a group and click ← → to ungroup the displays.

## Group



Option	Description
Group	<p>A <b>Group</b> (of Outputs) shares the same <b>Video Input</b> and displays the video together as one large screen. A Group of Outputs:</p> <ul style="list-style-type: none"> <li>◆ Displays video across multiple monitors to form one screen.</li> <li>◆ Icons have the same color and Video Input number.</li> <li>◆ Select a Group and use the <i>Display Preferences</i> menu to select the <b>Video Input</b>.</li> <li>◆ To group outputs, see Grouping above.</li> </ul>
Mute / Video	<p>Click the <b>speaker</b> icon to mute the audio on/off.</p> <p>Click the <b>video</b> icon to turn the video off/on.</p>

## Display Preferences

**Display Preference**



---

Output:

Video Input:  

Audio Input:  

Fit Width of Output(s)  
 Fit Height of Output(s)  
 Scale to Whole Output(s)

Option	Description
Display Preferences	Click Output icons for the Display Preferences menu to appear– to select the <b>Output</b> , <b>Video Input</b> and Audio Input ports.
Output	Use the drop-down menu to select the <b>Output</b> port (Independent and single Blank icons only). If you select multiple displays the output ports selected will appear here. You can use the output icon's drop-down menu to change the output port for the display.
Video Input	Use the drop-down menu to select the <b>Video Input</b> port.
Audio Input	Use the drop-down menu to select the <b>Audio Input</b> source.
Lock / Unlock  	<b>Lock</b> the icon to set the same source for the Video and Audio Input: when one is changed the other changes to match it. <b>Unlock</b> the icon to set different sources for the Video and Audio port.
Radio Button	<ul style="list-style-type: none"> <li>◆ <b>Fit Width of Output(s)</b>: fits the video to the width of the display.</li> <li>◆ <b>Fit Height of Output(s)</b>: fits the video to the height of the display.</li> <li>◆ <b>Scale to Whole Output(s)</b>: fits the video on the entire display.</li> </ul>

### Video Wall Example 1

This example shows a video wall with 8 displays.

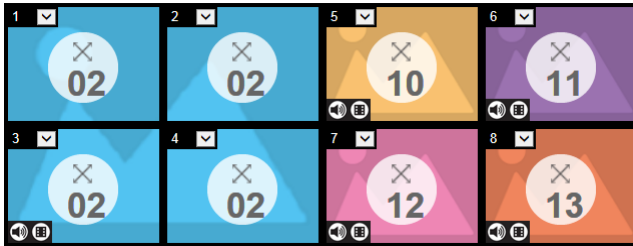

- ◆ This video wall has 1 **Group** and 4 **Independent** displays.
- ◆ Each *Group* and *Independent* Output has a unique color.
- ◆ The **Blue** Group will show video **Input 02** across all four displays as one large screen.
- ◆ The Independent displays will show the video from their own video **Input 10, 11, 12** and **13**.
- ◆ To include additional video wall layouts under the same profile, see *Video Wall*, page 78.



## Video Wall Example 2

This example shows a video wall with 16 displays.



- ◆ This video wall has 3 **Groups** and 2 **Independent** displays.
- ◆ Each *Group* and *Independent* Output has a unique color.
- ◆ The **Blue** Group will show video **Input 02** across six displays as one large screen.
- ◆ The **Brown** Group will show video **Input 10** across six displays as one large screen with a section (video *Input 16*) of the viewing area missing.
- ◆ The **Yellow** Group will show video **Input 16** across two displays as one screen.
- ◆ The **Purple** and **Orange** Independent displays will show the video from their own video **Input 08** and **12**.
- ◆ To include additional video wall layouts under the same profile, see *Video Wall*, page 78.

## Output Options

The *Output Options* page is used to configure Audio Controls and Video Control.

### Audio Control

Audio Control

Port	HDMI Control		Stereo Control		Stereo_volume		
	Apply to All		Apply to All		Apply to All		
Port1	HDMI	Use HDMI Audio	Stereo	Use Stereo Audio	+	Vol.10	-
Port2	HDMI	Use HDMI Audio	Stereo	Use Stereo Audio	+	Vol.10	-
Port3	HDMI	Use HDMI Audio	Stereo	Use Stereo Audio	+	Vol.10	-
Port4	HDMI	Use HDMI Audio	Stereo	Use Stereo Audio	+	Vol.10	-
Port5	HDMI	Use HDMI Audio	Stereo	Use Stereo Audio	+	Vol.10	-
Port6	HDMI	Use HDMI Audio	Stereo	Use Stereo Audio	+	Vol.10	-
Port7	HDMI	Use HDMI Audio	Stereo	Use Stereo Audio	+	Vol.10	-
Port8	HDMI	Use HDMI Audio	Stereo	Use Stereo Audio	+	Vol.10	-
Port9	HDMI	Use HDMI Audio	Stereo	Use Stereo Audio	+	Vol.10	-
Port10	HDMI	Use HDMI Audio	Stereo	Use Stereo Audio	+	Vol.10	-
Port11	HDMI	Use HDMI Audio	Stereo	Use Stereo Audio	+	Vol.10	-
Port12	HDMI	Use HDMI Audio	Stereo	Use Stereo Audio	+	Vol.10	-

- ◆ **HDMI / Stereo Control:** Use the drop-down menu to apply audio setting to all ports:
  - ◆ *All Ports Use HDMI Audio.*
  - ◆ *All Ports Use Stereo Audio* (uses the stereo audio port).
  - ◆ *All Mute:* mutes all ports.
- ◆ **Port\_HDMI / Stereo:** Use the drop-down menu to apply audio settings to each port:
  - ◆ *Use HDMI Audio:* port uses the HDMI audio.
  - ◆ *Use Stereo Audio:* port uses the Stereo audio.
  - ◆ *Mute:* mutes HDMI/Stereo for the selected port.
- ◆ **Stereo Volume:** Use + *and* - to increase or decrease the audio level.
- ◆ Click **Test** to try the current profile without saving.
- ◆ Click **Save & Apply** to save a profile and begin playing it.
- ◆ Click **Save** to save the profile.

- ◆ Click **Save as** to save the profile as a different profile number.
- ◆ Click **Cancel** to undo all unsaved changes.

## Video Control

*Video Control* allows you to set Seamless Switch options which determine how a display performs when the input port is changed.

Port	Seamless Switch	Transition	Period	Scale Resolution
	Apply to All ▼	Apply to All ▼	Apply to All ▼	Apply to All ▼
Port1	<input checked="" type="checkbox"/> ON	<input type="checkbox"/> OFF	▼	1920x1080@60HZ * ▼
Port2	<input checked="" type="checkbox"/> ON	<input type="checkbox"/> OFF	▼	1920x1080@60HZ * ▼
Port3	<input checked="" type="checkbox"/> ON	<input type="checkbox"/> OFF	▼	1920x1080@60HZ * ▼
Port4	<input checked="" type="checkbox"/> ON	<input type="checkbox"/> OFF	▼	1920x1080@60HZ * ▼
Port5	<input checked="" type="checkbox"/> ON	<input type="checkbox"/> OFF	▼	1920x1080@60HZ * ▼
Port6	<input checked="" type="checkbox"/> ON	<input type="checkbox"/> OFF	▼	1920x1080@60HZ * ▼
Port7	<input checked="" type="checkbox"/> ON	<input type="checkbox"/> OFF	▼	1920x1080@60HZ * ▼
Port8	<input checked="" type="checkbox"/> ON	<input type="checkbox"/> OFF	▼	1920x1080@60HZ * ▼
Port9	<input checked="" type="checkbox"/> ON	<input type="checkbox"/> OFF	▼	1920x1080@60HZ * ▼
Port10	<input checked="" type="checkbox"/> ON	<input type="checkbox"/> OFF	▼	1920x1080@60HZ * ▼
Port11	<input checked="" type="checkbox"/> ON	<input type="checkbox"/> OFF	▼	1920x1080@60HZ * ▼
Port12	<input checked="" type="checkbox"/> ON	<input type="checkbox"/> OFF	▼	1920x1080@60HZ * ▼
Port13	<input checked="" type="checkbox"/> ON	<input type="checkbox"/> OFF	▼	1920x1080@60HZ * ▼
Port14	<input checked="" type="checkbox"/> ON	<input type="checkbox"/> OFF	▼	1920x1080@60HZ * ▼
Port15	<input checked="" type="checkbox"/> ON	<input type="checkbox"/> OFF	▼	1920x1080@60HZ * ▼
Port16	<input checked="" type="checkbox"/> ON	<input type="checkbox"/> OFF	▼	1920x1080@60HZ * ▼
Port17	<input checked="" type="checkbox"/> ON	<input type="checkbox"/> OFF	▼	1920x1080@60HZ * ▼
Port18	<input checked="" type="checkbox"/> ON	<input type="checkbox"/> OFF	▼	1920x1080@60HZ * ▼
Port19	<input checked="" type="checkbox"/> ON	<input type="checkbox"/> OFF	▼	1920x1080@60HZ * ▼

### Note:

- ◆ The *Transition*, *Period*, and *Scale Resolution* options are disabled when Seamless Switch™ is turned off. Seamless Switch™ cannot be turned off from the video wall editor.
- ◆ When Seamless Switch™ is enabled, video outputs will not display 3D, Deep Color, or interlace (i.e., 1080i) resolutions correctly. To use these features, make sure to first disable Seamless Switch™.

- ◆ **Seamless Switch:** Turning *Seamless Switch* on removes the video distortion and delay seen when an Input port is switched.
  - ◆ Use the drop-down menu to apply options to all ports, or the On/Off button to enable/disable Seamless Switching per port.
- ◆ **Transition:** Allows you to fade the video display when the Input port is changed. Use the period option to set the fade speed.

- ◆ Use the drop-down menu to apply options to all ports, or On/Off button to enable/disable Transition per port.
- ◆ **Period:** Sets the fade speed for the Transition option.
  - ◆ Use the drop-down menu to apply an option (*Slow*, *Normal*, or *Fast*) to all ports, or lower drop-down menus to apply options per port.
- ◆ **Scale Resolution:** Forces the port to scale the video displayed to the selected resolution.
  - ◆ Use the top drop-down menu to apply an option to all ports, or lower drop-down menus to apply options per port.
- ◆ Click **Test** to play current profile without saving.
- ◆ Click **Save & Apply** to save a profile and begin playing it.
- ◆ Click **Save** to save the profile.
- ◆ Click **Save as** to save the profile as a different profile number.
- ◆ Click **Cancel** to undo all unsaved changes.

## System Settings

Click the *Settings* link from the Profile List page for the system settings to open on the **General** page:

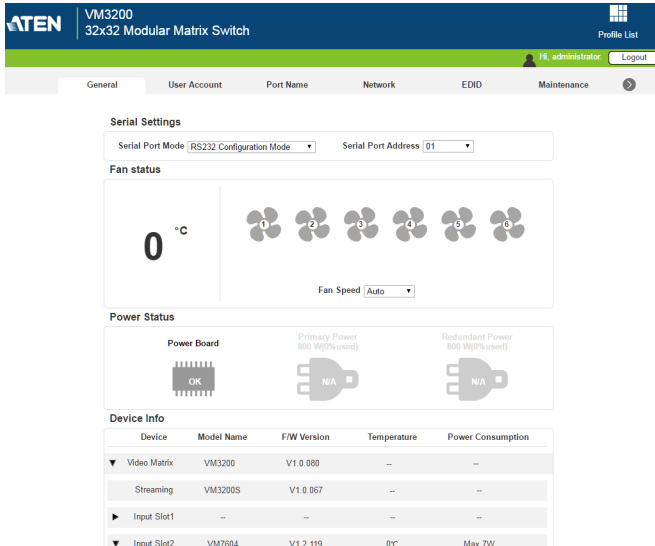

- ◆ The *General* page allows you to configure Serial Settings, Fan Status, Power Status, Device Info and Other settings.
- ◆ The *User Account* page allows you to add and edit user accounts.
- ◆ The *Port Name* page allows you to name each input and output port.
- ◆ The *Network* page allows configuration of the network settings.
- ◆ The *EDID* page is used to set the EDID modes.
- ◆ The *Maintenance* page is for upgrading the device's firmware.
- ◆ The *IR/RS232 Channel* page allows you to set the IR and RS232 channel settings\*.
- ◆ The HDCP page allows you to set the HDCP configuration.
- ◆ The *OSD/CEC* page allows users to control port OSD and CEC settings. Use > to access the OSD/CEC page.
- ◆ Click **Profile List** to return to the Main page.

**Note:** The *IR/RS232 Channel* page is only available when VM7514/VM8514 I/O boards are installed to the VM3200.

## General

The *General* page has three sections: Serial Settings, Fan Status, Power Status, Device Info and Other.

### Serial Settings

Serial Port Mode  Serial Port Address

### Fan status

0 °C



Fan Speed

### Power Status

Power Board



Primary Power  
800 W(0%used)

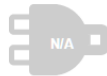

Redundant Power  
800 W(0%used)

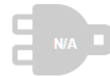

## Serial Settings

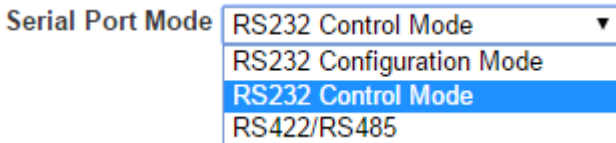

- ◆ Use the *Serial Port Mode* drop-down menu to select a signal for the serial port: **RS232 Configuration Mode**, **RS232 Control Mode**, and **RS422/RS485**.
- ◆ **RS232 Configuration Mode** allows the user to configure VM3200's system.
- ◆ **RS232 Control Mode** allows the user to control the (remote) devices that are connected to VM3200 through its RS232 channels. Select the **RS232 Control Mode** and click save. On the *RS232 Channel tab*, you'll be able to choose from two modes: Broadcast (1-All) or Manual mode.

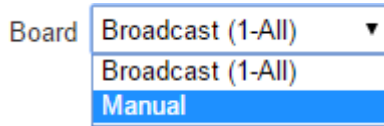

Select Broadcast (1-All) to enable control of all the connected devices simultaneously, or Manual mode to control the connected devices one to one or one to multiple.

- ◆ If you are using **RS422/RS485**, select the *Serial Port Address*. Options are: 1-16.

### Fan Status

This section displays the internal temperature and status of the cooling fans.

- ◆ Fans rotate to indicate they are working
- ◆ Use the drop-down menu to select the **Fan Speed**.
- ◆ If the fans have stopped working or are switched off, the icon will appear as follows: . This may mean the fan module needs to be replaced or reset.

### Power Status

This section displays the status of the Primary and Redundant Power units.

### Device Info

This section lists information about input and output boards connected to the VM3200, such as Model Name, Firmware Version, Temperature and Power Consumption.

## System Time

Device Info				
Device	Model Name	F/W Version	Temperature	Power Consumption
▼ Video Matrix	VM3200	V1.0.080	--	--
▶ Streaming	VM3200S	V1.0.067	--	--
▶ Input Slot1	--	--	--	--
▼ Input Slot2	VM7604	V1.2.119	0°C	Max. 7W
▶ Input Slot3	--	--	--	--
▶ Input Slot4	--	--	--	--
▶ Input Slot5	--	--	--	--
▶ Input Slot6	--	--	--	--
▶ Input Slot7	--	--	--	--
▶ Input Slot8	--	--	--	--
▶ Output Slot1	--	--	--	--
▶ Output Slot2	--	--	--	--
▶ Output Slot3	--	--	--	--
▶ Output Slot4	--	--	--	--
▶ Output Slot5	--	--	--	--

## System Time

Date(Y/M/D): 2017 / 02 / 23

Time: 10 : 58 [Edit](#)

**System Time** allows the time to be set in accordance with the needs of the profile scheduling. Click on *Edit*; a new window will appear.



Time Setting

**Synchronize with Computer Time**  
 Date: 2017/02/23  
 Time: 11:00:21

**Synchronize with Server Time**  
 NTP Server: AU | ntp1.cs.mu.OZ ▾  
 Manual IP:   
 Alternative Time Server  
 NTP Server: AU | ntp1.cs.mu.OZ ▾  
 Manual IP:   
 Adjustment Frequency: 1 Days  
 Time Zone: (GMT+08:00) Taipei ▾  
 Enable Daylight Saving Time(DST)

**Set Manually**  
 Date: 2017 ▾ / 02 ▾ / 23 ▾  
 Time: 11 ▾ : 00 ▾ : 18 ▾

The **Time Setting** edit window has different configuration options. The options are:

- ◆ **Synchronize with Computer Time** - Select to duplicate the time the computer.
- ◆ **Synchronize with Server Time** - Select to duplicate the time of a server. You can choose the server from the drop down menu, or manually enter a server's IP address.
- ◆ **Set Manually** - Use this option to manually configure the time settings.

## Other

**Other**

Language  ▾ Baud Rate  ▾

- ◆ Use the **Language** drop-down menu to select a preferred user interface language. Options include: English, French, German, Italian, Japanese, Korean, Portuguese, Russian, Spanish, Simplified Chinese and Traditional Chinese.
- ◆ Use the **Baud Rate** drop-down menu to select a serial port setting. Options include: 9600, 19200, 38400 and 115200.



## User Account

The *User Account* page lets you add, edit, or delete user accounts and change the password for accessing the VM3200's GUI.

**Note:** This is an Administrator only function.

User Name	Level	Description
administrator	Administrator	Default_user
bill00	Administrator	
brett	Administrator	
sherlock	Administrator	

- ◆ **+ Add account** – Click to add a new user account. The VM3200 supports up to 32 users (see *Add Account*, page 93) and allows up to 16 concurrent logins.
- ◆ **Edit** – Click to change a user's information. This option allows an Administrator to edit accounts.

User Name	Level	Description
<a href="#">Edit</a> administrator	Administrator	Default_user
<a href="#">Edit</a> bill00	Administrator	
<a href="#">Edit</a> brett	Administrator	
<a href="#">Edit</a> sherlock	Administrator	

- ◆ **Edit** – Click to edit a user account (see see page 93 for details for more details).
- ◆ **Delete** – Removes the user account .
- ◆ The default username and password are: administrator/password.

## Add Account

Use the **Add Account** / **Edit** buttons to create a user account, set the user's password, add a description, and set the user's permission level (see *Permission Level*, page 94) when accessing the VM3200's GUI.

**Add account**

Username

Password

Confirm Password

Please enter 5-16 characters without \*+@=#[];:~<?>() space &

Description

Permission Level

Administrator Open/Save Profiles, Manage users

Advanced User Open/Save Profiles

Basic User Open Profiles

- ◆ Fill in a username or edit an existing one.
- ◆ Enter a password and re-type the password to confirm.

---

**Note:** Usernames and passwords accept multi-lingual characters, and must be 5–16 alphanumeric characters (excluding ;=[]+=?\|). Passwords are case sensitive. Usernames only support lower case letters.

---

- ◆ Add or edit the description for the user.
- ◆ Select the permission level that you want to grant the user (see page 94 for details).
- ◆ Click **Create User** to save the data.
- ◆ Click **Cancel** to discard the changes and exit.
- ◆ If a user is logged into the VM3200's GUI, their user settings cannot be edited, and the fields in this screen are grayed out.

## Permission Level

At the bottom of the New/Edit User page is the permission section, which is used to set a user's permission level.

The screenshot shows a web form titled "Add account" with a green header. The form contains several input fields: "Username", "Password", "Confirm Password", and "Description". Below the "Description" field is the "Permission Level" section, which is highlighted with a red rectangular box. This section contains three radio button options: "Administrator Open/Save Profiles, Manage users", "Advanced User Open/Save Profiles", and "Basic User Open Profiles". The "Basic User" option is selected. At the bottom of the form are two buttons: "Create User" and "Cancel".

The three available permission levels are as follows:

- ◆ **Administrator** – this level provides full access and control of the VM3200, in addition to full User Management privileges.
- ◆ **Advanced User** – this level provides full access and control with no User Management privileges.
- ◆ **Basic User** – this level only provides basic functions (play connections and open connection profiles).

## Port Name

The *Port Name* page lets users name the Input and Output ports for easy identification.

Please enter characters without using \*+/@=[:;~<=>?()\&

Output Port		
Port1	01	<input type="text" value="Port_Out_1"/>
Port2	02	<input type="text" value="Port_Out_2"/>
Port3	03	<input type="text" value="Port_Out_3"/>
Port4	04	<input type="text" value="Port_Out_4"/>
Port5	05	<input type="text" value="Port_Out_5"/>
Port6	06	<input type="text" value="Port_Out_6"/>
Port7	07	<input type="text" value="Port_Out_7"/>
Port8	08	<input type="text" value="Port_Out_8"/>
Port9	09	<input type="text" value="Port_Out_9"/>
Port10	10	<input type="text" value="Port_Out_10"/>
Port11	11	<input type="text" value="Port_Out_11"/>
Port12	12	<input type="text" value="Port_Out_12"/>

Input Port		
Port1	01	<input type="text" value="Port_In_1"/>
Port2	02	<input type="text" value="Port_In_2"/>
Port3	03	<input type="text" value="Port_In_3"/>
Port4	04	<input type="text" value="Port_In_4"/>
Port5	05	<input type="text" value="Port_In_5"/>
Port6	06	<input type="text" value="Port_In_6"/>
Port7	07	<input type="text" value="Port_In_7"/>
Port8	08	<input type="text" value="Port_In_8"/>
Port9	09	<input type="text" value="Port_In_9"/>
Port10	10	<input type="text" value="Port_In_10"/>
Port11	11	<input type="text" value="Port_In_11"/>
Port12	12	<input type="text" value="Port_In_12"/>

- ◆ To name an Input/Output port, enter a descriptive name of up to 16 characters (including 0-9, a-z, A-Z, \_, -) in the corresponding field.
- ◆ To change an Input/Output port's name, enter another value and click **Save**.
- ◆ Click **Reset** to clear all stored names.

---

**Note:** The Input and Output port names can be the same.

---

## Network

The *Network* page lets you configure the VM3200's IP settings for connecting to it via the web GUI, and enable/disable Telnet.

DHCP	<input checked="" type="radio"/> Enable <input type="radio"/> Disable
IP Address	<input type="text" value="10.3.52.135"/>
Subnet Mask	<input type="text" value="255.255.254.0"/>
Default Gateway	<input type="text" value="10.3.53.254"/>
<input type="checkbox"/> Use the following DNS server	
Preferred DNS	<input type="text" value="10.0.1.7"/>
Alternative DNS	<input type="text" value="10.0.1.6"/>
Website Timeout	<input type="text" value="30 min"/>
MAC Address	00:10:74:B9:80:06
Telnet	<input checked="" type="radio"/> Enable <input type="radio"/> Disable

**Enable** DHCP to allow the DHCP server to assign an IP address to the VM3200. Select **Disable** to enter your own static IP address settings for the device.

Click **Reset** to use the following default values:

- ◆ IP Address – **192.168.0.60**
- ◆ Subnet Mask – **255.255.255.0**
- ◆ Default Gateway – **192.168.0.1**
- ◆ Website Timeout\* – N/A, 5, 10, 30, 60 minutes
- ◆ Telnet Configuration enabled

Enter the values, then click **Save**. Changes may take a few seconds and after refreshing the page automatically redirects you to the IP address specified.

---

\* This option controls how long an inactive web connection stays logged into the VM3200. Any changes will take effect immediately. The default setting is 5 minutes.

---

## EDID

The *EDID* page lets users view and select an EDID Mode so that the VM3200 can use the best resolution for its display(s).

EDID Mode	EDID & CEA Description	Retrieve EDID	Save
<input type="radio"/> ATEN Default <input type="radio"/> Port1 Mode <input type="radio"/> Remix <input checked="" type="radio"/> Customized <input type="button" value="Apply"/> Port EDID Status <input checked="" type="radio"/> Port 1 Customized <input type="radio"/> Port 2 Customized <input type="radio"/> Port 3 Customized <input type="radio"/> Port 4 Customized <input type="radio"/> Port 5 Customized <input type="radio"/> Port 6 Customized <input type="radio"/> Port 7 Customized <input type="radio"/> Port 8 Customized <input type="radio"/> Port 9 Customized <input type="radio"/> Port 10 Customized	<b>EDID</b> 1. Vendor/Product Identification 2. EDID Structure/Revision 3. Basic Display/Feature 4. Color Characteristics 5. Established Timings 6. Standard Timings 7. Detail Timing/Display Description 1 8. Detail Timing/Display Description 2 9. Monitor Description 10. Monitor Description  <b>CEA</b> 1. Display Support 2. Video Data 3. Audio Data 4. Speaker Allocation 5. Vendor Specific Data 8. Detail Timing/Display Description 3 9. Detail Timing/Display Description 4 10. Detail Timing/Display Description 5	Model ID: 0x0000 Manufacturer ID: LCD Serial Number: 0x00000001 Manufacture Date: 2011 Week 0 Week of Manufacture: 0 Year of Manufacture: 2011	

**Note:** The EDID Mode can also be selected via the Front Panel pushbuttons – see *Operation Mode*, page 46.

Extended Display Identification Data (EDID) is a data format that contains a display's basic information and is used to communicate with the video source/system.

## EDID Mode

In the left panel of the page, users can select a pre-configured EDID Mode using the **EDID Mode** radio buttons.

EDID Mode	EDID & CEA Description				
<input checked="" type="radio"/> ATEN Default <input type="radio"/> Port1 Mode <input type="radio"/> Remix <input type="radio"/> Customized <input type="button" value="Apply"/>	<table border="1"> <tr> <td> <b>EDID</b>                      1. Vendor/Product Identification                      2. EDID Structure/Revision                      3. Basic Display/Feature                      4. Color Characteristics                      5. Established Timings                      6. Standard Timings                      7. Detail Timing/Display Description 1                      8. Detail Timing/Display Description 2                      9. Monitor Description                      10. Monitor Description                 </td> <td>                     Model ID: 0x0000                      Manufacturer ID: LCD                      Serial Number: 0x00000001                      Manufacture Date: 2011 Week 0                      Week of Manufacture: 0                      Year of Manufacture: 2011                 </td> </tr> <tr> <td> <b>CEA</b>                      1. Display Support                      2. Video Data                      3. Audio Data                      4. Speaker Allocation                      5. Vendor Specific Data                      8. Detail Timing/Display Description 3                      9. Detail Timing/Display Description 4                      10. Detail Timing/Display Description 5                 </td> <td></td> </tr> </table>	<b>EDID</b> 1. Vendor/Product Identification 2. EDID Structure/Revision 3. Basic Display/Feature 4. Color Characteristics 5. Established Timings 6. Standard Timings 7. Detail Timing/Display Description 1 8. Detail Timing/Display Description 2 9. Monitor Description 10. Monitor Description	Model ID: 0x0000 Manufacturer ID: LCD Serial Number: 0x00000001 Manufacture Date: 2011 Week 0 Week of Manufacture: 0 Year of Manufacture: 2011	<b>CEA</b> 1. Display Support 2. Video Data 3. Audio Data 4. Speaker Allocation 5. Vendor Specific Data 8. Detail Timing/Display Description 3 9. Detail Timing/Display Description 4 10. Detail Timing/Display Description 5	
<b>EDID</b> 1. Vendor/Product Identification 2. EDID Structure/Revision 3. Basic Display/Feature 4. Color Characteristics 5. Established Timings 6. Standard Timings 7. Detail Timing/Display Description 1 8. Detail Timing/Display Description 2 9. Monitor Description 10. Monitor Description	Model ID: 0x0000 Manufacturer ID: LCD Serial Number: 0x00000001 Manufacture Date: 2011 Week 0 Week of Manufacture: 0 Year of Manufacture: 2011				
<b>CEA</b> 1. Display Support 2. Video Data 3. Audio Data 4. Speaker Allocation 5. Vendor Specific Data 8. Detail Timing/Display Description 3 9. Detail Timing/Display Description 4 10. Detail Timing/Display Description 5					
Port EDID Status Port 1 Customized Port 2 Customized Port 3 Customized Port 4 Customized Port 5 Customized Port 6 Customized Port 7 Customized Port 8 Customized Port 9 Customized Port 10 Customized					

Select the EDID Mode to use and click **Apply**. The VM3200 uses the settings configured for that EDID mode.

Options are:

- ◆ **ATEN Default:** All ports' EDID are the same as the hardware default EDID.
- ◆ **Port 1 Mode:** All ports' EDID are the same as Port1's EDID.
- ◆ **Remix:** All ports' EDID use the best display resolution.
- ◆ **Customized:** See *Customized Mode*, page 100.



## EDID & CEA Description

The right panel of the screen lets users view the configuration of the *EDID* and *CEA* Modes selected:

**EDID Mode**

ATEN Default  
 Port1 Mode  
 Remix  
 Customized

Apply

Port EDID Status

Port 1 Customized

Port 2 Customized

Port 3 Customized

Port 4 Customized

Port 5 Customized

Port 6 Customized

Port 7 Customized

Port 8 Customized

Port 9 Customized

Port 10 Customized

**EDID & CEA Description**

**EDID**

1. Vendor/Product Identification
2. EDID Structure/Revision
3. Basic Display/Feature
4. Color Characteristics
5. Established Timings
6. Standard Timings
7. Detail Timing/Display Description 1
8. Detail Timing/Display Description 2
9. Monitor Description
10. Monitor Description

**CEA**

1. Display Support
2. Video Data
3. Audio Data
4. Speaker Allocation
5. Vendor Specific Data
8. Detail Timing/Display Description 3
9. Detail Timing/Display Description 4
10. Detail Timing/Display Description 5

Model ID: 0x0000  
 Manufacturer ID: LCD  
 Serial Number: 0x00000001  
 Manufacture Date: 2011 Week 0  
 Week of Manufacture: 0  
 Year of Manufacture: 2011

- ◆ From the left column, click the option that you want to view and/or edit. There are two categories: **EDID** (Extended Display Identification Data) and **CEA** (Consumer Electronics Association).
- ◆ When you highlight the menu items on the left column, the right column displays the current settings for the corresponding EDID configuration. Some of the screens are read-only.
- ◆ See *EDID*, page 97 for more information on these two columns.

## Customized Mode

Use the *Customized* Mode to automatically retrieve and save the EDID settings of a connected monitor/display device to an input source port.

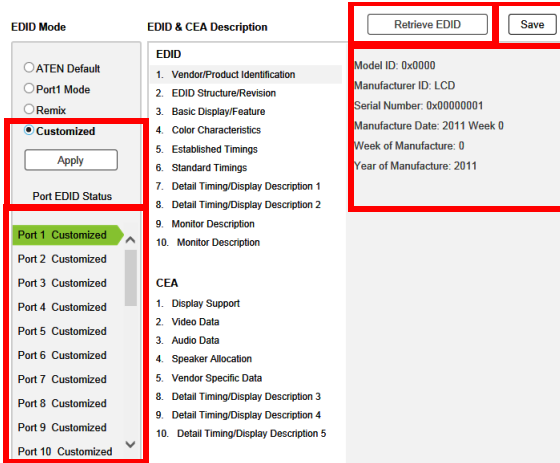

- ◆ In the left-most panel of the page, select **Customized** from the *EDID Mode* section and click **Apply**.
- ◆ **Port EDID Status**: Select which input source port you want to store the EDID configuration (01–32).
- ◆ **Retrieve EDID**: Click and a pop-up window appears to retrieve the EDID settings of a stored EDID configuration: *Customized EDID 01-32*, *Display Port* or *ATEN Default*. Select the port to retrieve:

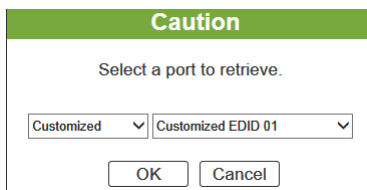

- ◆ The right panel displays a summary of the acquired EDID settings that you can edit. Click **Save** and select the configuration for the **Current Port** or **All Ports** for the duration of the session.

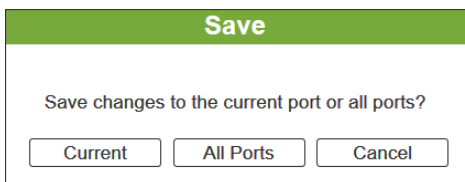

## Customized EDID Parameters

The EDID structure is comprised of 128 bytes in total – each heading shown in the left column corresponds to a specific number of bytes.

The pages for the pre-configured EDID Modes (Port 1, Default and Remix) cannot be edited. The pages for the Customized EDID, which can be edited, are discussed in the proceeding sections:

## Established Timings

This page lists video resolutions/timings that display devices can support.

The screenshot shows the EDID configuration interface. On the left, under 'EDID Mode', 'Customized' is selected. The main area is titled 'EDID & CEA Description'. The 'EDID' section lists 10 items, with '5. Established Timings' highlighted. The 'CEA' section lists 5 items. A list of video resolutions is shown on the right, with checkboxes for each. A red box highlights the 'Established Timings' section and the list of resolutions. The 'Clear' and 'Select All' buttons are visible at the bottom of the list.

Resolution/Timing	Selected
<input type="checkbox"/> 720x400 @ 70Hz	
<input type="checkbox"/> 720x400 @ 88Hz	
<input checked="" type="checkbox"/> 640x480 @ 60Hz	✓
<input type="checkbox"/> 640x480 @ 67Hz	
<input checked="" type="checkbox"/> 640x480 @ 72Hz	✓
<input checked="" type="checkbox"/> 640x480 @ 75Hz	✓
<input checked="" type="checkbox"/> 800x600 @ 56Hz	✓
<input checked="" type="checkbox"/> 800x600 @ 60Hz	✓
<input checked="" type="checkbox"/> 800x600 @ 72Hz	✓
<input checked="" type="checkbox"/> 800x600 @ 75Hz	✓
<input type="checkbox"/> 832x624 @ 75Hz (Apple Macintosh II)	
<input type="checkbox"/> 1024x768 @ 87Hz, interlaced(1024*768i)	
<input checked="" type="checkbox"/> 1024x768 @ 60Hz	✓
<input checked="" type="checkbox"/> 1024x768 @ 70Hz	✓
<input checked="" type="checkbox"/> 1024x768 @ 75Hz	✓
<input checked="" type="checkbox"/> 1280x1024 @ 75Hz	✓
<input type="checkbox"/> 1152x870 @ 75Hz(Apple Macintosh II)	

- ◆ Select the resolution(s) you want to use for the attached monitor/display device.
- ◆ Click **Clear All** to deselect all the items.
- ◆ Click **Select All** to check all the items.
- ◆ Click **Save** to apply the changes.

## Standard Timings

This page shows eight resolutions/timings that display devices can support in addition to those listed in the Established Timings page.

EDID Mode:  ATEN Default,  Port1 Mode,  Remix,  Customized

Port EDID Status: Port 1 Customized, Port 2 Customized, Port 3 Customized, Port 4 Customized, Port 5 Customized, Port 6 Customized, Port 7 Customized, Port 8 Customized, Port 9 Customized, Port 10 Customized

EDID & CEA Description

EDID

H Active Pixel	V Active Pixel	R Refresh Rate	Aspect Ratio
H 256	V 160	R 61	16:10
H 256	V 160	R 61	16:10
H 256	V 160	R 61	16:10
H 256	V 160	R 61	16:10
H 256	V 160	R 61	16:10
H 256	V 160	R 61	16:10
H 256	V 160	R 61	16:10
H 256	V 160	R 61	16:10

CEA

1. Display Support
2. Video Data
3. Audio Data
4. Speaker Allocation
5. Vendor Specific Data
8. Detail Timing/Display Description 3
9. Detail Timing/Display Description 4
10. Detail Timing/Display Description 5

- ◆ Select the *H Active Pixel* from the drop-down menu.
- ◆ Select the *Aspect Ratio* from the drop-down menu.
- ◆ Click **Save** to apply the changes.

## Detail Timing / Display Description

This screen gives more video resolution options, and provides resolution/timing details.

EDID Mode:  ATEN Default,  Port1 Mode,  Remix,  Customized

Port EDID Status: Port 1 Customized, Port 2 Customized, Port 3 Customized, Port 4 Customized, Port 5 Customized, Port 6 Customized, Port 7 Customized, Port 8 Customized, Port 9 Customized, Port 10 Customized

EDID & CEA Description

EDID

Resolution: [Dropdown Menu]

Pixel Clock(MHz): 74.25

Stereo Display  
 Interfaced: Non-interfaced  
 Stereo Mode: none  
 Sync type: Digital Separate  
 Positive Vsync Polarity: yes  
 Positive Hsync Polarity: yes

Resolution Detail

	Horizontal	Vertical
Image Size :	mm	mm
Active Pix :	pixel	lines
Blanking Time:	pixel	lines
Sync Offset:	pixel	lines
Sync Width:	pixel	lines
Border:	pixel	lines

CEA

1. Display Support
2. Video Data
3. Audio Data
4. Speaker Allocation
5. Vendor Specific Data
8. Detail Timing/Display Description 3
9. Detail Timing/Display Description 4
10. Detail Timing/Display Description 5

In the drop down menu, choose a resolution with values that fit the attached monitor/display device and click Save.

## Monitor Description

This screen lets you specify the viewing specifications, namely horizontal and vertical scan ranges and pixel clock rate, of your monitor/display device.

**EDID Mode**

ATEN Default

Port1 Mode

Remix

**Customized**

Port EDID Status

- Port 1 Customized
- Port 2 Customized
- Port 3 Customized
- Port 4 Customized
- Port 5 Customized
- Port 6 Customized
- Port 7 Customized
- Port 8 Customized
- Port 9 Customized
- Port 10 Customized

**EDID & CEA Description**

	Minutes	Max
Horizontal Scan Range:	15	~ 46
Vertical Scan Range:	59	~ 61
Pixel Clock Rate: (MHz)	80	(10~2550)

**EDID**

1. Vendor/Product Identification
2. EDID Structure/Revision
3. Basic Display/Feature
4. Color Characteristics
5. Established Timings
6. Standard Timings
7. Detail Timing/Display Description 1
8. Detail Timing/Display Description 2
9. Monitor Description
10. Monitor Description

**CEA**

1. Display Support
2. Video Data
3. Audio Data
4. Speaker Allocation
5. Vendor Specific Data
8. Detail Timing/Display Description 3
9. Detail Timing/Display Description 4
10. Detail Timing/Display Description 5

Enter the values that correspond to your device and click **Save** to apply the changes.

## CEA Settings

CEA is an extension data of the EDID structure, which further extends the standard definitions of EDID to support advanced features of monitors/display devices.

### Display Support

This screen describes the display's basic digital components.

**EDID Mode**

ATEN Default

Port1 Mode

Remix

**Customized**

Apply

Port EDID Status

Port 1 Customized

Port 2 Customized

Port 3 Customized

Port 4 Customized

Port 5 Customized

Port 6 Customized

Port 7 Customized

Port 8 Customized

Port 9 Customized

Port 10 Customized

**EDID & CEA Description**

Retrieve EDID
Save

<b>EDID</b>	Revision: 0x03
1. Vendor/Product Identification	Underscan: no
2. EDID Structure/Revision	Basic Audio: yes
3. Basic Display/Feature	YCbCr: <input checked="" type="checkbox"/> YCbCr444
4. Color Characteristics	<input checked="" type="checkbox"/> YCbCr422
5. Established Timings	
6. Standard Timings	
7. Detail Timing/Display Description 1	
8. Detail Timing/Display Description 2	
9. Monitor Description	
10. Monitor Description	
<b>CEA</b>	
1. Display Support	
2. Video Data	
3. Audio Data	
4. Speaker Allocation	
5. Vendor Specific Data	
8. Detail Timing/Display Description 3	
9. Detail Timing/Display Description 4	
10. Detail Timing/Display Description 5	

Select the YCbCr mode applicable to your display and click **Save**.

## Video Data

This screen lists additional video resolution/timing displays that may be supported by other devices, other than PC monitors (for example, 1080i).

The screenshot shows a web-based configuration interface for EDID (Extended Display Identification Data) settings. The interface is divided into several sections:

- EDID Mode:** Includes radio buttons for "ATEN Default", "Port1 Mode", "Remix", and "Customized" (which is selected). There is an "Apply" button and a "Port EDID Status" section with a list of ports (Port 1 to Port 10) all set to "Customized".
- EDID & CEA Description:** A list of 10 items for EDID and 10 items for CEA. Item 2, "Video Data", is highlighted.
- Resolution Selection:** A dropdown menu labeled "Native:" is set to "1280 x 720p @ 59.94/60Hz 16:9". Below it, a list of resolutions is shown with checkboxes:
 

Resolution/Timing	Selected
640 x 480p @ 59.94/60Hz 4:3	<input checked="" type="checkbox"/>
720 x 480p @ 59.94/60Hz 4:3	<input checked="" type="checkbox"/>
720 x 480p @ 59.94/60Hz 16:9	<input checked="" type="checkbox"/>
1280 x 720p @ 59.94/60Hz 16:9	<input checked="" type="checkbox"/>
1920 x 1080i @ 59.94/60Hz 16:9	<input checked="" type="checkbox"/>
720(1440) x 480i @ 59.94/60Hz 4:3	<input type="checkbox"/>
720(1440) x 480i @ 59.94/60Hz 16:9	<input type="checkbox"/>
720(1440) x 240p @ 59.94/60Hz 4:3	<input type="checkbox"/>
720(1440) x 240p @ 59.94/60Hz 16:9	<input type="checkbox"/>
2880 x 480i @ 59.94/60Hz 4:3	<input type="checkbox"/>
2880 x 480i @ 59.94/60Hz 16:9	<input type="checkbox"/>
- Buttons:** "Retrieve EDID" and "Save" buttons are at the top right. A "Clear" button is located below the resolution list.

- ◆ Select the native resolution of the attached display device.
- ◆ Select the resolutions that work with the attached monitor/display device.
- ◆ Click **Clear All** to deselect all the items.
- ◆ Click **Save** to apply the changes.

## Audio Data

This screen lets you select advanced audio configurations for your device.

The screenshot shows the 'Audio Data' configuration interface. On the left, under 'EDID Mode', the 'Customized' radio button is selected. Below it, a list of ports from Port 1 to Port 10 is shown, with 'Port 1 Customized' highlighted. On the right, under 'EDID & CEA Description', the 'Audio Data' section is expanded. A red box highlights the 'Audio Format' dropdown menu, which is currently set to 'Linear PCM 2-channel'. Other audio format options (2-6) are visible but not selected. 'Retrieve EDID' and 'Save' buttons are at the top right.

Use the drop down menu to select the **Audio Format** (1~6) applicable to your audio output device, and click **Save** to apply the changes.

## Detail Timing / Display Description

This screen gives more video resolution options, and provides resolution/timing details (in addition to those specified in the EDID structure).

The screenshot shows the 'Detail Timing / Display Description' configuration interface. On the left, under 'EDID Mode', the 'Customized' radio button is selected. On the right, under 'EDID & CEA Description', the 'Detail Timing/Display Description 3' section is expanded. A red box highlights the 'Resolution' dropdown menu, which is currently empty. Below it, the 'Pixel Clock(MHz)' field is visible. Further down, there are sections for 'Interlaced', 'Stereo Mode', and 'Resolution Detail'. The 'Resolution Detail' section contains a table with columns for 'Image Size', 'Active PXL', 'Blanking Time', 'Sync Offset', 'Sync Width', and 'Border', with sub-columns for 'Horizontal' and 'Vertical' values.

Image Size	Horizontal	Vertical
min	min	min
Active PXL	pixel	lines
Blanking Time	pixel	lines
Sync Offset	pixel	lines
Sync Width	pixel	lines
Border	pixel	lines

In the **Resolution** drop down menu, choose a resolution with values that fit the attached monitor/display device and click **Save**.



## Maintenance

### Upgrading the VM3200

The *Maintenance* page lets users upgrade the VM3200's firmware and back up or restore system settings. This is an Administrator only function.

#### Firmware upgrade

#### Backup / Restore

\*User accounts cannot be backed up or restored.

To upgrade the VM3200's firmware, do the following:

1. Use the **Browse** button to locate the firmware upgrade file. Make sure you have the correct file saved on your PC.
2. Click **Upgrade** to begin the upgrade procedure.

---

**Note:** After updating the firmware, it's recommended that you clear your web browser's cache and then close and reopen the web browser. This will ensure the GUI refreshes and functions properly.

---

To back up the VM3200's system settings, do the following:

1. Click **Backup**. A configuration file will then begin downloading.

To restore the VM3200's system settings, do the following:

1. Use the **Browse** button to locate the configuration file. Make sure you have the correct file saved on your PC.
2. Click **Restore** to begin the restoration procedure.

---

**Note:** User accounts cannot be backed up or restored.

---

## **Upgrading the VE805R**

To upgrade the VE805R from a computer, do the following:

1. Download the firmware upgrade package from the ATEN website.
2. Connect a computer to the VE805R's RS-232 port.
3. Power on the VE805R and turn its Firmware Upgrade switch to ON.
4. Reset the VE805R's power to enter firmware upgrade mode. The HDMI Out LED blinks orange every second to indicate the device is in F/W upgrade mode.
5. At this point you can run the firmware upgrade package from the computer connected to the VE805R.

## IR/RS232 Channel

The *RS232 Channel* page is available for VM7514/VM8514 boards only. The options allow you to set ports to use **RS232** which will direct the board to use the local RS232 port signals, or **HDBaseT RS232** which will direct the board to use the HDBaseT port for the RS232 signals for control.

Use **Loopback** for the RS232 signals to be sent back to local source or local display device connected to the same port on the same I/O board. This allows you to use the RS232 connection to control devices locally. Loopback prevents the RS232 signals from being sent across the connection to another I/O board. The Loopback setting is good when you use a VM8514 board to extend displays but use a different board type (not VM7514) for input devices and want to use the RS232 signals for local control.

**RS232 Channel**

**In-Board**

Port Apply to All

Port 1	<span style="border: 1px solid gray; padding: 2px;">Local RS232</span>
Port 2	<span style="border: 1px solid gray; padding: 2px;">Local RS232</span>
Port 3	<span style="border: 1px solid gray; padding: 2px;">Local RS232</span>
Port 4	<span style="border: 1px solid gray; padding: 2px;">Local RS232</span>
Port 5	<span style="border: 1px solid gray; padding: 2px;">Local RS232</span>
Port 6	<span style="border: 1px solid gray; padding: 2px;">Local RS232</span>
Port 7	<span style="border: 1px solid gray; padding: 2px;">Local RS232</span>
Port 8	<span style="border: 1px solid gray; padding: 2px;">Local RS232</span>
Port 9	<span style="border: 1px solid gray; padding: 2px;">Local RS232</span>
Port 10	<span style="border: 1px solid gray; padding: 2px;">Local RS232</span>
Port 11	<span style="border: 1px solid gray; padding: 2px;">Local RS232</span>
Port 12	<span style="border: 1px solid gray; padding: 2px;">Local RS232</span>
Port 13	<span style="border: 1px solid gray; padding: 2px;">Local RS232</span>
Port 14	<span style="border: 1px solid gray; padding: 2px;">Local RS232</span>
Port 15	<span style="border: 1px solid gray; padding: 2px;">Local RS232</span>
Port 16	<span style="border: 1px solid gray; padding: 2px;">Local RS232</span>

**Connection**

Follow Video Path

**Out-Board**

Port Apply to All

Port 1	<span style="border: 1px solid gray; padding: 2px;">Local RS232</span>
Port 2	<span style="border: 1px solid gray; padding: 2px;">Local RS232</span>
Port 3	<span style="border: 1px solid gray; padding: 2px;">Local RS232</span>
Port 4	<span style="border: 1px solid gray; padding: 2px;">Local RS232</span>
Port 5	<span style="border: 1px solid gray; padding: 2px;">Local RS232</span>
Port 6	<span style="border: 1px solid gray; padding: 2px;">Local RS232</span>
Port 7	<span style="border: 1px solid gray; padding: 2px;">Local RS232</span>
Port 8	<span style="border: 1px solid gray; padding: 2px;">Local RS232</span>
Port 9	<span style="border: 1px solid gray; padding: 2px;">Local RS232</span>
Port 10	<span style="border: 1px solid gray; padding: 2px;">Local RS232</span>
Port 11	<span style="border: 1px solid gray; padding: 2px;">Local RS232</span>
Port 12	<span style="border: 1px solid gray; padding: 2px;">Local RS232</span>
Port 13	<span style="border: 1px solid gray; padding: 2px;">Local RS232</span>
Port 14	<span style="border: 1px solid gray; padding: 2px;">Local RS232</span>
Port 15	<span style="border: 1px solid gray; padding: 2px;">Local RS232</span>
Port 16	<span style="border: 1px solid gray; padding: 2px;">Local RS232</span>

● RS232 Return Path    — Connection Path

The *IR Channel* page is available for VM7514/VM8514 boards only. The options allow you to set ports to use **Local IR** which will direct the board to use the local IR port signals, or **HDBaseT IR** which will direct the board to use the HDBaseT port for the IR and RS232 signals for control.

Use **Loopback** for the IR signals to be sent back to local source or local display device connected to the same port on the same I/O board. This allows you to use the IR connection to control devices locally. Loopback prevents the IR signals from being sent across the connection to another I/O board. The Loopback setting is good when you use a VM8514 board to extend displays but use a different board type (not VM7514) for input devices and want to use the IR signals for local control.

**IR Channel**

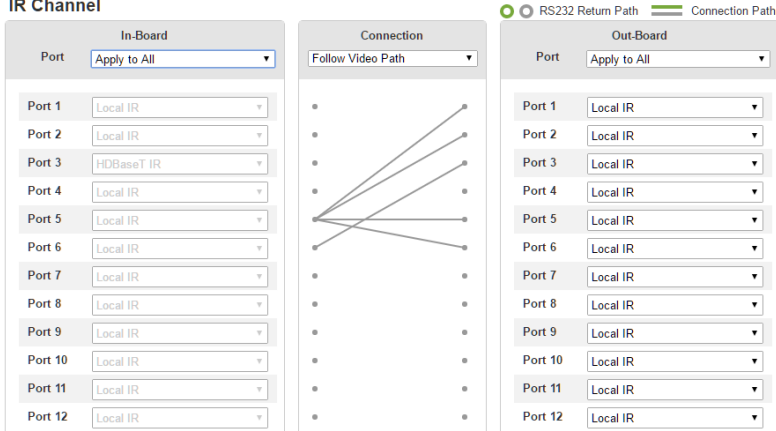

- ◆ **In-Board:** Set each input port to use the *Local IR/RS232*, *HDBaseT IR/RS232*, or *Loopback* setting for the IR/RS232 signals.
  - ◆ Use the drop-down menu to apply an option to all ports; or select *Local IR/RS232*, *HDBaseT IR/RS232* or *Loopback* for individual ports.
- ◆ **Connection:** Sets the connection path for the IR/RS232 signals.
  - ◆ Use the drop-down menu to select *Follow Video Path* to have the IR/RS232 signal use the same connection path as the profile settings.
  - ◆ Use the drop-down menu to select *Broadcast (1-All)* to broadcast the IR/RS232 signal from one port to all ports. Use the drop-down menu that appears to select the port that broadcasts the IR/RS232 signal.
- ◆ **Out-Board:** Set each output port to use the *Local IR/RS232*, *HDBaseT IR/RS232*, or *Loopback* setting for the IR/RS232 signals.
  - ◆ Use the drop-down menu to apply an option to all ports; or select *Local IR/RS232*, *HDBaseT IR/RS232* or *Loopback* for individual ports.

Click **Save** to save the settings. Click **Reset** to revert to the default settings.

---

**Note:** By default the RS232 Return Path will use the lowest port number available for a connection. This setting can not be changed.

---

## HDCP

The *HDCP* page lets users view and set HDCP key settings between input and output ports for digital copy protection and to ensure Seamless Switching between different devices. This is an Administrator and Advanced User only function.

The screenshot displays the 'HDCP Configuration' interface, which is divided into three main sections: 'Input', 'Connection', and 'Output'. A legend at the top right indicates that a green line represents the 'Connection Path'.

- Input Section:** Features a 'Port' dropdown menu set to 'Apply to All'. Below it are four rows, each representing a port (Port 1 to Port 4). Each row has a dropdown menu currently showing 'All Ports HDCP 1.4'.
- Connection Section:** A central diagram showing four dots on the left (representing input ports) and four dots on the right (representing output ports). Lines connect each input dot to its corresponding output dot, forming a fan shape.
- Output Section:** Features an 'Output' dropdown menu set to 'Apply to All'. Below it are four rows, each representing a port (Port 1 to Port 4). Each row contains a checkbox labeled 'Fix HDCP', which is currently unchecked.

### Connection

Here users can find a visual display of connection paths between inputs and outputs. When selecting an input, its path is displayed in green.

### Output

Here users can define whether or not HDCP settings are fixed, either by individual port or by applying one setting to all ports. By prearranging and fixing keys, this setting ensures that Seamless Switching is possible even when switching between HDCP and non-HDCP enabled devices.

## OSD/CEC

The OSD/CEC page lets users view and set OSD and CEC settings for all ports.

**OSD / CEC**

Port	OSD	CEC
	<input type="text" value="Apply to All"/>	<input type="text" value="Apply to All"/>
Port1	<input checked="" type="checkbox"/> ON	<input type="checkbox"/> OFF
Port2	<input checked="" type="checkbox"/> ON	<input type="checkbox"/> OFF
Port3	<input checked="" type="checkbox"/> ON	<input type="checkbox"/> OFF
Port4	<input checked="" type="checkbox"/> ON	<input type="checkbox"/> OFF

- ◆ **OSD:** Sets the default OSD option for the port. When OSD is on, real-time text updates appear on the display for 10 seconds when configuration and port changes are made to its output.
  - ◆ Use the drop-down menu to apply options to all ports, or ON/OFF button to enable/disable the OSD for each port.
- ◆ **CEC:** Consumer Electronics Control (CEC) allows interconnected HDMI devices to communicate and respond to one remote control.
  - ◆ Use the drop-down menu to apply options to all ports, or On/Off button to enable/disable CEC for a port.
- ◆ Click **Save** to save the settings or **Cancel** to exit without saving the settings.

---

## Telnet Operation

---

The VM3200 can be operated and configured via a remote terminal session using Telnet.

To log into the VM3200 by means of a Telnet session, do the following:

1. On your computer, open a terminal (command line) session.
2. At the prompt, key in the VM3200's IP address in the following way:  

```
telnet [IP address]:23
```
3. Press **Enter**. The login screen appears. At the login prompt, provide your Username and Password.

---

**Note:** If a user logs on using a Username that is already in session, the newest login takes effect and the previous session is replaced.

---

### Configuration Menu

Once a Telnet connection to the VM3200 is established, the device's text-based Configuration Menu comes up, with the following items:

#### **1. H – Call up the command list for help**

Command list:

IP – Set IP address

LO – Load connections from profile *nn*

PW – Change password

RI – Read what input is connected to *nn* output

RO – Read what output is connected to *nn* input

SB – Set the serial port baud rate

SS – Switch input to specified port

SV – Save the current connections into profile *nn*

TI – Set timeout

VR – Software version information

Ctrl-Q – Quit

## 2. IP – Set IP address

IP

Old IP address: 192.168.0.60

New IP address:

## 3. LO – Load connections from profile

LO 01

Load profile 01 OK.

## 4. PW – Change password

PW

Old password: \*\*\*\*\*

New password:

## 5. RI – Read what input is connected to *nn* output

RI 01

Input port 02 04 08 is connected to output port 01

## 6. RO – Read what output is connected to *nn* input

RO 01

Output port 02 is connected to input port 01

## 7. SB – Set serial port baud rate

SB 96

Serial port baud rate is set to 9600

## 8. SS – Switch input to specified output

SS 01, 03

Switch input 01 to output 03 (00: Local Port)

## 9. SV – Save the current connections into a profile

SV 01



Save the current connections into profile 01

## 10. TI – Set timeout

TI 30

Set 30 minute timeout

## 11. VR – Software version information

VR

Software version 1.0.

---

### Note:

- ♦ All RS-232 commands in this manual are also applicable in Telnet mode, see page 119 for details
  - ♦ For further information about these functions, refer to the corresponding sections earlier in this chapter.
-

This Page Intentionally Left Blank

# Chapter 5

## RS-232 Commands

### Serial Control Protocol Commands

---

The VM3200's built-in bi-directional RS-232 serial interface allows system control through a high-end controller or PC.

#### RS232 Pin Assignment

Pin	Description	Pin	Description
1	Not connected	6	Not connected
2	RXD	7	Not connected
3	TXD	8	Not connected
4	Not connected	9	Not connected
5	GND		

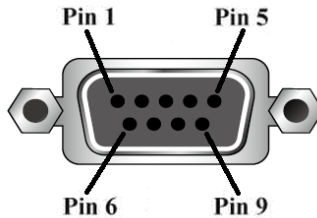

#### Configuring the Serial Port

The controller's serial port should be configured as follows:

Baud Rate	19200
Data Bits	8
Parity	None
Stop Bits	1
Flow Control	None

## **RS-422 / RS-485**

In the sections that follow the formulas that include an “address” command are for RS-422 and RS-485 serial port devices when the VM3200 is setup in cascade installation.

### **Verification**

After entering a command, a verification message appears at the end of the command line as follows:

- ♦ **Command OK** - indicates that the command is correct and successfully performed by the switch
- ♦ **Command incorrect** - indicates that the command has the wrong format and/or values.

## Switch Port Command

The formula for Switch commands is as follows:

**Switch Command + Input + Num1 + Output + Num2 + Address + Num3 + Stream + Control [Enter]**

1. For example, to switch input port 02 to output port 05, type the following:  
**sw i02 o05 [Enter]**
2. To switch output port 04 to the next port, input the following:  
**sw o04 + [Enter]**
3. To turn off video output on port 03, type the following:  
**sw o03 off [Enter]**
4. To turn off video output on port 03 on device 02, type the following:  
**sw o03 a02 off [Enter]**

The following tables show the possible values for the **Switch Port** command

Command	Description
sw	Switch command
Input	Description
i	Input port command
Num1	Description
xx	Input port xx: 01~16
*	All input ports
Output	Description
o	Output port command
Num2	Description
yy	Output port yy: 01~16
*	All output ports
Address	Description
a	Device address command (RS-422 and RS-485 only)

Num3	Description
zz	Device address zz: 01~16 (default is 01) (RS-422 and RS-485 only)
*	All devices

Stream	Description
video	Switch Video channel only
audio	Switch Stereo Audio channel only
all	Switch Video channel and Stereo Audio channel default select if been omitted

Control	Description
on	Turn on the display
off	Turn off the display
+	Next Port
-	Previous Port

---

**Note:** By default, input port 01 is tied to output port 01; input port 02 is tied to output port 02; and so on until port 08 (i.e., o01 i01, o02 i02... o16 i16)

---

The following table shows the available command list:

Command	Input	Input Port	Output	Output Port	Address	Device No.	Stream	Control	Enter	Description
sw	i	xx *	o	yy *	a	zz *	video audio all		[Enter]	Switch Input Port xx to Output Port yy on Address zz xx:01~16, * yy:01~16, * zz: 01~16, *
sw			o	yy *	a	zz *	video audio all	on off	[Enter]	Turn on Output Port yy Turn off Output Port yy on Address zz yy:01~16, * zz: 01~16, *
sw			o	yy *	a	zz *	video audio all	+ -	[Enter]	Switch Next Input to Output Port yy Switch Previous Input to Output Port yy yy:01~16, *

**Note:** 1. Each command string can be separated with a space.

2. The **Address** command is for RS-422/485 only. If the address parameter is missing from RS-422/485 commands, the default **a00** will be used. Skip the address for RS-232 commands.
3. The **Port Number** and **Address** command strings can be skipped, and the default value will be used.

## **Mute Command**

Mute allows you to enable or disable an output port(s) audio. The Mute command will turn on/off the HDMI audio and stereo audio. When the HDMI audio is off, the stereo's volume can be adjusted using the volume command.

The formula for the Mute command is as follows:

**Command + Output + Num1 + Address + Num2 + Control + [Enter]**

1. For example, to mute the audio on output port 03, type the following:  
**mute o03 on [Enter]**
2. To turn mute off on all output ports, type the following:  
**mute o\* off [Enter]**
3. To mute the audio for output port 09 on device 03, type the following:  
**mute o09 a03 on [Enter]**

The following tables show the possible values for the **Mute** command:

<b>Command</b>	<b>Description</b>
mute	Mute command

<b>Output</b>	<b>Description</b>
o	Output port command

<b>Num1</b>	<b>Description</b>
xx	Output port number xx: 01~16 (default is 01)
*	All output ports

<b>Address</b>	<b>Description</b>
a	Device address command (RS-422 and RS-485 only)

<b>Num2</b>	<b>Description</b>
zz	Device address zz: 01~16 (default is 01) (RS-422 and RS-485 only)
*	All devices

<b>Control</b>	<b>Description</b>
on	Mute on; audio on output port is disabled



Control	Description
off	Mute off; audio on output port is enabled (default)

- Note:**
1. Each command string can be separated with a space.
  2. The **Address** command is for RS-422/485 only. If the address parameter is missing from RS-422/485 commands, the default **a00** will be used. Skip the address for RS-232 commands.
  3. Skip the **Output** command to mute or enable the audio of all output ports.

The following table shows the available command list:

Command	Output	Num1	Address	Num2	Control	Enter	Description
mute	o	xx *	a	zz *	on	[Enter]	Mute audio for output port xx, on device zz xx:01~16, * zz: 01~16,*
mute	o	xx *	a	zz *	off	[Enter]	Turn mute off for output port xx, on device zz xx:01~16, * zz: 01~16,*

## Volume Command

The volume command allows adjust the stereo volume for an output port.

The formula for the Volume command is as follows:

**Command + Output + Num1 + Address + Num2 + Volume + Control + [Enter]**

1. For example, to adjust the volume for output port 06 to level 14, type the following:

**volume o06 v14 [Enter]**

2. To adjust the volume for all output ports to level 04, type the following:

**volume o\* v04 [Enter]**

3. For example, to adjust the volume for output port 06 on device 01 to level 14, type the following:

**volume o06 a01 v14 [Enter]**

The following tables show the possible values for the **Volume** command:

Command	Description
volume	Volume command

Output	Description
o	Output port command

Num1	Description
xx	Output port xx: 01~16 (default is 01)
*	All output ports

Address	Description
a	Device address command (RS-422 and RS-485 only)

Num2	Description
yy	Device address yy: 01~16 (default is 01) (RS-422 and RS-485 only)
*	All devices

Volume	Description
v	Volume level command

Control	Description
zz	Audio volume level zz: 01~10 (default is 10)

- Note:** 1. Each command string can be separated with a space.
2. The **Address** command is for RS-422/485 only. If the address parameter is missing from RS-422/485 commands, the default **a00** will be used. Skip the address for RS-232 commands.

The following table shows the available command list:

Command	Out put	Num1	Address	Num2	Vol- ume	Control	Enter	Description
volume	o	xx *	a	yy *	v	zz	[Enter]	Adjust volume for output port xx, on device yy, to level zz xx:01~16 * yy: 01~16,* zz: 01~16,*

## **Save/Load Profile Commands**

The Save/Load Profile command allows you to save the current connection configuration as a profile and load connection profiles.

The formula for Save/Load Profile commands is as follows:

**Command + Profile + Num1 + Address + Num2 + Control + [Enter]**

1. For example, to save the current connection configuration as profile 08, type the following:

**profile f08 save [Enter]**

2. To load connection profile 04, type the following:

**profile f04 load [Enter]**

3. To save the current connection configuration of device 03 as profile 08, type the following:

**profile f08 a03 save [Enter]**

The following tables show the possible values for commands:

<b>Command</b>	<b>Description</b>
profile	Save / Load Profile command

<b>Profile</b>	<b>Description</b>
f	Profile command

<b>Num1</b>	<b>Description</b>
xx	Profile number xx: 01-64 (default is 01)

<b>Address</b>	<b>Description</b>
a	Device address command (RS-422 and RS-485 only)

<b>Num2</b>	<b>Description</b>
yy	Device address yy: 01~16 (default is 01) (RS-422 and RS-485 only)
*	All devices

<b>Control</b>	<b>Description</b>
save	Save the current connection configuration

Control	Description
load	Load a saved profile

- Note:**
1. Each command string can be separated with a space.
  2. The **Address** command is for RS-422/485 only. If the address parameter is missing from RS-422/485 commands, the default **a00** will be used. Skip the address for RS-232 commands.
  3. If the **Address** or **Profile** parameter is skipped the default value will be used.

The following table shows the available command list:

Command	Profile	Num1	Address	Num2	Control	Enter	Description
profile	f	xx	a	yy *	save	[Enter]	Save current connection configuration on device yy as profile xx xx:01~64 yy: 01~16,*
profile	f	xx	a	yy *	load	[Enter]	Load profile xx on device yy xx:01~64 yy: 01~16,*

## **EDID Mode Command**

Extended Display Identification Data (EDID) is a data that contains a display's basic information and is used to communicate with the video source. The EDID Mode commands allow you to change the EDID setting.

The formula for the EDID command is as follows:

**Command + Address + Number + Control + [Enter]**

1. For example, for port 06 to use the remix EDID mode, type:

**edid a06 remix [Enter]**

1. For example, to use Port1 EDID mode for all devices, type:

2. **edid a\* port1 [Enter]**

The following tables show the possible values for the **EDID** command:

Command	Description
edid	EDID command

Address	Description
a	Device address command (RS-422 and RS-485 only)

Number	Description
zz	Device address zz: 01~16 (default is 01) (RS-422 and RS-485 only)
*	All devices

Control	Description
port1	Implement the EDID of the connected display to Port 1, and pass it to the video source.
remix	Implement the EDID of each connected display according to its connection when the VM3200 is first powered on, or immediately after selecting the Remix option.
default	Implements ATEN's default EDID. (default)
custom	Implements the customized mode as set in the EDID system settings. (See <i>Customized Mode</i> , page 100)

- 
- Note:** 1. Each command string can be separated with a space.
2. The **Address** command is for RS-422/485 only. If the address parameter is missing from RS-422/485 commands, the default **a00** will be used. Skip the address for RS-232 commands.
- 

The following table lists the available EDID commands:

Command	Address	Num	Control	Enter	Description
edid	a	zz *	port1	[Enter]	The EDID from Port 1 is passed to the video source. zz: 01~16
edid	a	zz *	remix	[Enter]	The VM3200 implements the EDID of each connected display according to its connection when the device is first powered on, or immediately after selecting the Remix option.
edid	a	zz *	default	[Enter]	ATEN's default EDID is passed to the video source.
edid	a	zz *	custom	[Enter]	Implements the customized mode.

## **CEC Command**

Consumer Electronics Control (CEC) allows interconnected HDMI devices to communicate and respond to the same remote control.

The formula for the CEC command is as follows:

**Command + Output + Number + Control + [Enter]**

1. For example, to enable the CEC function on output port 1, type:  
**cec o01 on [Enter]**

The following tables show the possible values for the CEC command:

<b>Command</b>	<b>Description</b>
cec	CEC command
<b>Output Command</b>	<b>Description</b>
o	Output port command
<b>Number</b>	<b>Description</b>
yy	Output port 01~16 port (default is 01)
*	All output ports
<b>Control</b>	<b>Description</b>
off	Disable CEC (default)
on	Enable CEC

---

**Note:** Each command string can be separated with a space.

---

The following table lists the available CEC commands:

<b>Command</b>	<b>Output Port</b>	<b>Control</b>	<b>Enter</b>	<b>Description</b>
cec	yy *	off	[Enter]	CEC off for output port yy (default) (yy:01~16, *)
cec	yy *	on	[Enter]	CEC on for output port yy (yy:01~16, *)



## Read Command

The Read command allows you to view information about the devices.

The formula for the Read command is as follows:

**Command + Address + Number + [Enter]**

- To view information, type:

**read [Enter]**

- To view information about device 02, type:

**read a02 [Enter]**

The following table shows the possible values for the **Read** command:

Command	Description
read	Read command
Address	Description
a	Device address command (RS-422 and RS-485 only)
Number	Description
zz	Device address zz: 01~16 (default is 01) (RS-422 and RS-485 only)
*	All Devices

**Note:** The **Address** command is for RS-422/485 only. If the address parameter is missing from RS-422/485 commands, the default **a00** will be used. Skip the address for RS-232 commands.

The following table lists the available Read commands:

Command	Address	Num	Enter	Description
read	a	zz *	[Enter]	View information about device number zz: 01~16

### DVI/HDMI Example:

read Command OK

o01 i03 video on i06 audio v10 HDMI-A on 1080p

o02 i04 video off i06 audio off HDMI-A off bypass

o03 i02 video on i06 audio v10 HDMI-A off 1600

How to read the commands:

1. o01 i03 video on i06 audio v10 HDMI-a on 1080p

**Output 01** is connected to **Input 03** with **video on**; **audio** is **on** from **Input 06** with **volume 10** using the **HDMI** audio source; the resolution is scaled to **1080p**

2. o01 i03 video on i06 audio v10 1080p

**Output 01** is connected to **Input 03** with **video on**; **audio** is on with **volume 10**; the resolution is scaled to **1080p**

3. o02 i04 video off i06 audio off HDMI-a off bypass

**Output 02** is connected to **Input 04** with **video off**; **audio** is **off** from **Input 06** using the **HDMI** audio source; scaling is **bypassed** (turned off)

## Reset Command

The Reset command allows you to reset the VM3200 back to the default factory settings. Reset includes resetting the device's IP address.

The formula for the Reset command is as follows:

**Command + Address + Number + [Enter]**

- To reset the VM3200, type:

**reset [Enter]**

- To reset device 02, type:

**reset a02 [Enter]**

The following tables show the possible values for the **Reset** command:

Command	Description
reset	Reset command
Address	Description
a	Device address command (RS-422 and RS-485 only)
Device Number	Description
zz	Device address zz: 01~16 (default is 01) (RS-422 and RS-485 only)
*	All Devices

**Note:** 1. Each command string can be separated with a space.

- The **Address** command is for RS-422/485 only. If the address parameter is missing from RS-422/485 commands, the default **a00** will be used. Skip the address for RS-232 commands.

The following table lists the available Reset commands:

Command	Address	Num	Enter	Description
reset	a	zz *	[Enter]	Resets the device settings Address; zz: 01~16 (RS-422 and RS-485 only)

## **Baud Rate Command**

The Baud Rate command allows you to set the RS-232 data rate for the VM3200 to use. Options are 9600, 19200 (default) 38400 and 115200.

The formula for the Baud Rate command is as follows:

**Command + Control + [Enter]**

1. For example, to set 38400 as the baud rate, type:

**baud 38400 [Enter]**

The following tables show the possible values for the **Baud Rate** command:

<b>Command</b>	<b>Description</b>
baud	Sets the RS-232 baud rate

<b>Control</b>	<b>Description</b>
9600	Use 9600 baud rate
19200	Use 19200 baud rate
38400	Use 38400 baud rate
115200	Use 115200 baud rate

---

**Note:** Each command string can be separated with a space.

---

The following table lists the available Baud Rate commands:

<b>Command</b>	<b>Control</b>	<b>Enter</b>	<b>Description</b>
baud	9600 / 19200 / 38400 / 115200	[Enter]	Sets the baud rate

## OSD Command

To enable or disable the On-Screen Display (OSD) for displays, use the following command:

**Command + Output + Number + Control + [Enter]**

- For example, to enable the OSD for output 07, type:  
**osd o07 on [Enter]**
- For example, to disable the OSD for all outputs, type:  
**osd o\* off [Enter]**

The following tables show the possible values for the **OSD** command:

Command	Description
osd	OSD command

Output	Description
o	Output port command

Number	Description
yy	Output port 01~16 port (default is 01)
*	All output ports

Control	Description
on	Enable OSD function
off	Disable OSD function (default)

**Note:** Each command string can be separated with a space.

The following table lists the available OSD commands:

Command	Output Port	Control	Enter	Description
osd	yy *	on	[Enter]	OSD on for output yy yy:01~16, *
osd	yy *	off	[Enter]	CEC off for output yy (default) yy:01~16, *

## Echo Command

The Echo function updates the RS232 controller when operations are made via the front panel pushbuttons, web browser or telnet. The changes echo back to the RS232 controller to keep the settings in sync with the device.

The formula for the Echo command is as follows:

**Command + Control + [Enter]**

1. For example, to enable the echo feature, type:

**echo on [Enter]**

The following tables show the possible values for the **Echo** command:

Command	Description
echo	Echo command

Control	Description
on	Turns Echo function on
off	Turns Echo function off (default)

---

**Note:** Each command string can be separated with a space.

---

The following table lists the available Echo commands:

Command	Control	Enter	Description
echo	on	[Enter]	Turn on Echo function
echo	off	[Enter]	Turn off Echo function

## Scaling Command

The Scaling command allows you to set a resolution for scaling the display connected to an output port.

The formula for the Scaling command is as follows:

**Command + Output + Number 1 + Address + Number 2 + Horizontal Resolution + Number 3+ Vertical Resolution + Number 4 + Frequency + Number 5 + Control + [Enter]**

1. For example, to turn scaling off for output port 02, type:  
**scaling o02 off [Enter]**
2. To set the scaling for output port 04 to 1920x1080@60Hz, type:  
**scaling o04 1080p [Enter]**
3. To set the scaling for all output ports on all devices to the connected display's native resolution, type:  
**scaling o\* a\* native [Enter]**

The following tables show the possible values for the **Scaling** command:

Command	Description
scaling	Scaling command

Output	Description
o	Output command

Num1	Description
yy	Output port yy: 01~16 (default is 01)
*	All output ports

Address	Description
a	Device address command (RS-422 and RS-485 only)

Num2	Description
zz	Device Address zz: 01~16 (RS-422 and RS-485 only)
*	All Devices

Horizontal Resolution	Description
hor	Horizontal resolution command for scaling

Resolution Number	Description
hhhh	Horizontal resolution

Vertical Resolution	Description
ver	Vertical resolution command for scaling

Resolution Number	Description
vvvv	Vertical resolution

Frequency	Description
freq	Frequency command for scaling

Frequency Number	Description
fff	Frequency resolution

Horizontal Resolution	Description
hor	Horizontal resolution command for scaling

Control	Description
off	Turn off the scaling function (by pass mode)
native	Map display's native resolution for scaling (default)

- 
- Note:** 1. Each command string can be separated with a space.
2. The **Address** command is for RS-422/485 only. If the address parameter is missing from RS-422/485 commands, the default **a00** will be used. Skip the address for RS-232 commands.



3. The **Port Number** command string can be skipped, and the default value will be used.

The following table lists the available Scaling commands:

Com	Out	N1	Add	N2	Horizontal Res	N3	Vertical Res	N4	Frequency	N5	Cont	Enter	Description
scaling	o	yy*	a	zz*	hor		ver		freq		off	[Enter]	Turn off scaling for output yy device zz (by pass mode)  yy: 01~16 or * zz: 01~16 or *
scaling	o	yy*	a	zz*	hor		ver		freq		native	[Enter]	Enable display's native resolution for scaling on output yy device zz (default)  yy: 01~16 or * zz: 01~16 or *
scaling	o	yy*	a	zz*	hor	1920	ver	1080	freq	60		[Enter]	Scale output yy device zz to 1920x1080@60Hz  yy: 01~16 or * zz: 01~16 or *

Com	Out	N1	Add	N2	Horizontal Res	N3	Vertical Res	N4	Frequency	N5	Cont	Enter	Description
scaling	o	yy*	a	zz*	hor	1280	ver	720	freq	60		[Enter]	Scale output yy device zz to 1280x720 @60Hz yy: 01~16 or * zz: 01~16 or *
scaling	o	yy*	a	zz*	hor	1920	ver	1200	freq	60		[Enter]	Scale output port yy device zz to 1920x1200 @60Hz yy: 01~16 or * zz: 01~16 or *
scaling	o	yy*	a	zz*	hor	1600	ver	1200	freq	60		[Enter]	Scale output yy device zz to 1600x1200 @60Hz yy: 01~16 or * zz: 01~16 or *
scaling	o	yy*	a	zz*	hor	1400	ver	1050	freq	60		[Enter]	Scale output yy device zz to 1400x1050 @60Hz yy: 01~16 or * zz: 01~16 or *

Com	Out	N1	Add	N2	Horizontal Res	N3	Vertical Res	N4	Frequency	N5	Cont	Enter	Description
scaling	o	yy*	a	zz*	hor	1280	ver	1024	freq	60		[Enter]	Scale output yy device zz to 1280x1024@60Hz yy: 01~16 or * zz: 01~16 or *
scaling	o	yy*	a	zz*	hor	1024	ver	768	freq	60		[Enter]	Scale output yy device zz to 1024x768@60Hz yy: 01~16 or * zz: 01~16 or *

## **Fan Speed Command**

The Fan Speed command allows you to set the VM3200's internal fan speed.

To set the fan speed, use the following command:

**Command + Control + [Enter]**

1. For example, to set the fan to auto detect, type:

**fan auto [Enter]**

The following tables show the possible values for the **Fan Speed** command:

<b>Command</b>	<b>Description</b>
fan	Fan Speed Command

<b>Control</b>	<b>Description</b>
low	Set internal fan to low speed
mid	Set internal fan to normal speed
high	Set internal fan to high speed
auto	Set internal fan to auto detect (default)

---

**Note:** Each command string can be separated with a space.

---

The following table lists the available Fan Speed commands:

<b>Command</b>	<b>Control</b>	<b>Enter</b>	<b>Description</b>
fan	low	[Enter]	Sets fan speed to low
fan	mid	[Enter]	Sets fan speed to normal
fan	high	[Enter]	Sets fan speed to high
fan	auto	[Enter]	Sets fan speed to auto detect (default)

## Alert Command

To trigger a warning when issues arise for a specific input port, use the following command:

**Command + Input + Number + Control + [Enter]**

- For example, to enable the basic Alert function for input port 1, type:

**alert i01 m1 [enter]**

The following tables show the possible values for the **Alert** command:

Command	Description
alert	Alert command
Input	Description
i	Input command
Port number	Description
yy	01-16 port
Control	Description
off	Disable Alert (default)
m1	Show basic Alert (flashing border)
m2	Show detailed Alert (flashing border and port information)

**Note:** Each command string can be separated with a space.

The following table lists the available Alert commands:

Command	Input Command	Input Port	Control	Enter	Description
alert	i	yy	off	[Enter]	Alert off for input port yy (yy:01~16)
alert	i	yy	m1	[Enter]	Basic Alert on for input port yy (yy:01~16)
alert	i	yy	m2	[Enter]	Detailed Alert on for input port yy (yy:01~16)

This Page Intentionally Left Blank

## Safety Instructions

---

### General

- ◆ Read all of these instructions. Save them for future reference.
- ◆ Follow all warnings and instructions marked on the device.
- ◆ This product is for indoor use only.
- ◆ Do not place the device on any unstable surface (cart, stand, table, etc.). If the device falls, serious damage will result.
- ◆ Do not use the device near water.
- ◆ Do not place the device near, or over, radiators or heat registers.
- ◆ The device cabinet is provided with slots and openings to allow for adequate ventilation. To ensure reliable operation, and to protect against overheating, these openings must never be blocked or covered.
- ◆ The device should never be placed on a soft surface (bed, sofa, rug, etc.) as this will block its ventilation openings. Likewise, the device should not be placed in a built in enclosure unless adequate ventilation has been provided.
- ◆ Never spill liquid of any kind on the device.
- ◆ Unplug the device from the wall outlet before cleaning. Do not use liquid or aerosol cleaners. Use a damp cloth for cleaning.
- ◆ The device should be operated from the type of power source indicated on the marking label. If you are not sure of the type of power available, consult your dealer or local power company.
- ◆ The device is designed for IT power distribution systems with 230V phase-to-phase voltage.
- ◆ To prevent damage to your installation it is important that all devices are properly grounded.
- ◆ The device is equipped with a 3-wire grounding type plug. This is a safety feature. If you are unable to insert the plug into the outlet, contact your electrician to replace your obsolete outlet. Do not attempt to defeat the purpose of the grounding-type plug. Always follow your local/national wiring codes.
- ◆ Do not allow anything to rest on the power cord or cables. Route the power cord and cables so that they cannot be stepped on or tripped over.

- ◆ If an extension cord is used with this device make sure that the total of the ampere ratings of all products used on this cord does not exceed the extension cord ampere rating. Make sure that the total of all products plugged into the wall outlet does not exceed 15 amperes.
- ◆ To help protect your system from sudden, transient increases and decreases in electrical power, use a surge suppressor, line conditioner, or un-interruptible power supply (UPS).
- ◆ Position system cables and power cables carefully; Be sure that nothing rests on any cables.
- ◆ Never push objects of any kind into or through cabinet slots. They may touch dangerous voltage points or short out parts resulting in a risk of fire or electrical shock.
- ◆ Do not attempt to service the device yourself. Refer all servicing to qualified service personnel.
- ◆ If the following conditions occur, unplug the device from the wall outlet and bring it to qualified service personnel for repair.
  - ◆ The power cord or plug has become damaged or frayed.
  - ◆ Liquid has been spilled into the device.
  - ◆ The device has been exposed to rain or water.
  - ◆ The device has been dropped, or the cabinet has been damaged.
  - ◆ The device exhibits a distinct change in performance, indicating a need for service.
  - ◆ The device does not operate normally when the operating instructions are followed.
- ◆ Only adjust those controls that are covered in the operating instructions. Improper adjustment of other controls may result in damage that will require extensive work by a qualified technician to repair.
- ◆ Avoid circuit overloads. Before connecting equipment to a circuit, know the power supply's limit and never exceed it. Always review the electrical specifications of a circuit to ensure that you are not creating a dangerous condition or that one does not already exist. Circuit overloads can cause a fire and destroy equipment.



## **Rack Mounting**

- ◆ Before working on the rack, make sure that the stabilizers are secured to the rack, extended to the floor, and that the full weight of the rack rests on the floor. Install front and side stabilizers on a single rack or front stabilizers for joined multiple racks before working on the rack.
- ◆ Always load the rack from the bottom up, and load the heaviest item in the rack first.
- ◆ Make sure that the rack is level and stable before extending a device from the rack.
- ◆ Do not overload the AC supply branch circuit that provides power to the rack. The total rack load should not exceed 80 percent of the branch circuit rating.
- ◆ Make sure that all equipment used on the rack – including power strips and other electrical connectors – is properly grounded.
- ◆ Ensure that proper airflow is provided to devices in the rack.
- ◆ Ensure that the operating ambient temperature of the rack environment does not exceed the maximum ambient temperature specified for the equipment by the manufacturer.
- ◆ Do not step on or stand on any device when servicing other devices in a rack.

## Technical Support

---

### International

- ◆ For online technical support – including troubleshooting, documentation, and software updates: **<http://eservice.aten.com>**
- ◆ For telephone support, see *Telephone Support*, page xi:

### North America

Email Support		<a href="mailto:support@aten-usa.com">support@aten-usa.com</a>
Online Technical Support	Troubleshooting Documentation Software Updates	<a href="http://www.aten-usa.com/support">http://www.aten-usa.com/support</a>
Telephone Support		1-888-999-ATEN ext 4988

When you contact us, please have the following information ready beforehand:

- ◆ Product model number, serial number, and date of purchase.
- ◆ Your computer configuration, including operating system, revision level, expansion cards, and software.
- ◆ Any error messages displayed at the time the error occurred.
- ◆ The sequence of operations that led up to the error.
- ◆ Any other information you feel may be of help.

# Specifications

## VM3200

Function		VM3200
Board Input		8 x Slot
Board Output		8 x Slot
Video Input	Interface	Depends on which I/O board is inserted
	Impedance	100 $\Omega$
	Maximum Data Rate	10.2 Gbps (3.4 Gbps per lane)
	Maximum Pixel Clock	340 MHz
	Compliance	HDMI (3D, Deep Color, 4K) HDCP 1.4 Compatible Consumer Electronics Control (CEC) HDBaseT Compatible
Audio	Input	Depends on which Input board is inserted
	Output	Depends on which Output board is inserted
Control	RS-232	Connector: 1 x DB-9 Female (Black) Serial Control Pin Configurations: Pin2 = Tx, Pin 3=Rx, Pin 5= Gnd Baud Rate and Protocol: Baud Rate:19200, Data Bits:8, Stop Bits:1, Parity: No, Flow Control: No
	RS-485/RS-422	Connector: 1 x Captive Screw Connector, 5 Pole
	Ethernet	Connector: 1 x RJ-45 Female
EDID Settings		EDID Mode: Default / Port1 / Remix / Customized (EDID Wizard support)
Power	Connectors	1 x 3-Prong AC Socket
	I/P Rating	100-240 VAC; 50-60Hz; 10A (Max)
	Maximum Consumption	800W *A power module can be purchased for power redundancy.
Fan		Airflow: 55.2 cfm Operating Voltage: 10.8 - 13.8 VDC Operating Temp: -10–70°C

<b>Function</b>		<b>VM3200</b>
Environmental	Operating Temperature	0–40°C
	Storage Temperature	-20–60°C
	Humidity	0–80% RH, Non-condensing
Physical Properties	Housing	Metal
	Weight	18.20 kg (chassis only)
	Dimensions (L x W x H)	48.20 x 47.19 x 39.90 cm

**VM7514 / VM8514**

Function	VM7514	VM8514
<b>Video Input</b>		
Interfaces	4 x RJ-45 Female (Silver)	N/A
Impedance	100 $\Omega$	N/A
<b>Video Output</b>		
Interfaces	N/A	4 x RJ-45 Female (Silver)
Impedance	N/A	100 $\Omega$
<b>Video</b>		
Max. Data Rate	10.2 Gbps (3.4 Gbps per lane)	
Max. Pixel Clock	340 MHz	
Compliance	HDBaseT, HDCP 1.4 compatible Consumer Electronics Control (CEC)	
Max. Resolution	4096 x 2160 / 3840 x 2160 @ 60Hz (4:2:0); 4096 x 2160 / 3840 x 2160 @ 30Hz (4:4:4)	
Max. Distance	100 m (Cat 6a)	
<b>Control</b>		
RS-232	4 x Captive Screw Connectors, 3 pole	
IR	4 x Mini Stereo Jack Female (Black)	
<b>Power</b>		
Consumption	24.5W	12.2W
<b>Environmental</b>		
Operating Temperature	0 - 40°C	
Storage Temperature	-20 - 60°C	
Humidity	0 - 80% RH, Non-Condensing	
<b>Physical Properties</b>		
Housing	Metal	
Weight	0.64 kg / 1.41 lb	0.97 kg / 2.14 lb
Dimensions (L x W x H)	35.20 x 23.80 x 2.33 cm / 13.86 x 9.37 x 0.92 in.	

**VM7814 / VM8814**

Function	VM7814	VM8814
<b>Video Input</b>		
Interfaces	4 x HDMI Type A Female (Black)	N/A
Impedance	100 $\Omega$	N/A
Max. Distance	Up to 5m	Up to 15m
<b>Video Output</b>		
Interfaces	N/A	4 x HDMI Type A Female (Black)
Impedance	N/A	100 $\Omega$
<b>Video</b>		
Max. Data Rate	10.2 Gpbs (3.4 Gpbs per Lane)	
Max. Pixel Clock	340 MHz	
Compliance	HDMI (3D, Deep Color, 4K) HDCP 2.2 Compatible Consumer Electronics Control (CEC)	
Max. Resolution	4096 x 2160 / 3840 x 2160 @60Hz (4:2:0) 4096 x 2160 / 3840 x 2160 @30Hz (4:4:4)	
<b>Audio</b>		
Input	4 x Captive Screw Connector, 5 Pole	N/A
Output	N/A	4 x Captive Screw Connector, 5 Pole
Audio Signal Type	stereo, balanced, unbalanced	
<b>Power</b>		
Consumption	4.45W	20W
<b>Environmental</b>		
Operating Temperature	0 - 40°C	
Storage Temperature	-20 - 60°C	
Humidity	0 - 80% RH, Non-Condensing	
<b>Physical Properties</b>		
Housing	Metal	
Weight	0.56 kg / 1.23 lb	
Dimensions (L x W x H)	35.20 x 23.80 x 2.33 cm / 13.86 x 9.37 x 0.92 in.	

**VM7804 / VM8804**

Function	VM7804	VM8804
<b>Video Input</b>		
Interfaces	4 x HDMI Type A Female (Black)	N/A
Impedance	100 $\Omega$	N/A
<b>Video Output</b>		
Interfaces	N/A	4 x HDMI Type A Female (Black)
Impedance	N/A	100 $\Omega$
<b>Video</b>		
Max. Data Rate	6.75 Gpbs (2.25 Gpbs per Lane)	
Max. Pixel Clock	225 MHz	
Compliance	HDMI (3D, Deep Color) HDCP 1.4 Compatible Consumer Electronics Control (CEC)	
Max. Resolution	1920 x 1080	
Max. Distance	15 m	
<b>Audio</b>		
Input	4 x Captive Screw Connector, 5 Pole	N/A
Output	N/A	4 x Captive Screw Connector, 5 Pole
Audio Signal Type	stereo, balanced, unbalanced	
<b>Power</b>		
Consumption	7W	23.13W
<b>Environmental</b>		
Operating Temperature	0 - 40°C	
Storage Temperature	-20 - 60°C	
Humidity	0 - 80% RH, Non-Condensing	
<b>Physical Properties</b>		
Housing	Metal	
Weight	0.58 kg / 1.28 lb	
Dimensions (L x W x H)	35.20 x 23.80 x 2.33 cm / 13.86 x 9.37 x 0.92 in.	

**VM7604 / VM8604**

Function	VM7604	VM8604
<b>Video Input</b>		
Interfaces	4 x DVI-D Female (White)	N/A
Impedance	100 Ω	N/A
<b>Video Output</b>		
Interfaces	N/A	4 x DVI-D Female (White)
Impedance	N/A	100 Ω
<b>Video</b>		
Max. Data Rate	6.75 Gbps (2.25 Gbps per Lane)	
Max. Pixel Clock	225 MHz	
Compliance	HDCP 1.4 Compatible	
Max. Resolution	1920 x 1200	
Max. Distance	5 m	
<b>Audio</b>		
Input	4 x Captive Screw Connector, 5 Pole	N/A
Output	N/A	4 x Captive Screw Connector, 5 Pole
Audio Signal Type	stereo, balanced, unbalanced	
<b>Power</b>		
Consumption	10.62W	20.10W
<b>Environmental</b>		
Operating Temperature	0 - 40°C	
Storage Temperature	-20 - 60°C	
Humidity	0 - 80% RH, Non-Condensing	
<b>Physical Properties</b>		
Housing	Metal	
Weight	0.55 kg / 1.21 lb	
Dimensions (L x W x H)	35.20 x 23.80 x 2.33 cm / 13.86 x 9.37 x 0.92 in.	



**VM7104**

Function	VM7104
<b>Video Input</b>	
Interfaces	4 x HDB-15 Female (Blue)
Impedance	75 $\Omega$
Max. Bandwidth	300 MHz
Max. Resolution	1920 x 1200
Max. Distance	1.8 m
<b>Audio Input</b>	
Interfaces	4 x Captive Screw Connector, 5 Pole
Audio Signal Type	stereo, balanced, unbalanced*
<b>Power</b>	
Consumption	7.1W
<b>Environmental</b>	
Operating Temperature	0 - 40°C
Storage Temperature	-20 - 60°C
Humidity	0 - 80% RH, Non-Condensing
<b>Physical Properties</b>	
Housing	Metal
Weight	0.56 kg / 1.23 lb
Dimensions (L x W x H)	35.20 x 23.80 x 2.33 cm / 13.86 x 9.37 x 0.92 in.

**Note:** The maximum audio input is 0.5 V<sub>rms</sub> (- 6.02 dBV @600 ohm) for balanced audio and 1 V<sub>rms</sub> (0 dBv @600 ohm) for unbalanced audio.

**VM7404**

Function	VM7404
<b>Video Input</b>	
Interfaces	4 x BNC Female
Impedance	75 $\Omega$
<b>Video</b>	
Supported Resolutions	PAL /50 PAL and NTSC/59.94 720p 25, 29.97, 30,50,59.94, 60 1080i 50, 59.94, 60 1080PsF 25, 29.97,30 1080p 23.98, 24, 25, 29.97, 30,50,59.94, 60
Max. Data Rate	2.97 Gpbs
Max. Distance	100m (3G-SDI), 150m (HD-SDI), 300m (SD-SDI)
<b>SDI Formats</b>	3G-SDI, SMPTE-259,292,424, 425 Level A & B-DL
<b>Audio Input</b>	
Interfaces	4 x Captive Screw Connector, 5 Pole
Audio Signal Type	stereo, balanced, unbalanced*
<b>Power</b>	
Consumption	16.0W
<b>Environmental</b>	
Operating Temperature	0 - 40°C
Storage Temperature	-20 - 60°C
Humidity	0 - 80% RH, Non-Condensing
<b>Physical Properties</b>	
Housing	Metal
Weight	0.60 kg / 1.32 lb
Dimensions (L x W x H)	35.20 x 23.80 x 2.33 cm / 13.86 x 9.37 x 0.92 in.

**Note:** The maximum audio input is 0.5 Vrms (- 6.02 dBV @600 ohm) for balanced audio and 1 Vrms (0 dBv @600 ohm) for unbalanced audio.

**VE805R**

Function	VE805R
<b>Video Input</b>	
Interfaces	1 x RJ-45 Female (Silver)
Impedance	100 $\Omega$
<b>Video Output</b>	
Interfaces	1 x HDMI Type A Female (Black)
Impedance	100 $\Omega$
<b>Video</b>	
Max. Data Rate	6.75 Gpbs (2.25 Gpbs per Lane)
Max. Pixel Clock	225 MHz
Compliance	HDMI (3D, Deep Color) HDCP 1.4 Compatible HDBaseT Compatible
Max. Resolution / Distance	1080p @60m (Cat 5e/6) 1080p @70m (Cat 7)
<b>Control</b>	
RS-232	1 x Captive Screw Connector, 3 Pole
IR	1 x Mini Stereo Jack Female (Black)
<b>Power</b>	
Connectors	1 x DC Jack (Sliver)
Consumption	5 VDC, 9.5W
<b>Environmental</b>	
Operating Temperature	0 - 50°C
Storage Temperature	-20 - 60°C
Humidity	0 - 80% RH, Non-Condensing
<b>Physical Properties</b>	
Housing	Metal
Weight	0.81 kg / 1.78 lb
Dimensions (L x W x H)	17.74 x 16.92 x 4.20 cm / 6.98 x 6.66 x 1.65 in.

## **VM-PWR800**

<b>Function</b>		<b>VM-PWR800</b>
Properties	Input Voltage	100~240Vac
	Power Consumption	Max.Load 800W
	Operating Temp.	0–40°C

## **VM-FAN556**

<b>Function</b>		<b>VM-FAN556</b>
Properties	Air Flow	55.2 cfm
	Operating Voltage	10.2 - 12 Vdc
	Operating Temp.	-10 - 60°C

---

## Limited Warranty

---

ATEN warrants its hardware in the country of purchase against flaws in materials and workmanship for a Warranty Period of two [2] years (warranty period may vary in certain regions/countries) commencing on the date of original purchase. This warranty period includes the LCD panel of ATEN LCD KVM switches. Select products are warranted for an additional year (see *A+ Warranty* for further details). Cables and accessories are not covered by the Standard Warranty.

### **What is covered by the Limited Hardware Warranty**

ATEN will provide a repair service, without charge, during the Warranty Period. If a product is defective, ATEN will, at its discretion, have the option to (1) repair said product with new or repaired components, or (2) replace the entire product with an identical product or with a similar product which fulfills the same function as the defective product. Replaced products assume the warranty of the original product for the remaining period or a period of 90 days, whichever is longer. When the products or components are replaced, the replacing articles shall become customer property and the replaced articles shall become the property of ATEN.

To learn more about our warranty policies, please visit our website:  
<http://www.aten.com/global/en/legal/policies/warranty-policy/>