

hear
TECHNOLOGIES®

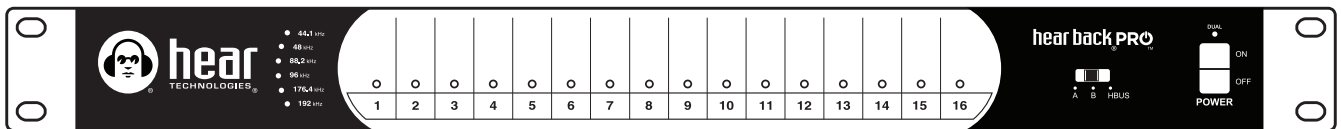

hear back PRO™

PERSONAL MONITOR MIXER SYSTEM

Firmware Version 1.0-5.X

user guide

ENGLISH

Danger

Exposure to extremely high noise levels may cause a permanent hearing loss. Individuals vary considerably to noise induced hearing loss but nearly everyone will lose some hearing if exposed to sufficiently intense noise for a sufficient time.

The U.S. Government's Occupational Safety and Health Administration (OSHA) has specified the following permissible noise level exposures:

DURATION PER DAY (HOURS)	8	6	4	3	2	1
SOUND LEVEL (dB)	90	93	95	97	100	103

According to OSHA, any exposure in the above permissible limits could result in some hearing loss. Ear plugs or protectors in the ear canal or over the ears must be worn when operating this amplification system in order to prevent a permanent hearing loss. If exposure in excess of the limits as put forth above, to insure against potentially harmful exposure to high sound pressure levels, it is recommended that all persons exposed to equipment capable of inducing high sound pressure levels, such as this amplification system, be protected by hearing protectors while this unit is in operation.

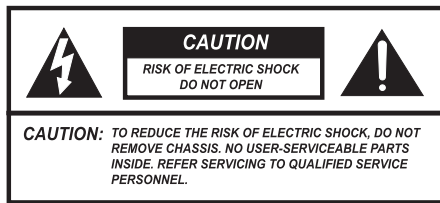

AVIS: RISQUE DE CHOC ELECTRIQUE-NE PAS OUVRIR.



THIS SYMBOL IS INTENDED TO ALERT THE USER TO THE PRESENCE OF NON-INSULATED "DANGEROUS VOLTAGE" WITHIN THE PRODUCT'S ENCLOSURE THAT MAY BE OF SUFFICIENT MAGNITUDE TO CONSTITUTE A RISK OF ELECTRIC SHOCK TO PERSONS.



THIS SYMBOL IS INTENDED TO ALERT THE USER TO THE PRESENCE OF IMPORTANT OPERATING AND MAINTENANCE (SERVICING) INSTRUCTIONS IN THE LITERATURE ACCOMPANYING THE UNIT.

IMPORTANT SAFETY INSTRUCTIONS

1. Read all safety and operating instructions before using this product.
2. All safety and operating instructions should be kept for future reference.
3. Read and understand all warnings listed on the operating instructions.
4. Follow all operating instructions to operate this product.
5. This product should not be used near water, i.e. bathtub, sink, swimming pool, wet basement, etc.
6. Only use dry cloth to clean this product.
7. Do not block any ventilation openings. It should not be placed flat against a wall or placed in a built-in enclosure that will impede the flow of cooling air.
8. Do not install this product near any heat sources; such as, radiators, heat registers, stove or other apparatus (including heat producing amplifiers) that produce heat.
9. Do not defeat the safety purpose of the polarized or grounding-type plug. A polarized plug has two blades with one wider than the other. A grounding-type plug has two blades and a third grounding prong. The wide blade or the third prong are provided for your safety. If the provided plug does not fit into your outlet, consult an electrician for replacement of the obsolete outlet.
10. Protect the power cord being walked on or pinched, particularly at plugs, convenience receptacles and the point where they exit from the apparatus. Do not break the ground pin of the power supply cord.
11. Only use attachments specified by the manufacturer.
12. Use only with the cart, stand, tripod, bracket, or table specified by the manufacturer or sold with the apparatus. When a cart is used, use caution when moving cart/apparatus combination to avoid injury from tip-over.
13. Unplug this apparatus during lightning storms or when unused for long periods of time.
14. Care should be taken so that objects do not fall and liquids are not spilled into the unit through the ventilation ports or any other openings.
15. Refer all servicing to qualified service personnel. Servicing is required when the apparatus has been damaged in any way; such as, power-supply cord or plug is damaged, liquid has been spilled or objects have fallen into the apparatus, the apparatus has been exposed to rain or moisture, does not operate normally, or has been dropped.
16. **WARNING:** To reduce the risk of fire or electric shock, do not expose this apparatus to rain or moisture.
17. The apparatus shall be connected to a mains socket outlet with a protective earthing connection.
18. Mains plug is used as the disconnect device. It shall remain readily operable and should not be obstructed during intended use.
19. **WARNING:** To prevent injury, this apparatus must be securely attached to a rack in accordance with the installation instructions.
20. Detailed installation instruction in user manual.

FRENCH

Danger

L'exposition a des niveaux eleves de bruit peut provoquer une perte permanente de l'audition. Chaque organisme humain reagit differemment quant a la perte de l'audition, mais quasiment tout le monde subit une diminution de l'acuite auditive lors d'une exposition suffisamment longue au bruit intense. Les autorites competentes en reglementation de bruit ont defini les expositions tolerees aux niveaux de bruits:

DURE EN HEURES PAR JOUR	8	6	4	3	2	1
NIVEAU SONORE CONTINU EN dB	90	93	95	97	100	103

Selon les autorites, toute exposition dans les limites citees ci-dessus, peuvent provoquer certaines pertes d'audition. Des bouchons ou protections dans l'appareil auditif ou sur l'oreille doivent etre portes lors de l'utilisation de ce systeme d'amplification afin de prevenir le risque de perte permanente de l'audition. Dans le cas d'expositions superieures aux limites precitees il est recommande, afin de se premunir contre les expositions aux pressions acoustiques elevees potentiellement dangeereuses, aux personnes exposees aux equipements capables de delivrer de telles puissances, tels ce systeme d'amplification en fonctionnement, de proteger l'appareil auditif.



CE SYMBOLE A POUR BUT D'AVERTIR L'UTILISATEUR DE LA PRESENCE DE VOLTAGE DANGEREUX NON-ISOLE A L'INTERIEUR DE CE PRODUIT QUI PEUT ETRE DE PUISSANCE SUFFISAMMENT IMPORTANTE POUR PROVOQUER UN CHOC ELECTRIQUE AUX PERSONNES.



CE SYMBOLE A POUR BUT D'AVERTIR L'UTILISATEUR DE LA PRESENCE D'INSTRUCTIONS D'UTILISATION ET DE MAINTENANCE DANS LES DOCUMENTS FOURNIS AVEC CE PRODUIT.

IMPORTANTES INSTRUCTIONS DE SECURITE

1. Lire avec attention toutes les recommandations et precautions d'emploi avant d'utiliser ce produit.
2. Toutes les recommandations et precautions d'emploi doivent etre conservees afin de pouvoir s'y reporter si necessaire.
3. Lire et comprendre tous les avertissements enumerés dans les precautions d'emploi.
4. Suivre toutes les precautions d'emploi pour utiliser ce produit.
5. Ce produit ne doit pas etre utilise pres d'eau, comme par exemple baignoires, eviers, piscine, sous-sol humides...etc.
6. Utiliser exclusivement un chiffon sec pour nettoyer ce produit.
7. Ne bloquer aucune ouverture de ventilation. Ne pas placer le produit tout contre un mur ou dans une enceinte fermee, cela generait le flux d'air necessaire au refroidissement.

8. Ne pas placer le produit pres de toute source de chaleur telle que radiateurs, arrivees d'air chaud, fourneaux ou autres appareils generant de la chaleur (incluant les amplificateurs producteurs de chaleur).
9. Ne pas negliger la securite que procure un branchement polarise ou avec raccordement a la terre. Un branchement polarise comprend deux fiches dont l'une est plus large que l'autre. Un branchement a la terre comprend deux fiches plus une troisieme reliee a la terre. Si la fiche secteur fournie ne s'insert pas dans votre prise de courant, consulter un electricien afin de remplacer votre prise obsolete.
10. Protéger le cordon d'alimentation de tout ecrasement ou pincement, particulierement au niveau des fiches, des receptacles utilises et a l'endroit de sortie de l'appareil. Ne pas casser la fiche de terre du cordon d'alimentation.
11. Utiliser uniquement les accessoires specifiés par le constructeur.
12. Utiliser uniquement avec le chariot de transport, le support, le trepied, la console ou la table specifiés par le constructeur ou vendus avec l'appareil. Lors de l'utilisation d'un chariot, bouger avec precaution l'ensemble chariot/appareil afin d'éviter les dommages d'un renversement.
13. Débrancher cet appareil lors d'orages ou s'il n'est pas utilise pendant une longue periode.
14. Des precautions doivent etre prises afin qu'aucun objet ne tombe et qu'aucun liquide ne se repande a l'interieur de l'appareil par les orifices de ventilation ou n'importe quelle autre ouverture.
15. Pour toutes interventions techniques s'adresser a un technicien qualifié. L'intervention technique est necessaire lorsque l'appareil a été endommagé de n'importe quelle façon, comme par exemple si le cordon secteur ou sa fiche sont detériorés, si du liquide a coulé ou si des objets sont tombés a l'interieur de l'appareil, si l'appareil a été expose a la pluie ou a l'humidité, s'il ne fonctionne pas normalement ou s'il est tombé.
16. ATTENTION: Pour réduire le risque d'incendie ou de choc électrique ne pas exposer l'appareil a la pluie ou a l'humidité.
17. L'appareil sera relie a un socle principal d'électricité muni d'une mise a terre protectrice.
18. Le cordon d'alimentation est utilisée comme dispositif de débranchement. Il restera aisément fonctionnelle et ne devrait pas être obstrué pendant l'utilisation prévue.
19. AVERTISSEMENT Pour raison de securite, cet appareil doit être solidement fixé a un rack selon les instructions d'installation.
20. Instruction d'installation détaillée a l'interieur du manuel d'utilisateur.

ELECTROMAGNETIC COMPATIBILITY

This device complies with part 15 of the FCC Rules and the Product Specifications noted on the Declaration of Conformity. Operation is subject to the following two conditions:

- this device may not cause harmful interference, and
- this device must accept any interference received, including interference that may cause undesired operation.

Operation of this unit within significant electromagnetic fields should be avoided.

- use only shielded interconnecting cables.

WARNING

The Hub unit produces heat while powered, and therefore requires adequate ventilation to ensure the internal temperature stays within maximum operating temperatures (0° C to 54.5° C, or 32° F to 130° F).

Please ensure that these clearances are met:

- 0.85 inches of clearance on either side of Hub
- 1 inch of clearance in front of Hub
- 11 inches of clearance in back of Hub

Care should be taken so that the Mixer's ventilation holes remain unblocked, allowing adequate airflow through both sides of the unit.

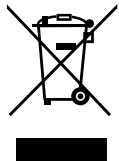

If you want to dispose this product, do not mix it with general household waste. There is a separate collection system for used electronic products in accordance with legislation that requires proper treatment, recovery and recycling.

Private household in the 25 member states of the EU, in Switzerland and Norway may return their used electronic products free of charge to designated collection facilities or to a retailer (if you purchase a similar new one).

For countries not mentioned above, please contact your local authorities for a correct method of disposal.

By doing so, you will ensure that your disposed product under goes the necessary treatment, recovery and recycling and thus prevent potential negative effects on the environment and human health.

DECLARATION OF CONFORMITY

Manufacturer's Name: Hear Technologies
Manufacturer's Address: 991 Discovery Dr.
Huntsville, AL 35806, USA

Declares that the product:

Product Name: Hear Back PRO
Product Option: All (requires Class II power adapter that conforms to the requirements of EN60065, EN60742, or equivalent.)

Conforms to the following Product Specifications:

Safety: IEC 60065 -01+Amd 1
EMC: EN 55022:2010
55024:2010
FCC Part 15

Supplementary Information:

The product herewith complies with the requirements of the:
Low Voltage Directive 2006/95/EC
EMC Directive 2004/108/EC
RoHS Directive 2002/95/EC
WEEE Directive 2002/96/EC
EC Regulation 278/2009

With regard to Directive 2005/32/EC and EC Regulation 1275/2008 of 17 December 2008, this product is designed, produced, and classified as Professional Audio Equipment and thus is exempt from this Directive.

Nason Tackett
Senior Design Engineer
Hear Technologies
991 Discovery Drive
Huntsville, AL 35806, USA
Date: August 15, 2014

A FEW NOTES ABOUT THE SYSTEM

- Do not share the network with any other devices.
 - High-quality, low-latency audio requires a constant stream of large amounts of data; therefore, other devices on the same network could compromise the quality of the audio.
- **The system will not link at 10/100 Mbps, as it is designed to work at gigabit speeds.**
- The system is designed to work with suitable unshielded CAT6* cable complying with the National authorities (cable with an outer jacket or sleeving rated VW-1 or better). Note, using low-quality cables may result in the Mixers refusing to link with the Hub.
- Do not use shielded CAT6* cables which can cause ground-loops.
- Unshielded CAT6* cables, used for HBUS or going to PRO Mixers, can be run 100 meters (328 feet) with no problems. Note, due to advanced internal termination techniques, cables used with the PRO series can be run up to 500 feet in ideal conditions (one piece of solid conductor CAT6* with no breaks or couplings). Utilizing proper punch-down and the correct RJ-45 connectors is key. The more breaks/connections/couplings in a cable run, the more limited this distance will be. Poor quality cabling will also limit the maximum distance. Running unshielded CAT6* cables alongside AC cables, fluorescent light fixtures, or computer network wiring will also limit the maximum distance. It is always preferred to run the Hear Back PRO CAT6* cabling by itself, away from other cabling. ALL cabling should be electrically tested before use. Contact an expert network professional for assistance with wiring installation.
- Don't use those old, gray, flat telephone cables (ISDN cables) as those are not gigabit Ethernet cables.
- The ground and power rails of the Mixer are totally isolated from the Hub, meaning no more ground loops to worry about.
- Mixer faceplate can be labeled by using a dry erase marker (simply wipe off), grease pens (erase with pencil eraser), label maker, or by writing on a removable Mixer overlay. Please note that using permanent markers results in permanent labels!

iOS APP NOW AVAILABLE

Control Hear Back PRO Mixers, simply by connecting your PRO Hub to a wireless network! This streamlined interface enables routing and submixing of up to 128 channels, naming Mixers & channels, grouping, lockout controls, LED brightness adjustment, and firmware (FW) updates.

For **FW V2** (16-channel), minimum firmware requirements:

- Hub: V2.3 (download from www.hearback.com/support)
- Mixer: V2.14 (<https://youtu.be/V9uKnRFa4SE>)

For **FW V5** (128-channel), minimum firmware requirements:

- Hub: V5.1 (bootloader 2.3)
- Mixer: V5.1 (bootloader 2.24)

If your current Mixer firmware is below V2.14, call or email us to request a Firmware Update Card.

Tel: +1 (256) 922-1200 ext. 135

Email: support@HearTechnologies.com



Scan code to download from iTunes or Search App Store for "Hear Back PRO"

FCC STATEMENT

Note: This equipment has been tested and found to comply with the limits for a Class A digital device, pursuant to part 15 of the FCC Rules. These limits are designed to provide reasonable protection against harmful interference in a commercial installation. This equipment generates, uses and can radiate radio frequency energy and, if not installed and used in accordance with the instructions, may cause harmful interference to radio communications. However, there is no guarantee that interference will not occur in a particular installation. If this equipment does cause harmful interference to radio or television reception, which can be determined by turning the equipment off and on, the user is encouraged to try to correct the interference by one or more of the following measures:

- Reorient or relocate the receiving antenna.
- Increase the separation between the equipment and receiver.
- Connect the equipment into an outlet on a circuit different from that to which the receiver is connected.
- Consult the dealer or an experienced radio/TV technician for help.



*Cable complying with the National authorities (cable with an outer jacket or sleeving rated VW-1 or better).



CONTENTS

ii	safety instructions	9	connecting and calibration
vi	table of contents	9	hook-up diagrams
1	system description	11	operating with firmware V5
2	hear back PRO hub	11	initial setup
2	hub detail diagram	11	mixer submix setup
2	hub features	12	additional button combinations
2	checking hub firmware version	12	channel linking via config file
3	hub I/O cards	13	technical specifications
4	hbus	14	troubleshooting and operating tips
4	input selector switch	16	system accessories
4	input metering	17	other hear technologies products
4	status indicating hub logo	17	limited warranty
4	internal fan		
4	dual power ports		
5	hear back PRO mixer		
5	mixer detail diagram		
5	mixer features		
5	checking mixer firmware version		
6	mixer construction		
6	status indicating mixer logo		
6	volume		
6	pan operation		
6	stereo link operation		
6	aux input		
6	preset operation		
7	intercom		
7	input signal display		
7	settings reset operation		
7	line outputs		
8	headphone amplifier		
8	pairing with a virtual mixer		
8	upgrading the mixer's firmware		



hear back PRO

This is it – the simplest, most affordable digital solution to get everyone the mix they need to perform their best. This new system platform is completely modular and infinitely expandable, which means it is **the last personal monitoring system you'll ever need.**

With this system, there is no learning curve. Whether or not you've ever used a personal monitor mixer, the simple layout of this powerful system makes getting the right mix a quick and effortless experience. Based in Gigabit Ethernet, this framework paves the way for an impressive range of future possibilities.

The Hear Back PRO System: Hub & Mixers

The Hear Back PRO system consists of two main components: the Hub and the Mixer. The modular Hub consists of four card slots, which can be populated with any configuration of input and/or output cards to fit your exact needs. Each Hub has the ability to supply signal and power to as many as 32 Mixers (8 per Network Card), each over a single standard CAT6* cable. And with the built-in HBUS In/Out ports, multiple Hubs can be daisy-chained together, allowing for truly unlimited system expansion.

The standard Hub (included in the Four Pack) comes pre-loaded with one Network Card and your choice of input card. For analog, two 8-channel Analog Input Cards are provided which can accept input signals from an audio mixer via auxiliary, matrix, monitor, and/or direct outputs. For digital options, you can choose from our Waves SoundGrid, Dante, ADAT, or AES/EBU Input/Output cards.

ADVANTAGES / FEATURES

- Side-mounted card slot on Mixer for future expansion
- Large master knob controls overall main mix, AUX, and intercom levels independently
- Volume and panning control of all channels
- Direct and immediate visual feedback of all channels
- Support for sampling rates up to 192 kHz
- Selectable XLR or 1/8" Mixer AUX input
- Built-in intercom broadcasts the AUX source (mic, MP3 player, click, etc.)
- Intercom auto adjusts its own level so even the quietest message never goes unheard
- Modular I/O Hub card system lets you customize the system to match your configuration, and can adapt to your needs
- Supports secondary power supply to provide redundancy and power to up to 32 Mixers per Hub Mainframe
- USB port on Hub makes updating firmware for future features and upgrades a simple drag-and-drop operation
- HBUS In/Out connections allow daisy-chaining Hubs and a wireless access point connection for use with the PRO's iOS App
- Status indicating logos on Hub and Mixers make it easy to detect and diagnose problems, should they arise
- Write session info and channel settings on storable Mixer overlays for an unlimited number of presets
 - Instantly store and recall presets from memory with the push of a button
 - Most recent configuration is saved, even after power-down
- Hear Back PRO iOS App allows for complete control of all Mixers connected to the network

*Cable complying with the National authorities (cable with an outer jacket or sleeving rated VW-1 or better).

HUB DETAIL DIAGRAM

FRONT PANEL

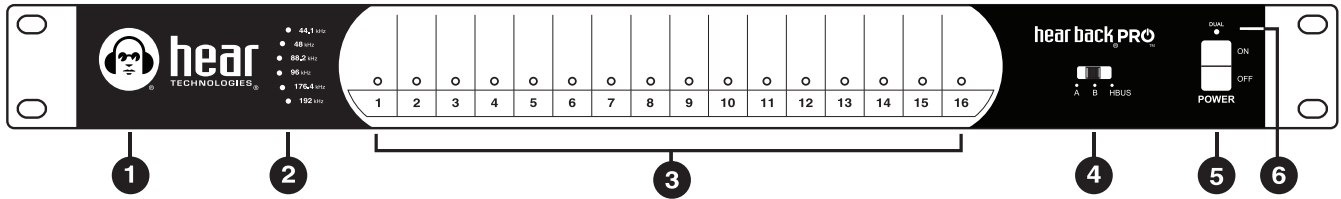

REAR PANEL

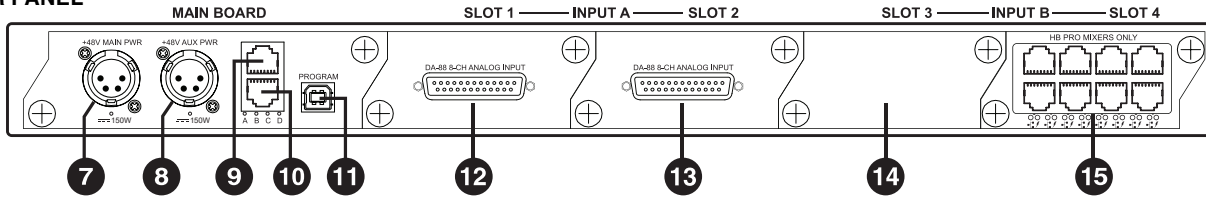

- | | | |
|--|-----------------------------|---|
| 1 LED Status Indicator | 7 Main 48V Power Input | 12 Card Slot 1 (8-channel Analog Input shown) |
| 2 Sample Rate LED Indicators | 8 Secondary 48V Power Input | 13 Card Slot 2 (8-channel Analog Input shown) |
| 3 Audio Input Channels 1-16 Level LED Metering | 9 HBUS Input | 14 Card Slot 3 (shown unpopulated) |
| 4 Input Selector Switch | 10 HBUS Output | 15 Card Slot 4 (8-port Network Card shown) |
| 5 Power Switch | 11 USB Connection | |
| 6 "Dual" Power LED Indicator | | |

HUB FEATURES

- Three switch selectable 16-channel input sources:
 - Input A (Slots 1 & 2)[†]
 - Input B (Slots 3 & 4)[†]
 - HBUS
- 24-bit Delta-Sigma A/D converters
- Six user-selectable sample rates, indicated by LEDs: 44.1 kHz, 48 kHz, 88.2 kHz, 96 kHz, 176.4 kHz, and 192 kHz
- Less than .25 milliseconds total system delay (latency) at 192 kHz
- 16 RGB LEDs intuitively display signal / peak levels for channel metering[‡]
- Standard CAT6* delivers power and signals to Mixers
- Daisy-chain via HBUS for very large systems
- Quiet, temperature-controlled fan (only runs when internal temperature reaches 43° C or 110° F)
- 1 RU chassis
- Modular I/O card-slot configurable mainframe
- Gigabit Ethernet network fabric, with enough bandwidth to support up to 96 channels of audio at 192/176.4 kHz, 128 channels at 96/88.2 kHz or 48/44.1 kHz.
- 48 volt Power Over Ethernet supply
- Port for redundant power supply (or to power more than 16 Mixers)
- USB port for firmware upgrades and future features
- Error indicating logo glows "red" should a fault arise

[†] For FW V5, both A and B inputs are used simultaneously. Switching between A and B only selects clock source.

[‡] For FW V5, the 16 metering LEDs can be selected to display channels 1-16 or 17-32 using the iOS App.

CHECKING HUB FIRMWARE (FW) VERSION

1. Apply Power.
2. Immediately after logo turns **BLUE**, slide the "Input Selector Switch" through all "A,B,HBUS" options, then return to the original selection (**Figure 1**).
3. Channel LEDs will flash **WHITE** to indicate firmware version – once for main number, then once for minor number (e.g. LED #2, then LED #9 = V2.9) (**Figure 2**).

NOTE: **Firmware Updates** are available for download at www.hearback.com/support/

FW V1 and V2 are not compatible with FW V5.
To upgrade or downgrade, visit www.hearback.com/fwv5

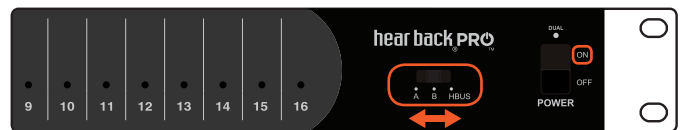

Figure 1

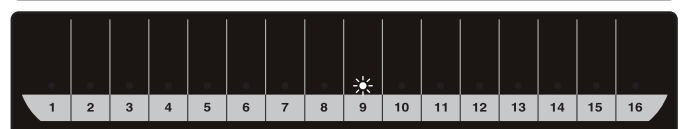
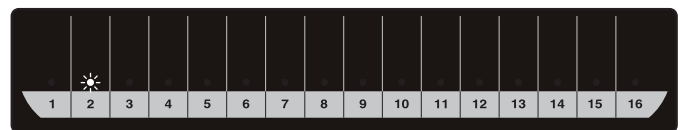

Figure 2

*Cable complying with the National authorities (cable with an outer jacket or sleeving rated VW-1 or better).

HUB I/O CARDS

The modular Hub consists of four card slots, which can be populated with any configuration of input and/or output cards to fit your needs.

ADAT CARD

Allows HBPRO Hub to communicate with audio equipment via ADAT protocol.

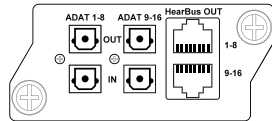

- Simultaneously sends and receives 16 channels of digital audio
- Backwards compatible with the OCTO and original 8-channel Hear Back systems
- (2) optical ADAT TOS-Link inputs, (2) optical ADAT TOS-Link outputs, and (2) RJ45 HearBus outputs (for connecting to the original Hear Back system)
- Supports and automatically locks on to sampling rates of 44.1kHz and 48kHz
- Automatic sampling rate down-conversion is applied on the ADAT and HearBus outputs when the system is running at sampling rates over 48kHz
- (2) cards can be populated per Hub to allow A/B input switching between (2) banks of 16 channels with FW V2 or 32 channels with FW V5
- Up to (4) cards can be populated to allow A/B input/clock switching as well as a second set of dedicated ADAT outputs

AES/EBU CARD

Allows HBPRO Hub to communicate with pro audio equipment using multi-channel AES/EBU protocol.

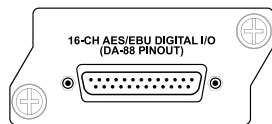

- Tascam DA-88-style pin-out on a DB-25 connector for inputting or outputting 16 channels of digital audio
- Jumper settings allow the user to choose whether the card is 16 inputs or 16 outputs
- Supports and automatically locks onto sampling rates of 44.1kHz, 48kHz, 88.2kHz, 96kHz, 176.4kHz, and 192kHz
- DB25 to (8) XLR (each AES/EBU XLR connector supports 2 channels of digital audio) break-out cable is sold separately, unless the AES/EBU card is purchased as part of the Hear Back PRO Four Pack
- (2) cards can be populated per Hub to allow A/B input switching between (2) banks of 16 channels with FW V2 or 32 channels with FW V5
- Up to (4) cards can be populated to allow A/B input/clock switching as well as dedicated AES/EBU outputs

DANTE CARD

Allows HBPRO Hub to communicate with any audio equipment using Dante protocol.

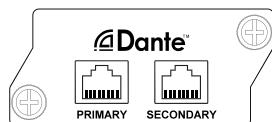

- Connects 16 channels of simultaneous audio input and output with other Dante-enabled equipment using a standard Ethernet network connection
- Supports sampling rates of 44.1kHz, 48kHz, 88.2kHz, 96kHz, 176.4kHz, and 192kHz
- (2) cards can be populated per Hub to allow A/B input switching between (2) banks of 16 channels with FW V2 or 32 channels with FW V5
- Up to (4) cards can be populated to allow A/B input/clock switching as well as a second set of dedicated Dante outputs

WAVES SOUNDGRID CARD

Allows HBPRO Hub to communicate with any pro audio equipment that uses Waves SoundGrid. Our partnership with Waves makes it easy to directly connect the Hear Back PRO system to other high-end audio equipment (including directly out of a PC or Mac using only its Ethernet port).

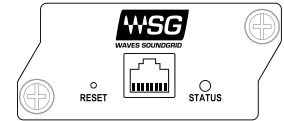

- Connects 16 channels of simultaneous audio input and output with other SoundGrid enabled equipment using a standard Ethernet network connection
- Supports sampling rates of 44.1kHz, 48kHz, 88.2kHz, and 96kHz
- (2) cards can be populated per Hub to allow A/B input/clock switching between (2) banks of 16 channels with FW V2 or 32 channels with FW V5
- Up to (4) cards can be populated to allow A/B input switching as well as a second set of dedicated SoundGrid outputs

ANALOG CARD

Allows HBPRO Hub to communicate with any professional analog audio equipment. Provides (8) balanced audio inputs using a standard Tascam DA-88-style pin-out on a DB25 connector. A DB25 to 1/4-inch TRS break-out cable is sold separately, unless the Analog input card is purchased as part of the Hear Back PRO Four Pack.

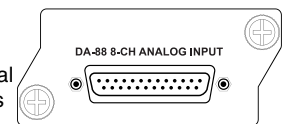

- -10dB pad on each channel allows the user to select +8dB or +18dB maximum input sensitivity level
- Custom input sensitivities available up to +34dB upon special request
- User configurable sampling rates of 44.1kHz, 48kHz, 88.2kHz, 96kHz, 176.4kHz, and 192kHz using jumpers
- (2) analog input cards are required to input 16 channels of audio
- Up to (4) cards can be populated per Hub to allow A/B input/clock switching between (2) banks of 16 channels with FW V2 or 32 channels with FW V5

NETWORK CARD

Provides (8) RJ45 Gigabit Ethernet ports for connecting Hear Back PRO Mixers, PRO Mixer Distros, or other Hear Back PRO Hubs.

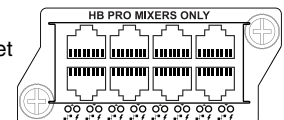

Each port provides PoE+ power and digital audio over a single CAT6 Ethernet cable that can be run up to 566 feet.

Up to (4) Network Cards can be populated per single PRO Hub. Also available as “stand alone” in the PRONET Mixer Distro Box.

VIRTUAL MIXER CARD

All the features of the HBPRO Mixer slimmed down into a card format. Control via the new Hear Back PRO iOS App or from another PRO Mixer. Features an auxiliary 1/8" Stereo Unbalanced Audio Input and XLR Balanced Left and Right outputs. Also works great for receiving or sending intercom audio in a studio control room.

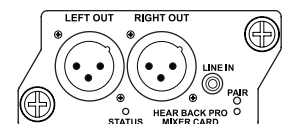

Quick Start User Guides for interface cards are available at www.hearback.com/support

*Cable complying with the National authorities (cable with an outer jacket or sleeving rated VW-1 or better).

HBUS

The HBUS permits daisy-chaining of multiple Hubs up to 500 feet apart using the HBUS input and HBUS output. This HBUS is great for inter-studio or stage-to-stage connections, as well as daisy-chaining for very large systems. Use Hear Technologies CAT6* cables available in 50 foot length.

HBUS In also allows a connection to a wireless access point for using the PRO's iOS App.

HBUS RJ45 pin-outs are the same as standard gigabit Ethernet RJ45 pin-outs, only without power. The pin-outs are wired as shown below:

Pin	Pair	Description	Suggested Termination Color Scheme (568B)****
1	A+	Bidirectional Data Pair A	white/orange
2	A-	Bidirectional Data Pair A	orange
3	B+	Bidirectional Data Pair B	white/green
4	C+	Bidirectional Data Pair C	blue
5	C-	Bidirectional Data Pair C	white/blue
6	B-	Bidirectional Data Pair B	green
7	D+	Bidirectional Data Pair D	white/brown
8	D-	Bidirectional Data Pair D	brown

****Color Scheme 568A is also acceptable, but do not crossover from 568A to 568B.

INPUT SELECTOR SWITCH

The input selector switch gives the user a simple way to select any one of the three input/clock sources without a patch bay, router, or rewiring.

For FW V2, switching between A and B selects 16 channels from either A or B.

For FW V5, inputs A and B are used simultaneously. Selecting between A and B only selects the clock source. If more than 32 channels are needed, multiple Hubs are required (see **Connecting Multiple Hubs** on page 11).

INPUT METERING

The Hub features a unique input metering circuit consisting of one RGB LED for each of the first 16 input channels. Each LED provides four visual levels that correspond color to signal strength in dBu:

Signal Strength	Color
-36 dBu to -18 dBu RMS	blue
-18 dBu to 0 dBu RMS	green
0 dBu to +17.5 dBu RMS	yellow
+17.5 dBu (clip) Peak	red

With FW V5, the optional PRO iOS App allows the user to select between monitoring channels 1-16 or 17-32.

STATUS INDICATING HUB LOGO

The illuminated logo serves as an indicator for several purposes. Under normal conditions, the logo will be **BLUE**, indicating valid clock is present (could be internal or external). A **RED** logo indicates no valid clock is present. If the logo is blinking **RED**, this typically indicates a temperature problem, but could indicate something else. Refer to troubleshooting section for detailed information.

INTERNAL FAN

The internal temperature-controlled fan operates whenever the internal temperature reaches 43° C or 110° F. In studio or indoor use, the fan should rarely come on. The Hub should be rack mounted away from high temperature devices such as power amplifiers. Please ensure our recommended clearances listed at the beginning of this manual are met.

DUAL POWER PORTS

The Hub supports two external power supplies. The second power supply serves two purposes: to provide redundancy in case of power failure, and to power more than two network cards (greater than 16 Mixers) in a single Hub. On the front of the Hub, an LED directly above the power switch will be lit if two power supplies are present. This provides an easy way to know if one of the power supplies has failed. On the back of the Hub, an LED is present directly under each power port, and will be lit if power is present at that port.

*Cable complying with the National authorities (cable with an outer jacket or sleeving rated VW-1 or better).

MIXER DETAIL DIAGRAM

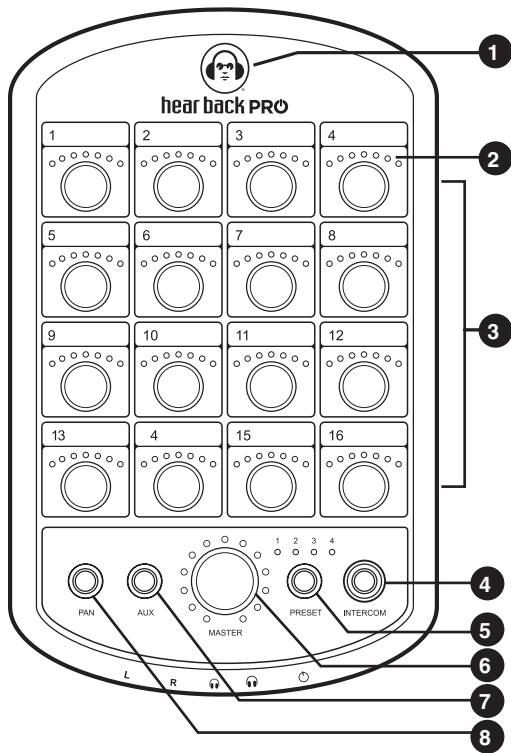

TOP PANEL

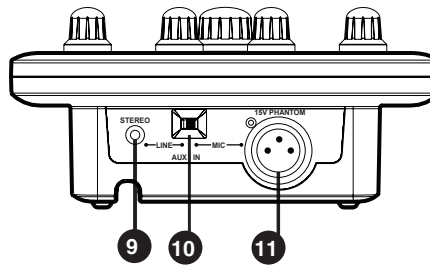

BOTTOM PANEL

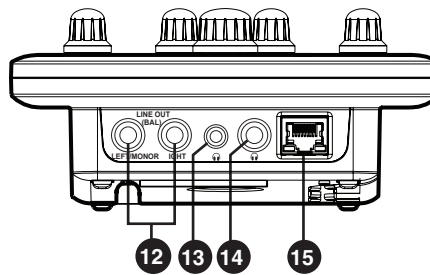

- 1 LED Status Indicator
- 2 LED Level Indicators
- 3 Volume/Pan Control Knob for Each Audio Channel
- 4 "Intercom" Button
- 5 "Preset" Button
- 6 "Master" Control Knob (Volume / Aux)
- 7 "Aux" Input Button
- 8 "Pan" Button
- 9 Auxiliary 1/8" Stereo Unbalanced Audio Input
- 10 Auxiliary Input Switch
- 11 Auxiliary Balanced XLR Microphone Input with 15V Phantom Power
- 12 1/4" Left/Mono and Right Outputs
- 13 1/8" TRS Headphone Output
- 14 1/4" TRS Headphone Output
- 15 Gigabit Ethernet (GbE) Connection with PoE+ (Power over Ethernet)

MIXER FEATURES

- Local control of all available audio channels
- Receive power and audio over one Ethernet cable, up to 500' from Hub to each Mixer
- Side-mounted card slot for future expansion
- Large master knob controls overall main mix, AUX, and intercom levels independently
- 24-bit D/A and A/D delta-sigma converters
- Error indicating logo glows "red" to indicate a problem, and flashes "red" when headphone amplifier temperature reaches 100° C (212° F)
- Volume / panning / stereo link control of all channels of audio
- Balanced mono/stereo, line level outputs
- Store up to 4 recallable presets, while most recent configuration is remembered after power-down
- Intercom feature allows communication to anyone with a Hear Back PRO Mixer or Virtual Mixer Card
- Selectable 1/8 inch TRS stereo unbalanced and XLR mono balanced (with 15V phantom power) AUX inputs:
 - Microphone input for crowd/ambience mic, or for use with intercom
 - Drum module/metronome or local mix input
- One 1/8 inch TRS headphone output
- One 1/4 inch TRS headphone output

CHECKING MIXER FIRMWARE (FW) VERSION

1. Starting with power "off", press and hold **PRESET** button while inserting network cable to apply power (until buttons flash) (**Figure 3**).
2. The LED that is lit around the MASTER knob shows the major firmware version. The channel knob lit with **BLUE** LEDs indicates the minor firmware version 1-16. With lit **GREEN** LEDs, the minor firmware version is channel number + 16 = 17-32.
 - Example: If the first LED is lit around the MASTER knob and the LEDs above the channel 7 knob are lit **BLUE**, the firmware version is 1.7 (**Figure 4**).
 - To display the bootloader version number, press the **PAN** button. The version number is display in the same way.
3. To EXIT, disconnect then reconnect power.

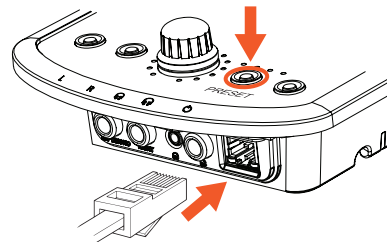

Figure 3



Figure 4

Firmware updates for the Mixer are done using the iOS App. Alternatively, they can be done using a **Firmware Update Card** (see page 8).

*Cable complying with the National authorities (cable with an outer jacket or sleeving rated VW-1 or better).

MIXER CONSTRUCTION

The Hear Back PRO is constructed of UV-stabilized ABS and has a built-in mic stand mount. The cable strain relief channel (molded into the Mixer) greatly reduces stress on the CAT6* cable connectors and the Mixer RJ45 connector.

STATUS INDICATING MIXER LOGO

The illuminated logo serves as an indicator for several purposes. Under normal conditions, the logo will be **BLUE**, indicating digital audio packets are being received. A **PURPLE** logo indicates audio packets are being dropped, and a **RED** logo indicates no valid packets are being received. If the logo is blinking **RED**, this indicates the headphone amplifier has overheated. Check the troubleshooting section if any color other than a **BLUE** logo occurs.

VOLUME

Each channel knob controls the volume of its respective channel(s) within the mix. The master knob, by default, controls the volume of the overall mix. Volume operation is indicated by **BLUE** LEDs. Volume scales from 0% to 100%, left to right, respectively.

MASTER VOLUME

The master volume is used to set the volume of the headphones and the line outputs. When using the line outputs in conjunction with the headphones, optimize the mix for the headphones and then adjust the device connected to the line outputs to balance the gain.

PAN OPERATION

To control panning of channels, press the **PAN** button. The **PAN** button and channel knob LEDs will turn **GREEN** to indicate that the channel knobs now control panning position of the audio within the stereo field. To return to volume control, press the **PAN** button again, or wait 30 seconds from the last adjustment for the system to automatically return to volume control.

With FW V5, pressing **PAN** while in volume mode will show **PAN** (**GREEN** LEDs) and pressing again will show width controls for channels that are stereo.

STEREO LINK OPERATION

Each audio channel comes from a mono source, and is therefore center-panned by default for FW V1. To quickly hard-pan two channels left and right to create a stereo pair:

- Press and hold **PAN** for two seconds to enter linking mode.
- Channel LEDs will flash **GREEN**. Twist one of two adjacent channel knobs (1-2, 3-4, 5-6, etc.) to link them. Channel LEDs will illuminate **AQUA** when stereo linked. To unlink channels, twist one of the linked knobs.
- To EXIT, press **PAN** button or wait 30 seconds to go back to default volume levels.

This operation can only be performed on adjacent pairs of channels. Therefore, channel 1 can only be linked with channel 2, channel 3 with channel 4, and so on. Upon linking channels, the volume of the right channel is set according to the volume of the left channel. Volume adjustments to either stereo-linked channel now effects both channels in unison.

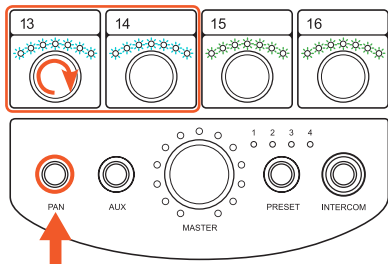

With FW V1, the link affects only the Mixer you are adjusting. Linking is Mixer specific. With FW V2, Stereo Linking is the same as previously stated, but stereo placement and width are added.

With FW V5, linking is global for all Mixers (see **Channel Linking Mode** on page 12).

AUX INPUT OPERATION

The auxiliary input connections provided are one 1/8 inch TRS stereo unbalanced input optimized for 0 dBu input level, and one XLR mono balanced input optimized for -42 dBu input level, selectable via the switch located adjacent to the connections. The inputs provide another mono or stereo-mixed channel to be inserted into the Mixer. Examples of use would be a drum machine click track into the drummer's Mixer, or a crowd/ambient mic in everyone's Mixer (which can double as the intercom mic). Another application would be a stereo mix from a guitar or keyboard local mix from another Hear Back or Hear Back PRO Mixer, creating a total of 18 channels controlled from your Mixer.

- Press the **AUX** button to change the function of the master knob to control the volume of the auxiliary input in the mix.
- **AUX** button and master knob LEDs will turn **RED** to indicate this function is active.

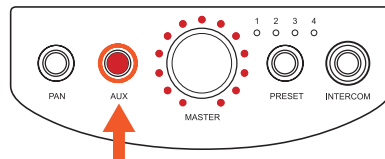

- Press the **AUX** button again to exit auxiliary volume control, or wait 30 seconds from the last adjustment for the system to automatically return the master knob to its default function.

PRESET OPERATION

The Hear Back PRO Mixer has the ability to store up to four system states in internal memory for easy session settings recall. Pressing the **PRESET** button will step through presets 1 – 4, one at a time.

SAVE A PRESET:

- Press and hold **PRESET** for two seconds. The current preset LED will begin flashing quickly.

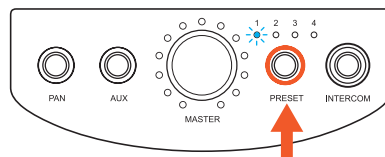

- Keep holding if you wish to save to a different location (unit will scan across the four preset locations).
- To EXIT, let go of the **PRESET** button.

Upon making any control change while using a preset, the preset number will slowly blink to let you know your new settings have not been saved. To save the changes to the preset, simply hold the **PRESET** button for 2 seconds until the preset number rapidly blink, then release.

To reset a preset's parameters back to default (all volume at 0%, all channels center-panned, all stereo-linked channels unlinked), first complete the settings reset operation (discussed later in this manual), then complete the normal steps listed above to save the settings to a preset. For FW V2 and V5, changing presets will automatically store the changes made before the preset increments.

*Cable complying with the National authorities (cable with an outer jacket or sleeving rated VW-1 or better).

PRESET COPY AND PASTE (TO ANOTHER Mixer)

- Press and hold **PRESET** (one of the Preset LEDs will flash), then while holding **PRESET** press the **INTERCOM** button.
- All four of the preset LEDs will flash quickly indicating that the Mixer is in “copy” mode.
- Release buttons.

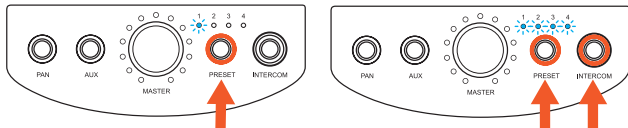

- To “paste” the settings from this Mixer to another Mixer:
 - Go to the Mixer that you wish to paste the settings to and press **PRESET** and **INTERCOM** at the same time.
 - All the LEDs will flash indicating that the settings were copied.
 - *Note: This does not copy all the presets, ONLY the current audio levels and pan settings for FW V1/V2 and routing and submixing for FW V5.*
 - The Mixer you’re copying from will continue to stay in “copy” mode for up to 5 minutes, allowing you to “paste” the settings to other Mixers.
 - To EXIT the “copy” mode, press **PRESET** button, or wait for the timeout.

INTERCOM OPERATION

The intercom function transmits the AUX IN source to everyone with a Hear Back PRO Mixer on the same network. By default, the input gain for the intercom source is set to 75%. When receiving audio from another Mixer, the intercom has an auto gain feature that automatically adjusts the incoming signal so that you’ll always hear it over your mix.

To broadcast your intercom momentarily, simply press and hold the **INTERCOM** button. The button and the master knob LEDs will light up **RED** to indicate that the intercom is broadcasting, and that the master knob now controls the input gain for your intercom source.

ENABLE/DISABLE INTERCOM:

- Starting with power “off”, press and hold **INTERCOM** button while inserting the network cable to apply power.
- Continue pressing **INTERCOM** until buttons start flashing, then release.
- Toggle the intercom function by pressing **INTERCOM** button. LED “on” is intercom enabled; LED “off” is intercom disabled.
- To **SAVE** and **EXIT**, disconnect then reconnect power.

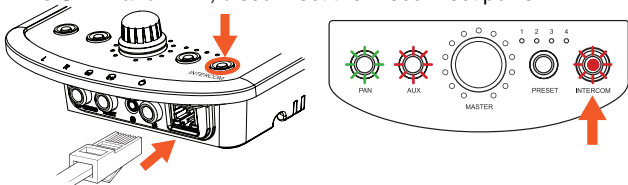

For FW V1, to latch your intercom for a continuous broadcast, rapidly push the **INTERCOM** button three times in succession. The button and the master knob LEDs will stay **RED** to indicate that the intercom is broadcasting. Press the **INTERCOM** button once more to stop continuous broadcast and return the master knob to its original function. The **INTERCOM** button will rapidly blink **RED** to indicate that a broadcast from another Hear Back PRO is currently being received. Only one Mixer is able to broadcast at a time, so while one Mixer is broadcasting, all other Mixers on the same network are “locked out” from broadcasting until the transmitting Mixer’s **INTERCOM** button is released or un-latched. If another Mixer is broadcasting and you wish to overtake the intercom, simply triple-tapping the **INTERCOM**

button will stop the other Mixer from transmitting, latching your intercom instead.

For FW V2 and V5, quickly touching and releasing the button will latch the **INTERCOM**, as will a triple-tap. With FW V2 and V5, up to four Mixers can be latched at the same time to carry on a conversation – all other functions are like V1.

INPUT SIGNAL DISPLAY

For FW V1 and V2, press and hold the **AUX** button until it starts blinking to easily see which channels have signal present without having to turn up each channel individually. If a signal is detected on a channel, the channel’s LEDs will light up. Additionally, the master knob’s LEDs act as an overall RMS meter, showing you how much headroom is available. This makes it easy to see how close the Mixer is to clipping. Note that you are still able to adjust channel and master volume in this mode; however, the level indicator will only be shown briefly after making an adjustment, before returning to displaying input signal activity.

- Press and hold **AUX** for 2 seconds until **AUX** button starts flashing.
- LEDs above each channel blink to show audio signal is present.

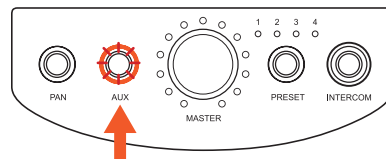

- A level meter is displayed using LEDs around the MASTER knob to show the current RMS level of the mix bus.
- To EXIT, press **AUX** button.

NOTE: For FW V5, the signal display works ONLY in 128-channel mode (see page 11).

INITIALIZE DESKTOP (RESET TO DEFAULT)

For FW V1 and V2, initializing the Mixer desktop will quickly reset all volume to 0%, unlink all stereo-linked channels, and move any panning back to center position.

- Press **PAN** and **AUX** at same time for 2 seconds until all LEDs flash to reset all levels to defaults (all volumes to zero and PANS to center).

Note: This will not wipe any existing preset settings.

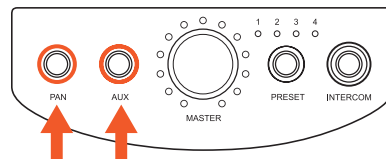

For FW V5, initializing the Mixer desktop will set all volume levels to zero, panning back to center, and one-to-one routing on all the channels (i.e. input 1 to knob 1, input 2 to knob 2, etc.). However links will remain in place as the linking function is global over all the Mixers.

LINE OUTPUTS

Two balanced 1/4 inch TRS line outputs are provided. The left operates as a mono output for sub woofers and mono devices if nothing is plugged into the right line output. When a 1/4 inch plug is inserted into the right output, the line outputs operate in a normal stereo mode. The line outputs may be used simultaneously with the headphone outputs, and are both controlled with the master volume knob. In the event of ground loops when connecting the Mixer line outputs to other devices that have an earth ground, it may become necessary to lift the shield at the Mixer outputs.

⚠ NEVER lift or disconnect the AC safety ground of any device.

*Cable complying with the National authorities (cable with an outer jacket or sleeving rated VW-1 or better).

HEADPHONE AMPLIFIER

The headphone amplifier outputs are paralleled outputs. When using multiple headsets, the total impedance should not go below 16 ohms. The headphone amplifiers are very powerful and can easily damage in-ear transducers, headphones, and your hearing; exercise great care in adjusting the master volume. At 32 ohms, the amplifier is capable of sustaining 2 watts of power per ear! The amplifiers are short circuit protected, and will cause the status indicator logo to blink **RED** if overheated.

PAIRING WITH A VIRTUAL MIXER

For FW V2 and V5 only, a Virtual Mixer Card can be paired with a PRO Mixer allowing control of all the audio channels with presets and intercom. Pairing can also be done via the iOS App.

- On the Virtual Mixer card, hold the **PAIR** button until the LED begins blinking rapidly.
- After a few seconds, the LED will blink about once a second. Once this happens, press **AUX** and **PRESET** on the Hear Back PRO Mixer you wish to pair with the Virtual Mixer.
- All the LEDs will blink indicating that it is now paired.
- To UNPAIR, hold the **AUX** and **PRESET** buttons on the Mixer that is currently paired with the Virtual Mixer and then turn the MASTER knob. All the LEDs around the MASTER knob will light up, indicating the Mixer is NOT paired. After a few seconds, the LED on the Virtual Mixer card will not be lit.

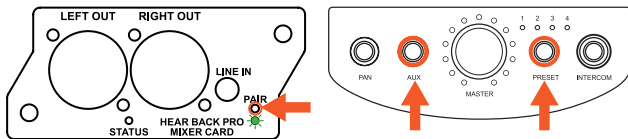

FOOTSWITCH OPERATION

If using the PRO Intercom Footswitch, it mutes the microphone signal going to the sound board without any pops or clicks. The microphone signal is then routed to the Hear Back PRO Mixer along with a special 22kHz signal that automatically engages the intercom feature on the Mixer (firmware V1.3 or higher). The 22kHz signal is not only above the human hearing range, it is also at a very low level – just enough for the Hear Back PRO Mixer to detect.

ENABLE/DISABLE FOOTSWITCH:

This setting can also be modified via the iOS App.

- Starting with power “off”, press and hold **INTERCOM** button while inserting the network cable to apply power.
- Continue pressing **INTERCOM** until buttons start flashing, then release.
- Toggle the footswitch function by pressing the **AUX** button. LED “on” is footswitch enabled; LED “off” is footswitch disabled.
- To SAVE and EXIT, disconnect then reconnect power.
- *Note: The intercom must be enabled before you can enable the footswitch function.*

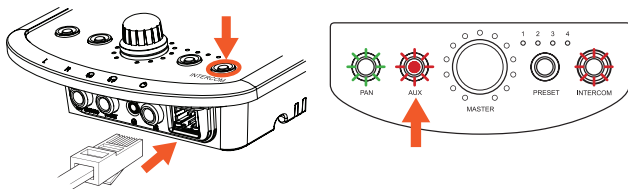

UPGRADING THE MIXER'S FIRMWARE

If your current Mixer firmware is below V2.14, call or email us to request a Firmware Update Card.

Tel: +1 (256) 922-1200 ext .135

Email: support@HearTechnologies.com

UPGRADING WITH THE FIRMWARE UPDATE CARD

1. Unplug the network cable so the Mixer is powered down.
2. Turn the Mixer upside down and remove the two screws that secure the expansion card cover as shown (set aside the two screws and expansion card cover).
3. Insert the Hear Back PRO Mixer **Firmware Update Card** into the expansion slot as shown. Notice the “UP” printed on one side of the card. This should be facing the same direction as the top of the mixer.
4. After the card is inserted, connect a network cable from the Mixer to either a Hear Back PRO Hub or Mixer Distro that is powered on. The Mixer should power on and begin the update process (this takes a couple of minutes to complete).
5. As the firmware updates, the LEDs will illuminate **GREEN** one-by-one to indicate the progress of programming the new firmware into the Mixer's memory. Next, the LEDs around the master knob will illuminate **PURPLE** one-by-one to indicate the progress of upgrading the user interface – the final step in the process.
6. Once all of the master LEDs are illuminated **PURPLE**, wait 30 seconds. It will reboot once it is finished.

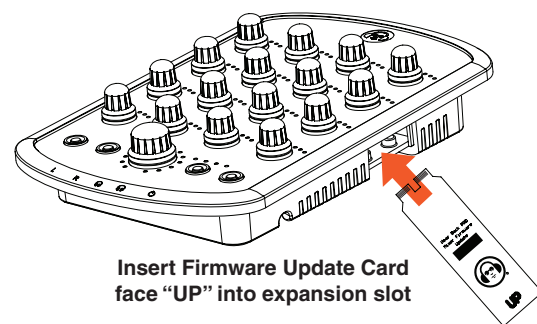
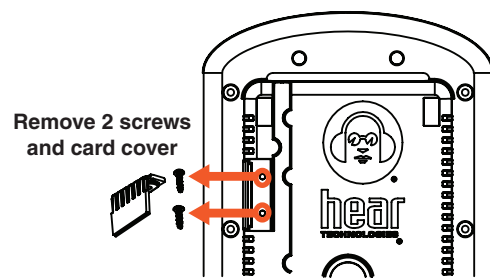

CONNECTING AND CALIBRATION

- 1. Connect the appropriate input(s)**, as shown in the hook-up diagram below and select the desired input using the front panel switch. Connect Hear Back PRO Mixers to the network card outputs using CAT6* cables and set all Mixer channel and master volume levels to 0%. Connect the headphones, in-ear monitors, and/or line outputs for connecting to wireless in-ear systems, powered monitors, or other devices requiring line-level inputs.
- 2. Turn on Hub power.**
- 3. Adjust the level at the input source** (DAW, mixer, etc) until the **RED** clip LED's on the Hub just come on and then reduce the levels on the input source until you have a **GREEN** LED. **NOTE:** Adjust the source for as much signal into the Hub as possible without clipping. Higher input levels improve signal-to-noise and dynamic range. If you are unable to adjust your source without overdriving the Hear Back PRO system, follow the “-10dB Pad” instructions on page 2 to achieve an extra 10dB of headroom. Remember, higher input levels improve signal-to-noise and dynamic range.
- 4. Mixer Adjustment:** Once you have the signals optimized, turn the master volume up to about 10 o'clock and then raise each channel's volume up to a comfortable level. Avoid adjusting the master volume too high and running the inputs too low. If you wish to stereo-link any channels, enter the stereo-link control interface and toggle them on. If you wish to pan any mono channels within the stereo field, press the **PAN** button to make adjustments.
- 5. AUX IN Adjustment:** If using an auxiliary input, connect it to the Mixer via the appropriate “LINE” or “MIC” input. Select the appropriate input via the “AUX IN” selector switch. If possible, adjust the input source for maximum volume without clipping. Press the “**AUX**” button to turn the “Master” knob LEDs **RED** and slowly turn the “Master” knob to a comfortable level. Press the “**AUX**” button again to exit auxiliary volume control.

Now enjoy personal monitoring at its best and have fun!

⚠ WARNING

- The Hear Back PRO is capable of driving most headphones to extreme levels that can damage your HEARING!
- ALWAYS turn down the Mixer “Master” volume down before putting on in-ear headsets or headphones.

HOOK-UP DIAGRAM | ANALOG (FW V1 AND V2)

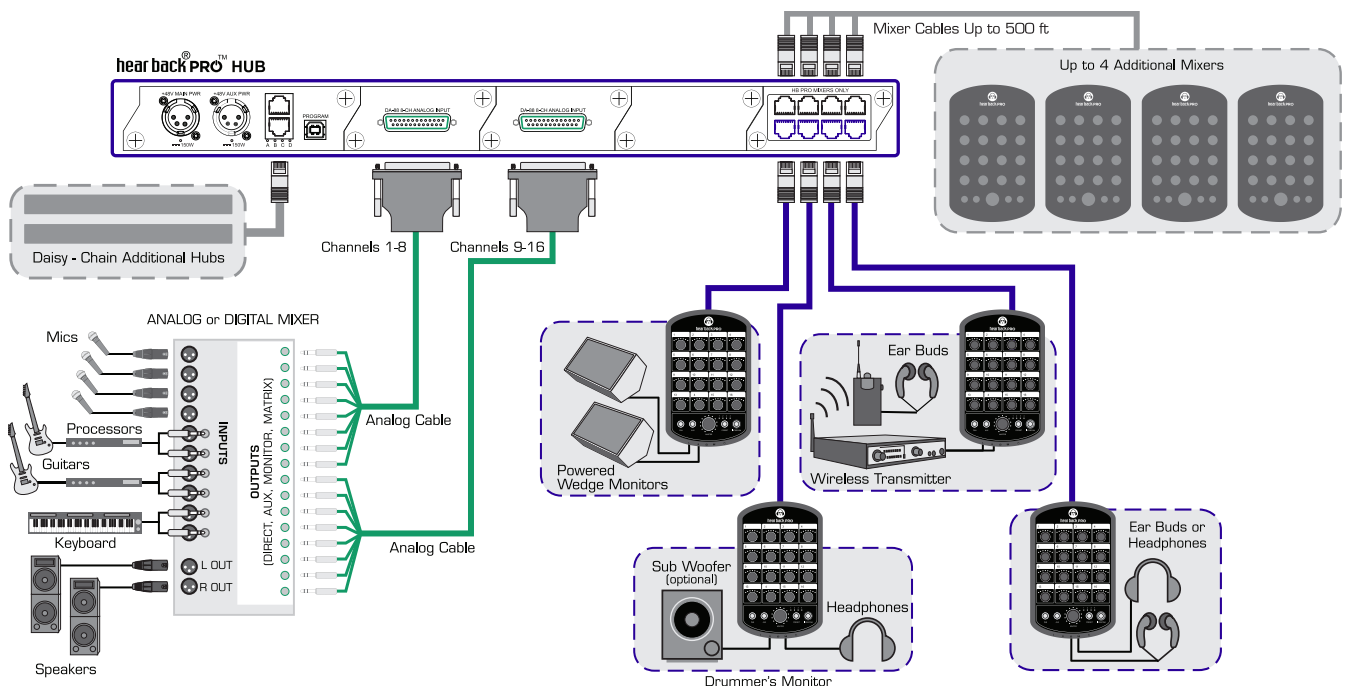

*Cable complying with the National authorities (cable with an outer jacket or sleeving rated VW-1 or better).

HOOK-UP DIAGRAM | DIGITAL (FW V5)

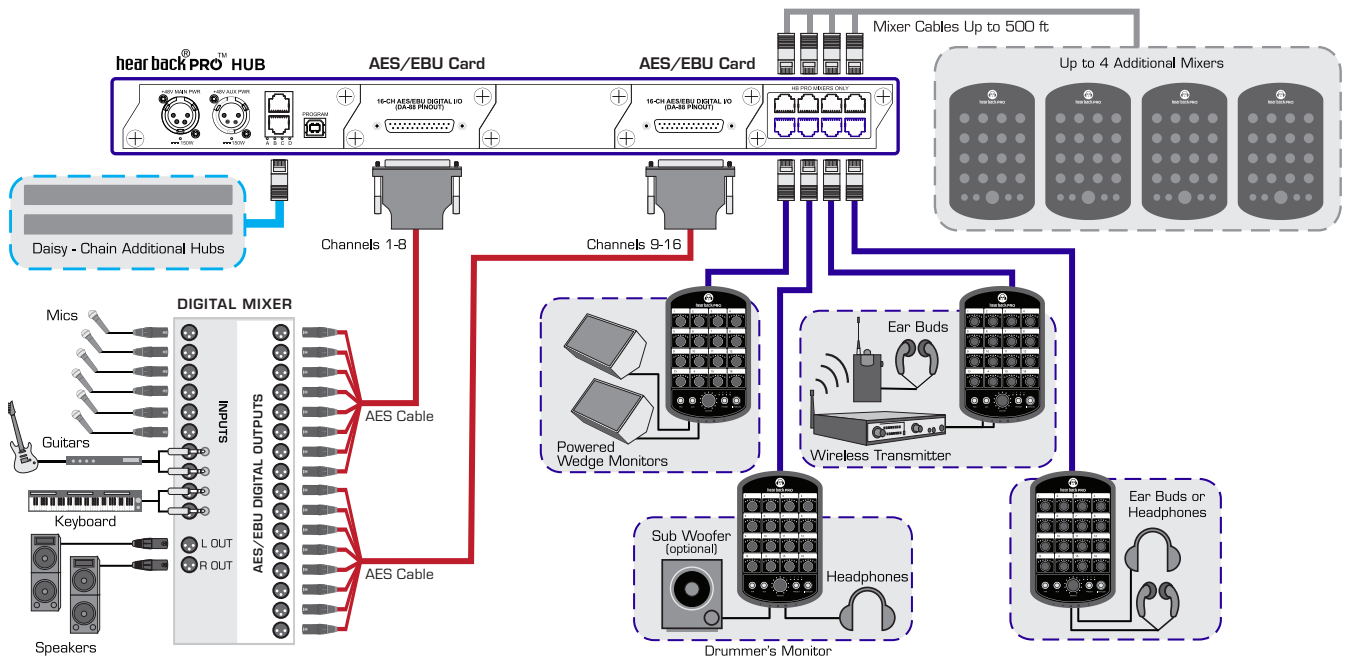

HOOK-UP DIAGRAM | SIMULTANEOUS DIGITAL AND ANALOG (FW V5)

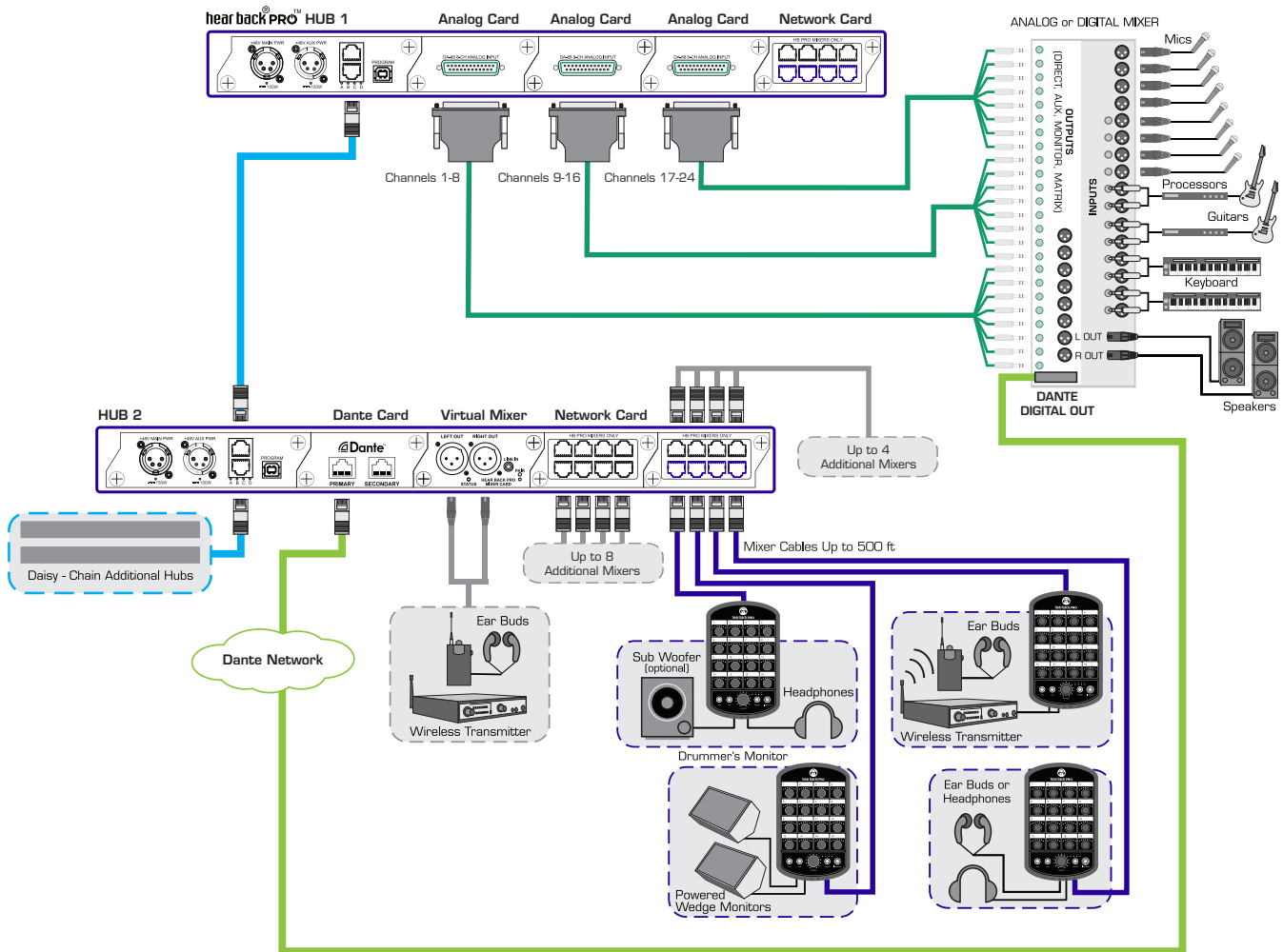

OPERATING WITH FIRMWARE (FW) V5

INITIAL SETUP

If you are using from 1 to 32 channels you will only need one Hear Back PRO Hub. If you are using 33 channels or greater you will need multiple Hubs.

CHANNEL LOCATIONS:

- Hub 1 – Channels 1-32
- Hub 2 – Channels 33-64
- Hub 3 – Channels 65-96
- Hub 4 – Channels 97-128

Example: An engineer needs to send out up to 64 channels of analog audio to its personal monitoring system. They would need the following hardware:

- 2 x Hear Back PRO Hubs
- 8 x Hear Back PRO Analog Input Cards (4 in each Hub)

Each Hear Back PRO Analog Input Card supports 8 channels of audio. Each Hub will then support up to 32 channels (4 x 8 = 32) giving the engineer a total of 64 channels.

CONNECTING MULTIPLE HUBS

Note: Use only unshielded CAT5e or CAT6 Ethernet cables

1. Connect Hub 1 **HBUS OUT** to Hub 2 **HBUS IN**
2. Connect Hub 2 **HBUS OUT** to Hub 3 **HBUS IN**
3. Connect Hub 3 **HBUS OUT** to Hub 4 **HBUS IN**

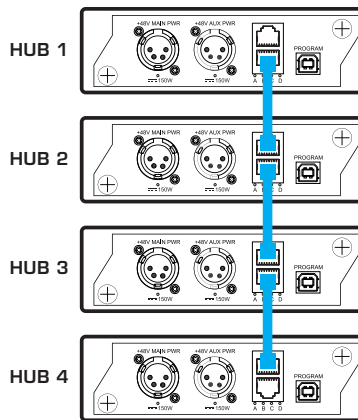

INPUT SELECTOR SWITCH

The Input Selector switch is located on the front panel of the Hear Back PRO Hub. This switch is now used to select which card slot the clock source comes from.

- Select either A or B for Internal Clock Source
- Select HBUS for Mixer expansion (additional Network Cards added to Hub)

*Note: All Hubs need to set to the same sampling rate. If there's a mix of input cards (analog and digital) the digital card must be the **CLOCK MASTER**, and then the analog will **SLAVE** to it. If there are multiple digital cards - the digital audio must all come from the same source and be word-clock synchronized or there will be pops and clicks in the audio.*

HUB POSITION INDICATOR

A Hub's position (Hub number) can be seen when powering ON Hubs or by switching between sources (A, B, or HBUS). The LEDs on the Hub's front panel will light up either **WHITE** or **BLUE**. The **WHITE** LED indicates what the Hub's position is in the Hub chain (i.e. if LED 2 is **WHITE** then that Hub is Hub 2 in that Hub chain).

128-CHANNEL MODE

Note: 128-Channel Mode is intended for diagnostics and configuration. When you exit 128-Channel Mode, your settings are lost. If you choose to keep your settings, don't exit 128-Channel Mode. Submixing is not possible in 128-channel mode.

- Press and hold **PRESET** and spin the **MASTER** knob
- Selected preset LED will then flash **ONCE** per second and the other preset LEDs will light up dimly showing the other Hubs that are connected:

1 Hub connected: Presets 1 and 2 will illuminate (indicates BANK 1 and 2 are available)

2 Hubs connected: Presets 1-4 will illuminate (indicates BANKs 1 through 4 are available)

3 Hubs connected: Once you press **PRESET** to cycle through the BANKS (Presets 1-4), you will return to Preset 1 but will now be flashing **TWICE** per second, indicating you are in BANK 5. Continuing to press **PRESET** will advance you to BANK 6 (Preset 2), then BANK 7 (Preset 3) and then BANK 8 (Preset 4), with BANKs 5-8 LEDs flashing **TWICE** a second.

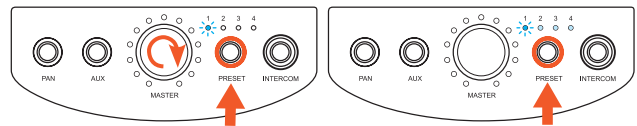

- You have access to all available channels in a one-to-one mapping.
- Step through the BANKs of channels (denoted by the Presets) by selecting a Preset (example: If Preset 1 and 2 are lit, then you have 32 channels to select from).

PRESET 1	Single Flash	BANK 1	Channels 1-16
PRESET 2	Single Flash	BANK 2	Channels 17-32
PRESET 3	Single Flash	BANK 3	Channels 33-48
PRESET 4	Single Flash	BANK 4	Channels 49-64
PRESET 1	Double Flash	BANK 5	Channels 65-80
PRESET 2	Double Flash	BANK 6	Channels 81-96
PRESET 3	Double Flash	BANK 7	Channels 97-112
PRESET 4	Double Flash	BANK 8	Channels 113-128

- Press and hold **PRESET** to exit back to 16-channel mode.

SUBMIX EDIT MODE (WITHOUT USING THE iOS APP)

Submixes are 2 or more channels assigned to a single knob. Use this mode to choose what channels are going to a specific knob.

- To enter Submix Mode, press and hold **PRESET** then spin the channel knob that you're wanting to edit its submix or channel assignment. LEDs will blink once. Release **PRESET**.

Example: Channel one sent to Knob 15 – Knob 15 LEDs are lit. This indicates channel one is routed to Knob 15.

- Step through various BANKs by pressing the **PRESET** button.

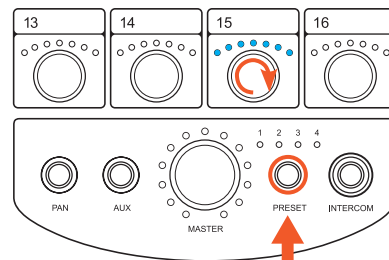

- Select and edit channels (channels can be turned on or off). A channel with no LEDs ON indicates the channel is OFF or not assigned. A channel with all LEDs ON indicates it is the only channel (or stereo pair) assigned to the submix. If only one channel (or stereo pair) is assigned, then adjusting volume, Pan, and width is disabled. If you turn up 2 or more knobs while editing, they will each display the respective levels. Adjust each level to balance the mix of channels. You can also adjust PAN and WIDTH (for stereo pairs only) if 2 or more channels are selected. Up to 16 channels can be assigned to a single knob.
- The Preset LEDs indicate the BANK of inputs currently selected (as described previously for 128-channel mode).
Example: If Preset 1 LED is flashing (single flash) and Preset 2 LED is on, this would indicate that you are in BANK 1 of 2. If both Preset 3 and 4 were also ON, that would indicate you are in BANK 1 of 4.
- To save press and hold **PRESET** for 2 seconds. All LEDs will flash, then the preset LEDs will go back to indicating only what preset the Mixer is presently on.

ADDITIONAL BUTTON COMBINATIONS

PAN, WIDTH AND VOLUME CONTROLS

- Press **PAN** once to access Pan Controls (LEDs turn **GREEN**).

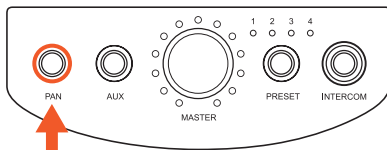

- Press **PAN** twice to access Width Controls (LEDs turn **AQUA**).
Note: WIDTH is ONLY available on stereo channels and submixes. Single mono channels do not have width control.
- Press **PAN** to return to Volume Controls (LEDs turn **BLUE**).

CHANNEL LINKING MODE

This can only be done from the standard 16-knob mode if everything is one-to-one channel mapped. Otherwise channel linking must be accessed in 128-Channel Mode (see previous information on 128-Channel Mode). Channel linking can also be adjusted via the iOS App.

- Press and hold **PAN** for 2 seconds.
- Channel LEDs flash **GREEN**.
- Turn channel knob you want to stereo link (*Note: adjacent knobs link. Example 1-2, 3-4, etc.*).
- Press **PAN** to exit.

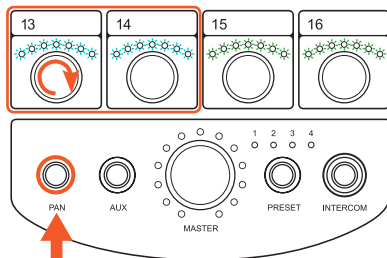

Note: Linking is saved on the Hub and is global to all Mixers.

ZERO OUT MIXER

Zeros volume, pan and width, and sets one-to-one routing on all the channels (i.e. input 1 goes to knob 1, input 2 goes to knob 2, etc.) on whatever PRESET that is selected (does not affect any other presets).

- Press and hold **PAN** and **AUX** until all the LEDs flash twice.

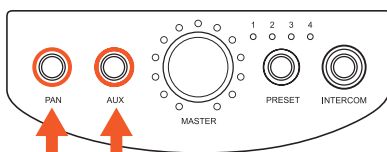

CHANNEL LINKING VIA CONFIG FILE

EDIT CONFIG.TXT FILE

Each Hear Back PRO Hub has its own editable CONFIG.TXT file. To access, follow the steps below:

1. Plug USB (B-Male) into the PROGRAM connector in the back of the PRO Hub
2. Connect USB (A-Male) to computer
3. Hub will show up as a DRIVE (i.e. HBPRO on D Drive)
4. Open folder
5. Open CONFIG.TXT

The CONFIG.TXT file contains the following information:

- Header information and comments (##)
- Clock Settings:
INTERNAL - Internal clock (Default)
EXTERNAL - Word Clock card (use only if you have a Hear Back PRO Word-Clock Card installed)
- Channel Link Settings
STEREO – Adjacent channels are stereo linked
MONO – Channels are mono

EDIT CHANNEL SETTINGS

To change the channel settings type (not case sensitive) either

- STEREO or MONO (S or M – shorthand can also be used)
- Save CONFIG.TXT file

CHANNEL LOCATIONS

- Hub 1 – Channels 1-32
- Hub 2 – Channels 33-64
- Hub 3 – Channels 65-96
- Hub 4 – Channels 97-128

RETURN HUB TO FACTORY DEFAULT

- Delete CONFIG.TXT file
- Power OFF Hub
- Power ON Hub
- CONFIG.TXT file is now set back to factory default settings

SAMPLE “CONFIG.TXT” FILE

```
## Hear Technologies Configuration File v2.0
## Clock Configuration
## Choose External if Word Clock Card
## is installed in a slot
## For external clock: Input A = External
## For internal clock: Input A = Internal
##
## Stereo Channel Link Configuration
## For mono channels: CHANNEL 1&2 = MONO
## For stereo channels: CHANNEL 1&2 = STEREO
## Valid channels are 1 though 32
```

```
Input A = Internal
Input B = Internal
CHANNEL 1 & 2 = STEREO
CHANNEL 3 & 4 = MONO
CHANNEL 5 & 6 = STEREO
CHANNEL 7 & 8 = STEREO
CHANNEL 9 & 10 = MONO
CHANNEL 11 & 12 = MONO
CHANNEL 13 & 14 = MONO
CHANNEL 15 & 16 = MONO
CHANNEL 17 & 18 = MONO
CHANNEL 19 & 20 = MONO
CHANNEL 21 & 22 = MONO
CHANNEL 23 & 24 = MONO
CHANNEL 25 & 26 = MONO
CHANNEL 27 & 28 = MONO
CHANNEL 29 & 30 = MONO
CHANNEL 31 & 32 = MONO
```

TECHNICAL SPECIFICATIONS

Mixer Aux Input

Line Input Configuration/Impedance:	1/8" Stereo, unbalanced, 10K ohms typical
Line Input Level:	0 dBu optimal, +18 dBu max
Mic Input Configuration/Impedance:	XLR Mono, balanced, 150 ohms typical, 150 Hz high pass
Mic Input Level:	-42 dBu optimal, -30 dBu max

Mixer Headphone Power

Load Impedance:	THD less than 0.01%*	THD less than 0.1%
8 Ohms:	1.2 W*	1.5 W
	*THD AT 8 Ohms = 0.015% typical	
16 Ohms:	1.6 W	1.8 W
25 Ohms:	2.0 W	2.2 W
32 Ohms:	1.8 W	2.0 W
50 Ohms:	1.5 W	1.6 W
100 Ohms:	1.1 W	1.2 W
200 Ohms:	500 mW	650 mW
600 Ohms:	220 mW	250 mW
Inter Modulation Distortion:	Typically less than 0.03%	

Mixer Line Output

Frequency Response:	20 Hz to 20 kHz, +/-0.15 dBu
THD+N:	0.004% typical at 1 kHz, +15 dBu
Inter Modulation Distortion:	0.008% typical, 20 Hz – 20 kHz, +4 dBu 0.02% typical at +4 dBu, 60 Hz/7 kHz
Crosstalk:	Less than -93 dBu @ 1 kHz
Propagation Delay:	
Analog Input to Analog Output:	0.248 mSec @ 192 kHz sample rate
Digital Input to Analog Output:	0.092 mSec @ 192 kHz sample rate
Digital Input to Digital Output:	0.0452 mSec @ 192 kHz sample rate
Audio over Ethernet Protocol (HBUS):	0.000592 mSec

System Noise Performance

Noise, A-Weighted:	-93 dBu @ 192 kHz sample rate
Dynamic Range:	117 dB typical

System I/O

Hub Line In, Analog:	8 Balanced inputs on a DB-25 female (DA-88 pinout) per Analog Card
Hub Maximum Input Level, Analog:	+2 dBu with analog card pad jumpers populated, +12dBu with jumpers removed (up to +38dBu upon special request)
Hub HBUS In, Out:	8-pin RJ45 jack (standard Ethernet pinout)
Hub USB Port:	USB 2.0 (for firmware updates)
Hub Card Slots (4x):	Each slot can accept an analog or digital input card, output card, or 8-port Mixer network card
Mixer to Hub Connection:	8-pin RJ45 jack (8x Mixer connections per network card)
Mixer Headphone Out:	1x TRS 1/4" and 1x 1/8" unbalanced stereo
Mixer Line Out:	TRS 1/4" balanced (2 connections: left/mono, right)
Mixer Max Output Level, Analog:	+24 dBu (mixed output)
Mixer Aux Input:	TRS 1/8" unbalanced stereo and XLR balanced mono (with 15 volts phantom power)
Mixer Card Slot:	For future digital or analog input/output expansion capabilities or side-car add-on

Physical, Mixer

Size:	9.5" (241 mm) H x 5.95" (152 mm) W x 2.71" (7.62 mm) D
Unit Weight:	1.6 lb. (0.72 kg)
Mounting:	Standard mic stand (5/8" 27 threads per inch) or desk mounted

Physical, Hub

Size:	1.75" (45 mm) H x 19" (482 mm) W x 8.5" (216 mm) D
Unit Weight:	6.3 lb. (2.8 kg)
Mounting:	Standard rack mount, 1 RU

Power

Hub Power Requirements:	48VDC, 150 Watts (each external power supply powers up to 16 Mixers)***
Mixer Power Requirements:	Power over Ethernet (PoE) 36–52 volts DC, 15 Watts max provided by Hub through CAT6** network cabling
External Power Supply Requirements:	Input Voltage: 90VAC to 264VAC 50/60Hz

Cabling, Mixers and HBUS

CAT6** cables used for Mixers or for HBUS can be run up to 500 feet in *ideal conditions* (one piece of solid conductor CAT6 with no breaks or couplings). The more breaks/connections/couplings in a cable run, the more limited this distance will be. Poor quality cabling will also limit the maximum distance.

Note: 0 dBu = 0.775 Vrms. Specifications and features subject to change without notice.

**Cable complying with the National authorities (cable with an outer jacket or sleeving rated VW-1 or better). *Hear Back PRO User Guide*

***Hub is capable of powering up to 32 Mixers with an additional power supply.

TROUBLESHOOTING AND OPERATING TIPS

**Note: Some problems require you to refer to the A-B-C-D error code LEDs below the HBUS ports on back of Hub.*

No Audio Output	<ul style="list-style-type: none"> • Verify the Hub is powered on. • Check input connections. • Make sure input selector switch is in the proper position for your audio source – HBUS, input A (slots 1 & 2), or input B (slots 3 & 4). • Verify the status-indicating logo on both the Hub and Mixer are both BLUE. • Check your headphones, wireless transmitters/receivers, monitor amplifiers, etc., to verify they are functioning properly.
Hub Logo is solid RED	<p>Refer to the A-B-C-D error code LEDs below the HBUS ports on back of Hub:</p> <ul style="list-style-type: none"> • If no error code LED is lit: <ul style="list-style-type: none"> ◦ No clock is present. ◦ If using an Analog Input card: <ul style="list-style-type: none"> – Verify the input selector switch is in the correct position. – Verify an Analog Input card is present in either slot 1 (for input A) or slot 3 (for input B). – If the problem still persists, please call customer service. ◦ If using any Digital Input card: <ul style="list-style-type: none"> – Verify the digital source is functioning correctly – powered on and sending clock. – Verify the input selector switch is in the correct position. – Verify the Digital Input card is present in either slot 1 (for input A) or slot 3 (for input B). – If the problem still persists, please call customer service. • If error code LED A, B, or A & B are lit: <ul style="list-style-type: none"> ◦ An internal problem is present. Please call customer service. • If error code LED C is lit: <ul style="list-style-type: none"> ◦ No firmware file can be found on the internal SD card. Connect the Hub to a computer via USB. The Hub will appear on the computer as a mass storage device named HBPRO. Download the latest firmware file from our website, and simply drag and drop the file onto the HBPRO, then reboot the Hub. • If error code LED D is lit – alone or in combination with any other error LEDs: <ul style="list-style-type: none"> ◦ An internal power problem has occurred. Please call customer service.
Hub Logo is blinking RED	<p>Refer to the A-B-C-D error code LEDs below the HBUS ports on back of Hub:</p> <ul style="list-style-type: none"> • This is typically an overheating problem – if so, error code LEDs A, B, & C will be lit. <ul style="list-style-type: none"> ◦ Allow adequate ventilation for Hub as specified in owner's manual. • If any other combination of error code LEDs are lit, please contact customer service.
Hub Logo is PURPLE	<ul style="list-style-type: none"> • Verify that there are not two 16-channel input cards on the same input (e.g. slot 1 & slot 2) <ul style="list-style-type: none"> ◦ The Hear Back PRO Hub cannot have more than one 16-channel input card on the same input • If using an off-the-shelf network switch, it might utilize a function known as EEE (Energy Efficient Ethernet). <ul style="list-style-type: none"> ◦ Attempt to bypass the network switch, making a home run from Hub to Mixer, to verify this is the problem – if so, try a known good network switch from the list at the beginning of the Hear Back PRO User Guide.
Hub Logo OFF	<ul style="list-style-type: none"> • Verify power switch is on. • Verify the Hub is receiving power by checking for a yellow LED beneath the power port on the back of the Hub. This LED should be lit when the power supply is connected, even with the Hub powered off. • If the yellow LED is not lit: <ul style="list-style-type: none"> ◦ Verify the external power supply is the unit provided by Hear Technologies. ◦ Replace external supply with known good unit.
Sampling Rate LED is blinking (FW V5 only)	<ul style="list-style-type: none"> • Hub is not set to the same sampling rate as the other Hubs in the system. It can also indicate that there are too many Hubs connected: <ul style="list-style-type: none"> ◦ Maximum of 4 Hubs for 44.1 kHz, 48 kHz, 88.2 kHz, and 96 kHz ◦ Maximum of 3 Hubs for 176.4 kHz and 192 kHz ◦ All other Hubs must be set to "HBUS" input

NOTES

Mixer logo is solid RED	<ul style="list-style-type: none"> • No audio data is being received. <ul style="list-style-type: none"> ○ If an off-the-shelf gigabit switch is being used, the Mixer may not be seeing the Hub clock. <ul style="list-style-type: none"> - Attempt to bypass the network switch, making a home run from Hub to Mixer, to verify this is the problem – if so, try a known good network switch from the list at the beginning of the Hear Back PRO User Guide. ○ Check the orange and green LEDs on the Ethernet port of the Mixer and ensure that you see a solid lit orange LED and a blinking green LED. The lit orange LED indicates that a gigabit Ethernet link is established and the blinking green LED indicates data is being received. <ul style="list-style-type: none"> - If the orange LED is not lit or it lights intermittently, there is a problem with the cabling between the Mixer and the Hub. To verify this, use a known good short Ethernet cable to plug the Mixer directly into the Hub. If the problem still occurs, contact our technical support department. - If the mixer works with the short piece of known good Ethernet cable, investigate the cable between the Hub and the Mixer location. - CAT6* cables, used for HBUS or going to PRO mixers, can be run 100 meters (328 feet) with no problems. Note, due to advanced internal termination techniques, cables used with the PRO series can be run up to 500 feet in ideal conditions (one piece of solid conductor CAT6* with no breaks or couplings). Utilizing proper punch-down and the correct RJ-45 connectors is key. The more breaks/connections/couplings in a cable run, the more limited this distance will be. Poor quality cabling will also limit the maximum distance. - Running CAT6* cables alongside AC cables, florescent light fixtures, or computer network wiring will also limit the maximum distance. It is always preferred to run the Hear Back PRO CAT6* cabling by itself, away from other cabling. - ALL cabling should be electrically tested before use. Contact an expert network professional for assistance with wiring installation.
Mixer Logo is PURPLE	<ul style="list-style-type: none"> • Mixer is not receiving all audio packets. <ul style="list-style-type: none"> ○ Verify Hear Back network is not accidentally connected to a data network. Do not share the Hear Back PRO network with any other devices. ○ Verify all off-the-shelf switches used are indeed rated for gigabit speeds. ○ If using an off-the-shelf network switch, it might utilize a function known as EEE (Energy Efficient Ethernet). <ul style="list-style-type: none"> - Attempt to bypass the network switch, making a home run from Hub to Mixer, to verify this is the problem. If so, try a known good network switch from the list at the beginning of the Hear Back PRO User Guide.
Mixer Logo flashes RED	<ul style="list-style-type: none"> • Internal headphone circuit is overheating. <ul style="list-style-type: none"> ○ Check to verify headphone load is stereo (not mono). ○ Verify 1/4 inch and/or 1/8 inch plug is tip-ring-sleeve (TRS), not tip-sleeve (TS). ○ Look for shorted cables. ○ Verify total load is not below 8 ohms per channel.
When I connect a line level device to the Mixer line outputs, I hear a buzz.	<ul style="list-style-type: none"> • Wire TRS outputs using only black (ring -) and red (tip +) wires. • Disconnect shield at the Mixer and terminate at receiving end only. • For unbalanced outputs, wire the ring (- black) to the receiving end sleeve and tie the shield at the receiving end only. Connect the tip (+ red) to the tip at the receiving end.
When I link two mono channels, the stereo spread is incorrect.	<ul style="list-style-type: none"> • Verify the source (mixer, DAW, etc.) has these outputs panned hard left and right. <ul style="list-style-type: none"> ○ The pan control of the source determines the stereo spread.
No intercom audio	<ul style="list-style-type: none"> • If intercom audio can be heard on the transmitting Mixer, but not other Mixers, either: <ul style="list-style-type: none"> ○ Mixer Firmware is incompatible. Firmware less than 1.7 is not compatible with firmware equal to or greater than 1.7. ○ Intercom has been disabled (see Intercom Operation on page 7).
The fan does not operate.	<ul style="list-style-type: none"> • The fan only runs when power supply temperature reaches 43° C or 110° F.

If you need further assistance, feel free to contact **Hear Technologies** technical support by phone at +1-256-922-1200 or visit our website at <http://www.HearTechnologies.com>.

NOTES

*Cable complying with the National authorities (cable with an outer jacket or sleeving rated VW-1 or better).



SYSTEM ACCESSORIES

PRO MIXER DISTRO

- Allows a single CAT6 cable to be run from a Hear Back PRO Hub to the stage/studio where the PRO Mixers are located.
- Provides (8) RJ45 gigabit Ethernet ports with power for connecting Hear Back PRO Mixers, Hubs, or Distros. A ninth input port is included for connecting to the HBUS out of Hubs or other Distros (unlimited daisy-chaining possible).
- Pre-loaded with a network card already (PRONET) so you can use your existing network card from your Hear Back PRO Hub.
- Durable anodized housing available in black or silver finish.



PRO INTERCOM FOOTSWITCH

- Allows one microphone to double as both a vocal mic for the sound system and an intercom mic for the Hear Back PRO Mixer or Virtual Mixer using your mixing console's mic preamp.
- Pressing the Footswitch silently interrupts audio passed from the microphone to the PA output; audio is then fed to the Hear Back PRO Mixer and the intercom is automatically engaged.
- Can also be used in any application where a momentary A/B XLR switch is needed.
- Does not require any external power or battery.



AM12 AMBIENT MICROPHONE

12 inch condenser gooseneck mic with super cardioid pattern for use with Hear Back PRO Mixer as an ambient or intercom microphone.

The AM12 features 15 volt phantom power, 30Hz – 16kHz frequency response, and -40dB sensitivity.

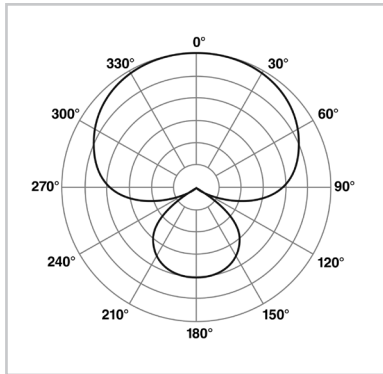

supercardioid pattern



MIXER TILT ADAPTER

The Mixer Tilt Adapter is for all Hear Back Mixers adding a ball joint with 5/8" 27 male threading to any standard mic stand to get the perfect angle with 360° rotation and 180° tilt.



MICROPHONE STAND ADAPTER

Mount the Hear Back Mixer to the side of any mic stand or standard music stand using the MSA Mic Stand Adapter. This clamp-on adjustable width bracket attaches to the built-in 5/8" threaded socket located on the back of the Mixer.



TOTE BACK

This soft-side nylon carrying case is perfect for carrying (8) Hear Back Mixers or (4) Mixers and (1) Hub. Adjustable dividers allow you the freedom to customize the compartments.



CABLES

Hear Technologies offers a variety of quality cables that work with your system including CAT5e, CAT6, Optical, Insert and Analog DA-88 style cables.



CAT5 & CAT6

OPTICAL

INSERT

ANALOG



OTHER HEAR TECHNOLOGIES PRODUCTS

HEAR BACK OCTO

- Local control of up to 10 channels of audio (eight inputs plus a stereo AUX input)
- Master Volume controls the level of headphones, line outs, and AUX input
- Audio inputs ADAT, analog, and HearBus are switch-selectable from the front panel
- Capacitive touch link buttons
- Standard CAT5e power and signal connection
- 100% backwards compatible with the original Hear Back system
- Compatible with the Hear Back PRO system via optional PRO Hub ADAT Card
- Includes 1/8" and 1/4" headphone jacks



SWITCH BACK M8RX

- 4x4 Dante (4 Dante Inputs and 4 Dante Outputs)
- Master volume control for headphones
- Easy access to all volume controls on face of unit
- Dual-color signal and peak indicators on each input channel
- Concentric volume control on each channel reduces space and simplifies user interface by placing local inputs on the tips and Dante inputs on the rings of each knob
- True 48-volt phantom power remotely/locally selectable on each microphone input



WSG BRIDGE

- Up to 64 channels of SoundGrid
- Up to 64 channels of Dante
- Supported sample rates: 44.1–96 kHz
- Clock source: SoundGrid/Dante
- 1U rack-mountable
- Redundant power supply (optional, separate purchase)
- Exclusively available through a Waves Audio Distributor (www.waves.com)



LIMITED WARRANTY

Hear Technologies warrants the equipment against defects in materials and labor for a period of one year from the original date of purchase. The duration of this warranty is limited to claims made to Hear Technologies within the periods stated with respect to parts and labor from the date of purchase. During the warranty period, defective equipment will be replaced or repaired to the general condition as received, at the discretion of Hear Technologies.

All transportation is the responsibility of the purchaser or owner. Equipment should be shipped in the original shipping box.

This warranty applies only to defects in materials and workmanship and does not cover failure or damage due to shipping loss or damage, abuse, misuse, misapplication, incorrect or varying power line voltages, lack of proper maintenance, natural disasters, acts of God, or unauthorized modifications, repairs, or any alterations done without the expressed

written consent by Hear Technologies. Hear Technologies shall not be liable for any loss of use of the equipment, or consequential damages, including damages to other parts of the installation in which the equipment is a part.

Hear Technologies does not make any warranty, express or implied, other than the warranty contained herein. No agent, representative, or employee has the authority to increase or alter the liability, obligations, and terms of this warranty or sale of the equipment. NOTE: It is strongly recommended that any equipment returned to Hear Technologies be properly packaged and insured for its full value in case of loss, handling or shipping damage.

Hear Technologies shall not be responsible for damage or loss of equipment during shipment.

The following are registered trademarks of Hear Technologies:

Hear Technologies, Hear Back, Control Your Mix, Talk Back, Extreme Extender, Hearbuds, HearBus, and the "Jack" logo.

All names and marks of other companies belong to those respective companies.



HEAR TECHNOLOGIES®

991Discovery Drive
Huntsville, AL 35806

Phone: +1-256-922-1200

Fax: +1-256-922-1221

www.HearTechnologies.com