

User Manual

4K60 (4:4:4) 70M HDMI MATRIX RECEIVER

70 METER HDMI RECEIVER VIA HDBaseT, BUILT TO WORK WITH THE HDBaseT
MATRICES FROM AVPRO EDGE.



The AC-EX70-444-RNE is a revolutionary 4K60 4:4:4, HDR and 18Gbps supported HDBaseT Receiver built to work with the AVPro Edge HDBaseT Matrix Switchers.

This HDBaseT Receiver is the perfect companion to AVPro Edge's HDBaseT matrix switchers. It's slim design and rich features make this small unit the perfect solution for HDR Distribution. Using standard category you are able to distribute a 18Gbps signal up to 70 meters. Utilizing ICT (Invisible Compression Technology) we have achieved what was thought to be impossible. We can deliver a virtually lossless high bandwidth 4K HDR signal with support for all signals up to 18Gbps. Deep Color and HDR Metadata remain intact making the transmission free of artifacts like banding. Other similar devices will deliver a sub-par image that has very visible banding and color shifting.

Product Overview

Model Numbers: ■ AC-EX70-444-RNE ~ HDBaseT Receiver w/ IR, RS-232, ARC, Test Patterns

Features:

- HDMI 2.0(a/b)
- 18Gbps Bandwidth Support (Using ICT)
- Ultra Slim (.67 inch/17mm)
- Up to 4K60 4:4:4 Support
- Full HDR Support (HDR 10 & 12 Bit)
- HDR, HDR10+ and HLG Support
- 4K --> 1080P Down-scaling for mixed systems
- EDID Management and EDID emulate
- 4K & HD Test Patterns built-in for troubleshooting
- L/R Audio Extraction
- HDCP 2.2 (and all earlier versions supported)
- CEC Pass Through
- 3D Support
- 100M (330ft) on 1080P (Cat6a)
- 150M (492ft) at 1080p "LONG RANGE MODE"
- Up to 70m (230ft) on 4K (up to 4K60 4:4:4, HDR) (Cat6a)
- Bi-directional 48v PoH (Power Over HDBaseT from Matrix)
- 3-20v protection circuit built-in for safe IR transport
- Bi-Directional RS-232 transport
- LED Status, Link, Power indication lights
- Supports uncompressed PCM 2- Ch., LPCM 5.1 & 7.1, Dolby Digital, DTS, Dolby TrueHD, DTS HD-Master Audio, Atmos on HDMI
- ESD protection circuitry (Inputs & Outputs) to 7KV

■ What's In The Box

- AC-EX70-444-RNE (Receiver)
- 1x IR Tx Unit
- 1x IR Rx Unit
- Mounting Ears

***NOTE: Optional 3PIN to STEREO Audio Cables available for purchase "AC-CABLE-3PIN-2CH"**

VIDEO:	
VIDEO RESOLUTIONS	UP TO 4K 60HZ 4:4:4
VESA RESOLUTIONS	UP TO DCI 4K (4096X2160)
HDR FORMATS/RESOLUTIONS	420, 422, 444 (10 AND 12 DEEP COLOR) HDR10, HDR10+, DOLBY VISION (24/30 FRAMES), HLG, DOLBY VISION
COLOR SPACE	YUV (COMPONENT), RGB (CSC: REC. 601, REC. 709, BT2020, DCI, P3 D6500)
CHROMA SUBSAMPLING	4:4:4, 4:2:2, 4:2:0 SUPPORTED
DEEP COLOR	UP TO 16 BIT (1080), UP TO 12 BIT (4K)
DOWN SCALING	4K (AND HDR) DOWN TO 1080P
AUDIO:	
AUDIO FORMATS SUPPORTED HDMI	PCM 2.0 CH, LPCM 5.1 & 7.1, DOLBY DIGITAL, DTS 5.1, DOLBY DIGITAL PLUS, DOLBY TRUEHD, DTS-HD MASTER AUDIO, DTS-X, DOLBY ATMOS
AUDIO FORMATS SUPPORTED EXTRACTED (2CH PORT)	PCM 2 CH (NO DOWNMIX)
DISTANCE:	
HDBASET (CAT) DISTANCE (4K)	70 METERS / 230 FEET (CAT 6A)
HDBASET (CAT) DISTANCE (FULL HD)	100 METERS / 330 FEET (CAT 6A)
HDMI LEAD IN/OUT (4K60 4:4:4)	UP TO 50 FEET (USING BULLET TRAIN HDMI)
HDMI LEAD IN/OUT (W/ AOC CABLE) (4K60 4:4:4)	UP TO 130 FEET (USING BULLET TRAIN AOC)
OTHER:	
BANDWIDTH	18 GBPS (W/ ICT)
HDCP	HDCP 2.2 AND EARLIER
PORTS:	
HDMI	TYPE A
HDBASET	RJ45 W/ POH FOR HDBASET RECEIVERS
AUDIO (EXTRACTED ANALOG)	3 PIN TERMINAL BLOCK (UNBALANCED)
IR TX	3.5MM MONO (2 CONDUCTOR)
IR RX	3.5MM STEREO (3 CONDUCTOR)
RS232	3 PIN TERMINAL BLOCK
POWER	2 PIN TERMINAL BLOCK
ENVIRONMENTAL:	
OPERATING TEMPRATURE	23 TO 125°F (-5 TO 51°C)
STORAGE TEMPERATURE	-4 TO 140°F (-20 TO 60°C)
HUMIDITY RANGE	5-90% RH (NO CONDENSATION)
POWER:	
POWER CONSUMPTION (TOTAL)	12 WATTS MAX
POWER SUPPLY - MATRIX	INPUT: AC 100-240V ~ 50/60HZ OUTPUT: DC 48V 0.5A
DIMENSIONS:	
DIMENSIONS (UNIT ONLY HEIGHT/DEPTH/WIDTH)	MM: 132 X 100 X 18 INCH: 5.19 X 3.94 X 0.69
DIMENSIONS (PACKAGED HEIGHT/DEPTH/WIDTH)	MM: 137 X 194 X 45 INCH: 5.38 X 7.62 X 1.75
WEIGHT (UNIT)	0.5 LB/0.23 KG
WEIGHT (PACKAGED)	1 LBS/0.45 KG

*SPECIFICATIONS SUBJECT TO CHANGE WITHOUT NOTICE. MASS & DIMENSIONS ARE APPROXIMATE

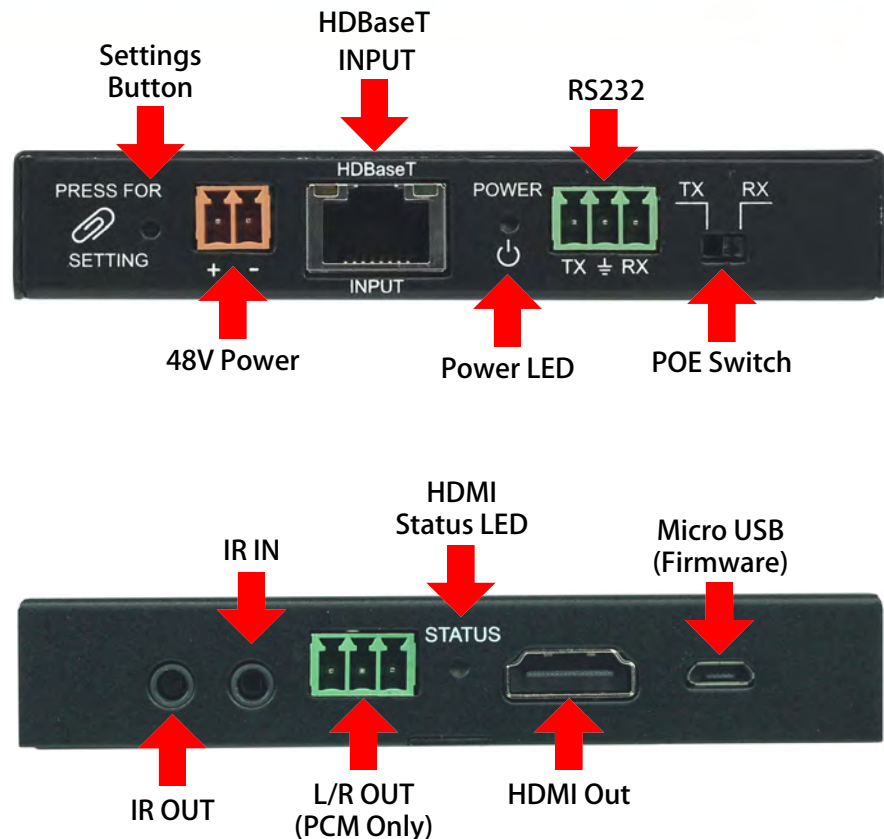
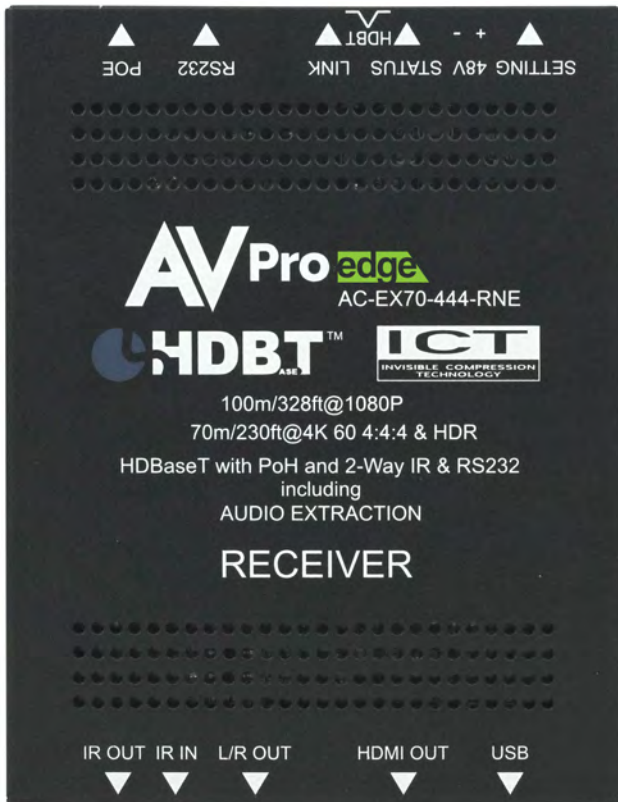

Indicator Troubleshooting Lights on the Receiver:

POWER - On the back: (Red) This is an indicator that the power is connected. There are only two states for light:

- Light Is On = Power supply is connected and functioning.
- Light Is Off = Power supply is not connected or there is no power present. (In order to have power: check the power supply, USP, Outlet, etc...)

HDBaseT LINK - On the back: (Blue) This is an indicator that that the RJ45 HDBaseT Link is stable.

This light should always be SOLID.

HDMI SIGNAL STATUS - On the front: (Blue) This indicator shows that the HDMI Sink is connected.

The states are:

- Light Is On (Solid) = Sync w/ HDMI sink is correct and solid.
- Light Is Flashing = The light flashes during the sync process. If it is flashing continuously, you may still have a picture, but it is indicating that the Rx is correcting a BE (Bit Error) to make the picture show on the display.

If the **BLUE HDMI SIGNAL STATUS LIGHT** is flashing AND you have no picture, check the following:

1. The source. Plug it directly into the display to be sure it's functioning properly.
2. Try a longer HDMI cable. Some HDMI cables do not sync well at shorter lengths.
3. If these suggestions do not work, enable the "Test Pattern" (See Below). If you see the pattern, the problem is between the Receiver and display/sink please try a different sink input or HDMI cable.
4. Contact AVProEdge if these suggestions do not work.

Indicator Troubleshooting Lights on the Receiver cont.:

LINK - Above RJ45 (HDBT) Port: (Green) This indicator shows that the AV HDBT link between the Transmitter and Receiver is in tact. This light will ALWAYS be solid. If this light is flashing or not present do the following:

1. Check the length. The maximum distances are 70m (230ft) on 4K and 100m (330ft) on 1080P.
2. Remove any coils of cable and make sure that there is not excess cabling.
3. Bypass all patch panels and punch-down blocks.
4. Re-terminate connectors. Sometimes, even if a cable tester indicates the run is valid, something may be slightly off.
5. Contact AVProEdge if these suggestions do not work.

STATUS- Above RJ45 (HDBT) Port: (Amber) This indicator shows that the power is present between the Transmitter and Receiver. This light ALWAYS BLINKS steadily indicating everything is correct. If you do not see this light, try the following:

1. Check the length. The maximum distances are 70m (230ft) on 4K and 100m (330ft) on 1080P.
2. Remove any coils of cable and make sure that there is not excess cabling.
3. Bypass all patch panels and punch-down blocks.
4. Re-terminate connectors. Sometimes, even if a cable tester indicates the run is valid, something may be slightly off.
5. Try powering from the Receiver instead of the Transmitter (See Receiver page for more about PoE direction).
6. Contact AVProEdge if these suggestions do not work.

Functions & Setup of the Receiver:

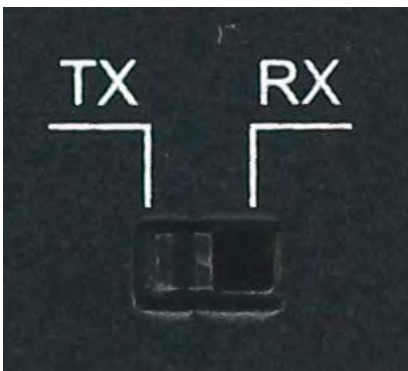

PoE Mode Slide Switch: (On the back) This is used to select how you want to PoE is to be directed. There are two options (you are choosing where the power is ORIGINATING from):

- **TX (Default)**= You will need to power the TRANSMITTER side, the receiver will be powered over the CAT Cable (Default).
- **RX** = You will need to power the RECEIVER, the transmitter will be powered over the CAT Cable from the receiver (This is called "Reverse Power").

Using the Setting Button: (On Front) The setting button can be pressed in different combinations based on what is needed. Using an ink pen is best to press the button.

The SETTING BUTTON is located just to the right of the



symbol. The POWER LED is the indicator light.



BUTTON (Recessed)

■ RS-232 Configuration

RS-232 can be used to pass control signals bi-directionally to & from any RS-232 compatible device. This is commonly used to route control signals in the following way:

1. Control System --> Display/Projector (ie, Power On/Off)
2. Display/Projector --> Control System (ie, Display Status, Volume Status etc...)
3. When ultra long-range serial communication is needed (think concerts, live events). Use the extender.

The unit comes with 3 pin connectors to allow for any wire an integrator would like. The pin out configuration Left=TX, Center=Ground, Right=RX and looks like this:

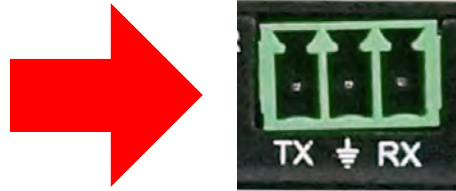

This is how the cable should look. If using the AC-CABLE-3.5-DB9F (Female) or AC-CABLE-3.5-DB9M (Male), the colors will be the same. With any other cable, please follow Tx, G, Rx as shown below. See RS-232 cable preparation diagram below



RS-232 CABLE FOR AVPRO EDGE

IN ORDER TO CONNECT YOUR COMPUTER TO THE SWITCH BY RS-232 YOU NEED TO MAKE YOUR OWN CABLE WITH ONE END A PHOENIX CONNECTOR AND THE OTHER END A RS-232 PORT. YOUR COMPUTER DOESN'T HAVE A RS-232 INPUT, GET A USB CONVERTER (AS SHOWN BELOW), AND PLUG THE USB END TO ANY COMPUTER

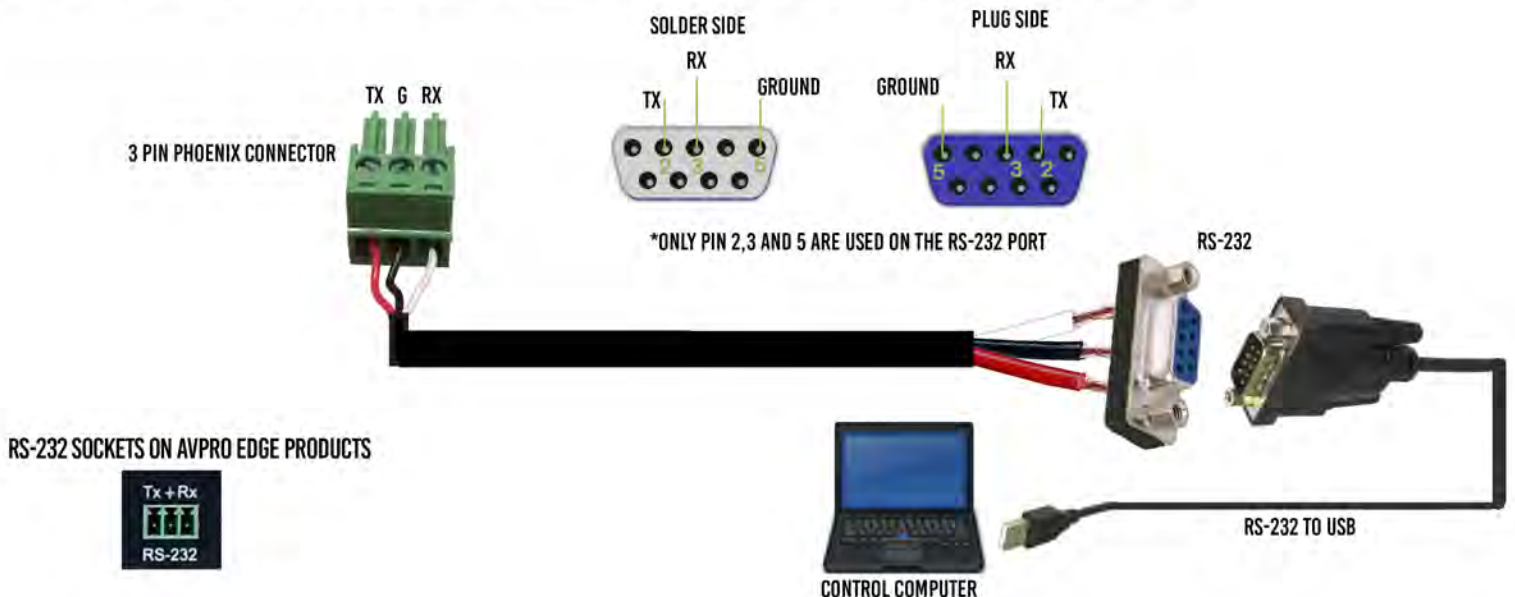

▪ **IR Configuration**

IR can be used in three ways:

1. From Rack (Control System Direct): Plug a MONO 3.5mm cable into an emitter port of any control system directly into the "IR IN" port on the AC-MX44/88-AUHD-HDBT switch to pass IR signals directly to the remote end.
2. From Rack (Using IR-EYE): Plug an IR-Receiver Eye into the "IR IN" of the AC-MX44/88-AUHD-HDBT switch in order to pass infrared signals generated from a device or IR Remote.
3. From Remote End: Use an IR-Receiver Eye on the AC-EX70-444-RNE (IR In Port) in order to send IR signals BACK to the rack and out of the switch IR Out Port with an emitter.

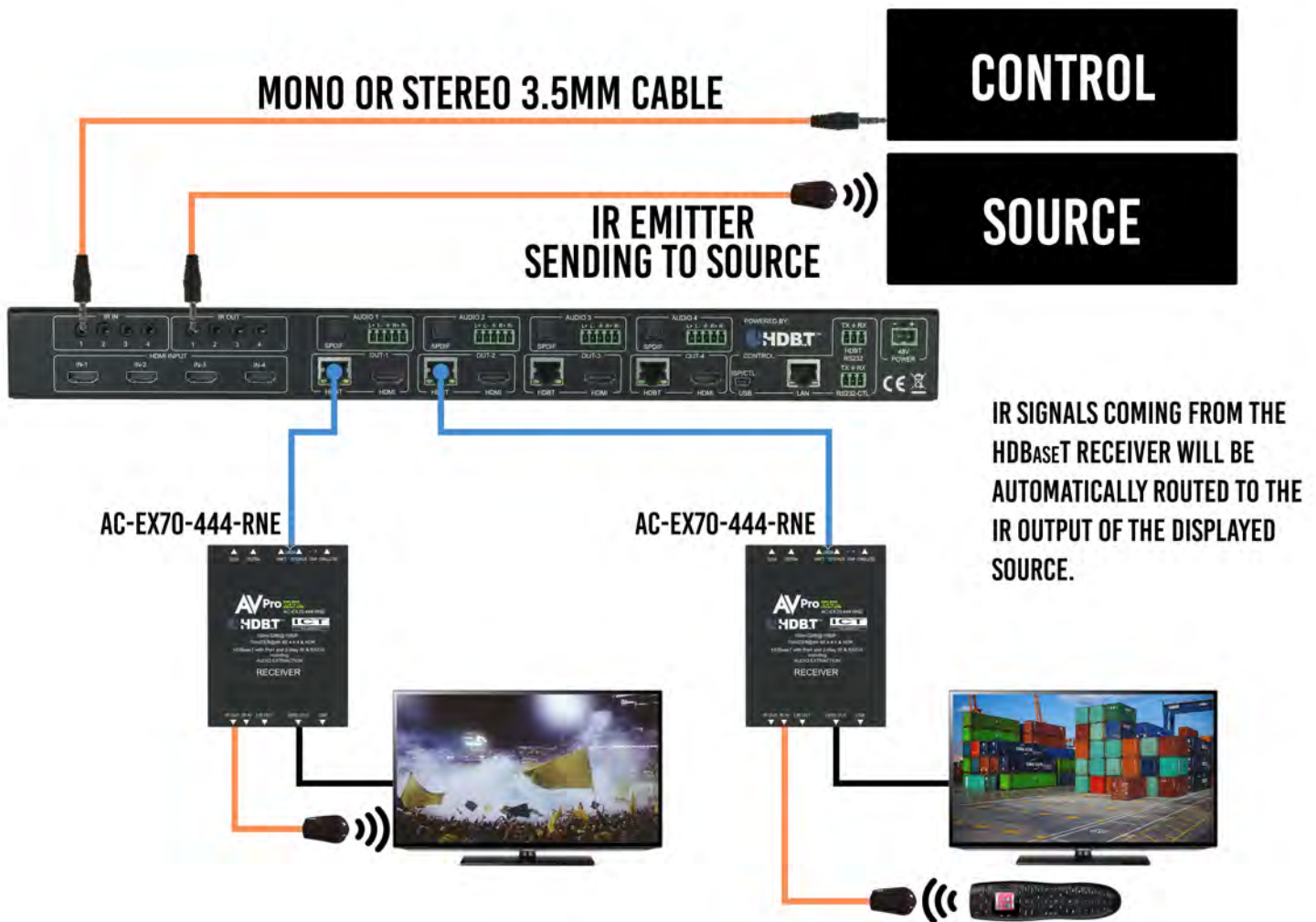

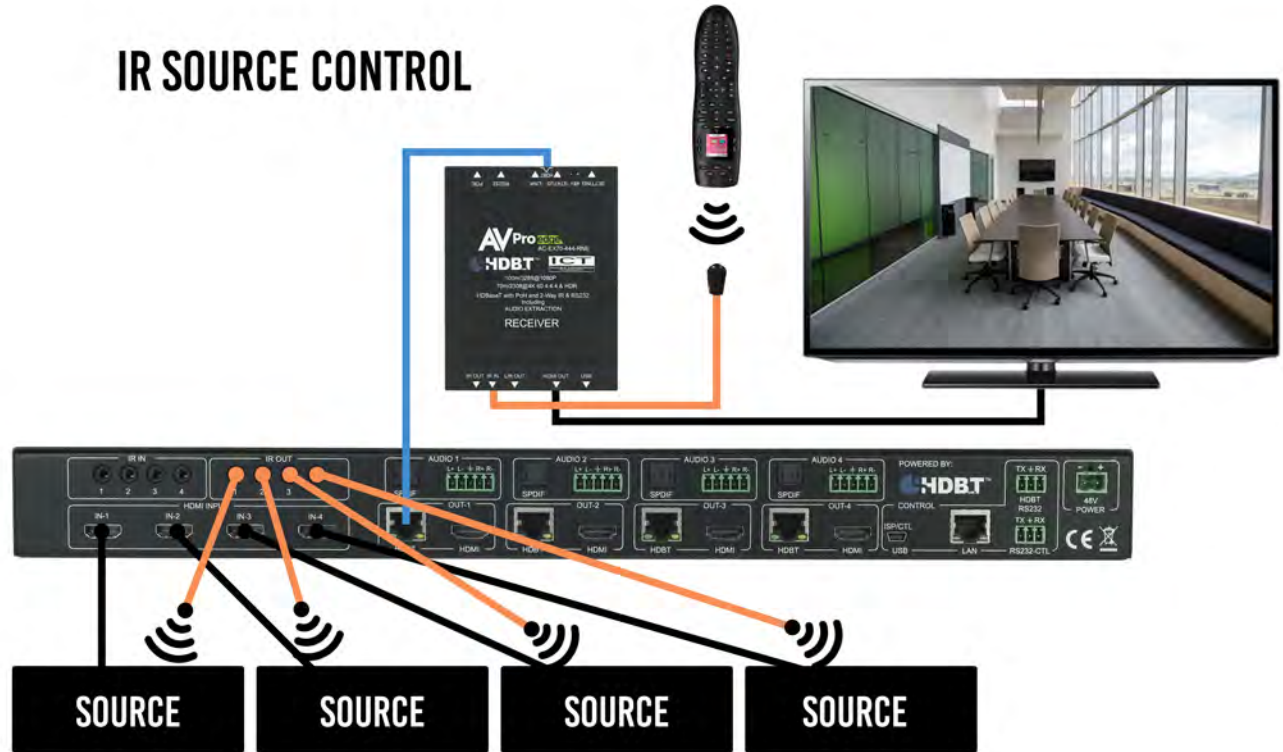

■ **IR Connections**



IR I-PASS (Direct connection to Matrix)

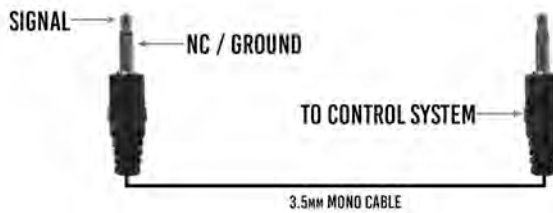

■ Audio Extraction on AC-EX70-RNE

A feature that is always active on the AC-EX70-444 (Tx and Rx) is Audio Extraction. This feature extracts PCM Audio (2ch) from the source device in order to be run to a separate amplifier or AVR. The extracted audio port is always active.



- To use the ports: 1. Simply plug a 3 pin terminal block into the port on the Rx
- 2. There is an option to buy pre-made unbalanced 3-pin to RCA Female cables.

a. Part number is AC-CABLE-3PIN-2Ch

NOTE: The source device needs to output PCM audio in order for the feature to work. This can be done by using the on-board EDID management on the switch, or setting the source as such. If downmixing is needed, check out AC-ADM-AUHD or AC-ADM-COTO.

■ Audio Extraction Routing Diagram

AUDIO EXTRACTION

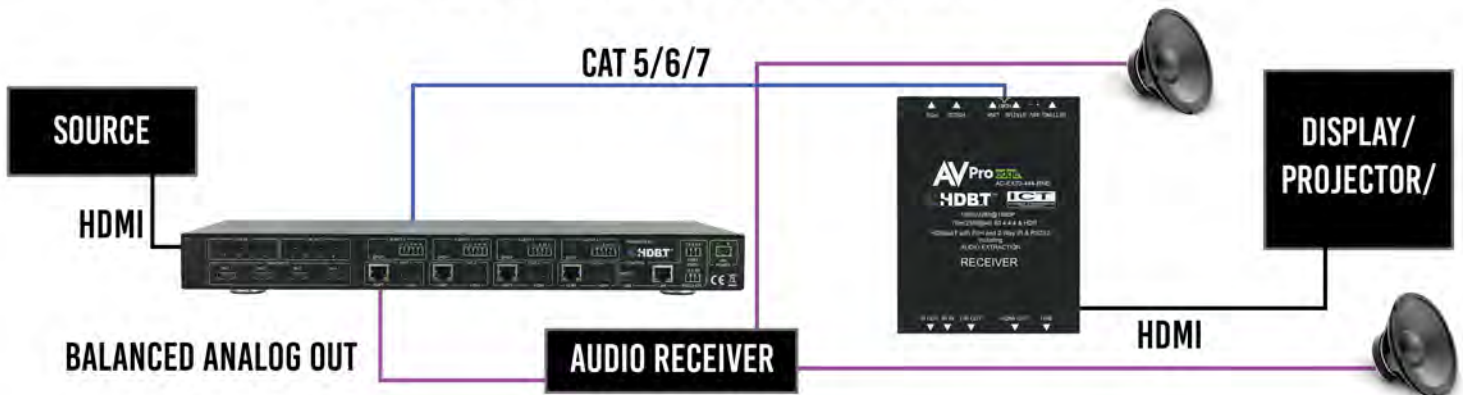

▪ *Troubleshooting*

- Verify Power - Pg. 4
 - Verify POE Switch is correct - Pg. 4
- Verify Connections - Check that all cables are properly connected
 - RX Indicator Troubleshooting Lights -Pg. 4-5
- Not passing video, this may be an EDID issue. Out of the box the default is 1080p 2CH. Try another canned EDID or copy the connected displays. See manual for the Matrix Switch you are using.
- To verify connection from Switch through Receiver to the display, enable the built in TEST PATTERN from the Matrix (see Matrix manual).
- IR Issues - Verify correct connections - P. 7-8
 - Visibly flashing Emitters may not function properly, try the IR Cables that come in the box if you are experiencing issues
- Extracted Audio Issues - Pg. 9
 - Verify Source is set to output 2ch
 - **Note: This unit does NOT downmix**
- Still having issues, contact us
 - Support Direct - +1-605-977-3477
 - All Inquiries - 1-605-274-6055
 - Submit a support request ticket
 - <https://support.avproedge.com/hc/en-us/requests/new>

▪ *Troubleshooting*

- Verify Power - Pg. 4
 - Verify POE Switch is correct - Pg. 4
- Verify Connections - Check that all cables are properly connected
 - RX Indicator Troubleshooting Lights - Pg. 4-5
- Not passing video, this may be an EDID issue. Out of the box the default is 1080p 2CH on our Matrices. Try another canned EDID or copy the connected displays. See manual for the Matrix Switch you are using.
- To verify connection from Switch through Receiver to the display, enable the built in TEST PATTERN from the Matrix (see Matrix manual).
- IR Issues - Verify correct connections - P. 7-8
 - **Note: Visibly flashing Emitters may not function properly, try the IR Cables that come in the box if you are experiencing issues**
- Extracted Audio Issues - Pg. 9
 - Verify Source is set to output 2ch
 - **Note: This unit does NOT downmix**
- Still having issues, contact us
 - Support Direct - +1-605-977-3477
 - All Inquiries - 1-605-274-6055
 - Submit a support request ticket
 - <http://support.avproedge.com/hc/en-us/requests/new>

▪ ***Maintenance***

To ensure reliable operation of this product as well as protecting the safety of any person using or handling this device while powered, please observe the following instructions.

- Use the power supplies provided. If an alternate supply is required, check voltage, polarity and that it has sufficient power to supply the device it is connected to.
- Do not operate these products outside the specified temperature and humidity range given in the above specifications.
- Ensure there is adequate ventilation to allow this product to operate efficiently.
- Repair of the equipment should only be carried out by qualified professionals as these products contain sensitive components that may be damaged by any mistreatment.
- Only use this product in a dry environment. Do not allow any liquids or harmful chemicals to come into contact with these products.
- Clean this unit with a soft, dry cloth. Never use alcohol, paint thinner or benzene to clean this unit.

▪ ***Damage Requiring Service***

The unit should be serviced by qualified service personnel if:

- The DC power supply cord or AC adaptor has been damaged
- Objects or liquids have gotten into the unit
- The unit has been exposed to rain
- The unit does not operate normally or exhibits a marked change in performance
- The unit has been dropped or the housing damaged

■ *Support*

Should you experience any problems while using this product, first, refer to the Troubleshooting section of this manual before contacting Technical Support. When calling, the following information should be provided:

- Product name and model number
- Product serial number
- Details of the issue and any conditions under which the issue is occurring

■ *Warranty*

If your product does not work properly because of a defect in materials or workmanship, AVProEdge (referred to as “the warrantor”) will, for the length of the period indicated as below, (Parts/Labor (10) Years), which starts with the date of original purchase (“Limited Warranty period”), at its option either (a) repair your product with new or refurbished parts, or (b) replace it with a new or a refurbished product. The decision to repair or replace will be made by the warrantor. During the “Labor” Limited Warranty period there will be no charge for labor. During the “Parts” warranty period, there will be no charge for parts. You must mail-in your product during the warranty period. This Limited Warranty is extended only to the original purchaser and only covers product purchased as new. A purchase receipt or other proof of original purchase date is required for Limited Warranty service.

This warranty extends to products purchased directly from AVPro or an authorized dealer. AVPro is not liable to honor this warranty if the product has been used in any application other than that for which it was intended, has been subjected to misuse, accidental damage, modification or improper installation procedures, unauthorized repairs or is outside of the warranty period. Please direct any questions or issues you may have to your local dealer before contacting AVPro.

Thank you for choosing AVProEdge!

Please contact us with any questions, we are happily at your service!



AVProEdge
2222 E 52nd St N ~ Sioux Falls, SD 57104

1-877-886-5112 ~ 605-274-6055
support@avproedge.com