

Instruction Manual



MODEL : SB-5642
4x2 HDMI MATRIX SWITCHER

HDMI Matrix Switcher Series

Thank you for purchasing the SB-5642 4x2 HDMI Matrix Switcher. You will find this unit easy to install and highly reliable but it is essential that you read this manual thoroughly before attempting to use 4x2 HDMI Matrix switcher.



SAFETY INFORMATION



CAUTION

RISK OF ELECTRIC SHOCK
DO NOT OPEN



CAUTION: TO REDUCE THE RISK OF ELECTRIC SHOCK,
DO NOT REMOVE COVER (OR BACK).
NO USER SERVICEABLE PARTS INSIDE.
REFER SERVICING TO QUALIFIED SERVICE PERSONAL.

WARNING!

TO REDUCE THE RISK OF FIRE OR ELECTRIC SHOCK
DO NOT EXPOSE THIS EQUIPMENT TO RAIN OR MOISTURE.



This symbol is intended to alert the user to the presence of uninsulated "dangerous voltage" within the products enclosure that enclosure may be of sufficient magnitude to constitute a risk of electric shock to persons.



This symbol is intended to alert the user to the presence of important operational and maintenance (servicing) instructions in the literature accompanying the appliance.

Caution: To prevent electric shock do not use this (polarised) plug with an extension cord, receptacle or other outlet unless the blades can be fully inserted to prevent blade exposure. To prevent electric shock, match wide blade of plug to wide slot, fully insert.

1. Save the carton and packing material even if the equipment has arrived in good condition. Should you ever need to ship the unit, use only the original factory packing.
2. Read all documentation before operating your equipment. Retain all documentation for future reference.
3. Follow all instructions printed on unit chassis for proper operation.
4. Do not spill water or other liquids into or on the unit, or operate the unit while standing in liquid.
5. Make sure power outlets conform to the power requirements listed on the back of the unit.
6. Do not use the unit if the electrical power cord is frayed or broken. The power supply cords should be routed so that they are not likely to be walked on or pinched by items placed upon or against them, paying particular attention to cords and plugs, convenience receptacles, and the point where they exit from the appliance.
7. Always operate the unit with the AC ground wire connected to the electrical system ground. Precautions should be taken so that the means of grounding of a piece of equipment is not defeated.
8. Mains voltage must be correct and the same as that printed on the rear of the unit. Damage caused by connection to improper AC voltage is not covered by any warranty.
9. Power down & disconnect unit from mains voltage before making connections.
10. Never hold a power switch in the " ON " position.
11. Do not use the unit near stoves, heat registers, radiators, or other heat Producing devices.
12. Do not block fan intake or exhaust ports. Do not operate equipment on a surface or in an environment which may impede the normal flow of air around the unit, such as a bed, rug, carpet, or completely enclosed rack. If the unit is used in an extremely dusty or smoky environment, the unit should be Periodically " blown free " of foreign matter.
13. Do not remove the cover. Removing the cover will expose you to potentially dangerous voltages. There are no user serviceable parts inside.
14. Do not drive the inputs with a signal level greater than that required to drive equipment to full output.
15. Non-use periods. The power cord of equipment should be unplugged from the outlet when left unused for a long period of time.
16. Service Information Equipment should be serviced by qualifier service personnel when:
 - A. The power supply cord or the plug has been damaged.
 - B. Objects have fallen, or liquid has been spilled into the equipment.
 - C. The equipment has been exposed to rain
 - D. The equipment does not appear to operate normally, or exhibits a marked change in performance
 - E. The equipment has been dropped, or the enclosure damaged.

IMPORTANT SAFETY INSTRUCTIONS

To insure the best from this product, please read this manual carefully. Keep it in a safe place for future reference.

To reduce the risk of electric shock, do not remove the cover from the unit. No user serviceable parts inside. Refer servicing to qualified personnel.

To reduce the risk of fire, do not expose the unit to rain, water or excessive moisture.

Do not force switched or external connections.

When moving the unit disconnect the serial port connections first then the power cable and finally the interconnecting cables to other devices.

Do not attempt to clean the unit with chemical solvents or aerosol cleaners, as this may damage the unit. Use a clean dry cloth.

Installation of this unit should be in a cool dry place, away from sources of excessive heat, vibration, dust, moisture and cold.

THIS SAFETY INFORMATION IS OF A GENERAL NATURE AND MAY BE SUPERSEDED BY INSTRUCTIONS CONTAINED WITHIN THIS MANUAL

TABLE OF CONTENTS

TABLE OF CONTENTS	3
INTRODUCTION AND FEATURES	4
SPECIFICATIONS	5
EDID SETUP	6
EDID LEARNING	7
EDID FUNCTIONS	8
CEC SETUP	9
FRONT PANEL	10
FRONT PANEL - CONTROL FUNCTIONS	11
REAR PANEL	12
TYPICAL APPLICATION- IR to Room	13
TYPICAL APPLICATION- IR from Room	14
IR EXTENDER	15
REMOTE CONTROL	16
REMOTE CONTROL - DATA CODE LIST	17
RS-232 SERIAL INTERFACE	18

INTRODUCTION AND PACKAGE CONTENTS

INTRODUCTION

The SB-5642 is high-performance 4x2 matrix routing switcher for HDMI signals. This switcher supports data rates up to 6.75 Gbps, enabling 1080p HDMI formats and UXGA/WUXGA/DVI resolution to any HD display. High Definition Digital signals can be selected and distributed to any 2 outputs simultaneously. The Switcher is certified as being fully HDMI[®] and HDCP[®] compliant, with RoHS, CE, FCC certification. Support high resolution HDMI sources routed to HDMI displays, monitors, projector or audio receivers. The EDID can be selected between seven (8) different modes. Control is provided via Front panel push buttons, IR remote or via RS-232. An RS232 Windows GUI interface is provided for matrix routing.

FEATURES

1. 4x HDMI digital source devices matrix switched to 2x HDMI devices.
2. HDMI digital video w/embedded audio, DVI format and CEC/HDCP 2.0 compliant
3. Seven (7) function key control and worldwide EDID modes for HDTV resolutions.
4. Link speeds of up to 6.75 Gbps (link clock rate of 225Mb Hz), Support HDMI 1.4a 3D formats.
5. Wide range of HD resolutions from PC XGA to WUXGA 1920x1200 and HDTV/DTV resolutions 480i/480p, 576i/576p, 720p, 1080i & 1080p
6. Compatible with all HDMI source devices, PC monitors, Plasma HD display, HDTV and audio receivers/amplifiers.
7. Digital Video TMDS formats Resolutoin up to 1080P-60 with Deep color 36-bit.
8. Digital Audio Support : - Dolby TrueHD, Dolby Digital, Dolby Digital Plug/ex,
- DTS, DTS-HD, DTS-HD Master, DTS-EX
- PCM, PCM2, LPCM2..
9. Various User Interface control:
 - Windows based GUI control via RS232 port
 - Front Panel push button
 - IR wireless remote control
 - Third party RS232 controller (via simple ASCII)
10. Support world wide control functions: ALL/OFF/RECALL/ENTER/MEMORY/EDID/LOCK
11. Support EDID modes :
Internal modes : AUTO/1080P-2CH/1080P-5.1/1080P-7.1/1080i-2CH/720P-2CH
External modes : Passing mode.
12. Automatic scanning input & output status via LED show on front panel.
13. Support IR Remote and IR Extender with distance up to ~ 1000' (300M) Maximum.
14. EDID configuration via Internal modes.
15. Consumer Electronic Control (CEC) switch all open or OFF
The Switcher will remember that last state during a power cycle.
When power is removed and resorted, the last configuration will be invoked.

PACKAGE CONTENTS

1. Main console unit
2. Operating Instructions
3. IR Remote Controller (SW-5642)
4. 19 inch Ear mount bracket (Part # 1U-440L)
5. IR Extender receiver (SB-100)
6. CD Contents: This manual, Windows GUI
7. RS232 Cable
8. Power Supply 12VDC, 3A UniversalType 50/60Hz, 100~230 VAC

SPECIFICATIONS

SPECIFICATIONS

Type of HDMI Switcher	4x HDMI inputs To 2x HDMI Outputs Matrix Switcher
HDMI Support	HD 1080P-@60Hz, H36-bit Deep color, 3D (1.4a) formats.
HDCP / CEC Support	HDCP 2.0 Compliant, CEC Compliant.
Video Bandwidth	Double Data Rates:225Mhz, Total 6.75Gbps bandwidth.
Digital Video Support	Full HD resolution : 480i / 480p / 720p / 1080i / 1080p
Digital Audio Support	Multi Audio Formats 5.1 / 7.1, MAT(MLP) Dolby Digital, Dolby TrueHD, Dolby Digital Plus, DTS, DTS-ES 6.1, DTS-HD, DTS-HD-HRA, DTS-HD Master, (PCM-2CH)
Controls	IR Remote Controller IR External port x 1 (OD 3.5mm Ear phone Jack) Select & Function buttons on front panel RS 232 series interface
Preview output	
Source Status	Automatically Scan Sources Inputs via LED
Function Control Key	ALL / OFF / RECALL / ENTER / MEMORY / LOCK / EDID
Infrared Frequency	38 Khz
IR External Distance	~1000 feet / 300 meters maximum.
HDMI I/O Connector	HDMI Type A - SMD 19pin Female Type
Temperature	32°F - 100°F Operation (0°C - 38°C)
Dimensions	LxWxH=19" x 9.85" x 1.75" (482mmx250mmx44mm)
Rack Mount	Rack Mount 1RU High 19" Rack Mount (with rack mount)
Power Supply	DC12V / 3A, Universal world wide Type 50/60Hz, 100~230 VAC
Power Consumption	2150 mA Maximum
Safety Approvals	CE, FCC, RoHS (2002/95/EC).
Product Weight	1.55 Kgs / 2.58 lb

As product improvement is continuous, specifications are subject to change and without notice or liability.

EDID FUNCTION

EDID function for HDMI Matrix Switcher

EDID setup	To change the EDID setup
Step 1 . Press the EDID button	The display will show the currently selected EDID mode
Step 2 . Press SOURCE #1 or #2 button row	The button will flash blue and the display will show the current Embedded EDID Status.
Step 3 . Press the ENTER button	To set EDID mode. The switcher will return to operation mode.
Operation will abort if no keys are pressed within 5 seconds.	

6.1 Embedded EDID modes	Total 8 EDID Modes								
<p>Embedded EDID setup</p> <p>Press EDID > SOURCE > ENTER</p> <p style="margin-left: 40px;">SOURCE #1 or SOURCE #2</p>	<p>to select EDID mode.</p> <p>Repeatedly depressing the source 1 button will cycle up thru the options. Repeatedly depressing the source 2 button will cycle down thru the options.</p> <table style="width: 100%; border: none;"> <tr> <td style="width: 50%;">Mode 1 : FSS</td> <td style="width: 50%;">Mode 5 : H36M</td> </tr> <tr> <td>Mode 2 : H24-3D</td> <td>Mode 6 : H36-3D</td> </tr> <tr> <td>Mode 3 : H24M-3D</td> <td>Mode 7 : H36M-3D</td> </tr> <tr> <td>Mode 4 : H36</td> <td>Mode 8 : AUTO</td> </tr> </table>	Mode 1 : FSS	Mode 5 : H36M	Mode 2 : H24-3D	Mode 6 : H36-3D	Mode 3 : H24M-3D	Mode 7 : H36M-3D	Mode 4 : H36	Mode 8 : AUTO
Mode 1 : FSS	Mode 5 : H36M								
Mode 2 : H24-3D	Mode 6 : H36-3D								
Mode 3 : H24M-3D	Mode 7 : H36M-3D								
Mode 4 : H36	Mode 8 : AUTO								
Mode 1 . FSS ® (Fast Speed Start)	Automatic capture most suitable EDID from Destination to Source.								
Mode 2 . H24-3D (1080p-24 bits)	Audio Support : PCM 2CH								
Mode 3 . H24M-3D (1080p-24bits)	Audio Support : MAT(MLP) 7.1CH, PCM 2CH, One Bit Audio 2CH, AC-3 5.1CH, DTS 5.1CH, PCM 7.1CH, Dolby Digital + 7.1CH, DTS-HD 7.1CH								
Mode 4 . H36 (1080p-36 bits)	Audio Support : PCM 2CH								
Mode 5 . H36M (1080p-36 bits)	Audio Support : MAT(MLP) 7.1CH, PCM 2CH, One Bit Audio 2CH, AC-3 5.1CH, DTS 5.1CH, PCM 7.1CH, Dolby Digital + 7.1CH, DTS-HD 7.1CH								
Mode 6 . H36-3D (1080p-36 bits)	Audio Support : PCM 2CH								
Mode 7 . H36M-3D (1080p-36 bits)	Audio Support : MAT(MLP) 7.1CH, PCM 2CH, One Bit Audio 2CH, AC-3 5.1CH, DTS 5.1CH, PCM 7.1CH, Dolby Digital + 7.1CH, DTS-HD 7.1CH								
Mode 8 . AUTO <Default>	All Outputs will be set to the highest common resolution of all connected display devices.								

EDID FUNCTION

EDID function for HDMI Matrix Switcher

6.2 LEARNING EDID	Learning EDID from Destination to Source
Learning EDID setup Press EDID > DESTINATION > SOURCE > ENTER	Switcher will LEARN destination EDID and pass the selected source.
<p>NOTE : The already learned EDID cannot be modified. You can only rebuild a new Learning EDID. For example; When the Source has "Learned" the EDID data from a destination, It will save that EDID information into EPROM and the EDID data cannot change. Please select new learning destination to sources or change to one of the embedded EDID modes when you want to remove the learning EDID memory from EPRPM.</p>	

6.2.1 Learning EDID Single to Single	Example : Learn Destination #2 EDID To Source #3.
Step 1 . Press EDID button	The button will flash blue and the display will show the current Embedded EDID Status.
Step 2 . Press the Destination #2 button row	Copy the Destination #2 Display EDID.
Step 3 . Press the Source #3 button row	Learning the Destination #2 EDID To Source # 3.
Step 4 . Press ENTER button	To confirm entries.

6.2.2 Learning EDID Single to multiple	Learning destination EDID link to the majority Sources
Step 1 . Press EDID button	The button will flash blue and the display will show the current Embedded EDID Status.
Step 2 . Press the Destinations #1~2 button row	Copy any 1~2 Destinations EDID.
Step 3 . Press the Source #1, #3,#4 button row	Learning the Destination EDID link to source #1,#3,#4 .
Step 4 . Press ENTER button	To confirm entries.

6.2.3 Learning EDID Single to ALL	Learning destination EDID link to All Sources
Step 1 . Press EDID button	The button will flash blue and the display will show the current Embedded EDID Status.
Step 2 . Press destination button 1 thru 2	Learning anyone 1~2 Destination EDID to all sources.
Step 3 . Press ALL button	Learning selected destination EDID to all sources.
Step 4 . Press ENTER button	To confirm entries.

EDID FUNCTION

EDID function for HDMI Matrix Switcher

6.3 EDID status	To view the current EDID status.
Step 1 . Press EDID button	The button will flash blue and the display will show the current Embedded EDID Status.
Step 2 . Press EDID button	To exit.

6.4 How to setup FSS[®] Function	<u>Fast speed start[®]</u>
Step 1 . Press the Destination #1~2 button row Then Press the Source #1~4 button row	To setup and Install all devices.
Step 2 . Press EDID button	Select a optimum status of Embedded EDID mode.
Step 3 . Press ENTER button	To conform entries.
Step 4 . Press EDID button	To select the EDID FSS[®] mode.
Step 5 . Press ENTER button	To conform entries.

6.5 LEARNING EDID definition	Learning EDID from Destination to Source
<ol style="list-style-type: none"> 1. Switcher will LEARN destination EDID and pass the selected source. 2. To set up learning between a single destination and single source: Press EDID button > Press Destination 1 thru 2 > Press Source 1 thru 4 > Press ENTER to confirm. Switcher will learn destination EDID to source device. 3. To set up learning between a single destination and Multiple sources: Press EDID button > Press Destination 1 thru 2 > Press the majority Sources 1 thru 4 > Press ENTER. Switcher will learn single destination EDID to many source devices. 4. How to Learning single destinations with all sources. Press EDID button > Press ALL button > Press ENTER to confirm. 	

6.6 Auto mode definition	Common Resolution and Audio
<p>Switcher will find highest common Resolution and Audio from all destination EDID to link Source.</p> <p>Example for single source Destination > press #1 and then Source > press #1 Destination device #1 will set to the highest <u>common</u> resolution and Audio of source #1</p> <p>Example for multiple sources Destination device #1, #2 will be set to the highest <u>common</u> resolution and Audio available and source device #1 will output this same resolution.</p>	

CONSUMER ELECTRONICS CONTROL (CEC)

CONSUMER ELECTRONIC CONTROL (CEC)

In brief, CEC allows HDMI devices to control each other when necessary and allows the user to operate multiple devices with one remote control handset.

To Enable CEC

- Press **EDID** button
- Press **ALL** button
- Press **EDID** button The pre-set configuration will execute.

To Disable CEC

- Press **EDID** button
- Press **OFF** button
- Press **EDID** button The pre-set configuration will execute.

Not all device support CEC. Check with your Users Guide for additional information and specifications.

To ensure stable operation, HDMI connections should only be made with switcher powered OFF.

FRONT PANEL

FRONT PANEL

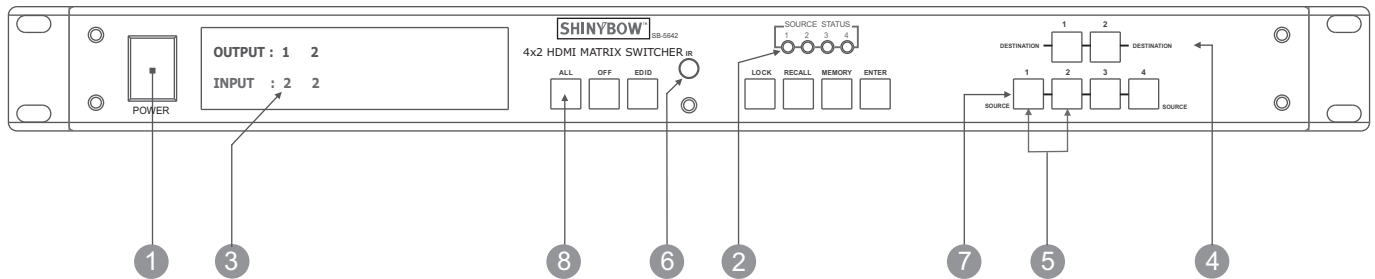

1 POWER SWITCH

The power switch turns the unit on and off. The LCM will illuminate red to indicate that the switcher is ON and is receiving power. The Switcher will remember that last state during a power cycle. When power is removed and resorted, the last configuration will be evoked.

2 INPUT STATUS DISPLAY

Input sources 1 to 4 LCM illuminates blue to indicate that a video source is present on that input.

3 OUTPUT STATUS DISPLAY

Each Output (destination) Channel shows which input (source) is assigned.

4 DESTINATION SELECT BUTTONS

Separate outputs 1 thru 2 select buttons are provided for each destination assignment. Routing can be Source to Destination or one source to multiple destinations. Example : Press Destination 1,2 then press Source 2 will route Input 2 to Output 1,2,4 respectively.

5 EDID MODE SELECT BUTTONS

Used to select EDID mode using Input buttons #1 and #2.

6 IR SENSOR

The IR sensor receives IR commands from the supplied remote controller or third party IR emitter.

7 SOURCE SELECT BUTTONS

Separate inputs 1 thru 4 select buttons are provided each source selection.

8 FUNCTION KEY - ALL

Disables (mute) video on all destinations OR Selects the same source to all destinations.

Option 1

- Press **ALL** followed by **OFF** button. The display will show " 0 " indicating all destinations have no video selected.

Option 2

- Press **ALL** followed by Source 1 thru 4. The display will show the Source selected.

- Press **ENTER** The pre-set source selection will be assigned all destinations.

FRONT PANEL

FRONT PANEL

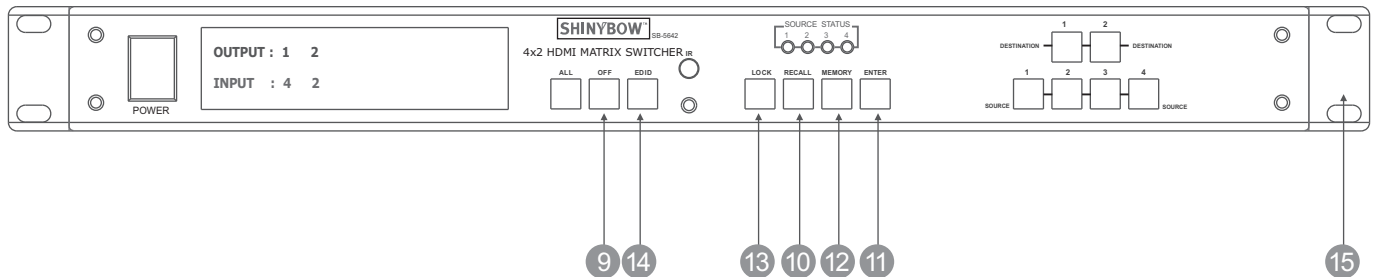

9 FUNCTION KEY - OFF

Disables (mute) video to selected channels. Either destinations.

- Press **OFF** button followed by any Destination channel.
- Press 1 thru 2 output destination. The display will show " 0 " for the selected channel indicating no video selected.

10 FUNCTION KEY - RECALL

The system will show previously stored presets, up to a total of 6.

Presets are stored in local memory using Source keys 1 thru 4 or Destination keys 1 thru 2 as the memory preset location.

- press **RECALL** button.
- press 1 thru 4 on either Source or Destination row.
- press **ENTER** The pre-set configuration will execute.

Operation completes.

Note: Operation will abort if no keys are dressed within 5 seconds.

11 FUNCTION KEY - ENTER

Press **ENTER** to confirm entries.

12 FUNCTION KEY - MEMORY

The system will show store presets, up to a total of 6.

Presets are stored in local memory using Source keys 1 thru 4 or Destination keys 1 thru 2 as the memory preset location.

- Configure desired matrices..
- Press **MEMORY** button.
- Press 1 thru 4 on either Source or Destination row.
- Press **ENTER** to ready memory location.

- or press **MEMORY** again to cancel operation.

Operation completes.

Note : Operation will abort if no keys are pressed within 5 seconds.

13 FUNCTION KEY - LOCK

- Press and hold **LOCK** button for two seconds lockout the front panel.
- Press and hold **LOCK** button for two seconds to enable the front panel.

14 FUNCTION KEY - EDID

- press **EDID** to select new EDID mode or select source row #1 or #2 for LINK source EDID again.

15 19 INCH EAR MOUNT PAIR

Converts desktop to 19 inch rack mount. Bracket (part # 1U-440L) INCLUDED.

Image shows rack mount bracket attached.

REAR PANEL

REAR PANEL

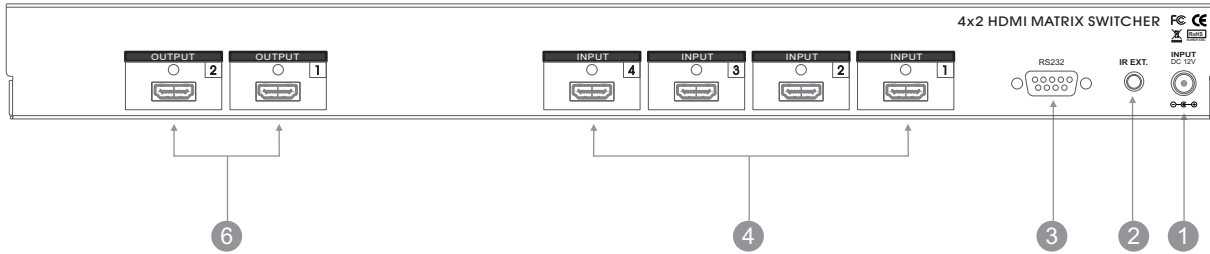

1 DC POWER INLET

The Switcher is fitted with a DC power plug input connector. Ensure that the used is of an approved type and is of sufficient current carrying connector capacity with the correct voltage and connector polarity. 12Volt DC power supply 3A Max (Center pin positive).



Power Jack:
DC Jack - inner OD ϕ 2.1mm (+)
Outside OD ϕ 5.5mm (GND)
Power input - 12VDC, 3A

2 IR EXTENDER CONTROL

Support one of IR Extender
Extend distance maximum 300Meters / ~1000 feet
When you plug the External IR extender into the switcher, the front panel IR receiver remain active.



IR Extender Jack:
Female Jack - inner OD ϕ 3.5 mm

3 RS 232 CONNECTION

RS 232 control port to allow for interfacing to a PC, Such as a computer or touch panel control, to the switcher via this DB-9pin Female connector for serial RS-232 control.

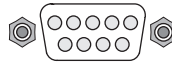

Remote port :
DB-9pin Female connector

4 INPUTS- 1,2,3, & 4 HDMI

Connect a signal link of HDMI direct digital video/audio to this Female HDMI connector. This connector supports HDMI digital video/audio and DVI digital video sources.

HDMI Digital Video/Audio, Connector with fix screw
Input 1 ~ Input 4

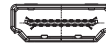

HDMI digital video/audio connector:
HDMI Female connector.
Note:
With the proper adapters, the switcher can be used with DVI digital video signals
HDCP compliant. DVI does not support audio.

5 OUTPUTS- 1 & 2 HDMI

Connect a signal link of HDMI direct digital video/audio to this Female HDMI connector. This connector supports HDMI digital video/audio and DVI digital video sources.

HDMI Digital Video/Audio, Connector with fix screw
Output 1 ~ Output 2



HDMI digital video/audio connector:
HDMI Female connector.
Note:
With the proper adapters, the switcher can be used with DVI digital video signals
HDCP compliant.

TYPICAL APPLICATION

INSTALLING DIAGRAM

4x2 HDMI MATRIX SWITCHER

Sample connection using IR Transmitters (SB-101) and IR Receiver (SB-100) with SB-6335T & SB-6335R to control a projector.

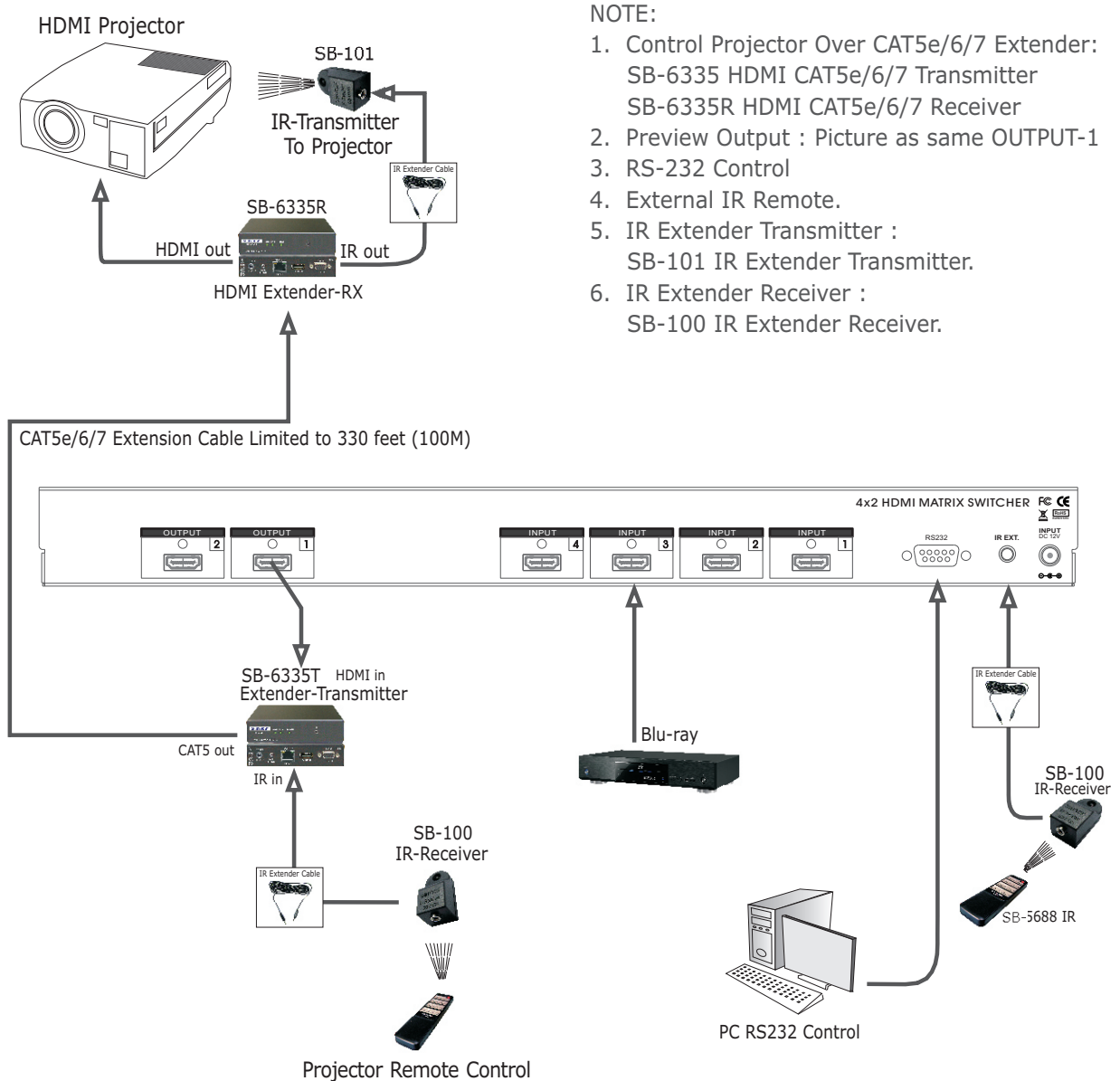

NOTE:

1. Control Projector Over CAT5e/6/7 Extender: SB-6335 HDMI CAT5e/6/7 Transmitter
SB-6335R HDMI CAT5e/6/7 Receiver
2. Preview Output : Picture as same OUTPUT-1
3. RS-232 Control
4. External IR Remote.
5. IR Extender Transmitter : SB-101 IR Extender Transmitter.
6. IR Extender Receiver : SB-100 IR Extender Receiver.

Support HDBaseT Extender by SB-6335 Transmitter and SB-6335R Receiver via CAT5e/6/7 cable

TYPICAL APPLICATION

INSTALLING DIAGRAM

4x2 HDMI MATRIX SWITCHER

Sample connection using IR Transmitters (SB-101) and IR Receivers (SB-100) with SB-6335T and SB-6335R to control a Satellite Receiver.

NOTE :

1. Control Satellite Receiver Over HDMI
CAT5e/6/7 Extender from room:
SB-6335T HDMI CAT5e/6/7 Transmitter
SB-6335R HDMI CAT5e/6/7 Receiver
2. Audio Extractor To Recode Audio :
SB-5609 HDMI Audio Extractor.
3. Control HDMI ARC:
SB-5610 ARC Control Box.
4. IR Extender Transmitter :
SB-101 IR Extender Transmitter.
5. IR Extender Receiver :
SB-100 IR Extender Receiver.

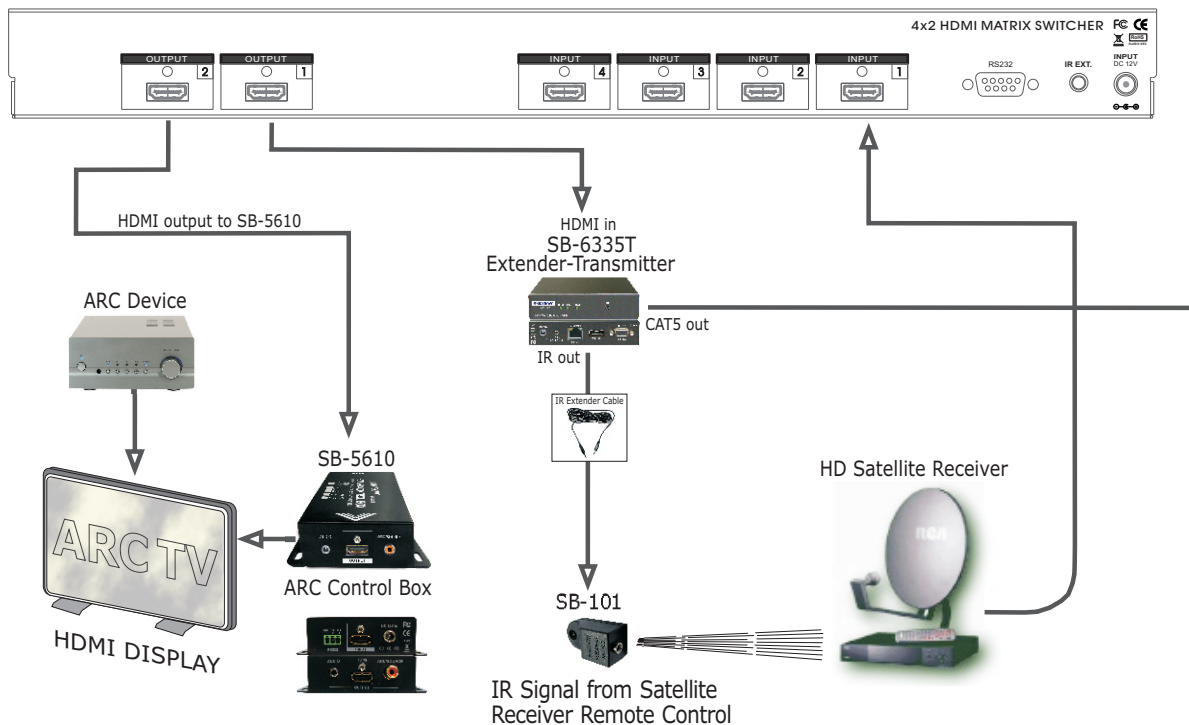
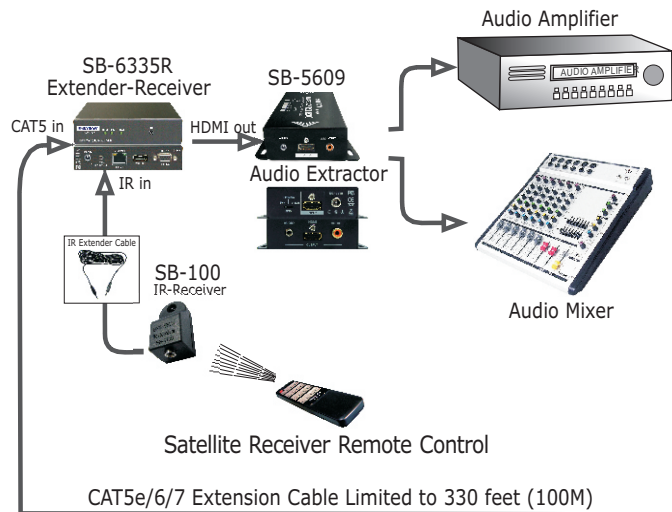

Support HDBaseT Extender by SB-6335 Transmitter and SB-6335R Receiver via CAT5e/6/7 cable

IR EXTENDER

REAR PANEL IR EXTENDER PORT

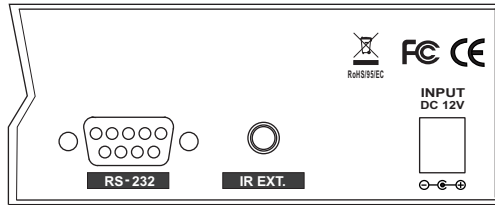

IR EXTENDER CONNECTION

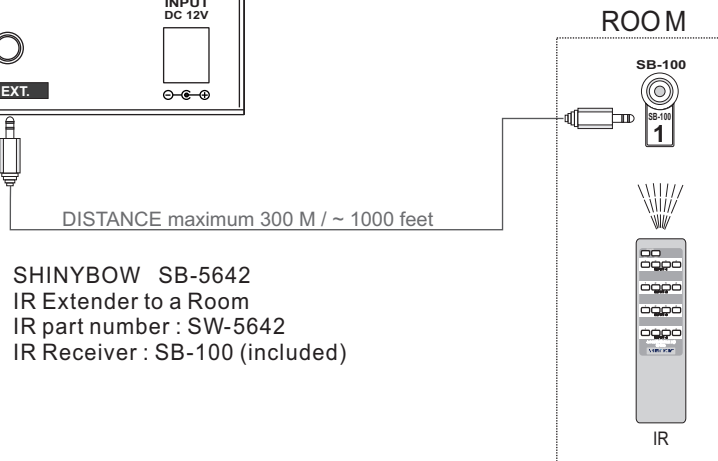

*** When you plug the External IR extender into the switcher, the front panel IR receiver remains active. ***

IR EXTENDER PACKAGE :

HOW TO SETUP THE IR EXTENDER COMPONENTS

Step 1

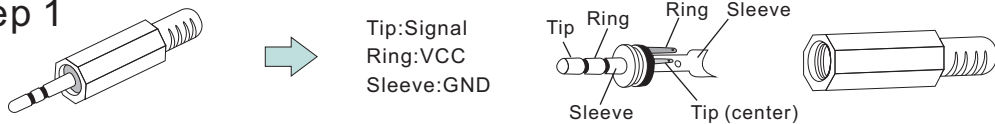

Step 2

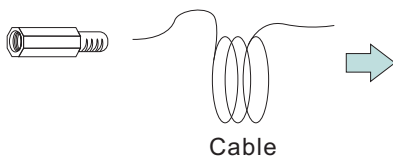

Step 3

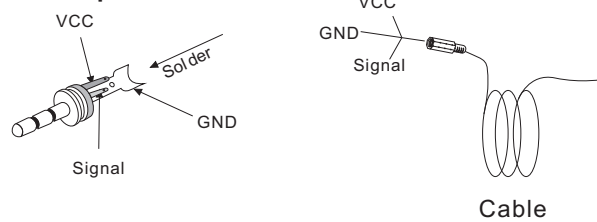

Switcher IR EXT. In

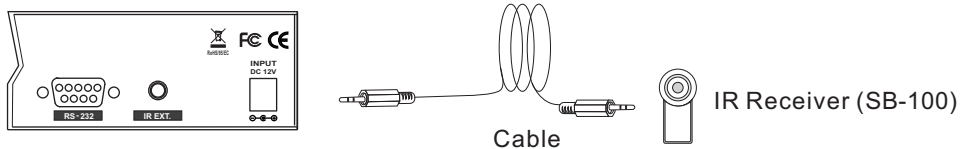

REMOTE CONTROL

Before making any connections to the switcher. Observe the following:

- > Ensure the mains voltage supply matches the label on the supplied plug-Pack (+/- 10%)
- > Ensure that the power switch is OFF
- > Ensure that all system grounds (earth) are connected to a common point.
- > Avoid powering equipment within a system from multiple power sources that may be separated by large distances
- > Connect all audio video sources and destination equipment
- > power up all source and destination audio-visual sources
- > For each destination output select the appropriate input source by using The front panel input 1~8 select buttons. The supplied IR remote control. Or through the RS 232 serial communications port.
- > Upon power up the switcher will return to its last used setting before Powered down.

REMOTE CONTROL

IR REMOTE : SW-5642

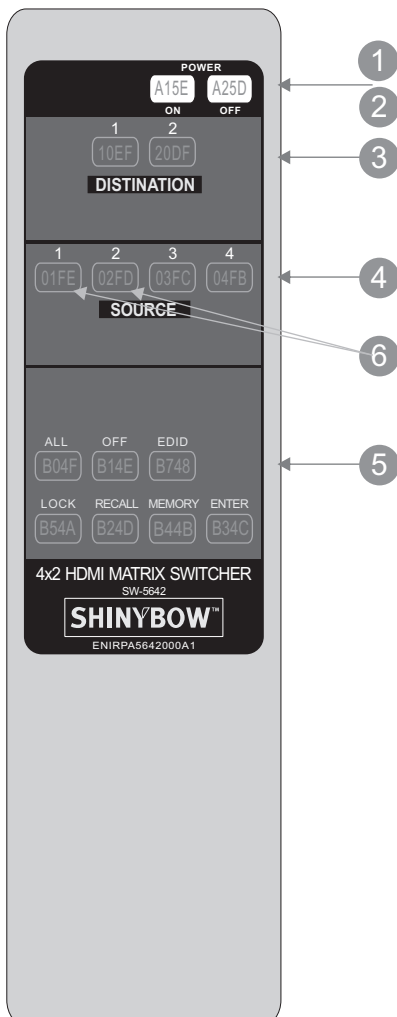

IR REMOTE CONTROL KEY :

- 1 2 SWITCH POWER ON or OFF
Controller with a separate power ON and OFF
- 3 DESTINATION : 1 thru 2 OUTPUT SELECTION
Press the destination button to select the output display channel.
- 4 SOURCE : 1 thru 4 INPUT SOURCE SELECTION
Press input 1~4 sources with selection button
- 5 FUNCTION KEY
ALL - function selection button
DEMO or ENTER - function selection button
EDID - function selection button
LOCK - function selection button
- 6 SELECT EDID MODES : press source button 1 thru 2.
 - 1 Mode 1 : **FSS** (Fast Speed Start)
 - 2 Mode 2 : **H24-3D**
 - 3 Mode 3 : **H24M-3D**
 - 4 Mode 4 : **H36**
 - 5 Mode 5 : **H36M**
 - 6 Mode 6 : **H36-3D**
 - 7 Mode 7 : **H36M-3D**
 - 8 Mode 8 : **AUTO**

REMOTE CONTROL

IR REMOTE CUSTOM AND DATA CODES (NEC Standard)

HOW TO SETUP IR CODES :

CUSTOM CODE : 1C E3	ALL	: 1BE4 B04F
<u>DATA CODE</u> :	OFF	: 1BE4 B14E
POWER ON : 1BE4 A15E	EDID	: 1BE4 B748
POWER OFF : 1BE4 A25D	LOCK	: 1BE4 B54A
	RECALL	: 1BE4 B24D
	MEMORY	: 1BE4 B44B
	ENTER	: 1BE4 B34C

PRESS TV DESTINATION - # then PRES AV SOURCE -

DESTINATION #1 : 1BE4 10EF
DESTINATION #2 : 1BE4 20DF

SOURCE #1 : 1BE4 01FE
SOURCE #2 : 1BE4 02FD
SOURCE #3 : 1BE4 03FC
SOURCE #4 : 1BE4 04FB

For example;
Select Destination # 1 to show Source #1~4,

The IR Data Code list :

Destination # 1 , Source #1	1BE4	10EF	1BE4	01FE
Destination # 1 , Source #2	1BE4	10EF	1BE4	02FD
Destination # 1 , Source #3	1BE4	10EF	1BE4	03FC
Destination # 1 , Source #4	1BE4	10EF	1BE4	04FB

Press EDID Mode key :

Mode 1 : FSS	: 1BE4	E01F
Mode 2 : H24-3D	: 1BE4	E11E
Mode 3 : H24M-3D	: 1BE4	E21D
Mode 4 : H36	: 1BE4	E31C
Mode 5 : H36M	: 1BE4	E41B
Mode 6 : H36-3D	: 1BE4	E51A
Mode 7 : H36M-3D	: 1BE4	E619
Mode 8 : AUTO	: 1BE4	E718

RS-232 SERIAL INTERFACE

RS-232 SERIAL INTERFACE CONNECT a PC or CONTROL SYSTEM. VERSION COMPATIBLE V2.0.1

For a complete list of commands, please reference external document extended RS-232 Protocol Instruction Manual.

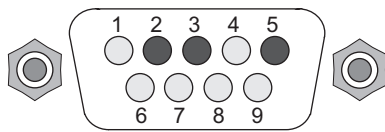

RS-232 SERIAL INTERFACE

Pin	RS-232	Definition
1	-----	Not used
2	TX	Transmitter
3	RX	Receiver
4	-----	Not used
5	GND	Ground
6	-----	Not used
7	-----	Not used
8	-----	Not used
9	-----	Not used

RS-232 PROTOCOL COMMANDS (RS232 Control driver V2.0.1)

The Shinybow switcher can be controlled via the RS-232 serial control port to allow for interfacing to a PC, or similar third party control system.

The serial communication parameters are 9600 baud, 8 bit, No Parity and 1 stop bit - this is often referred to as 9600 8N1. When the unit recognises a complete command it will perform the requested action - there is no delimiter character required.

0 = the number

0 = the letter

LIMITED WARRANTY

LIMITED WARRANTY

SHINYBOW WARRANTY

SHINYBOW Technology warrants this product against defects in materials and workmanship for a period of 3 years from the date of purchase.

Should this product, in SHINYBOW Technology's opinion, prove defective within this warranty period, SHINYBOW Technology, at its option, will repair this product without charge, to whatever extent it shall deem necessary to restore said product to proper operation condition. This does not extend the warranty period.

This warranty does not apply if the fault has been caused by misuse, improper handling care, electrical or mechanical abuse, and abnormal operating condition or non-SHINYBOW Technology authorized modification to the product.

If repairs are necessary under the warranty policy, the original purchaser must return the product to local distributor, freight prepaid.

After repairs are complete, the product will be returned.

REGULATORY COMPLIANCE

The product complies with the relevant standards for CE, FCC and RoHS approval.

The power Adaptor/Supply has been tested for compliance with UL.CSA and CE standards.

TROUBLESHOOTING

If you experience a <no signal> with this switcher or distributor outputs, first make certain that the signal being fed to its inputs is acceptable.

Disconnect the cables from the this switcher or distributor inputs and connect them directly to an appropriate monitoring device, if you do not see or hear a signal the problem may well be the signal source itself. Also check that the AC outlet you have used to power the switcher or distributor is actually providing power as a wall switch often controls an AC outlet.

The second most common problem with this switcher or distributor revolves around the cables, inspect the cables for loose connectors or cable damage such as crushed cable or cables with cuts or nicks. Replace any cable exhibiting these problem.

You also must use the highest quality cables if you want to achieve the best results. Poor quality cables provide will poor quality signals.

SHINYBOW™ USA

MULTIMEDIA AUDIO AND VISUAL
