



DVI 3600 HD Extender

EXT-DVI-3600HD
User Manual



www.gefen.com

ASKING FOR ASSISTANCE

Technical Support:

Telephone (818) 772-9100
(800) 545-6900

Fax (818) 772-9120

Technical Support Hours:

8:00 AM to 5:00 PM Monday through Friday, Pacific Time

Write To:

Gefen Inc.
c/o Customer Service
20600 Nordhoff St
Chatsworth, CA 91311

www.gefen.com
support@gefen.com

Notice

Gefen LLC reserves the right to make changes in the hardware, packaging and any accompanying documentation without prior written notice.

DVI 3600 HD is a trademark of Gefen LLC

CONTENTS

- 1 Introduction
- 2 Operation Notes
- 3 Features
- 4 Sender Panel Layout
- 5 Sender Panel Descriptions
- 7 Receiver Panel Layout
- 8 Receiver Panel Descriptions
- 10 Connecting the DVI 2600HD
- 11 Wiring Diagram
- 12 Operating the DVI 3600 HD
- 12 Virtual EDID Programming Procedure
- 13 Operating Modes
- 14 Specifications
- 15 Warranty

INTRODUCTION

Congratulations on your purchase of the DVI 3600 HD. Your complete satisfaction is very important to us.

Gefen

Gefen delivers innovative, progressive computer and electronics add-on solutions that harness integration, extension, distribution and conversion technologies. Gefen's reliable, plug-and-play products supplement cross-platform computer systems, professional audio/video environments and HDTV systems of all sizes with hard-working solutions that are easy to implement and simple to operate.

The Gefen DVI 3600 HD

The DVI 3600 HD allows you to operate a single DVI-compliant computer from two workstations, by extending DVI, USB 2.0, analog audio, and RS-232 from the computer to the remote workstation. USB peripherals can be placed at either of the two locations, by the Sender or Receiver unit.

How It Works

The DVI 3600 HD system consists of a Sender and a Receiver unit. The Sender connects to the computer's DVI-compliant video card output, analog audio jack, RS-232 port, and USB port. The DVI 3600 HD Receiver connects to the remote display and peripherals. Four strands of LC fiber optic cable connect the Sender and Receiver together.

The DVI 3600 HD has two modes of USB operation. When in local mode, the computer sees USB devices connected to the Sender. When in remote mode, the computer sees USB devices connected to the Receiver. Modes are switched using a switch on the front panel of the Sender.

OPERATION NOTES

READ THESE NOTES BEFORE INSTALLING OR OPERATING THE DVI 3600 HD

CLASS 1 LASER PRODUCT

- LC terminated fiber optic cables (2 pairs) are required for operation of the DVI 3600 HD system.
- The DVI 3600 HD relies on either Virtual DDC or a locally connected display (on the sender unit) for display information (EDID). In Virtual DDC mode the Sender unit will store the remotely connected display's EDID. This EDID will need to be recorded onto the sender unit. See page 12 for instructions on using the Virtual DDC feature.
- When using a local display, ensure that the remote display can display common resolutions and timings that are in the EDID of the local display. The reverse applies when using the Virtual DDC mode: The local display in Virtual DDC mode must be able to accept common resolutions and timings that are in the EDID of the remote display.
- This device will accept both singlemode and multimode fiber optic cables.
- This device will accept both 50µm and 62.5µm multi-mode fiber optic cable types.
- Maximum extension with singlemode fiber optic cable is 6,600 feet (2 kilometers) at 1920 x 1200 (WUXGA).
- Maximum extension with multimode fiber optic cable is 1,650 feet (500 meters) at 1920 x 1200 (WUXGA).

FEATURES

Features

- Extends DVI up to 6,600 feet (2000 meters) with singlemode
- Extends DVI up to 1,650 feet (500 meters) with multimode along with USB, analog audio, and RS-232
- Supports video resolutions up to 1920 x 1200
- Uses four-strand multi-mode LC terminated fiber cables
- Supports Virtual DDC and DDC2B protocols
- Supports DDWG standards for DVI compliant monitors
- Supports USB 2.0 and USB 1.1
- USB can be switched between the local computer and the remote workstation
- Rack-mountable

Package Includes

- (1) DVI 3600 HD - Sender unit
- (1) DVI 3600 HD - Receiver unit
- (1) 6 ft. Dual-link DVI cable (M-M)
- (1) 6 ft. USB cable (A-B)
- (1) 6 ft. RS-232 cable (M-F)
- (2) 12V power supply
- (1) Quick Start Guide

SENDER PANEL LAYOUT

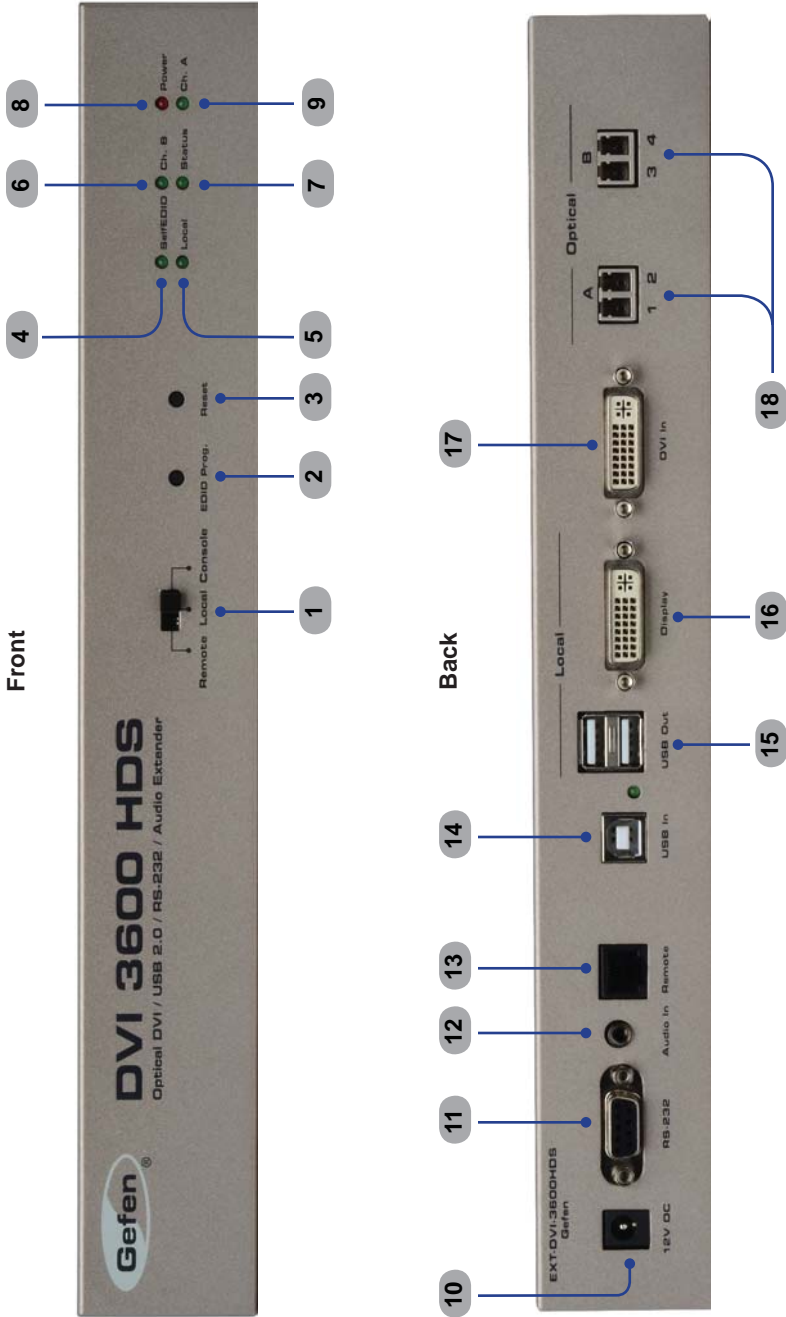

SENDER PANEL DESCRIPTIONS

1 **Remote / Local / Console**

This switch will allow the user to select which location has USB control. See page 13 for more information.

2 **EDID Prog.**

This button will begin the EDID recording process for use of the Virtual DDC mode. See page 12 for information on using the Virtual DDC feature.

3 **Reset**

This button is used to cycle the power off and on. In most cases this will force the source to re-establish a link with the endpoint device. This will also force the source to re-read the EDID.

4 **SelfEDID**

This LED indicator will be used when recording the EDID for the Virtual DDC mode. See page 12 for information on using the Virtual DDC feature.

5 **Local**

This LED indicator will glow bright green when the USB control is set to the Local setting (using the **Control Switch**). When this LED is active, the USB ports located on the Sender unit will be active and the USB ports on the Receiver unit will be disabled.

6 **Ch B**

This LED indicator will glow bright green when a valid optical link exists between channel B (LC-fiber connectors) on the Sender unit and channel B on the Receiver unit. See #18.

7 **Status**

This LED indicator will glow bright green when all devices are properly connected and that both the Sender and Receiver unit are working properly.

8 **Power**

This LED indicator will glow bright red once the included 12V DC power supply has been properly connected between the Sender unit and an available electrical outlet.

9 **Ch A**

This LED indicator will glow bright green when a valid optical link exists between channel A (LC-fiber connectors) on the Sender unit and channel A on the Receiver unit. See #18.

10 **12V DC**

Connect the included 12V DC power supply to this power receptacle.

11 **RS-232**

Connects to the RS-232 control device. The *DVI 3600 HD* may be controlled remotely using this port.

SENDER PANEL DESCRIPTIONS

12 Audio In

Connect a 3.5mm mini-stereo cable from the audio source to this jack.

13 Remote

Reserved for future use. This port is not used.

14 USB In

Use the included USB cable to connect the computer to this port. This port will accept USB 2.0 and USB 1.1 host devices. USB devices can be connected to the local and remote USB ports. While all ports are available for device input, only one location, local or remote, can be active at any given time. To switch control between locations, use the control switch located on the front panel of the Sender unit.

15 USB Out

Connect up to two USB devices to these ports.

16 Display

Connect a local DVI display to this port. This port is always active and duplicates the video input signal on the Sender unit.

17 DVI In

Connect a DVI source to this port.

18 Optical A / B

Each channel (A and B) accepts 2 pairs of LC-terminated fiber optic cable. Connect each pair of LC-terminated fiber optic cables from the Sender unit to the Receiver unit. Make sure each pair of fiber optic cables are connected from the Sender unit to the corresponding LC fiber optic connectors on the Receiver unit.

RECEIVER PANEL LAYOUT

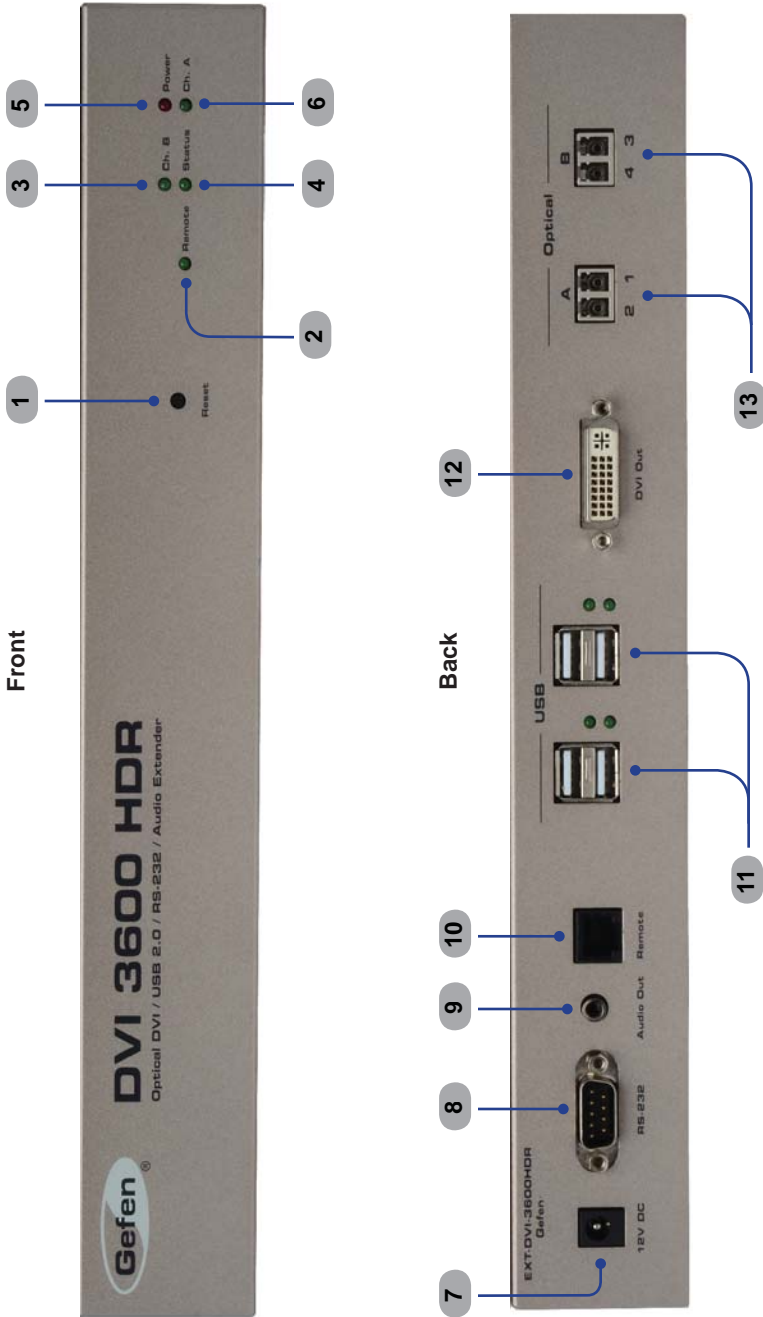

RECEIVER PANEL DESCRIPTIONS

1 **Reset**

This button is used to cycle the power off and on. In most cases this will force the source to re-establish a link with the endpoint device. This will also force the source to re-read the EDID.

2 **Remote**

This LED indicator will glow bright green when USB control is set to Remote mode (see page 13). When this LED is active, the USB ports on the Receiver unit will be active and the USB ports on the Sender unit will be disabled.

3 **Ch B**

This LED indicator will glow bright green when a valid optical link exists between channel B (LC-fiber connectors) on the Sender unit and channel B on the Receiver unit. See #18.

4 **Status**

This LED indicator will glow bright green when all devices are properly connected and that both the Sender and Receiver unit are working properly.

5 **Power**

This LED indicator will glow bright red once the included 12V DC power supply has been properly connected between the Sender unit and an available electrical outlet.

6 **Ch A**

This LED indicator will glow bright green when a valid optical link exists between channel A (LC-fiber connectors) on the Sender unit and channel A on the Receiver unit. See #18.

7 **12V DC**

Connect the included 12V DC power supply to this power receptacle.

8 **RS-232**

Connects to the RS-232 control device. The *DVI 3600 HD* may be controlled remotely using this port.

9 **Audio Out**

Connect an audio/video device to this jack using a 3.5mm mini-stereo cable.

10 **Remote**

Reserved for future use. This port is not used.

11 **USB**

Connect up to four USB devices to these ports. These USB ports are active only when the control switch is set to **Remote**.

RECEIVER PANEL DESCRIPTIONS

12 DVI Out

Connect a DVI display to this connector.

13 Optical A / B

Each channel (A and B) accepts 2 pairs of LC-terminated fiber optic cable. Connect each pair of LC-terminated fiber optic cables from the Sender unit to the Receiver unit. Make sure each pair of fiber optic cables are connected from the Sender unit to the corresponding LC fiber optic connectors on the Receiver unit.

CONNECTING THE DVI 3600 HD

How to Connect the GefenPRO 8x8 DVIKVM Dual Link Matrix



STOP: The *DVI 3600 HD* can use a local EDID or a virtual EDID. To use a local EDID, a display must be connected to the Sender unit at all times, before powering the *DVI 3600 HD*. If the EDID of the remote display (virtual EDID) is to be used, then follow the instructions on page 12 before continuing. After a virtual EDID has been programmed, a local display can be connected to the Sender unit, if desired.

1. Use the included DVI cable to connect the DVI source to the *DVI In* connector on the *DVI 3600 HD* Sender unit.
2. OPTIONAL: Connect a local DVI display to the *Display* connector on the *DVI 3600 HD* Sender unit.
3. Connect the included USB cable between the USB host device and the *DVI 3600 HD* Sender unit.
4. Connect up to two USB devices to the USB Out ports on the Sender unit. These USB devices can only be used if the *DVI 3600 HD* is set to *Local* mode. See page 13 for more information on operating modes.
5. Use the included mini-stereo cable to connect the audio source to the *Audio In* jack on the *DVI 3600 HD* Sender unit.
6. Connect a DVI cable from the display to the *DVI Out* connector on the *DVI 3600 HD* Receiver unit.
7. Connect up to four USB devices to the USB outputs on the *DVI 3600 HD* Receiver unit.
8. Connect a mini-stereo cable between the audio/video device and the *Audio Out* jack on the *DVI 3600 HD* Receiver unit.
9. Connect two pairs of LC-terminated fiber optic cable between the *DVI 3600 HD* Sender unit and Receiver unit.
10. OPTIONAL: Connect an RS-232 cable from the Receiver unit to the RS-232 control device.
11. Connect the included 12V DC power supplies to both the *DVI 3600 HD* Sender unit and Receiver unit.
12. Connect the included AC power cables between each power supply and an available electrical outlet.

CONNECTING THE DVI 3600 HD



IMPORTANT: When connecting the fiber optical cables, ensure that each of the fiber optical cables are connected in the correct order, between the Sender and Receiver unit (1 to 1, 2 to 2, 3 to 3, and 4 to 4) as shown below.

Sender unit

Receiver unit

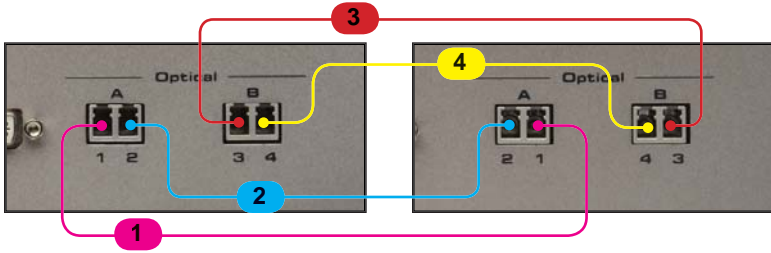

Wiring Diagram for the DVI 3600 HD

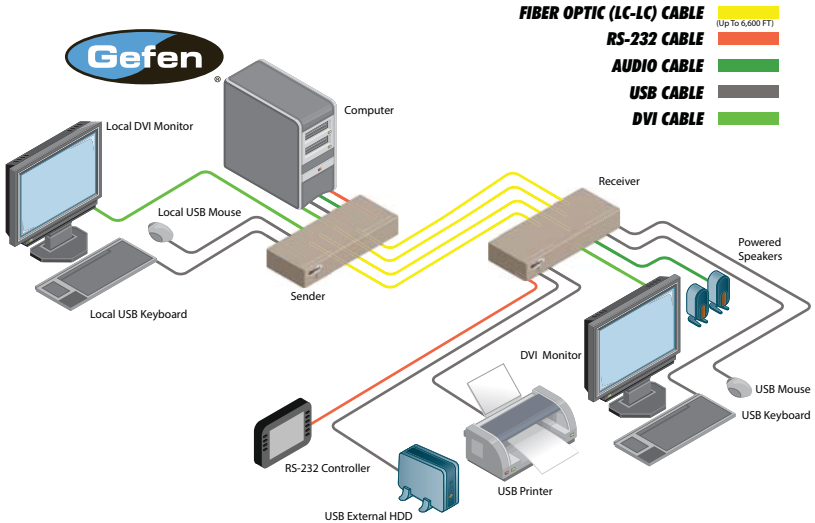

EXT-DVI-3600HD

OPERATING THE DVI 3600 HD

Virtual EDID Programming Procedure

Virtual DDC mode is the process of recording an EDID from a specified display. This EDID will be stored and used by the Sender unit to send the correct display information to the source device.

1. Make sure that there are no USB, audio, or DVI cables are connected to the *DVI 3600 HD* Sender unit. The power supply should not be connected.
2. Use a DVI cable to connect the *DVI 3600 HD* Sender unit to the display at the remote location (the display that will normally be used to connect to the Receiver unit).
3. Power the display.
4. Connect one of the included 12V DC power supplies to the *DVI 3600 HD* Sender unit.
5. Connect the 5V DC power supply to the power receptacle of the Sender unit. Make sure that the Power LED is ON and that the Status LED is blinking slowly.
6. Press and release the *EDID Prog* button on the Sender unit using a small pointed object. The *SelfEDID* LED indicator will flash rapidly for approximately eight seconds. Once the EDID has been successfully recorded, the *SelfEDID* LED indicator will turn off.

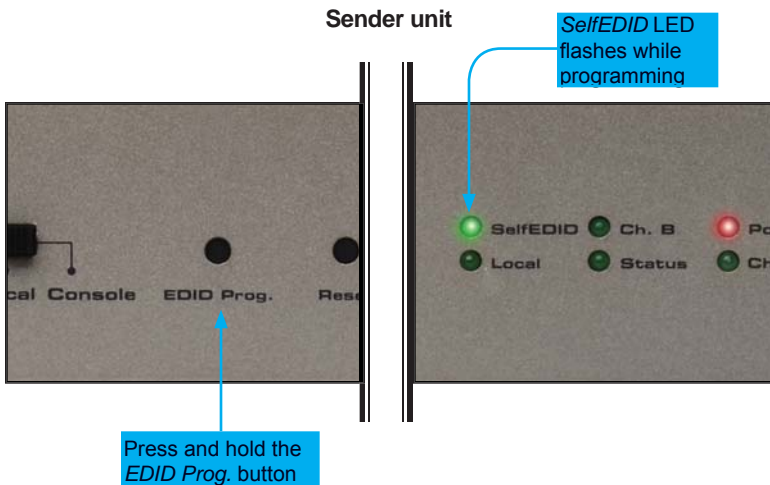

7. Disconnect the display and power from the *DVI 3600 HD* Sender unit.
8. Connect the *DVI 3600 HD* Sender and Receiver unit as outlined on pages 10 and 11.

OPERATING THE DVI 3600 HD

Operating Modes

The front panel of the *DVI 3600 HD* Sender unit has a control switch that determines the location of the active USB ports. The control switch does not affect the DVI outputs. The *console* mode setting is not used.

Local

Set the control switch to *Local* to access USB control from the Sender unit. Any USB devices connected to the Receiver unit are disabled.

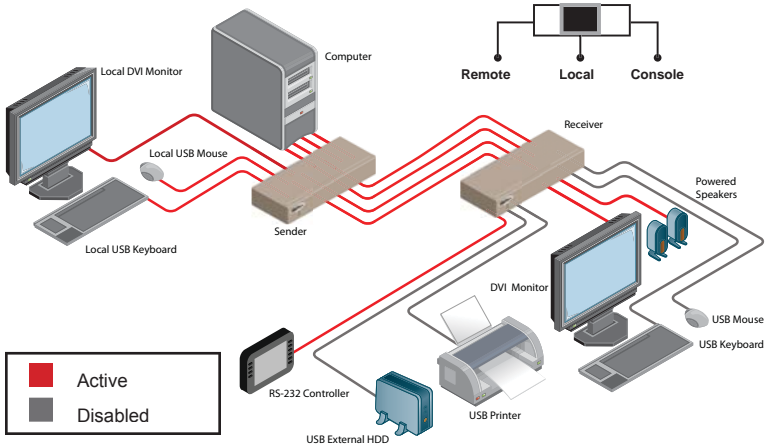

Remote

Set the control switch to *Remote* to access USB control from the Receiver unit. Any USB devices connected to the Sender unit are disabled.

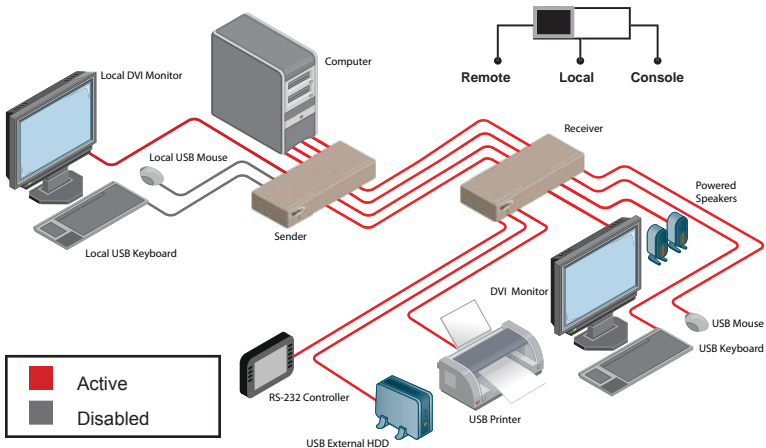

SPECIFICATIONS

Maximum Pixel Clock.....	165 MHz
Video Input Connector (Sender).....	(1) DVI-D (24 pin), female (digital only)
Video Output Connector (Sender).....	(1) DVI-D (24 pin), female (digital only)
Video Output Connector (Receiver).....	(1) DVI-D (24 pin), female (digital only)
Audio Input Connector (Sender).....	(1) 3.5 mm mini-stereo jack
Audio Output Connector (Receiver).....	(1) 3.5 mm mini-stereo jack
USB Host Connector (Sender).....	(1) USB Type B
USB Device Connectors (Sender).....	(2) USB Type A, female
USB Device Connectors (Receiver).....	(4) USB Type A, female
USB Maximum Bandwidth.....	480 Mbps
RS-232 Port (Sender).....	(1) DB-9, female
RS-232 Port (Receiver).....	(1) DB-9, male
Link Connectors (Sender / Receiver).....	(4) Type LC
Remote Connector (Sender / Receiver).....	(1) RJ-11 (reserved for future use)
Power Supply (Sender / Receiver).....	(1) 12V DC
Power Consumption.....	36W (max.) each
Dimensions (W x D x H) (Sender / Receiver).....	12.4" x 5" x 1.6" (315mm x 127mm x 41mm)
Shipping Weight.....	8 lbs. (3.6 kg)

WARRANTY

Gefen warrants the equipment it manufactures to be free from defects in material and workmanship.

If equipment fails because of such defects and Gefen is notified within two (2) years from the date of shipment, Gefen will, at its option, repair or replace the equipment, provided that the equipment has not been subjected to mechanical, electrical, or other abuse or modifications. Equipment that fails under conditions other than those covered will be repaired at the current price of parts and labor in effect at the time of repair. Such repairs are warranted for ninety (90) days from the day of reshipment to the Buyer.

This warranty is in lieu of all other warranties expressed or implied, including without limitation, any implied warranty or merchantability or fitness for any particular purpose, all of which are expressly disclaimed.

1. Proof of sale may be required in order to claim warranty.
2. Customers outside the US are responsible for shipping charges to and from Gefen.
3. Copper cables are limited to a 30 day warranty and cables must be in their original condition.

The information in this manual has been carefully checked and is believed to be accurate. However, Gefen assumes no responsibility for any inaccuracies that may be contained in this manual. In no event will Gefen be liable for direct, indirect, special, incidental, or consequential damages resulting from any defect or omission in this manual, even if advised of the possibility of such damages. The technical information contained herein regarding the features and specifications is subject to change without notice.

For the latest warranty coverage information, refer to the Warranty and Return Policy under the Support section of the Gefen Web site at www.gefen.com.

PRODUCT REGISTRATION

Please register your product online by visiting the Register Product page under the Support section of the Gefen Web site.



20600 Nordhoff St., Chatsworth CA 91311
1-800-545-6900 818-772-9100 fax: 818-772-9120
www.gefen.com support@gefen.com



This product uses UL or CE listed power supplies.